



EUROPEAN COMMISSION

Integrated Pollution Prevention and Control (IPPC)

**Reference Document on the application of Best Available
Techniques to Industrial Cooling Systems**

December 2001

EXECUTIVE SUMMARY

This reference document on the application of best available techniques to industrial cooling systems (BREF) reflects the information exchange carried out according to Article 16 (2) of Council Directive 96/61/EC on IPPC. The document has to be seen in the light of the preface that describes the objective of the document and its use.

In the framework of IPPC, industrial cooling has been identified as a horizontal issue. It means that “Best Available Techniques”(BAT) in this document is assessed without an in-depth assessment of the industrial process to be cooled. Notwithstanding, BAT for a cooling system is considered within the cooling requirements of the industrial process. It is acknowledged that BAT for cooling a process is a complex matter balancing the cooling requirements of the process, the site-specific factors and the environmental requirements, which allows implementation under economically and technically viable conditions.

The term “industrial cooling systems” refers to systems to remove excess heat from any medium, using heat exchange with water and/or air to bring down the temperature of that medium towards ambient levels.

In this document, BAT is described for cooling systems that are considered to work as auxiliary systems for the normal operation of an industrial process. It is acknowledged that reliable operation of a cooling system will positively affect the reliability of the industrial process. However, the operation of a cooling system in relation to process safety is not covered in this BREF.

This document presents an integrated approach to arrive at BAT for industrial cooling systems acknowledging that the final BAT solution is mainly a site-specific matter. With respect to the selection of a cooling system, this approach can only discuss which elements are linked to the environmental performance of the cooling system, rather than select and (dis) qualify any of the applied cooling systems. Where reduction measures are applied, the BAT approach attempts to highlight the associated cross-media effects thus emphasising that reduction of the different emissions of cooling systems needs balancing.

The five chapters of the main document describe the BAT approach, its key issues and principles, the cooling systems and their environmental aspects, the key BAT findings and the conclusions and recommendations for further work. Eleven annexes give background information addressing specific aspects of designing and operating cooling systems and examples to illustrate the BAT approach.

1. Integrated approach

The integrated BAT approach considers the environmental performance of the cooling system in the context of the overall environmental performance of an industrial process. It aims at minimisation of both the indirect and direct impacts of the operation of a cooling system. It is based on the experience that the environmental performance of cooling of a process largely depends on selection and design of the cooling system. Therefore, for new installations the approach focuses on prevention of emissions by selection of an adequate cooling configuration and by proper design and construction of the cooling system. Additionally, reduced emissions are achieved by optimization of daily operation.

For existing cooling systems there is on a short term less potential for prevention by technological measures and emphasis is on emission reduction by optimized operation and systems control. For existing systems a large number of parameters, such as space, availability of operating resources and existing legislative restrictions, may be fixed and leave few degrees

of freedom to change. However, the general BAT approach in this document can be considered as a long-term goal, which fits with equipment replacements cycles for existing installations.

The BAT approach acknowledges that cooling is an essential part of many industrial processes and should be seen as an important element in the overall energy management system. The efficient use of energy in industrial processes is very important from the environmental and cost-efficiency points of view. First of all, BAT means that attention must be paid to the overall energy efficiency of the industrial or manufacturing process, before measures are taken to optimize the cooling system. To increase overall energy efficiency, industry aims to reduce the amount of non-recoverable heat by applying proper management of energy and by adopting a range of integrated energy-saving programmes. This includes energy exchange between different units inside the cooled industrial or manufacturing process as well as links outside this process with adjacent processes. There is a tendency towards a concept of heat recovery for industrial regions when industrial sites are interlinked or are linked with district heating or greenhouse farming. Where no further recovery and re-use of this heat is possible, it may have to be released into the environment.

Distinction is made between low level (10-25°C), medium level (25-60°C) and high level (60°C) non-recoverable heat. In general, wet cooling systems are applied for low level heat and dry cooling systems for high level heat. For the medium level no single cooling principle is preferred and different configurations can be found.

After optimization of the overall energy efficiency of the industrial or manufacturing process a given amount and level of non-recoverable heat remains and a first selection for a cooling configuration to dissipate this heat can be made balancing:

- the cooling requirements of the process,
- the site limitations (including local legislation) and
- the environmental requirements.

The cooling requirements of the industrial or manufacturing process must always be met to ensure reliable process conditions, including start-up and shut down. The required minimum process temperature and the required cooling capacity must be guaranteed at all times so as to enhance the efficiency of the industrial or manufacturing process and reduce the loss of product and emissions to the environment. The more temperature sensitive these processes, the more important this will be.

Site conditions limit the design options and the possible ways a cooling system can be operated. They are defined by the local climate, by the availability of water for cooling and discharge, by the available space for constructions and by the sensitivity of the surrounding area to emissions. Depending on the process demands on cooling and the required cooling capacity, site selection for a new installation can be very important (e.g. large cold water source). Where the choice for a site is driven by other criteria or in the case of existing cooling systems, the cooling requirements of the process and the site characteristics are fixed.

For cooling, the local climate is important, as it affects the temperature of the ultimate coolant water and air. The local climate is characterised by the pattern of wet and dry bulb temperatures. In general, cooling systems are designed to fulfil the cooling requirements under the least favourable climatic conditions that can occur locally, i.e. with highest wet and dry bulb temperatures.

The next step in the selection and design of the cooling system aims to meet the BAT requirements, within the requirements of the process to be cooled and the site limits. This means that emphasis here is on the selection of adequate material and equipment to reduce maintenance requirements, to facilitate operation of the cooling system and the realisation of environmental requirements. Besides the release of heat into the environments other environmental effects can occur such as the emission of additives used for conditioning of

cooling systems. It is emphasized that where the amount and level of heat to be dissipated can be reduced, the resulting environmental impact of the industrial cooling system will be lower. The principles of the BAT approach can also be applied to existing cooling systems. Technological options may be available, such as a change of cooling technology, or a change or modification of existing equipment or chemicals used, but they can only be applied to a limited extent.

2. Applied cooling systems

Cooling systems are based on thermodynamic principles and are designed to promote the heat exchange between process and coolant and to facilitate the release of non-recoverable heat into the environment. Industrial cooling systems can be categorized by their design and by the main cooling principle: using water or air, or a combination of water and air as coolants.

The exchange of heat between process medium and coolant is enhanced by heat exchangers. From the heat exchangers the coolant transports the heat into the environment. In open systems the coolant is in contact with the environment. In closed systems the coolant or process medium circulates inside tubes or coils and is not in open contact with the environment.

Once-through systems are commonly applied to large capacity installations in locations where sufficient cooling water and receiving surface water are available. If a reliable water source is not available, recirculating systems (cooling towers) are used.

In open recirculating towers, cooling water is cooled down by contact with a airstream. Towers are equipped with devices to enhance the air/water contact. The airflow can be created by mechanical draught using fans or by natural draught. The mechanical draught towers are used widely for small and large capacities. Natural draught towers mostly are applied for large capacities (e.g. power industry).

In closed circuit systems the tubes or coils in which the coolant or process medium circulates are cooled, in turn cooling the substance they contain. In wet systems an airflow cools by evaporation the tubes or coils which are sprayed with water. In dry systems only an airflow passes the tubes/coils. In both designs coils can be equipped with fins, enlarging the cooling surface and thus the cooling effect. Closed circuit wet systems are widely used in industry for smaller capacities. The principle of dry air-cooling can be found in smaller industrial as well as in large power plant applications in those situations where sufficient water is not available or water is very expensive.

Open and closed hybrid cooling systems are special mechanical tower designs, which allows wet and dry operation to reduce visible plume formation. With the option of operating the systems (in particular small cell-type units) as dry systems during periods of low ambient air temperatures, a reduction in annual water consumption and visible plume formation can be achieved.

Table 1: Example of technical and thermodynamic characteristics of the different cooling systems for industrial (non-power plant) applications

Cooling system	Cooling medium	Main cooling principle	Minimum approaches (K) ⁴⁾	Minimum achievable end temperature of the process medium ⁵⁾ (°C)	Capacity of industrial process (MW _{th})
Open once-through system - direct	Water	Conduction/Convection	3 – 5	18 – 20	<0.01 - > 2000
Open once-through system - indirect	Water	Conduction/Convection	6 – 10	21 – 25	<0.01 - > 1000
Open recirculating cooling system - direct	Water ¹⁾ Air ²⁾	Evaporation ³⁾	6 – 10	27 – 31	< 0.1 - >2000
Open recirculating cooling system - indirect	Water ¹⁾ Air ²⁾	Evaporation ³⁾	9 – 15	30 – 36	< 0.1 - > 200
Closed circuit wet cooling system	Water ¹⁾ Air ²⁾	Evaporation + convection	7 – 14 ⁷⁾	28 – 35	0.2 – 10
Closed circuit dry air cooling system	Air	Convection	10 – 15	40 – 45	< 0.1 – 100
Open hybrid cooling	Water ¹⁾ Air ²⁾	Evaporation + convection	7 – 14	28 – 35	0.15 - 2.5 ⁶⁾
Closed hybrid cooling	Water ¹⁾ Air ²⁾	Evaporation + convection	7 – 14	28 – 35	0.15 - 2.5 ⁶⁾

Notes:

- 1) Water is the secondary cooling medium and is mostly recirculated. Evaporating water transfers the heat to the air
- 2) Air is the cooling medium in which the heat is transferred to the environment.
- 3) Evaporation is the main cooling principle. Heat is also transferred by conduction/convection but in a smaller ratio.
- 4) Approaches relative to wet or dry bulb temperatures
Approaches of heat exchanger and cooling tower must be added
- 5) End temperatures depend on the site's climate (data are valid for average middle European climate conditions
30°/21°C dry / wet bulb temperature and 15°C max. water temperature
- 6) Capacity of small units – with a combination of several units or specially built cooling, systems higher capacities can be achieved.
- 7) Where an indirect system applies or convection is also involved the approach in this example increases with 3-5K leading to an increased process temperature

The table shows the characteristics of the applied cooling systems for a given climatic situation. The end temperature of the process medium leaving the heat exchanger after cooling depends on the coolant temperature and on the design of the cooling system. Water has a higher specific heat capacity than air and therefore is the better coolant. The temperature of the coolant air and water depend on the local dry and wet bulb temperatures. The higher the bulb temperatures the more difficult it is to cool down to low end temperatures of the process.

The end temperature of the process is the sum of the lowest ambient (coolant) temperature and the minimum required temperature difference between coolant (entering the cooling system) and process medium (leaving the cooling system) over the heat exchanger, which is also called the (thermal) approach. Technically the approach can be very small by design, but costs are inversely proportional to the size. The smaller the approach the lower the process end temperature can be. Each heat exchanger will have its approach and, in the case of additional heat exchangers, in series, all approaches are added to the temperature of the coolant (entering the cooling system) to calculate the achievable end temperature of the process. Additional heat exchangers are used in indirect cooling systems, where an extra cooling circuit is applied. This secondary circuit and the primary cooling circuit are linked by a heat exchanger. Indirect cooling systems are applied where leakage of process substances into the environment must be strictly avoided.

For the cooling systems commonly applied in the power industry, minimum approaches and cooling capacities are somewhat different from non-power plant applications because of the special requirements of the steam condensation process. The different approaches and relevant power generating capacities are summarized below.

Table 2: Examples of capacity and thermodynamic characteristics of different cooling systems for applications in power industry

Cooling system	Applied approaches (K)	Capacity of power generating process (MW_{th})
Open once-through systems	13-20 (terminal difference 3-5)	< 2700
Open wet cooling tower	7-15	< 2700
Open hybrid cooling tower	15-20	< 2500
Dry air-cooled condenser	15-25	< 900

3. Environmental aspects of the applied cooling systems

The environmental aspects of cooling systems vary with the applied cooling configuration, but the focus is predominantly on increasing the overall energy efficiency and reduction of emissions to the aquatic environment. The consumption and emission levels are very site-specific and where it is possible to quantify them they show large variation. In the philosophy of an integrated BAT approach, cross-media effects must be taken into account in the assessment of each environmental aspect and the associated reduction measures.

- **Energy consumption**

The specific direct and indirect consumption of energy is an important environmental aspect relevant for all cooling systems. The specific indirect energy consumption is the energy consumption of the process to be cooled. This indirect energy consumption can increase due to a sub-optimal cooling performance of the applied cooling configuration, which may result in a temperature rise of the process (ΔK) and is expressed in $kW_e/MW_{th}/K$.

The specific direct energy consumption of a cooling system is expressed in kW_e/MW_{th} and refers to the amount of energy consumed by all energy consuming equipment (pumps, fans) of the cooling system for each MW_{th} it dissipates.

Measures to reduce the specific indirect energy consumption are:

- to select the cooling configuration with the lowest specific indirect energy consumption (in general once through systems),
- to apply a design with small approaches and
- to reduce the resistance to heat exchange by proper maintenance of the cooling system.

For example, in case of power industry a change from once through to recirculating cooling means an increase in energy consumption for auxiliaries, as well as a decrease of efficiency in the thermal cycle.

To reduce the specific direct energy consumption, pumps and fans with higher efficiencies are available. Resistance and pressure drops in the process can be reduced by design of the cooling system and by application of low resistance drift eliminators and tower fill. Proper mechanical or chemical cleaning of surfaces will maintain low resistance in the process during operation.

- **Water**

Water is important for wet cooling systems as the predominant coolant, but also as the receiving environment for cooling water discharge. Impingement and entrainment of fish and other aquatic organisms occur with large water intakes. Discharge of large amounts of warm water can also influence the aquatic environment, but the impact can be controlled by suitable location of intake and outfall and assessment of tidal or estuarine flows to insure adequate mixing and advective dispersion of the warm water.

Consumption of water varies between $0.5 \text{ m}^3/\text{h}/\text{MW}_{\text{th}}$ for an open hybrid tower and up to $86 \text{ m}^3/\text{h}/\text{MW}_{\text{th}}$ for an open once-through system. Reduction of large water intakes by once-through systems requires a change towards recirculating cooling at the same time it will reduce the discharge of large amounts of warm cooling water and may also reduce emissions of chemicals and waste. The water consumption of recirculating systems can be reduced by increasing the number of cycles, by improving the water make up quality or by optimizing the use of waste water sources available on or off site. Both options require a complex cooling water treatment programme. Hybrid cooling, which allows dry cooling during some periods of the year, with a lower cooling demand or with low air temperatures and so can reduce water consumption in particular for small cell-type units.

Design and positioning of the intake and various devices (screens, barriers, light, sound) are applied to reduce the entrainment and impingement of aquatic organisms. The effect of the devices depends on the species. Costs are high and measures are preferably applied in a greenfield situation. Lowering the required cooling capacity if possible by increasing the reuse of heat may reduce emissions of warm cooling water to the receiving surface water.

- **Emissions of heat into the surface water**

As mentioned before the emissions of heat into surface water can have environmental impact on the receiving surface water. Factors of influence are e.g. the available cooling capacity of the receiving surface water, the actual temperature and the ecological status of the surface water. Emissions of heat can result in the exceeding the EQS for temperature during warm summer periods as a consequence of heat discharges into the surface water resulting from cooling water. For two ecological systems (Salmonid waters and Cyprinid waters) thermal requirements have been taken up in Directive 78/659/EEC. Relevant for the environmental impact of heat emissions is not only the actual temperature in the water, but also the temperature rise at the boundary of the mixing zone as a consequence of the heat discharge into the water. The amount and level of the heat discharged into the surface water related to the dimensions of the receiving surface water are relevant to the extent of the environmental impact. In situations where heat discharges at relatively small surface waters and the hot water plume reaches the opposite side of the river or canal this can lead to barriers for the migration of Salmonides.

Besides these effects high temperature as a consequence of heat emissions can lead to increased respiration and biological production (eutrophication) resulting in a lower concentration of oxygen in the water.

When designing a cooling system the above aspects and the possibilities to reduce the heat dissipated into the surface water have to be taken into account.

- **Emissions of substances into surface water**

Emissions into the surface water from cooling systems caused by:

- applied cooling water additives and their reactants,
- airborne substances entering through a cooling tower,
- corrosion products caused by corrosion of the cooling systems' equipment, and
- leakage of process chemicals (product) and their reaction products.

Proper functioning of cooling systems may require the treatment of cooling water against corrosion of the equipment, scaling and micro- and macrofouling. Treatments are different for open once-through and recirculating cooling systems. For the latter systems, cooling water treatment programmes can be highly complex and the range of chemicals used can be large. As a consequence, emission levels in the blowdown of these systems also show large variation and representative emission levels are difficult to report. Sometimes the blowdown is treated before discharge.

Emissions of oxidizing biocides in open once-through systems, measured as free oxidant at the outlet, vary between 0.1 [mg FO/l] and 0.5 [mg FO/l] depending on the pattern and frequency of dosage.

Table 3: Chemical components of cooling water treatments used in open and recirculating wet cooling systems

Examples of chemical treatment*	Water quality problems					
	Corrosion		Scaling		(Bio-)fouling	
	Once-through systems	Recirculating systems	Once-through systems	Recirculating systems	Once-through systems	Recirculating systems
Zinc		X				
Molybdates		X				
Silicates		X				
Phosphonates		X		X		
Polyphosphonates		X		X		
Polyol esters				X		
Natural organics				X		
Polymers	(X)		(X)	X		
Non-oxidizing biocides						X
Oxidizing biocides					X	X

* chromate is not widely used anymore due to its high environmental effect

Selecting and applying cooling equipment that is constructed of material suitable for the environment in which it will operate can reduce leakage and corrosion. This environment is described by:

- the process conditions, such as temperature, pressure, flow speed,
- the media cooled, and
- the chemical characteristics of the cooling water.

Materials commonly used for heat exchangers, conduits, pumps and casing are carbon steel, copper-nickel and various qualities of stainless steel, but titanium (Ti) is increasingly used. Coatings and paints are also applied to protect the surface.

• Use of biocides

Open once-through systems are predominantly treated with oxidizing biocides against macrofouling. The amount applied can be expressed in the yearly used oxidative additive expressed as chlorine-equivalent per MW_{th} in connection with the level of fouling in or close to the heat exchanger. The use of halogens as oxidative additives in once-through systems will lead to environmental loads primarily by producing halogenated by-products.

In open recirculating systems, pretreatment of water is applied against scaling, corrosion and micro-fouling. With the relatively smaller volumes of recirculating wet systems alternative treatments are successfully applied, such as ozone and UV light, but they require specific process conditions and can be quite costly.

Operational measures reducing harmful effects of cooling water discharge are the closing of the purge during shock treatment and the treatment of the blowdown before discharge into the receiving surface water. For treatment of blowdown in a wastewater treatment facility the remaining biocidal activity must be monitored as it may affect the microbial population.

To reduce the emissions in the discharge and to reduce the impact on the aquatic environment, biocides are selected which aim to match the requirements of the cooling systems with the sensitivity of the receiving aquatic environment.

- **Emissions to air**

The discharged air from dry circuit cooling towers is usually not considered as the most important aspect of cooling. Contamination may occur if there is a leak of product, but proper maintenance can prevent this.

The droplets in the discharge of wet cooling towers can be contaminated with water treatment chemicals, with microbes or with corrosion products. The application of drift eliminators and an optimized water treatment programme reduce potential risks.

Plume formation is considered where the horizon-marring effect occurs or where risk exists of the plume reaching ground level.

- **Noise**

The emission of noise is a local issue for large natural draught cooling towers and all mechanical cooling systems. Unattenuated sound power levels vary between 70 for natural draught and about 120 [dB(A)] for mechanical towers. Variation is due to differences in equipment and to place of measurement as it differs between air inlet and air outlet. Fans, pumps and falling water are the major sources.

- **Risk aspects**

Risk aspects of cooling systems refer to leakage from heat exchangers, to storage of chemicals and to microbiological contamination (such as legionnaire's disease) of wet cooling systems.

Preventive maintenance and monitoring are applied measures to prevent leakage as well as microbiological contamination. Where leakage could lead to discharges of large amounts of substances harmful to the aquatic environment, indirect cooling systems or special preventive measures are considered.

For prevention of the development of *Legionellae pneumophila (Lp)* an adequate water treatment programme is advised. No upper concentration limits for *Lp*, measured in colony forming units [CFU per liter], could be established below which no risk is to be expected. This risk has to be particularly addressed during maintenance operations.

- **Residues from cooling systems operation**

Little has been reported on residues or wastes. Sludges from cooling water pretreatment or from the basin of cooling towers have to be regarded as waste. They are treated and disposed of

in different ways depending on the mechanical properties and chemical composition. Concentration levels vary with the cooling water treatment programme.

Environmental emissions are further reduced by applying less harmful conservation methods for equipment and by selecting material that can be recycled after decommissioning or replacement of cooling systems' equipment.

4. Key BAT conclusions

BAT or the primary BAT approach for new and existing systems are presented in Chapter 4. The findings can be summarised as follows.

It is acknowledged that the final BAT solution will be a site-specific solution, but for some issues techniques could be identified as general BAT. In all situations the available and applicable options for reuse of heat must have been examined and used to reduce the amount and level of non-recoverable heat, before the dissipation of heat from an industrial process into the environment is considered.

For all installations BAT is a technology, method or procedure and the result of an integrated approach to reduce the environmental impact of industrial cooling systems, maintaining the balance between both the direct and indirect impacts. Reduction measures should be considered maintaining at minimum the efficiency of the cooling system or with a loss of efficiency, which is negligible, compared with the positive effects on the environmental impact.

For a number of environmental aspects, techniques have been identified that can be considered BAT within the BAT approach. No clear BAT could be identified on the reduction of waste or on techniques to handle waste while avoiding environmental problems such as contamination of soil and water or, with incineration, of air.

- **Process and site requirements**

Selection between wet, dry and wet/dry cooling to meet process and site requirements should aim at the highest overall energy efficiency. To achieve a high overall energy efficiency when handling large amounts of low level heat (10-25°C) it is BAT to cool by open once-through systems. In a greenfield situation this may justify selection of a (coastal) site with reliable large amounts of cooling water available and with surface water with sufficient capacity to receive large amounts of discharged cooling water.

Where hazardous substances are cooled that (emitted via the cooling system) involve a high risk to the environment, it is BAT to apply indirect cooling systems using a secondary cooling circuit.

In principle, the use of groundwater for cooling has to be minimized, for instance where depletion of groundwater resources cannot be ruled out.

- **Reduction of direct energy consumption**

Low direct energy consumption by the cooling system is achieved by reducing resistance to water and/or air in the cooling system, by applying low energy equipment. Where the process to be cooled demands variable operation, modulation of air and water flow has been successfully applied and can be considered BAT.

- **Reduction of water consumption and reduction of heat emissions to water**

The reduction of water consumption and the reduction of heat emissions to water are closely linked and the same technological options apply.

The amount of water needed for cooling is linked to the amount of heat to be dissipated. The higher the level of reuse of cooling water, the lower the amounts of cooling water needed.

Recirculation of cooling water, using an open or closed recirculating wet system, is BAT where the availability of water is low or unreliable.

In recirculating systems an increase of the number of cycles can be BAT, but demands on cooling water treatment may be a limiting factor.

It is BAT to apply drift eliminators to reduce drift to less than 0.01% of the total recirculating flow.

- **Reduction of entrainment**

Many different techniques have been developed to prevent entrainment or to reduce the damage in case of entrainment. Success has been variable and site-specific. No clear BAT have been identified, but emphasis is put on an analysis of the biotope, as success and failure much depend on behavioural aspects of the species, and on proper design and positioning of the intake.

- **Reduction of emissions of chemical substances to water**

In line with the BAT approach, the application of the potential techniques to reduce emissions to the aquatic environment should be considered in the following order:

1. selection of cooling configuration with lower emission level to surface water,
2. use of more corrosion resistant material for cooling equipment,
3. prevention and reduction of leakage of process substances into the cooling circuit,
4. application of alternative (non-chemical) cooling water treatment,
5. selection of cooling water additives with the aim of reducing impact on the environment, and
6. optimized application (monitoring and dosage) of cooling water additives.

BAT is reducing the need for cooling water conditioning by reducing the occurrence of fouling and corrosion through proper design. In once-through systems, proper design is to avoid stagnant zones and turbulence and to maintain a minimum water velocity (0.8 [m/s] for heat exchangers, 1.5 [m/s] for condensers).

It is BAT to select material for once-through systems in a highly corrosive environment involving Ti or high quality stainless steel or other materials with similar performance, where a reducing environment would limit the use of Ti.

In recirculating systems, in addition to design measures, it is BAT to identify the applied cycles of concentration and the corrosiveness of the process substance to enable selection of material with adequate corrosion resistance.

It is BAT for cooling towers to apply suitable fill types under consideration of water quality (content of solids), expected fouling, temperatures and erosion resistance, and to select construction material which does not need chemical conservation.

The VCI concept applied by chemical industry aims at minimizing the risks for the aquatic environment in case of leakage of process substances. The concept links the level of environmental impact of a process substance with the required cooling configuration and monitoring requirements. With higher potential risks for the environment in case of leakage the

concept leads to improved anti-corrosiveness, indirect cooling design and an increasing level of monitoring of the cooling water.

- **Reduction of emissions by optimized cooling water treatment**

Optimization of the application of oxidizing biocides in once-through systems is based on timing and frequency of biocide dosing. It is considered BAT to reduce the input of biocides by targeted dosing in combination with monitoring of the behavior of macrofouling species (e.g. valve movement of mussels) and using the residence time of the cooling water in the system. For systems where different cooling streams are mixed in the outlet, pulse-alternating chlorination is BAT and can reduce even further free oxidant concentrations in the discharge. In general, discontinuous treatment of once-through systems is sufficient to prevent fouling. Depending on species and water temperature (above 10-12°C) continuous treatment at low levels may be necessary.

For seawater, BAT-levels of free residual oxidant (FRO) in the discharge, associated with these practices, vary with applied dosage regime (continuous and discontinuous) and dosage concentration level and with the cooling system configuration. They range from ≤ 0.1 [mg/l] to 0.5 [mg/l], with a value of 0.2 [mg/l] as 24h-average.

An important element in introducing a BAT-based approach to water treatment, in particular for recirculating systems using non-oxidizing biocides, is the making of informed decisions about what water treatment regime is applied, and how it should be controlled and monitored. Selection of an appropriate treatment regime is a complex exercise, which must take into account a number of local and site-specific factors, and relate these to the characteristics of the treatment additives themselves, and the quantities and combinations in which they are used.

In order to assist the process of BAT decision making on cooling water additives at a local level, the BREF seeks to provide the local authorities responsible for issuing an IPPC permit with an outline for an assessment.

The Biocidal Products Directive 98/8/EC regulates the placing of biocidal products on the European market and considers as a specific category the biocides used in cooling systems. The information exchange shows that in some Member States specific assessment regimes are in place for the application of cooling water additives.

The discussion as part of the information exchange on industrial cooling systems resulted in two proposed concepts for cooling water additives, which can be used as a complementary tool by the permitting authorities:

1. A screening assessment tool based on the existing concepts, which allows a simple relative comparison of cooling water additives in terms of their potential aquatic impact (the Benchmarking Assessment, Annex VIII.1).
2. A site specific assessment of the expected impact of biocides discharged in the receiving water, following the outcome of the Biocidal Products Directive and using the methodology to establish Environmental Quality Standards (EQSs) of the future Water Framework Directive as key elements (the Local Assessment for Biocides, Annex VIII.2).

The Benchmarking Assessment can be seen as a method to compare the environmental impact of several alternative cooling water additives while the Local Assessment for Biocides provides a yard stick for the determination of a BAT compatible approach for biocides in particular (PEC/PNEC <1). The use of local assessment methodologies as a tool in controlling industrial emissions is already common practice.

- **Reduction of emissions to air**

The reduction of the impact of emissions to air from cooling tower operation is linked to the optimization of cooling water conditioning to reduce concentrations in the droplets. Where drift is the main transporting mechanism, the application of drift eliminators, resulting in less than 0.01% of the recirculating flow being lost as drift, is considered BAT.

- **Reduction of noise**

Primary measures are applications of low noise equipment. The associated reduction levels are up to 5 [dB(A)].

Secondary measures at inlet and outlet of mechanical cooling towers have associated reduction levels of a minimum of 15 [dB(A)] or more. It must be noted that noise reduction, in particular by secondary measures, can lead to pressure drop, which needs extra energy input to compensate.

- **Reduction of leakage and microbiological risk**

BAT are: preventing leakage by design; by operating within the design limits and by regular inspection of the cooling system.

For the chemical industry in particular, it is considered BAT to apply the safety concept of VCI as has been mentioned before for reduction of emissions to water.

The occurrence in a cooling system of *Legionella pneumophila* cannot be fully prevented. It is considered BAT to apply the following measures:

- avoid stagnant zones and keep sufficient water velocity,
- optimize cooling water treatment to reduce fouling, algae and amoeba growth and proliferation,
- apply periodic cleaning of the cooling tower basin and
- reduce respiratory vulnerability of operators by supplying noise and mouth protection when entering an operating unit or when high-pressure cleaning the tower.

5. Distinction between new and existing systems

All key BAT conclusions can be applied to new systems. Where it involves technological changes, the application may be limited for existing cooling systems. For small cooling towers produced in series, a change in technology is considered to be technically and economically feasible. Technological changes for large systems are generally cost intensive requiring a complex technical and economic assessment involving a large number of factors. Relatively small adaptations to these large systems, changing part of the equipment, may be feasible in some cases. For more extensive changes of technology a detailed consideration and assessment of the environmental effect and the costs may be necessary.

In general, BAT for new and existing systems are similar, where the focus is on reducing environmental impact by improvement of the systems' operation. This refers to:

- optimization of cooling water treatment by controlled dosage and selection of cooling water additives aiming at reduction of the impact on the environment,
- regular maintenance of the equipment, and
- monitoring of operating parameters, such as the corrosion rate of the heat exchanger surface, chemistry of the cooling water and degree of fouling and leakage.

Examples of techniques considered BAT for existing cooling systems are:

- application of suitable fill to counteract fouling,
- replacement of rotating equipment by low noise devices,
- prevention of leakage by monitoring heat exchanger tubes,
- side stream biofiltration,
- improvement of the quality of the make up water, and
- targeted dosage in once-through systems.

6. Conclusions and recommendations for future work

This BREF has met a high level of support from the Technical Working Group (TWG). To assess and identify BAT for the process of industrial cooling is generally considered as complex and very site- and process-specific, involving many technical and cost aspects. Still, there is clear support for the concept of general BAT for cooling systems based on the general BREF-Preface and the introduction on BAT in Chapter 4.

The process of information exchange revealed a number of issues where further work is needed when this BREF is reviewed. The local assessment of cooling water treatment will require further investigation on how to take into account all relevant factors and chemical characteristics related to the site, but at the same time clear guidance and a workable procedure are necessary. Other fields of interest where additional efforts would be needed concern alternative cooling water treatment techniques, the minimization of microbiological risk and the relevance of emissions to air.

Draft Reference Document on the application of Best Available Techniques to Industrial Cooling Systems

Executive summary	i
Preface	1
Scope	5
Glossary	7
Thermodynamic definitions	7
Other definitions	8
Abbreviations and acronyms	13
1 General BAT concept for industrial cooling systems	15
1.1 Sources of heat, heat levels and application ranges	19
1.2 Level of cooling system and influence on process efficiency	20
1.2.1 Temperature sensitive applications	20
1.2.2 Non-sensitive applications	22
1.3 Optimising the primary process and reuse of heat	22
1.3.1 Optimising the primary process	22
1.3.2 Use of waste heat off-site	23
1.4 Selecting of a cooling system in order to meet the process requirements and site conditions	23
1.4.1 Process requirements	23
1.4.2 Site selection	25
1.4.3 Climatic conditions	28
1.4.4 Mathematical modelling, simulations on models and tests on pilot loops	30
1.5 Selecting a cooling technique in order to meet environmental requirements	30
1.5.1 General comparison between air and water cooled systems	30
1.5.2 Design factors and choice of materials	31
1.5.3 Options for a technological change of existing systems	32
1.5.3.1 Retrofit – reasons and considerations	33
1.5.3.2 Change of heat transfer technology	34
1.5.3.3 Replacement of outdated heat transfer technology by modern one	35
1.5.3.4 Upgrading existing heat transfer technology	36
1.5.4 Economic considerations	37
2 Technological aspects of applied cooling systems	39
2.1 Introduction	39
2.2 Heat exchangers	41
2.2.1 Shell and tube heat exchangers	41
2.2.2 Plate and frame heat exchangers	41
2.2.3 Environmental issues of heat exchangers	42
2.3 Once-through cooling systems	42
2.3.1 Direct once-through cooling systems	42
2.3.2 Once-through cooling systems with cooling tower	43
2.3.3 Indirect once-through cooling systems	44
2.4 Open recirculating cooling systems	45
2.4.1 Natural draught wet cooling towers	46
2.4.2 Mechanical draught wet cooling towers	48
2.4.2.1 Forced draught wet cooling towers	49
2.4.2.2 Induced draught wet cooling towers	50
2.5 Closed circuit cooling systems	51
2.5.1 Air-cooled cooling systems	51
2.5.1.1 Natural draught dry cooling tower	52
2.5.1.2 Air-cooled liquid cooling systems	54
2.5.1.3 Air-cooled steam condensers	55
2.5.2 Closed circuit wet cooling systems	56
2.5.2.1 Mechanical draught wet closed circuit cooling systems	57
2.5.2.2 Evaporative steam condensers	57
2.6 Combined wet/dry cooling systems	58
2.6.1 Open wet/dry (hybrid) cooling towers	58
2.6.2 Closed circuit hybrid cooling systems	59
2.6.2.1 Sprayed (finned) coils	60
2.6.2.2 Adiabatic coolers, wetting and pre-cooling the air that cools the coils	60
2.6.2.3 Combined technology	61

2.6.2.4	Costs of hybrid systems	61
2.7	Recirculating cooling systems	62
2.7.1	Direct recirculating cooling systems	62
2.7.2	Indirect recirculating cooling systems	62
2.8	Costs of cooling systems	62
3	Environmental aspects of industrial cooling systems and applied prevention and reduction techniques	65
3.1	Introduction	65
3.2	Consumption of energy	67
3.2.1	Direct consumption of energy	67
3.2.2	Indirect consumption of energy	67
3.2.3	Reduction of required energy for cooling	70
3.3	Consumption and emission of cooling water	71
3.3.1	Consumption of water	71
3.3.1.1	Intake of water and water requirements	71
3.3.1.2	Applied techniques to reduce water consumption	73
3.3.2	Fish entrainment	74
3.3.2.1	Level of entrainment	74
3.3.2.2	Applied reduction techniques	75
3.3.2.3	Costs of sound devices and light systems	77
3.3.3	Heat emission to surface water	77
3.3.3.1	Levels of heat emission	77
3.3.3.2	Legislative requirements of heat emissions	78
3.3.3.3	Applied reduction techniques	79
3.4	Emissions from cooling water treatment	80
3.4.1	Application of cooling water treatment	80
3.4.2	Emissions of chemicals into the surface water	83
3.4.2.1	Oxidising biocides	83
3.4.2.2	Non-oxidising biocides	84
3.4.2.3	Factors influencing emissions of biocides	84
3.4.2.4	Emission levels	85
3.4.2.5	Legislation	85
3.4.3	Reduction of emissions to the surface water	86
3.4.3.1	General approach	86
3.4.3.2	Reduction by selection of material and systems design	91
3.4.4	Reduction by application of additional and alternative cooling water treatment	91
3.4.5	Reduction of emissions by assessment and selection of cooling water additives	92
3.4.6	Optimising the use of cooling water additives	95
3.4.6.1	Dosage of cooling water additives	96
3.4.6.1.1	Dosage regimes	96
3.4.6.1.2	Dosage systems	97
3.4.6.2	Monitoring of cooling water	98
3.4.6.2.1	Monitoring of scale inhibitors, corrosion inhibitors and dispersants	98
3.4.6.2.2	Monitoring of biofouling	99
3.5	Cooling air use and air emissions	101
3.5.1	Air requirements	101
3.5.2	Direct and indirect emissions	101
3.5.3	Cooling tower plumes	103
3.5.3.1	Plume formation	103
3.5.3.2	Plume abatement	103
3.6	Noise emissions	104
3.6.1	Sources of noise and noise levels	104
3.6.2	Noise abatement	107
3.6.2.1	Noise control of cascading water (wet cooling towers)	107
3.6.2.1.1	Primary measures	107
3.6.2.1.2	Secondary measures	107
3.6.2.1.3	Dry-cooling towers	108
3.6.2.2	Noise control of mechanical equipment (mechanical draught cooling towers)	108
3.6.2.2.1	Primary measures	108
3.6.2.2.2	Secondary measures	109
3.6.2.3	Costs of noise reduction	109

3.7	Risk aspects associated with industrial cooling systems.....	110
3.7.1	Risk of leakage.....	110
3.7.1.1	Occurrence and consequences.....	110
3.7.1.2	Reduction of leakage.....	111
3.7.1.3	Reduction by preventive maintenance.....	112
3.7.2	Storage and handling of chemicals.....	113
3.7.3	Microbiological risk.....	113
3.7.3.1	Occurrence of microbes.....	113
3.7.3.2	Measuring of bacteriae.....	114
3.7.3.3	Techniques to reduce microbiological risks.....	114
3.8	Waste from cooling system operation.....	117
3.8.1	Formation of sludges.....	117
3.8.2	Residues from cooling water treatment and cleaning operations.....	117
3.8.3	Residues as a result of retrofitting, replacing and decommissioning of the installation.....	117
3.8.3.1	Use of plastics.....	118
3.8.3.2	Treatment of timber used for wet cooling tower construction.....	118
3.8.3.3	Wet cooling tower fill.....	118
4	Best available techniques for industrial cooling systems.....	119
4.1	Introduction.....	119
4.2	A horizontal approach to defining BAT for cooling systems.....	120
4.2.1	Integrated heat management.....	121
4.2.1.1	Industrial cooling = Heat management.....	121
4.2.1.2	Reduction of the level of heat discharge by optimization of internal/external heat reuse.....	121
4.2.1.3	Cooling system and process requirements.....	121
4.2.1.4	Cooling system and site requirements.....	123
4.2.2	Application of BAT in industrial cooling systems.....	124
4.3	Reduction of energy consumption.....	125
4.3.1	General.....	125
4.3.2	Identified reduction techniques within the BAT-approach.....	126
4.4	Reduction of water requirements.....	127
4.4.1	General.....	127
4.4.2	Identified reduction techniques within the BAT-approach.....	127
4.5	Reduction of entrainment of organisms.....	128
4.5.1	General.....	128
4.5.2	Identified reduction techniques within the BAT-approach.....	128
4.6	Reduction of emissions to water.....	128
4.6.1	General BAT approach to reduce heat emissions.....	128
4.6.2	General BAT approach to reduce chemical emissions to water.....	129
4.6.3	Identified reduction techniques within the BAT-approach.....	131
4.6.3.1	Prevention by design and maintenance.....	131
4.6.3.2	Control by optimised cooling water treatment.....	133
4.7	Reduction of emissions to air.....	134
4.7.1	General approach.....	134
4.7.2	Identified reduction techniques within the BAT-approach.....	135
4.8	Reduction of noise emissions.....	135
4.8.1	General.....	135
4.8.2	Identified reduction techniques within the BAT-approach.....	136
4.9	Reduction of risk of leakage.....	136
4.9.1	General approach.....	136
4.9.2	Identified reduction techniques within the BAT-approach.....	137
4.10	Reduction of biological risk.....	137
4.10.1	General approach.....	137
4.10.2	Identified reduction techniques within the BAT-approach.....	138
5	Concluding remarks.....	139
5.1	Timing of the work.....	139
5.2	Sources of information.....	139
5.3	Recommendations for future work.....	139
	References.....	141
	Annexes.....	149

List of tables

Table 1.1: Heat temperature levels and application range.....	20
Table 1.2: Emissions of an average Western European power plant due to an efficiency loss of 3%	21
Table 1.3: Relative effect on the delivery of electrical power due to the application of wet, wet/dry or dry cooling towers to units of 1300 MW _e	21
Table 1.4: Relative effect on the delivery of electrical power due to the application of wet, wet/dry or dry cooling towers to a 290 MW _{th} combined cycle unit.....	22
Table 1.5: Large cooling demand-related criteria for site selection.....	27
Table 1.6: Climatic conditions in Europe.....	29
Table 1.7: Comparison of different cooling systems with a required maximum sound power level	32
Table 1.8: Technological upgrading options for existing systems.....	34
Table 1.9: Example for conversion of a once-through system into a recirculating system.....	35
Table 1.10: Example for conversion of an outdated mechanical draught wet cooling tower into modern design	36
Table 1.11: Example for replacement of outdated fill of a mechanical draught wet cooling tower with modern high efficiency fill.....	36
Table 1.12: Example for the improvement of acoustic performance by addition of sound attenuation.....	37
Table 2.1: Example of technical and thermodynamic characteristics of the different cooling systems for industrial (non-power plant) applications.....	40
Table 2.2: Examples of capacity and thermodynamic characteristics of different cooling systems for applications in power industry.....	41
Table 2.3: Cost elements for water and air cooling systems	63
Table 3.1: Environmental issues of the different industrial cooling systems	66
Table 3.2: Example of a comparison of yearly specific direct and indirect energy demand of different cooling systems and the consequences for CO ₂ -emissions per MW _{th}	69
Table 3.3: Water requirement of the different cooling systems	72
Table 3.4: Fish impingement rates (FIR) at power stations. Annual catches normalised to the cooling water flow.....	75
Table 3.5: Available fish protection technologies for cooling water intake devices.....	76
Table 3.6: Thermal requirements of water temperatures for two ecological systems (European Directive 78/659/EEC).....	78
Table 3.7: Chemical components of cooling water treatments used in open and recirculating wet cooling systems	82
Table 3.8: Consumption of hypochlorite in wet cooling systems in The Netherlands.....	83
Table 3.9: Average required airflow for the different cooling systems.....	101
Table 3.10: Examples of capacity and associated unattenuated sound power levels of cooling systems equipment of a large refinery.....	106
Table 3.11: Comparison of unattenuated sound power levels at air inlet and air outlet measured at various types of wet cooling towers of conventional construction	106
Table 3.12: Noise emissions of different cooling systems without noise attenuation.....	106
Table 3.13: Example of cost increase with different fan design for reduced sound power level	109
Table 3.14: Effects of temperature and biocide treatment on CFU-levels in cooling towers.....	116
Table 4.1: Examples of process requirements and BAT	122
Table 4.2: Examples of site characteristics and BAT.....	123
Table 4.3: BAT for increasing overall energy efficiency.....	126
Table 4.4: BAT for reduction of water requirements.....	127
Table 4.5: BAT for reduction of entrainment.....	128
Table 4.6: BAT for reduction of emissions to water by design and maintenance techniques.....	131
Table 4.7: BAT for reduction of emissions to water by optimised cooling water treatment.....	133
Table 4.8: BAT for reduction of emissions to air.....	135
Table 4.9: BAT for the reduction of noise emissions.....	136
Table 4.10: BAT to reduce the risk of leakage.....	137
Table 4.11: BAT to reduce biological growth.....	138

List of figures

Figure 1.1: Breakdown structure showing the factors involved in the determination of BAT for waste heat discharge systems	17
Figure 1.2: Tower plan area as a function of the percentage of time the design wet bulb temperature is exceeded	24
Figure 2.1: Schematic representation of a direct once-through cooling system	42
Figure 2.2: Schematic representation of a direct once-through cooling system with a cooling tower applied in power industry.....	43
Figure 2.3: Schematic representation of an indirect once-through cooling system	44
Figure 2.4: Schematic representation of an open recirculating system.....	45
Figure 2.5: Natural draught wet cooling tower counter flow.....	47
Figure 2.6: Natural draught wet cooling tower cross flow.....	48
Figure 2.7: Fan assisted natural draught cooling tower	49
Figure 2.8: Schematic representation of a forced draught tower with counter flow design.....	50
Figure 2.9: Schematic presentation of a cell type induced draught cooling tower, cross flow design.....	51
Figure 2.10: Schematic presentation of principle of a dry natural draught cooling tower.....	53
Figure 2.11: Example of natural draught dry cooling tower for a power plant application	53
Figure 2.12: Schematic presentation of the principle of a dry air-cooled cooling system	54
Figure 2.13: Example of a dry air-cooled liquid cooler in a chemical process.....	54
Figure 2.14: Schematic presentation of the principle of a direct air-cooled condenser	55
Figure 2.15: Example of an air-cooled condenser for condensation of turbine exhaust steam.....	56
Figure 2.16: Schematic presentation of the principle of a closed recirculating wet cooling tower with induced draught.....	57
Figure 2.17: Schematic representation of hybrid cooling tower principle (example applied in power industry).....	58
Figure 2.18: Schematic presentation of the principle of a closed circuit hybrid cooling tower.....	60
Figure 2.19: Combined dry/wet operation of a hybrid cooling system.....	61
Figure 3.1: Graphic representation of interrelation between the different water quality problems	81
Figure 3.2: Design scheme for cooling water systems aiming at reduction of biocide application	87
Figure 3.3: “approach” for reduction of biocide use in industrial cooling water systems	88
Figure 3.4: Additive concentration pattern resulting of improperly designed monitoring and dosage regime	95
Figure 3.5: Additive concentration pattern resulting of properly designed monitoring and dosage regime	96

PREFACE

1. Status of this document

Unless otherwise stated, references to “the Directive” in this document means the Council Directive 96/61/EC on integrated pollution prevention and control. This document forms part of a series presenting the results of an exchange of information between EU Member States and industries concerned on best available techniques (BAT), associated monitoring, and development in them. It is published by the European Commission pursuant to Article 16(2) of the Directive, and must therefore be taken into account in accordance with Annex IV of the Directive when determining “best available techniques”.

2. Relevant legal obligations of the IPPC Directive and the definition of BAT

In order to help the reader understand the legal context in which this document has been drafted, some of the most relevant provisions of the IPPC Directive, including the definition of the term “best available techniques”, are described in this preface. This description is inevitably incomplete and is given for information only. It has no legal value and does not in any way alter or prejudice the actual provisions of the Directive.

The purpose of the Directive is to achieve integrated prevention and control of pollution arising from the activities listed in its Annex I, leading to a high level of protection of the environment as a whole. The legal basis of the Directive relates to environmental protection. Its implementation should also take account of other Community objectives such as the competitiveness of the Community’s industry thereby contributing to sustainable development.

More specifically, it provides for a permitting system for certain categories of industrial installations requiring both operators and regulators to take an integrated, overall look at the polluting and consuming potential of the installation. The overall aim of such an integrated approach must be to improve the management and control of industrial processes so as to ensure a high level of protection for the environment as a whole. Central to this approach is the general principle given in Article 3 that operators should take all appropriate preventative measures against pollution, in particular through the application of best available techniques enabling them to improve their environmental performance.

The term “best available techniques” is defined in Article 2(11) of the Directive as “the most effective and advanced stage in the development of activities and their methods of operation which indicate the practical suitability of particular techniques for providing in principle the basis for emission limit values designed to prevent and, where that is not practicable, generally to reduce emissions and the impact on the environment as a whole.” Article 2(11) goes on to clarify further this definition as follows:

“techniques” includes both the technology used and the way in which the installation is designed, built, maintained, operated and decommissioned;

“available” techniques are those developed on a scale which allows implementation in the relevant industrial sector, under economically and technically viable conditions, taking into consideration the costs and advantages, whether or not the techniques are used or produced inside the Member State in question, as long as they are reasonably accessible to the operator;

“best” means most effective in achieving a high general level of protection of the environment as a whole.

Furthermore, Annex IV of the Directive contains a list of “considerations to be taken into account generally or in specific cases when determining best available techniques ... bearing in mind the likely costs and benefits of a measure and the principles of precaution and prevention”. These considerations include the information published by the Commission pursuant to Article 16(2).

Competent authorities responsible for issuing permits are required to take account of the general principles set out in Article 3 when determining the conditions of the permit. These conditions must include emission limit values, supplemented or replaced where appropriate by equivalent parameters or technical measures. According to Article 9(4) of the Directive, these emission limit values, equivalent parameters and technical measures must, without prejudice to compliance with environmental quality standards, be based on the best available techniques, without prescribing the use of any technique or specific technology, but taking into account the technical characteristics of the installation concerned, its geographical location and the local environmental conditions. In all circumstances, the conditions of the permit must include provisions on the minimisation of long-distance or transboundary pollution and must ensure a high level of protection for the environment as a whole.

Member States have the obligation, according to Article 11 of the Directive, to ensure that competent authorities follow or are informed of developments in best available techniques.

3. Objective of this Document

Article 16(2) of the Directive requires the Commission to organise “an exchange of information between Member States and the industries concerned on best available techniques, associated monitoring and developments in them”, and to publish the results of the exchange.

The purpose of the information exchange is given in recital 25 of the Directive, which states that “the development and exchange of information at Community level about best available techniques will help to redress the technological imbalances in the Community, will promote the world-wide dissemination of limit values and techniques used in the Community and will help the Member States in the efficient implementation of this Directive.”

The Commission (Environment DG) established an information exchange forum (IEF) to assist the work under Article 16(2) and a number of technical working groups have been established under the umbrella of the IEF. Both IEF and the technical working groups include representation from Member States and industry as required in Article 16(2).

The aim of this series of documents is to reflect accurately the exchange of information which has taken place as required by Article 16(2) and to provide reference information for the permitting authority to take into account when determining permit conditions. By providing relevant information concerning best available techniques, these documents should act as valuable tools to drive environmental performance.

4. Information Sources

This document represents a summary of information collected from a number of sources, including in particular the expertise of the groups established to assist the Commission in its work, and verified by the Commission services. All contributions are gratefully acknowledged.

5. How to understand and use this document

The information provided in this document is intended to be used as an input to the determination of BAT in specific cases. When determining BAT and setting BAT-based permit conditions, account should always be taken of the overall goal to achieve a high level of protection for the environment as a whole.

The rest of this section describes the type of information that is provided in each section of the document.

Chapter 1 provides information on the issue of cooling industrial processes and on the horizontal approach taken to present BAT applied to industrial cooling systems.

Chapter 2 describes the cooling systems and their configurations commonly used by industry. In this chapter some associated performance data are presented as well as an overview of the relevant environmental issues.

Chapter 3 describes more extensively the environmental issues with reference to the emission reduction and other techniques that are considered to be most relevant for determining BAT both generally and as a basis for setting permit conditions. As far as applicable, this information includes the consumption and emission levels considered achievable that relate to the cooling systems applied. Techniques that are generally seen as obsolete are not included.

Chapter 4 concludes on general BAT within the primary BAT-approach acknowledging that BAT for cooling systems finally is a site-specific solution.

Chapter 5 gives a general conclusion on the result of the information exchange process with respect to industrial cooling systems and describes elements for future work.

In twelve annexes additional information is given on thermodynamics, energy, operating factors, as well as information on techniques and practices to be considered in the application of BAT when operating an industrial cooling system.

The purpose is thus to provide general indications regarding the emission and consumption levels that can be considered as an appropriate reference point to assist in the determination of BAT-based permit conditions or for the establishment of general binding rules under Article 9(8). It should be stressed, however, that this document does not propose emission limit values. The determination of appropriate permit conditions will involve taking account of local, site-specific factors such as the technical characteristics of the installation concerned, its geographical location and the local environmental conditions. In the case of existing installations, the economic and technical viability of upgrading them also needs to be taken into account. Even the single objective of ensuring a high level of protection for the environment as a whole will often involve making trade-off judgements between different types of environmental impact, and these judgements will often be influenced by local considerations.

Although an attempt is made to address some of these issues, it is not possible for them to be considered fully in this document. The techniques and levels presented in chapters 3 and 4 will therefore not necessarily be appropriate for all installations. On the other hand, the obligation to ensure a high level of environmental protection including the minimisation of long-distance or transboundary pollution implies that permit-conditions cannot be set on the basis of purely local considerations. It is therefore of the utmost importance that the information contained in this document is fully taken into account by permitting authorities.

Since the best available techniques change over time, this document will be reviewed and updated as appropriate. All comments and suggestions should be made to the European IPPC Bureau at the Institute for Prospective Technological Studies at the following address:

Edificio Expo-WTC; Inca Garcilaso s/n, E-41092 Seville – Spain
Telephone: +34 95 4488 284 Fax: +34 95 4488 426
e-mail eippcb@jrc.es
Internet: <http://eippcb.jrc.es>

SCOPE

This reference document on BAT for industrial cooling systems is a horizontal document that focuses on the cooling systems commonly used within the industrial activities of Annex 1 to the IPPC Directive. The industry sectors with high relevance are the chemicals, food, glass, iron and steel, refineries, pulp and paper and the incinerators. In the power industry, an incomparable amount of information and experience has been gained with respect to cooling. Also, the power industry relatively has the largest direct and indirect impacts on the environment with sub-optimal cooling. In a separate annex, special attention is paid to this sector and any disparities between power stations and other industrial activities have been assessed. Although installations for the production of nuclear power are not part of the scope of Annex I of the IPPC Directive, the applied environmental techniques are considered in this document where they relate to the cooling systems of the conventional section of these installations. Cooling systems of small combustion plants and air conditioning systems for both industrial and domestic use are excluded.

The scope of the term “cooling systems” in this reference document is confined to systems to remove waste heat from any medium, using heat exchange with water and/or air to bring down the temperature of that medium towards ambient levels. This includes only part of refrigeration systems, but excludes the issue of refrigerants such as ammonia and CFCs. Also, direct contact cooling and barometric condensers are not assessed as they are considered to be too process-specific. The following industrial cooling systems or configurations are covered in this document:

- Once-through cooling systems (with or without cooling tower)
- Open recirculating cooling systems (wet cooling towers)
- Closed circuit cooling systems
 - air-cooled cooling systems
 - closed circuit wet cooling systems
- Combined wet/dry (hybrid) cooling systems
 - open hybrid cooling towers
 - closed circuit hybrid tower

In this document, BAT is described for cooling systems that are considered to work as auxiliary systems for the normal operation of an industrial process. It is acknowledged that reliable operation of a cooling system will positively affect the reliability of the industrial process. However, the function of a cooling system in relation to process safety is not within the scope of this BREF.

Within the horizontal “approach”, integration means addressing all relevant environmental aspects and the way in which they are interrelated, whilst acknowledging that balancing the various aspects requires expert judgement. Where appropriate, the relevance of the environmental performance of a cooling system within the performance of the entire industrial process is indicated.

The document addresses the following environmental aspects and the methods and techniques for reduction of emissions:

- effects of process and equipment design, and of material and maintenance;
- resource consumption (water, air, energy, chemical substances);
- emissions of chemicals and heat both to water and air,
- emissions of noise and plumes;
- waste generation and emissions to soil and terrestrial habitats;
- risk aspects;
- pollution arising from specific events (starts/stops) or incidents and
- decommissioning of installations.

Scope

This document will give a review of available techniques for industrial cooling systems, but will not give solutions on what the best cooling system is and does not intend to disqualify any of the existing systems applied. Nor will it give guidelines on whether a process needs a cooling system at all. This means that the document will not go into the detail of the production processes themselves that require cooling, where overall energy efficiency measures would be addressed. A general “approach” is followed, which leads to a balanced choice of a new system or of measures to optimise an existing cooling system aiming at prevention of environmental emissions related to the operation of cooling systems.

Glossary

Terminology used for the different aspects of industrial cooling systems varies widely and various terms are often used for the same element. To avoid confusion and to avoid explanatory repetition in this document this section gives a number of definitions of terms and abbreviations.

Thermodynamic definitions

Approach	<p>(1) in a conduction heat exchanger device, the temperature difference between the temperature of the process medium leaving the heat exchanger and the temperature of the cooling medium entering the heat exchanger.</p> <p>(2) in an evaporative system (e.g. wet cooling tower), the difference between the temperature of the process medium leaving the cooling system and the wet bulb temperature of the air entering the cooling tower or the evaporative cooling system.</p> <p>(3) in a condenser see terminal difference.</p>
Design Dry Bulb Temperature	the temperature of the ambient air for which the heat exchanger is designed. Usually 95 % values are used – the design temperature will not be exceeded in 95 % of time. <i>Dry bulb temperature</i> is the relevant temperature for <i>sensible heat transfer</i> .
Design Wet Bulb Temperature	the lowest temperature, to which air can be cooled down by adiabatic evaporation. It is the relevant temperature for <i>latent heat transfer</i> . <i>Design wet bulb temperature</i> is the temperature of saturated air, which will be used for the design of the evaporative waste heat exchanger. Usually 95 % values are used – the design temperature will not be exceeded in 95 % of time. Wet bulb temperature is always <i>below</i> dry bulb temperature.
Heat Rejection Capacity	the amount of heat, which can be rejected by a cooling system measured in kW_{th} (or MW_{th}).
Latent Heat Transfer	Heat transfer through the evaporation of water into the air. The heat transfer capacity of evaporating water is much higher than the heat transfer capacity of air.
Level of Waste Heat	the temperature level at which the heat has to be transferred. Depending on the process, the waste heat is generated at a specific temperature level.
LMTD	Logarithmic mean temperature difference is a measure of the driving force of the heat exchange depending on the temperature of the cold stream (coolant) and of the process stream to be cooled.

Range	<i>Range</i> is the difference between the inlet and the outlet temperature at a heat exchanger.
Sensible Heat Transfer	Heat transfer through conduction and convection is called <i>sensible heat transfer</i> .
Terminal difference	is the temperature difference in a condenser. It corresponds to the temperature difference between the temperature of the steam entering the condenser (or steam condensed leaving the condenser) and the temperature of the cooling medium (water) leaving the condenser. The values of “terminal difference” vary between 3 and 5 K.
Waste Heat	<i>Waste heat</i> is the inherent, yet unwanted, not recuperative heat, that must be removed from industrial or manufacturing processes and has to be transferred to the environment.

Other definitions

BAT approach	methodology presented in this document to arrive at a definition of BAT for industrial cooling systems and to identify techniques within this definition
Bioconcentration factor	the capacity of a substance to bioaccumulate defined as the ration between the concentration of a substance in an organism and its concentration in the water (in a state of equilibrium). The bioconcentration is always determined by experiment.
Blow down (BD, kg/s)	the intentional draining of a cooling system to balance the increasing concentration of solids in the cooling system and in practice it is the water that has to be withdrawn from an evaporative cooling system in order to control the cycle of concentration. It is calculated as $BD = E \cdot 1 / (x - 1)$, where E is the evaporation loss and x is the concentration factor. Calculating the blowdown usually includes the non-evaporative losses such as windage, drift and leakage.
Biocide	chemical that kills or slows down the growth of undesirable organisms. In cooling water systems a biocide kills or slows down the growth of macro- and micro-fouling organisms, thereby minimising organic pollution in the cooling system. The most important biocides are: chlorine, sodium hypochlorite, ozone, quaternary ammonium and organic bromide.
Biocide demand	the quantity of biocide that is reduced or converted to inert or less active forms of the biocide by substances in the water or the quantity of biocide that give complete reaction with all biocide-reactable materials.

Biochemical oxygen demand (BOD) (also named Biological oxygen demand)	a measure of the oxygen required to break down organic materials in water. Higher organic loads require larger amounts of oxygen and may reduce the amount of oxygen available for fish and aquatic life below acceptable levels. It can be assessed using a standard 5-day (BOD ₅) or 7-day (BOD ₇) test.
Bio-slime	or bio-slime is defined as the bacterial film that develops on any substrate immersed in water. It consists of algae and sessile microbial population, comprising slime producing bacteria and anaerobic sulphate reducing bacteria. Microfouling promotes the deposition of macrofouling.
Breakpoint	the demand of oxidizing biocide by water impurities which must be overcome before a viable biocide-concentration in the cooling water is available.
Chemical oxygen demand (COD)	a measure of the oxygen-consuming capacity of inorganic and organic matter present in water or waste (discharged cooling) water; the amount of oxygen consumed from a chemical oxidant in a specific test. (normally referring to analysis with dichromate oxidation)
Coatings	materials applied to surfaces to form either a low friction surface to reduce pump losses, or a protective layer to reduce erosion, corrosion and fouling.
Concentration factor (CR)	concentration factor or cycles of concentration is the ratio of concentration of any particular solute in the recirculating cooling water to that in the makeup water. Calculated as $CR = MU/BD$, where MU is the make up water and BD the blow down.
Condenser	cooler used for condensation of a gas flow (or steam). Condensation places extra demands on the heat exchanger: there must be space for the vapour volume. Condensers of power stations are therefore extremely large and specifically designed.
Coolant	synonym for cooling medium. In many cases the coolant is water or air, but can also be water mixed with an antifreeze substance or a medium such as oil or a gas.
Corrosion	can be defined as the destruction of a metal by (electro-) chemical reaction with its environment.
Corrosion inhibitors	are chemical substances that are able to slow down the corrosion process in water. They are de-aeration substances, passivating inhibitors (eg chromate, nitrite, molybdate, and orthophosphate), precipitating inhibitors (zinc phosphate, calcium carbonate and calcium orthophosphate), and adsorption inhibitors

	(glycine derivatives, aliphatic sulfonates and sodium silicate).
Counter flow	is the principle where the air flows in the opposite direction within the heat exchanger. In counter flow towers air moves upward opposed to the downward flow of the cooling water. This design provides good heat exchange because the coolest air contacts the coolest water. Headers and spray nozzles are used to distribute the water.
Cross flow	is the principle where air flows perpendicular to the process fluid within the heat exchanger. In cross flow towers air flows horizontally across the downward stream of the cooling water.
Cycles of concentration	(or “cycles”) are a comparison of the dissolved solids level of the blowdown with that of the makeup water. Thus, it is defined as quotient of salt concentration in the blow-down and the salt concentration in the make-up.
Dispersion substances	or dispersants are chemicals that prevent the growth and deposit of particles present in water by increasing the electric charge resulting from absorption. As a result the particles repel each other and remain suspended.
Drift eliminators	devices that change the direction of airflow, imparting centrifugal force to separate water droplets from the air.
Drift loss	the loss of water due to small droplets, which are emitted into the draught air, leaving the top of a cooling tower.
Evaporative loss (E, kg/s)	the mass of cooling water, which is evaporated per time unit during the operation of an evaporative cooling-system.
Free oxidant (FO)/ Total residual oxidants (TRO)	applied measure of free oxidants in the discharge of cooling water systems. Also referred to as TRO or total chlorine (TC) or free chlorine (FC).
Free available chlorine (FAC) or free residual chlorine	free chlorine represents an equilibrium mixture of hypochlorous acid and hypochlorite ion OCl^- in the cooling water system. Both are oxidants, but OCl^- is far less effective than HOCl .
Hardness stabilisers	are chemical substances, which, added to water, are able to prevent the deposit of hardness salts by hindering the crystallisation process through absorption of the nucleation nuclei of the crystals. In this way the growth of amorphous crystals, which are relatively easy to keep in suspension and give less cause to deposits, is encouraged.

Hazardous substances	substances or groups of substances, that have one or several dangerous properties, such as toxic, persistent, bioaccumulative, or are classified as dangerous for the human or environment according to the Directive 67/548 (Dangerous substances directive).
Macrofouling	undesirable organisms in cooling water circuits, which are visible with the naked eye. Macrofouling is represented mainly by mussels, barnacles, and serpulid polychaetes that encrust the walls of the circuits with their calcareous walls, filamentous organisms such as hydroids, and other organisms such as sponges, bryozoans, and tunucates.
Make up (M, kg/s)	is defined as all water mass per time unit, which is added to the system to compensate the loss of water due to evaporation and blow down.
Maximum allowable risk-level	the concentration of a substance in surface water where 95% of the species are protected. The toxicity and degradability are important aspects.
Mechanical draught tower	cooling towers equipped with fans to push cooling air through the tower (forced draught) or to pull cooling air through the tower (induced draught).
Micro-fouling	or bio-slime is defined as the bacterial film that develops on any substrate immersed in water. It consists of algae and sessile microbial population, comprising slime producing bacteria and anaerobic sulphate reducing bacteria. Microfouling promotes the deposition of macrofouling.
Natural draught tower	large size cooling towers without fans, but designed to take advantage of the density difference between air entering the tower and the warmer air inside the tower to create a flow of cooling air.
Non-oxidising biocides	mostly organic substances used for cooling water treatment particularly in recirculating cooling systems. Their working is more specific than that of oxidising biocides oxidising some species more effectively than others. They exert their effects on micro-organisms by reaction with specific cell components or reaction pathways in the cell.
Oxidising biocides	mostly inorganic substances particularly applied in open once-through systems against fouling. They attack organisms via a non-specific mechanism. The biocide oxidises the cell wall or enters the cell and oxidises the cell components. These biocides are fast working and because of their non-specificity have a broader spectrum than the non-oxidising biocides.

Plume	is the visible re-condensation of evaporated water in the discharged air of a cooling tower.
Precipitation softening	this process is used to reduce water-hardness, alkalinity, silica, and other constituents. The water is treated with lime or a combination of lime and soda ash (carbonate ion). Water with moderate to high hardness (150-500 ppm as CaCO ₃) is often treated in this fashion.
Process medium	the <i>process medium</i> will always refer to the medium to be cooled.
Scaling	process of precipitation in CWS that occurs when the concentration of salts in the water film near the heat exchanger exceeds the solubility.
Sound Pressure Level (L_p)	the measure for the <u>immission</u> of sound – the amount of sound at a defined direction and distance from the sound source. It is measured in dB per frequency band or A weighted as dB(A). The measure is logarithmic, this means that doubling the sound pressure level is equal to an increase 6 dB(A).
Sound Power Level (L_w)	the measure for the amount of sound-energy, which is <u>radiated</u> (emitted) from a sound source. It measured in dB per frequency band or A weighted as dB(A). The measure is logarithmic, which means that doubling the sound power level is equal to an increase of 3 dB(A).
Hydraulic half time	is defined as the time needed to reduce the initial concentration of a non-degradable compound to 50% of its initial concentration.
Total available chlorine (TAC)/ total residual chlorine (TRC)	the sum of free chlorine and combined chlorine, with combined chlorine as the available chlorine in chloramines or other compounds having a N-C link, in cooling water system.
Total residual oxidants (TRO)	oxidant capacity measured in cooling water system via stoichiometric method (iodide.iodine). TRO is numerical and operational equivalent to TRC and TAC.
Variable speed drive	a way of controlling the speed of a motor, usually electronically using an inverter. The speed can be varied manually, but is more often controlled via a signal from the process, e.g. pressure, flow, level, etc.

Abbreviations and acronyms

Abbrev./acronym	Explanations	Pagenumber
ACC	Air-cooled condenser	304
AOX	Adsorbable organic halogens (X = Cl, Br)	98
ATP	Adenosine triphosphate	103
BAT	Best available technique	1
BCDMH	Bromo-chloro-dimethyl hydantoin	212
BCF	Bioconcentration factor	245
BNPD	Broomnitropropaandiol	130
BNS	β -brom- β -nitrostyrene	98
BOD	Biochemical oxygen demand (also named Biological oxygen demand)	23
BPM	Best practical means	108
BREF	BAT reference document	5
BTM	Best technical means	108
CCA	Copper sulphate, potassium dichromate, arsenic pentoxide	132
CFU	Colony forming units	154
COD	Chemical oxygen demand	23
CWS	Cooling water system	26
DBNPA	Dibromo-nitrilopropionamide	95
DPD	N-N-diethyl-p-phenylenediamine	103
EDF	Electricité de France	36
EIPPCB	European Integrated Pollution Prevention and Control Bureau	3
EOX	Extractable organic halogens (X= Cl, Br)	278
EQS	Environmental quality standard	10
EUR or €	Unit of european currency	48
FAC	Free available chlorine	24
FO	Free oxidant	11
FRO	Free residual oxidant	15
IEF	Information exchange forum	2
€ or EUR	European currency unit	10
kW _{th} or kW _e	1000 Watt (thermal or electric)	9
LD	Legionnaire's disease	128
<i>Lp</i>	<i>Legionella pneumophila</i>	128
mg/l	Milligram per litre	15
MBT	Methylene(bis)thiocyanate	98
MIC	Microbiologically influenced corrosion	205
Mt or Mt	Metric tonne	188
MW _{th} or MW _e	1000000 Watt (thermal or electric)	8
mwg	Metre water gorge	82
<i>Nf</i>	<i>Naegleria fowleri</i>	128
NOEC	No observed effect level	82
PEC	Predicted environmental concentration	15
PHMB	Polyhexamethylenebiguanidechloride (QAC)	130
PNEC	Predicted no effect concentration	15
P _{ow}	Partition coefficient over the phases n-octanol and water	108
ppm	Parts per million	26
RIZA	Dutch water management institute for inland water management and waste water treatment	155
QAC	Quarternary Ammonium Compounds	130
QSARs	Quantitative structure activity relationship	245
TBTO	Tributyltinoxide	105
TDS	Total dissolved solids	263
TEMA	Tubular Exchange Manufacturers Association	194
THM	Trihalomethanes	211
TOC	Total organic carbon	221

Glossary

TRO	Total residual oxidant	24
TWG	Technical working group	17
UV	Ultra violet (light)	95
VCI	Association of chemical industry in Germany	14
VDI	Association of German Engineers (Verein Deutscher Ingenieure)	118
VFD	Variable frequency drive	290
WFD	Water Framework Directive (to be adopted)	144

1 GENERAL BAT CONCEPT FOR INDUSTRIAL COOLING SYSTEMS

In numerous industrial processes, heat has to be removed by what is called a waste heat removal system or cooling system. Operating these cooling systems has certain environmental consequences. The level and character of the environmental impact varies depending on the cooling principle and the way these systems are operated. To minimise this impact an “approach” can be followed which aims at prevention of emissions by proper design and selection of techniques.

Within the framework of IPPC, cooling should be considered as an integrated part of the overall energy management of an industrial process. The intention should be to reuse superfluous heat of one process in other parts of the same process or in different processes on site in order to minimise the need for discharge of waste heat into the environment. This will affect the overall energy efficiency of a process and reduce the demand for cooling, for the required capacity of the system and for its operational demands. The optimisation of energy efficiency, however, is a complex exercise and regarded as highly process-specific and as such beyond the scope of this horizontal document. If there are no options for reuse on-site, this does not have to lead automatically to discharge of heat into the environment, but options for reuse off-site in industrial or civil applications may be considered. In the end, if options for reuse of heat cannot be exploited any further, discharge of superfluous heat into the environment is to be considered.

Once the level of heat to be removed has been assessed, a first selection of the appropriate system for cooling can be decided upon. Much of the environmental performance due to the operation of a cooling system can be influenced by proper design and by selection of the right material taking into account the process requirements and local aspects. It is reported that 80% of cooling system performance has already been determined at the design table and 20% by the way the cooling system is operated (so-called 80/20 rule). Many different factors need balancing in assessing what is BAT (best available techniques) for the reduction of the environmental impact of cooling. Right from the start it is important to realise that a cooling system is an auxiliary, but generally crucial and integrated system for an industrial process and that every change applied to the process of cooling may potentially affect the performance of the industrial or manufacturing process to be cooled.

Therefore, the integrated assessment of the consumption and emissions of cooling systems and the decision on the application of a cooling technique both should be made in the light of the total environmental performance of the plant and within the requirements of the process to be cooled, ultimately balanced with costs. The required level of cooling must be guaranteed, with minimal consequences for the environment. The required level of cooling is process-specific. Where some processes can tolerate a certain temporary rise in process temperature, other more temperature sensitive processes might not, as this will have a large impact on the environmental performance of the whole plant.

According to IPPC, the environmental performance of the cooling systems discussed in this BREF must be improved by applying BAT. The question is if and how BAT for cooling systems can be determined in a general sense, where the final determination on what is best is certainly a local matter answering the specific requirements of process, environment and economics. To structure and in some way simplify the complex process of determination of BAT, this document follows the “approach” described above and presented in Figure 1.1. This “approach” should lead to a balanced decision on the application of a system for cooling and on its optimisation based on BAT for both new and existing situations.

The BAT concept consists of the following steps aiming at reduction of emissions and minimisation of the environmental impact:

- reduce the final level of waste heat produced, considering options for reuse;
- define process requirements;
- consider general site conditions;
- assess environmental requirements:
 - options for minimisation of resource consumption
 - options for reduction of emissions
- develop system operation (maintenance, monitoring and risk prevention)
- apply economic requirements

In Figure 1.1, the BAT “approach” is presented in a schematic way showing the most relevant factors involved in the determination of BAT for industrial cooling systems. For the sake of clarity not all links that can possibly be made between different aspects of cooling have been added in this scheme. For example, there is a link between sound attenuation measures and the reduction of specific direct energy consumption; and the achievable minimum end temperature of a cooling system is limited by the local climatic conditions.

In the following sections the BAT ”approach” will be further discussed in the light of common principles of operating industrial cooling systems and, where possible, indicating what the application of BAT means in the spirit of the IPPC-Directive. By its nature, this optimisation cannot be an exact mathematical comparison of various solutions. The optimisation process includes a similar challenge for all environmental balances, as it requires a comparison of different environmental impacts and a decision about which ones are the least severe or most acceptable. Nevertheless, the suggested BAT “approach” aims at providing significant information on the implications of various solutions for the environment, on costs and risks as well as the influencing factors. Based on this information, a decision can be made which is much more justified than just concentrating on optimising one single factor (e.g. water intake, energy consumption, plume or noise emission etc.).

Examples will be given to indicate the direction of the changes, rather than to specify particular emissions or reductions. Where appropriate, data are shown or reference is made to the annexes, but for most of the factors involved, data on resource use and on emissions of cooling systems are either limited or they are too specific to be generally applicable.

Summarising, the assessment of a cooling system, balancing the different factors, is founded on the following points:

- the requirements of the process to be cooled take precedence over the measures for reduction of the environmental impact of a cooling system;
- applying the BAT “approach” is not aiming at a disqualification of any of the configurations described in Chapter 2;
- the BAT “approach” has more freedom for optimisation and prevention of emissions in the design phase in case of new installations, but for existing installations design options should also be considered;
- consequently, for existing plants it is expected that the BAT “approach” will start further down in the consecutive assessment steps;
- a further distinction can be made between large custom-made cooling systems and smaller systems (series product) with respect to the level of environmental impact;
- optimisation should be seen as the application of design options, of reduction techniques and of good operator practice;
- the level of reduction of emissions resulting from the BAT “approach” is not predictable, but depends on the demands placed on the cooling system;
- the BAT “approach” aims at cooling system operation balancing the requirements by the process to be cooled and by the local environmental objectives;
- selection schemes are useful in making a balanced choice and
- finally each balanced result will have a certain environmental impact.

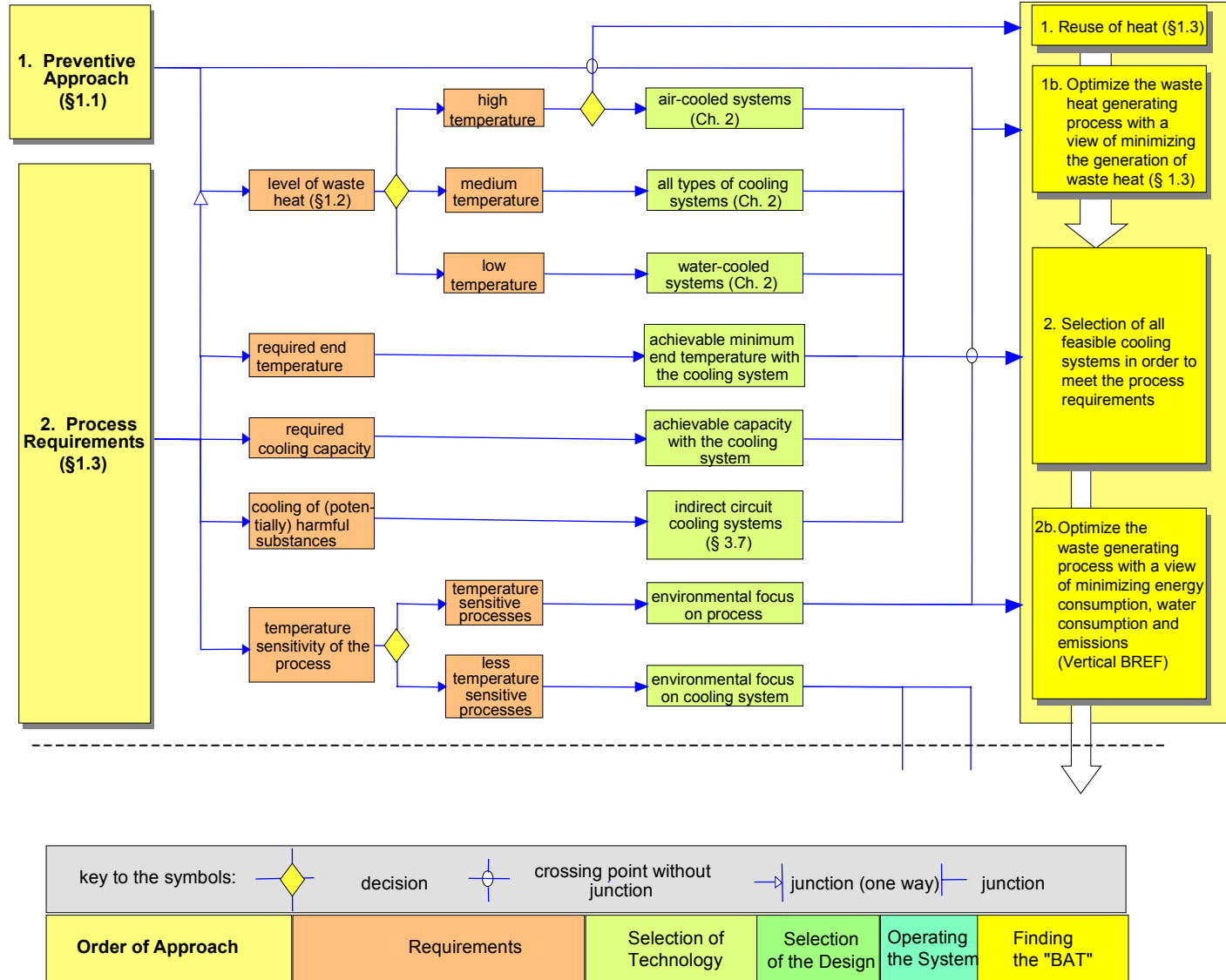

Figure 1.1: Breakdown structure showing the factors involved in the determination of BAT for waste heat discharge systems [tm134, Eurovent, 1998]

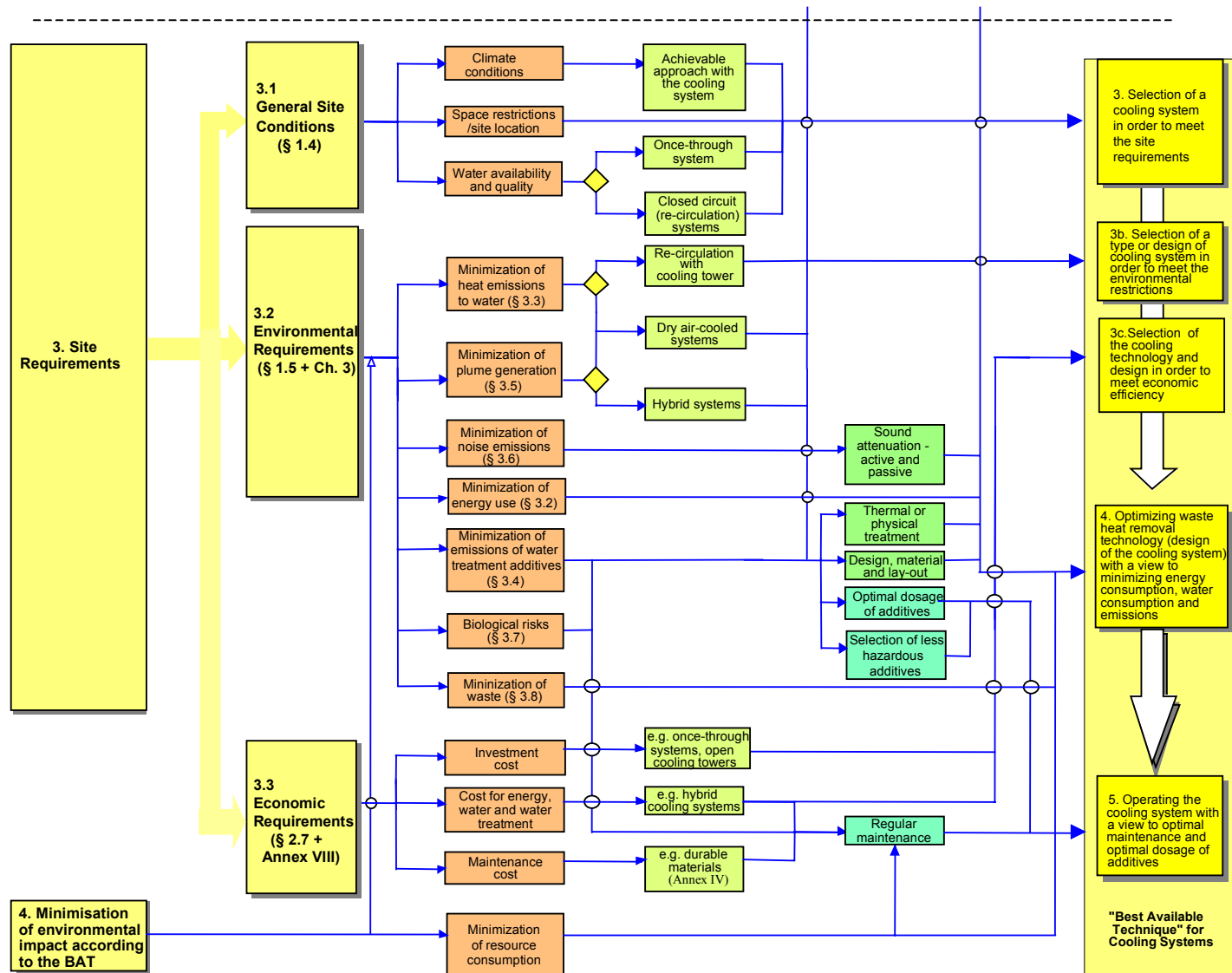

Figure 1.1: (continued): Breakdown structure showing the factors involved in the determination of BAT for waste heat discharge systems [tm134, Eurovent, 1998]

1.1 Sources of heat, heat levels and application ranges

All industrial and manufacturing processes which use energy transform different forms of energy (mechanical, chemical, electrical etc.) into heat and noise. Depending on the process, this heat cannot always be fully recovered and/or re-used, but has to be removed from the process by cooling. The amount of non-recoverable heat can be called waste heat, and it needs to be transferred to the environment, as this serves as a heat sink. A number of processes with a specifically high production of waste heat and a high demand for cooling are mentioned below. In many processes different sources of waste heat exist and at different levels: high (above 60 °C), medium (25-60°C), and low (10-25°C). Also, different processes with their specific demand can be found within the same production site. Large cooling systems are used for large combustion plants (power industry), in the chemical industry, refineries, the iron and steel industry, the food industry, the pulp and integrated paper industry, incinerators and in the glass industry.

Within a similar process cooling is applied for different purposes such as cooling of process substances in a heat exchanger, of pumps and compressors, of vacuum systems and of steam turbine condensers. The following major sources of waste heat can be distinguished with their related levels of waste heat.

- Friction - by definition the transformation of mechanical energy into heat. Cooling systems for these processes are usually indirect systems with oil as a primary coolant. Because oil is used as a cooling medium, the cooling system is sensitive to high temperatures. Therefore, the average temperature of the waste heat is at medium level.
- Combustion - the transformation of chemical energy by oxidation into heat. The waste heat level of combustion processes is variable.
- Exothermic Processes (chemical) - Many chemical processes are exothermic: chemical energy is transformed into heat without any combustion. Exothermic processes are often very sensitive to the efficiency of the removal of waste heat. The temperature level of the waste heat is medium to high, depending on the process.
- Compression - compressing a gas leads to the generation of heat. This heat usually has to be removed as waste heat at a medium to high temperature level.
- Condensation (thermodynamic cycles) - Many processes work on the principles of thermodynamic cycles. A liquid medium is evaporated, taking up energy, and is consequently condensed, transforming rejected energy as heat. Thermodynamic systems are very sensitive to temperature and the temperature level is medium to low.

The waste heat level is an important factor to be taken into account when selecting an industrial cooling system. Table 1.1 shows the temperature ranges of the medium to be cooled and the most suitable cooling systems. The lower the waste heat level, the more difficult it is to cool with dry air-cooled systems. In practice, air-cooling is often used for process temperatures above about 60°C. Heat levels above 100°C are generally pre-cooled with air-coolers if no options for reuse are available. Evaporative cooling is, in principle, often used to cool process flows with medium and low temperatures. For low temperatures also once-through systems are used, especially where large capacities are needed.

The ranges should not be taken as fixed when selecting a cooling system. For the high temperature range 50°C as well as the above-mentioned 60°C is being used. Also, temperatures depend largely on the local situation (climate and temperature of the coolant) and the potential application of a system will vary accordingly. So, once-through systems are also applied at higher temperature levels, provided that admissible discharge temperatures at the outlet into the receiving water will not be exceeded. For processes to be operated throughout the year under varying climatic conditions it can also be necessary to use a combination of different cooling systems.

Table 1.1: Heat temperature levels and application range
[tm139, Eurovent, 1998]

Temperature range	Suitable Cooling System	Typical Applications
Low temperature (10 – 25 °C)	<ul style="list-style-type: none"> once-through systems (direct/indirect) wet cooling towers (mechanical/natural draught) hybrid cooling towers combined cooling systems 	<ul style="list-style-type: none"> power generation (petro-) chemical processes
Medium temperature (25 – 60 °C)	<ul style="list-style-type: none"> once-through systems (direct/indirect) wet cooling towers (mechanical/natural draught) closed circuit cooling towers evaporative condensers air-cooled fluid coolers air-cooled condensers hybrid cooling towers/ condensers hybrid closed circuit cooling tower 	<ul style="list-style-type: none"> refrigeration cycles compressor cooling of machines autoclave cooling cooling of rotary kilns steel plants cement plants power generation in warmer regions (Mediterranean)
High Temperature (above 60 °C)	<ul style="list-style-type: none"> once-through systems (direct/indirect) in special cases wet cooling towers (mechanical/natural draught) air-cooled fluid cooler/ condensers 	<ul style="list-style-type: none"> waste incineration plants engine cooling cooling of exhaust fumes chemical processes

1.2 Level of cooling system and influence on process efficiency

1.2.1 Temperature sensitive applications

Many chemical and industrial processes are temperature critical applications. The efficiency of the process is sensitive to temperature and/or pressure and therefore correlated with the efficiency of the removal of waste heat. For these processes, the horizontal “approach” of best available cooling technology is connected with the vertical “approach” of best available process technology. Examples for temperature critical applications are:

- power generation,
- thermodynamic cycles,
- exothermic processes.

Integrated pollution prevention means that selection of best available cooling technology and application of techniques, of treatments or ways of operating should consider not only the direct environmental impacts of the different cooling systems, but also the indirect environmental impacts due to varying efficiencies of the different processes. It has to be decided at local level whether should be pursued by focussing on the cooling system rather than on the production process. The increase of the indirect impacts can be considerably higher than the decrease of direct impacts of the selected cooling system.

Power plants (see Annex XII) are the most important source of waste heat. The transformation of fossil energy into electrical energy is connected with many of the waste heat generating processes mentioned in Section 1.1. Waste heat is generated during combustion, friction of the turbine, condensation of the steam and transformation of the electricity. A separate cooling water system, for the auxiliary systems using oil or gas for smooth operation of equipment, also generates a small amount of waste heat. If the cooling requirement of the power generating system cannot be met, it immediately shows in a decrease of the overall efficiency and in an increase of air emissions.

This correlation is illustrated by the following example for a power plant, in which an alternative, presumably less effective, cooling system leads to a loss in efficiency of the power plant of about 3% (Table 1.2). As a result the resource input of the power plant and its emissions to air will also increase with about 3%. As the emissions also depend on the fuel used, they could easily be different in another situation, but no data were available to evaluate this point further.

Table 1.2: Emissions of an average Western European power plant due to an efficiency loss of 3% [tm139, Eurovent, 1998]

Emissions to air	Emissions / energy input in [g/kWh]	Additional emission due to a loss of 3% efficiency [g/kWh]
CO ₂	485	14.6
SO ₂	2.4	0.072
NO _x	1.0	0.031
Dust	0.2	0.006
Primary energy input: 2.65 kW and additional energy input 0.08 kW		

How the selection of a cooling system can affect the performance is well illustrated by the following examples taken from Caudron [tm056, Caudron, 1991]. These figures highlight the effects of the selection of a cooling system under the given climate conditions. So care must be taken, as the loss of efficiency that can occur depends on the choice of the cooling system, the climatic conditions and the design of the turbine. Condenser vacuums (condenser pressures) will vary accordingly as illustrated in the following tables. In areas where higher ambient temperatures occur, the vacuum levels are higher with dry systems and can reach up to 425 mbar. But many other factors, such as fouling, scaling, corrosion and sub-optimal design, may lead to similar losses of efficiency.

Table 1.3: Relative effect on the delivery of electrical power due to the application of wet, wet/dry or dry cooling towers to units of 1300 MW_e. [tm056, Caudron, 1991]

Type of refrigeration system			Wet cooling tower		Wet/dry cooling tower	Dry cooling tower	
	Once-through	Wet natural draught	Natural draught	Induced draught	Induced draught	Natural draught	Induced draught
Approach K (dry air 11[°C] / wet air 9[°C])	-	12	12.5	12.5	13.5	16	17
Nominal condensation pressure (mbar)	44	68	63	63	66	82	80
Thermal power (MW _{th})	1810	1823	2458	-	-	-	-
Electrical power Delivered (MWe)	955	937	1285	1275	1275	1260	1240
Difference of electrical power delivered (%)	+ 1.9	0	0	- 0.8	- 0.8	- 2	- 3.5

In the table the once-through system is taken as starting point to benchmark the other systems. The approaches of the recirculating cooling systems are additional to the approach of the heat exchanger (condenser) which is assumed to be equal for all systems.

From this table it is clear that the choice of cooling system, such as for a dry instead of a wet system, needs careful consideration. The table also shows why many power plants are located preferably on the coast or on large rivers. From the production point of view, once-through systems are more efficient than the reference system (wet natural draught).

For combined cycles, the condenser pressure and electrical power delivered vary similarly with the type of the cooling system and the relative loss of power becomes even more clear.

Table 1.4: Relative effect on the delivery of electrical power due to the application of wet, wet/dry or dry cooling towers to a 290 MW_{th} combined cycle unit [EDF, pers. comm., 1999]

Type of cooling system	Wet cooling tower			Air-cooled condenser
	Once-through	Natural draught	Induced draught	
Approach K (dry air 11[°C]/wet air 9[°C])	/	≈8	≈8	≈29
Nominal condensation pressure (mbar)	34	44	44	74
Thermal power (MW _{th})	290	290	290	290
Difference of electrical power delivered (MW_e)	+ 0.65	0	-1.05	-5.65

1.2.2 Non-sensitive applications

Other applications are less sensitive to temperature. The efficiency of these processes is less correlated with temperature or pressure. For these processes the focus should be on the economically and ecologically most efficient cooling system to dissipate waste heat that remains after all the possible options for reuse have been exploited.

1.3 Optimising the primary process and reuse of heat

Optimisation of the overall energy efficiency of the primary process will not be dealt with in depth in this reference document. However, in the preventive “approach” of IPPC this optimisation should be done first before removal of waste heat is contemplated. In other words, the need for heat discharge has to be minimised, which will simultaneously affect the configuration and size of the required cooling system. Furthermore, the cooling system does not necessarily mean discharge into the environment, as successful attempts have been made to use this energy as well.

1.3.1 Optimising the primary process

The optimisation of the primary process can significantly reduce the overall environmental effects. In many Member States the majority of the non-recoverable heat to be disposed of by cooling systems is due to power generation. Depending on the overall efficiency, up to 60 % of the fuel energy is transferred into waste heat. If the efficiency of the power generating process is increased, environmental effects can be reduced and the cooling system plays a crucial role here. For other industrial sectors this principle can be applied as well, at the same time lowering the energy costs, the amount of heat discharged to the environment, as well as the emissions to air (CO₂). Generally, the higher the heat level the more easily it can be recovered.

A few examples of currently applied techniques are:

- preheating fuel or raw materials (metals);
- pinch-technology;
- external applications (e.g. heating greenhouses/ residential areas);
- co-generation in power industry.

Instead of using cooling water or air only, it is customary at refineries to preheat fuels by using a cold incoming hydrocarbon stream to cool down a hot refined stream leaving the unit. Consequently, there is a reduced need to preheat the (cold) crude fuel and a lower demand for cooling water. Depending on the process the number of cold streams can be limited and a certain need for cooling water or air will remain.

Co-generation, or combined heat and power generation, is used in the power industry and in other industrial sectors (e.g. paper industry, (petro-) chemical industry). Where both forms of energy are needed, their generation can be combined. This saves energy, reduces CO₂ and SO₂ emissions and requires hardly any cooling, thereby avoiding the need for (large) cooling systems.

1.3.2 Use of waste heat off-site

If optimising the waste heat generating process does not lead to any further waste heat reduction, the BAT “approach” would be to assess, whether any option of reuse of waste heat can be found. This issue is beyond the scope of IPPC as it also relates to generic good environmental energy management. It can be done on an existing site as well as an integral part of site selection (see next chapter). Finding adequate consumers is, however, not a trivial task. Often requirements of consumers are not reconcilable with the cooling demands. In some cases, heat consumers require a higher temperature level than planned. If it is technically possible to operate the primary process on a higher temperature level, the overall energy balance has to be carefully observed. Often the loss of energy efficiency in the primary process outweighs the savings through the “waste“ energy consumption. Also, care should be taken in creating a situation, in which there develops a dependency on the availability of “waste” heat.

A number of examples can be found of the external application of “waste” heat of power stations for district heating of homes and offices during winter periods or heating of greenhouses by applying co-generation or operating a combined cycle. The applications can raise fuel utilisation efficiency from around 40% up to more than 70% and thus decrease the cooling demand of the installation. In the examples reported, a hybrid cooling tower with variable fan speed is used to be able to adapt to the varying need for district heating. In another case the tower only needed to be operated in dry mode at about 10% of its total capacity as soon as outdoor air temperature had dropped to 5°C, simply because maximum external use of heat was reached at that point. This raises the question of the extent to which the potential options for reuse can influence the choice of a cooling system where flexibility of operation is required. Currently no examples are known that show how the options for reuse are reflected in the selection of a cooling system.

1.4 Selecting of a cooling system in order to meet the process requirements and site conditions

1.4.1 Process requirements

Once the level of heat (high, medium, and low) has been assessed, a first rough selection could be done by applying Table 1.1. In addition to the heat level, many more factors are also

involved in the selection of a cooling system in order to meet the process requirements and general site conditions, such as:

- the required minimum end temperature of the substance to be cooled,;
- the required cooling capacity;
- the requirement for an indirect circuit, which increases the approach;
- climatic conditions, water availability and space requirements.

In view of the indirect effects of sub-optimal process cooling, the required minimum end temperature of the process to be cooled is crucial. This means that the cooling system(s) used or to be chosen will have to achieve this end temperature and at the same time meet other (process-related) requirements. Cooling system performance should preferably be optimised, taking into account the annual temperature range of the coolant. For wet cooling, the wet bulb temperature is important and there is some flexibility to select a design temperature, which in its turn will affect the size of the cooling system and its power requirements. Reduction of the size of cooling systems has to be carefully evaluated and accepted only case by case. Some plants have to be operated the whole year round with acceptable efficiencies and maximum rated output. For example, when mechanical draught towers or dry air coolers are used, it is possible to operate the system in the most economical way if coolers have several cells. Some of them can be taken out of operation in order to save water and electric energy without an appreciable loss of efficiency.

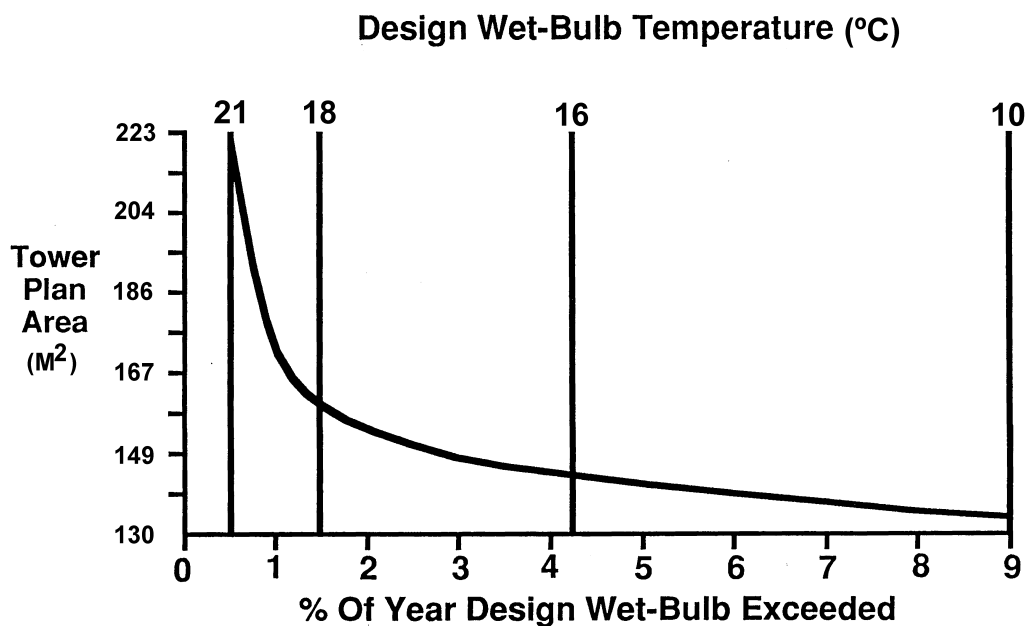

Figure 1.2: Tower plan area as a function of the percentage of time the design wet bulb temperature is exceeded (design temperatures 40/24/18°C), [tm083, Adams and Stevens]

With respect to the power industry, Figure 1.2 is not applicable as optimisation of the cold end is done using validated temperatures:

- for wet or dry cooling towers the wet (or dry) air temperature is taken for all year around, using one value for every 3 hours;
- for once-through the water temperature is measured and one value per month is recommended.

Then, optimisation is done taking into account the valorisation of energy for the whole year. This method, called global actualised balance, is explained in Annex XII.

Generally, in most industries a safety margin is applied to ensure that the cooling system will meet the cooling demand at any time and especially in the summer months. In circumstances where the wet bulb temperature at all times remains well below the design wet bulb temperature or where the heat load appears to be lower, the heat exchanger may have overcapacity. If this is expected, consideration could be given to operational measures, such as variable fan operation, that allow the system to run below capacity and thereby reduce the direct energy demand.

In many industries, it is practice to oversize the cooling system at the installation stage to leave room for capacity growth: the spare capacity is then gradually used up until a new tower needs to be added. When a licence application for expanding production and cooling capacity is being considered, an assessment must always be made of the extent to which there is spare capacity in the existing cooling system, whether inefficiently used (because it is underused) or not well maintained.

This strategy makes it possible to determine the required cooling capacity (kW_{th} or MW_{th}), the size of the cooling system (heat exchanger) and perhaps even the choice of coolant (water or air). In Europe the industries that require large cooling capacities for low process temperatures (power stations and (petro-) chemical industry) have a preference for sites, where large and reliable source of water is available and where the use of once-through systems is possible. Where the water supply is limited large capacity open wet or wet/dry cooling towers are used.

The need to cool (potentially) harmful substances can also affect the size of the cooling system as well as the possible end temperature (See e.g. VCI-safety concept in Chapter 3 and Annex VI). In this situation the BAT "approach" can lead to the conclusion that the effects of leakage can only be adequately prevented if a secondary (indirect) system is applied. This means that a second circulation has to be designed and the design temperature will increase, following an increase of the approach. This will lead to higher end temperatures of the substance to be cooled and further reduction in the overall efficiency.

1.4.2 Site selection

It is obvious that there is a limit to the extent in which site-specific characteristics can be optimised by choosing the optimal site. For existing systems the site simply is a given value and environmental optimisation will have to be considered within the restrictions of the site. For instance, restricting water use by changing to dry air-cooling might seem to be an obvious choice. However, climate conditions may not allow this where dry bulb temperature is expected to exceed the required design temperature for a large part of the year unless a reduced output of the production process is accepted as well as a simultaneous reduction in the overall efficiency of the plant.

If site selection is an option, the requirements of the cooling process can be influenced significantly. Therefore it is important that during the design phase all the following aspects are considered in the site selection process:

- quantity, quality and costs of cooling medium available (water as well as air),
- available size (area, height, weight of cooling installations),
- effect on the quality of water and on aquatic organisms,
- effect on the quality of air,
- meteorological effects,
- discharges of chemical substances into water,
- noise emissions,
- aesthetic aspects of the building,

- capital expenditure for cooling systems, pumps, piping and water treatment,
- operating costs for pumps, fans and water treatment,
- annual costs for maintenance and repair,
- operating parameters such as minimum service life, annual operating time, average load in thermal output and water flow rate,
- operating requirements such as required approach and systems availability,
- environmental legislative requirements regarding heat emissions, plume emissions, acoustic emissions, overall height etc.
- for power plants: plant efficiency losses, capital expenditure to compensate power output losses, plant lifetime and energy revenue losses due to lower plant efficiency.

Space

Different cooling systems need different amounts of space for the same cooling performance and vary in area requirements, height and weight. It depends on the heat transfer principle they follow (See Annex I).

For large systems, space restrictions can be an issue and will be part of the site assessment. The applies to processes to be cooled entirely by air where large multi-cell constructions are needed to ensure the required cooling capacity. For smaller capacities, space restrictions should not be a limiting factor as roof constructions are on the market that are specifically designed for these situations.

Restrictions on space at existing sites, for instance in densely built urban areas or densely built industrial sites, are an important factor in the selection of cooling systems. For example, a cooling tower on top of a building needs no additional ground space, but the roof location may impose restrictions on its weight.

Space and height requirements are important criteria for air-cooled and hybrid systems. The ventilation of air can be achieved by natural draught or by ventilation with fans (mechanical draught). For the same cooling capacity natural draught cooling systems have to be far bigger and higher than mechanical draught systems.

Site assessment

Regarding site selection in a number of Member States, it is common practice that for a large site an environmental impact assessment will be required as part of the permitting procedure. Also, due to the potential high impact of site selection on the cooling performance, there have been initiatives to pre-select optimum cooling sites in regional planning programmes.

An example of the assessment of a site for cooling systems with a large water requirement such as those used by power plants, is given in Table 1.5 [tm012, UBA, 1982]. A combination of local criteria leads towards the classification of a site with its suitability being most, intermediate or least favourable. It should be remarked that using such an assessment is again only part of the total assessment and that a grade 3 site (doubtful suitability) could well be favourable on the overall balance of factors.

An example of the consequences of site selection can be seen when the BAT “approach” is used for a site qualified as grade 3.

Table 1.5: Large cooling demand-related criteria for site selection
(Derived from [tm012, UBA, 1982])

Criteria	Grade 1 (good suitability)	Grade 2 (satisfactory suitability)	Grade 3 (doubtful suitability)	Explanations
Sufficient cooling water supply	$W > \frac{NNQ}{\zeta c \Delta T}$ Plentiful cooling water supply	$W \approx \frac{NNQ}{\zeta c \Delta T}$ Sufficient cooling water supply	$W < \frac{NNQ}{\zeta c \Delta T}$ Insufficient cooling water supply without technical measures	NNQ: lowest known volume flow of surface water W: heat stream to be transferred into water ζ : density of the water c: specific heat capacity of water ΔT : permitted temperature increase of surface water
Suitable water quality	Water quality class II moderately polluted II/III critically polluted	Water quality class III severely contaminated	Irrespective of quality class	(German water quality classification) I non-polluted II moderately polluted II/III critically polluted III-IV very severely contaminated IV excessively contaminated
Complying with permitted evaporation losses	$V < A a$ Minor evaporation losses	$V \approx A a$ Bearable evaporation losses	$V > A a$ Evaporation losses not acceptable without technical measures	V: evaporation losses at selected site (volume flow) A: permitted evaporation for the site a: fraction of A which may be used limited by other waste heat sources of the site
Impact on drinking water supply	Cooling water discharge has no impact on drinking water supply	Cooling water discharge may under certain circumstances impact drinking water supply, negative effects can be avoided	Cooling water discharge impacts drinking water supply, negative effects cannot be ruled out without additional technical measures	This criterion has to be considered if, downstream of the site, drinking water is obtained from the surface water (currently or planned in future)
Frequency of long plumes with low altitude and waste heat transfer in direct site vicinity (radius 2 km)	Very low frequency (<2% p.a. on average) long (<100 m) plumes with low altitude (≤ 300 m) and waste heat transfer < 10 000 MW	Long plumes with low altitude more frequent and waste heat transfer < 10 000 MW	Waste heat transfer > 10 000 MW	
Topographic situation in the vicinity of the site	No or only few elevations with an altitude higher than the cooling tower within about 20 km radius of the site	Several elevations higher than above the cooling tower within about 2 -20 km radius of the site	Several elevations higher than the cooling tower within less than 2 km radius of the site	
Possibility of economic use of waste heat	Great potential for economically feasible usage of district heating	Little potential for economically feasible usage of district heating	No possibility of economic waste heat usage or doubtful because not thoroughly investigated	The possibility for economic usage of waste heat increases attractiveness of a site and may overcome other disadvantages and lower the heat discharge

The assessment should start with a selection of options for reuse of heat, as this could have an effect on the cooling water demand. This criterion cannot be met as no external heat use is possible and all non-recoverable heat will have to be discharged. Water supply and permitted evaporation are limited and in respect of plumes there may be disturbance in the vicinity of the site. If for process reasons a water-cooled system is necessary, water saving methods will have to be applied and, for example, a recirculating system (e.g. open wet cooling tower) instead of a once-through system would be recommended. This will imply the application of some kind of water treatment, depending on water quality and cycles of concentration. The additional requirement would be plume suppression, which prompts consideration of a hybrid configuration. If enough space is available and climatic conditions favourable, the use of air-cooling may equally be considered. The integrated “approach” would follow with a comparison of energy use and costs. The site selection process requires that for the “final candidate” site, detailed considerations about the selection of the possible cooling systems be conducted in order to find the overall optimum solution.

1.4.3 Climatic conditions

The climate expressed in terms of wet and dry bulb temperatures is an extremely important site-specific condition. It influences both the choices of the type of cooling and the possible end temperature of the process to be cooled. The contradiction of cooling with air and/or water is that when the cooling demand is high it becomes more difficult to achieve the requirements. Particularly in areas where high air temperatures and high water temperatures coincide with lower water availability during part of the year a certain operational flexibility of the cooling system can be very important and may be achieved by combining water and air cooling. Sometimes, however, a certain loss of efficiency may have to be accepted.

To reach the required process temperature it is an obvious requirement of all cooling systems that the cooling medium must have a lower temperature than the medium to be cooled, but this depends on the dry and wet bulb temperatures. For both water and air-cooled systems, seasonal variations in the temperature of the cooling medium can be limit the choice of cooling system and can demand a certain way of operation.

Wet bulb temperature is always lower than dry bulb temperature (Table 1.6). The wet bulb temperature depends on the measured temperature of the atmosphere, the humidity and the air pressure. For latent (evaporative) heat transfer the wet bulb temperature is the relevant temperature. It is theoretically the lowest temperature to which water can be cooled by evaporation. For sensible heat transfer the dry bulb (dry air) temperature is relevant, where air is the coolant.

For the selection of the type and design of cooling system, the design temperature is important and usually relates to the summer levels of the wet bulb and dry bulb temperatures. The bigger the difference between these temperatures and the higher the dry bulb temperatures, the more difficult it will be to reach low end temperatures with dry air-cooled systems. As mentioned earlier, this can lead to efficiency losses. Measures can be taken to overcome the loss, but they require a certain investment. For economic reasons it is useful to determine the variation of these temperatures throughout the year and what percentage of the year the maximum temperatures are actually reached.

As an example, Table 1.6 shows how for different climate conditions in Europe the choice for a dry or a wet cooling system can affect process efficiency losses due to the Carnot cycle. In the example, the approach for wet cooling is considered to be 4 K and this has to be added to the wet bulb temperature to get the minimum end temperature of the coolant. The approach for dry cooling is set at 12 K to be added to the dry bulb temperature. The larger the difference between the wet and the dry end temperatures, the higher the loss of efficiency (in this example), where losses of 0.35% per K on average occur. At the same time, with for example 5% efficiency loss, the efficiency of a conventional power plant would be 38.6% instead of 40% (See Annex XII.6).

Table 1.6: Climatic conditions in Europe
(derived from [tm139, Eurovent, 1998])

Country and station								
		Dry-bulb temp. (1%) ² (°C)	Wet-bulb temp (1%) ² (°C)	Difference K	End temp. Dry system ³ (°C)	End temp. Wet system ⁴ (°C)	ΔT wet-dry (K)	Efficiency loss ⁵ (%)
Greece	Athens	36	22	14	48	26	22	7.7
Spain	Madrid	34	22	12	46	26	20	7.0
France	Paris	32	21	11	44	25	19	6.7
Italy	Rome	34	23	11	46	27	19	6.7
Austria	Vienna	31	22	9	43	26	17	6.0
Germany	Berlin	29	20	9	41	24	17	6.0
Netherlands	Amsterdam	26	18	8	38	22	16	5.6
France	Nice	31	23	8	43	27	16	5.6
UK	London	28	20	8	40	24	16	5.6
Germany	Hamburg	27	20	7	39	24	15	5.3
Norway	Oslo	26	19	7	38	23	15	5.3
Belgium	Brussels	28	21	7	40	25	15	5.3
Spain	Barcelona	31	24	7	43	28	15	5.3
Finland	Helsinki	25	19	6	37	23	14	4.9
Denmark	Copenhagen	26	20	6	38	24	14	4.9
Portugal	Lisbon	32	27	5	44	31	13	4.6
UK	Glasgow	23	18	5	35	22	13	4.6
Ireland	Dublin	23	18	5	35	22	13	4.6

Notes:

- 1) the given data in Table 1.4 are illustrative of the variation of the climate in Europe. Other references may provide slightly different data. The exact data or a site can be analysed by a meteorological institute.
- 2) statistically only 1% of the maximum temperatures are above this data
- 3) approach 12 K
- 4) approach for wet system: 4 K
- 5) loss of efficiency 0.35% per ΔT K on average

1.4.4 Mathematical modelling, simulations on models and tests on pilot loops

For the assessment of the impact of new and existing large cooling systems and for optimising their performance numerical models can be applied, particularly in case of sensitive ecosystems. Simulations and tests on pilot loops can be carried out, forecasting thermal changes of the surface water in the near and far field caused by heat emissions as well as by optimising anti-fouling treatment.

The purpose of modelling is to study any physical-chemical impacts and adapt the results of this modelling to the facilities in order to reduce these impacts to the greatest possible extent. It is particularly important to study:

- water withdrawals and discharges,
- the visual aspects of the site,
- the development of plumes,
- the thermal and chemical impacts on the receiving environment.

The objective of the pilot loop tests is to define the optimum treatment of cooling water both with regard to scaling and to any biological developments. To do so, pilot facilities representing real commercial operating conditions are installed on the site for about one year. This makes it possible to take account of variations in the quality of the waterway in the course of the seasons and to try out some options on a representative scale (e.g. choice of cooling tower fills, choice of alloy).

1.5 Selecting a cooling technique in order to meet environmental requirements

The environmental requirements can affect cooling systems application and are an additional step in the balanced selection of a new cooling system or in the optimisation of an existing cooling system. Generally, five major aspects with consequences for cooling systems selection can be distinguished:

- minimisation of energy use
- minimisation of heat emissions
- minimisation of large plume emissions
- minimisation of emissions to water
- minimisation of noise emissions
- minimisation of immissions to soil and terrestrial habitats

The aspects are cross-linked and each choice potentially has its consequences for one of the other aspects. The aim is to prevent emissions to the environment from routine operations. In this assessment step the differences between water-, air- and air/water-cooling should become clear as well as the operational consequences of the choice of a particular design or a particular material.

1.5.1 General comparison between air and water cooled systems

Minimisation of the environmental aspects is often translated into a comparison between water- and air-cooling systems. It has been advocated earlier in the document that a judgement of water versus air cooling should not be made in a general sense as this leaves out the local constraints that might limit the use of either system. However, it could be opportune to consider or reconsider water requirements of a cooling system in view of programmes on water

conservation and of the increasing demand on water with good quality for other purposes (civil and industrial) than cooling.

The economical turning point in the choice between dry air cooling and water cooling systems is not fixed and according to literature will be somewhere between 50°C and 65°C (as end temperature) depending on the local climatic conditions.

Some general remarks have been made in a comparison of the features of dry air cooling and wet cooling systems with the same required cooling capacity: [tm001, Bloemkolk, 1997]

On space requirements:

- Air-cooling demands space because of the low specific heat capacity of air. The space can be kept to a minimum by installing air-coolers above other process equipment or a pipe bridge;
- Air-cooling systems have limits to their location as they cannot be placed too close to buildings because of the resulting air-circulation, blockage of air-supply and the danger of recirculation;

Maintenance costs

- Generally maintenance costs for air cooling are considered to be lower as they do not require anti-scaling and mechanical cleaning of the water-contact surface area and do not require additional surface area to compensate for surface loss caused by pollution on the water side;

Process control

- Control of the temperature of the process is easier with air-cooling or with a recirculating flow than with once-through cooling, where the balance of water inlet and outlet restricts the controllability of the water flow and the temperature increase. With mechanical draught cooling or evaporative systems there is no limit to the available amount of air, and the airflow can be adjusted according to the process demand using fan cycling, a multi-fan installation or modulating capacity control;
- Control of leakage in cooling-water is easier to detect, although detection of leakage in condensers is reported to be more difficult. Usually this affects the efficiency of the process.

1.5.2 Design factors and choice of materials

Following the BAT “approach”, the design of the cooling system and the choice of materials to be used are an important preventive step. Both can affect the operation as the required amount of direct energy consumption, the occurrence of controlled (water treatment) and uncontrolled (leakage) emissions to the environment, noise emissions, and the direction of heat emissions (water or air). Also, the selected design and materials will require a certain level of investment. Again, the balance is sought between the level of prevention of emissions by design and used materials and the investment costs involved. This again is a site-specific and complex matter in which the following factors are taken into account:

- type of operation (e.g. once-through or recirculating)
- design of cooler and layout of cooling system (direct/indirect)
- pressure level (condenser)
- composition and corrosiveness of the cooling water
- composition and corrosiveness of the medium to be cooled
- required longevity and costs

A range of materials is available and, in order of increasing resistance, most commonly used are carbon steel, coated (galvanised) steel, aluminium/brass, copper/nickel, adequate types of stainless steel and titanium. Within these groups a further sub-classification on the quality is

used. Especially resistance to corrosion, mechanical erosion and biological pollution is greatly determined by the quality of the water combined with possible conditioning agents.

In Annex IV some considerations on the selection of material are given for once-through and open recirculating systems. For each industrial cooling system a similar assessment can be done. In case of water and water/air systems the material that can be selected depends on both the coolant and the process medium, whereas with primary closed circuit dry cooling, the process medium is more important.

It is obvious that for different parts of the installation different materials can be used. The quality of material least sensitive to the corrosiveness of the water or to the conditions of the process is preferred. If more sensitive materials (alloys) are chosen, the consequence can be that a complex cooling water treatment and control program is needed, which will lead to emissions and costs.

Table 1.7 shows an example on the effect caused by differences in design. Three towers are designed for the same cooling performance and the same required environmental performance. The choice for a cooling system means different sizes, but in particular a difference in energy costs as about 7 kW more is needed for the closed circuit cooling tower to be able to give the same performance with the same sound power level. In this case costs of operation may lead to choose one of the other options. For other design factors similar comparisons can be made, which may lead to different effects favouring another option.

Table 1.7: Comparison of different cooling systems with a required maximum sound power level [tm139, Eurovent, 1998]

	Mechanical draught wet cooling tower	Closed circuit cooling tower	Hybrid closed circuit cooling tower
Climate:			
dry bulb temperature	26 °C		
wet bulb temperature	18 °C		
Given Duties:			
Capacity	1200 kW		
inlet temperature	38 °C		
outlet temperature	32 °C		
Flow	47.8 l/s		
sound power level	90 dB(A)	90 dB(A)	90 dB(A)
Specific Data:			
Length	3.7 m	3.7 m	5.2 m
Width	2.8 m	2.4 m	2.0 m
Height	3.2 m	4.2 m	3.0 m
Fan power	5 kW	11 kW	5.0 kW
Spray pump power	1 kW	2.2 kW	1.0 kW

1.5.3 Options for a technological change of existing systems

For a new cooling system, there will be more flexibility to select between complete systems and to assess the alternative options, whereas for an existing installation a change of technology often is a drastic solution. Sometimes in specific cases, it is possible to change the technology, but the number of options to reduce emissions via technological solutions is limited for existing installations. As the BAT “approach” considers that prevention of emissions prevails, taking into account also the economical aspects, change of technology is an option that should be considered before the optimisation of operating a cooling system is to be further assessed. In the

following paragraphs observations and experiences by suppliers are presented to give examples of possible optimisation steps in the BAT “approach” (See also Annex XI).

1.5.3.1 Retrofit – reasons and considerations

Retrofitting existing installations can be considered for the following reasons:

1. replace existing technology by a different technology with lower operating demands,
2. replace outdated technology equipment by modern equipment with higher efficiency, and
3. modify existing equipment to improve performance or to meet additional demands.

Different from the selection of a new installation, where the site parameters can be more or less defined, in retrofit scenarios usually the following number of parameters is fixed:

- space - the retrofit installation must fit into the existing space,
- the availability of operating resources – the new installation should not exceed the operating resources, which were needed for the old one, new infrastructure would result in an increase in costs, and
- legislative restrictions – environmental impacts, like sound criteria, usually have to be at the same level or below the ones of the old installation.

Space is often an important reason for retrofitting itself. If a plant or building will be built new on an existing space-restricted site, it could be a solution to select a new type of cooling system, which can be placed on the roof of a building or which needs less space than the old one.

The preferred solution would be a new installation with lower operation needs, so that the retrofit is also associated with lower operating costs. Lower operating cost will be one of the main reasons for retrofitting. It is preferred, however, to consider a retrofit scenario, which reduces the emissions as well as the consumption of operating resources. In general this will require higher investment cost. Considering the operating cost savings and any potential reduction in emissions, larger investment costs can pay off in short periods of time.

All retrofit scenarios have to consider both the cooling technology and the process to be cooled. Both have to be seen as one system. Changes in the cooling system may have effects on the process and vice versa. The first aim of any retrofit must be to maintain, or if possible improve, the efficiency of the process to be cooled. On the other hand, changes in the process to be cooled will also result in different demands on the cooling system. This could be another important reason for retrofitting.

Changes in the process to be cooled can result in a change of demands on the cooling system.

- Due to new technology less waste heat is generated by the process, less cooling capacity is needed (example: computer terminals, processes with friction).
- The temperature level of the waste heat has changed, both to higher or lower temperatures (example: incineration processes).
- Larger parts of the generated heat of the process are recuperated, so less waste heat has to be removed to the environment.
- The temperature sensitivity of the process is increased, a more efficient cooling system is needed.

Table 1.8 summarises the options for technological upgrading that, according to suppliers information, can be considered to be technically easy (E), possible (P), difficult (D), not possible (NP), or does not apply (NA). Generally, each system has a varying number of options for retrofit. NP-E is an indication that the application of an option is largely dependent on the specific situation, in which the cooling system operates. (See also Chapter 3 and Annexes).

Table 1.8: Technological upgrading options for existing systems (pers. comm.)

Option	Industrial cooling systems ¹					
	OTCS	OWCT	OWDCT	CCWCT	CCDCT	CCWDCT
General	E	E	E	E	E	E
Improve capacity	E	E	D	D	D	D
Reduce kW _e	D	E	D	E	D	D
Reduce water-use	NA	NP-E	D	NP-E	NA	D
Reduce plume	NA	NP-E	NA	E	NA	NA
Reduce noise	NA	E	D	E	D	E
Reduce drift	NA	E	E	E	NA	E

Notes:
¹System code (see also Chapter 2):
 OTCS – once-through cooling system
 OWCT – open wet cooling tower
 OWDCT – open wet/dry cooling tower
 CCWCT – closed circuit wet cooling tower
 CCDCT – closed circuit dry cooling tower
 CCWDCT – closed circuit wet dry cooling tower

There are many possible ways to retrofit a cooling process and some typical scenarios along with their relevant considerations are listed in the following paragraphs.

1.5.3.2 Change of heat transfer technology

Usually, lower operational costs associated with a new technology or legislative restrictions are major reasons for the replacement of one heat transfer technology by another technology.

A typical example is the replacement of a once-through system by a recirculating system, saving on operating costs (water and sewage) and following restrictions on heat emissions to a surface water. The economic performance of the recirculating system depends on the specific costs for water, sewage and electrical energy. Assuming average water and sewage costs of 1 [€/m³] and electrical energy costs of 0.1 [€/kWh], the operating costs in this example are 38800 € for the once-through system and 48000 € (2100 € for water and 27000 € for energy) for the recirculating system. The annual saving is 34000 €, which is higher than the investment costs of 21000 €. If the balance favours the environment in the first place and investment costs will be much larger than annual costs, the investment recovery period will become an important factor.

In this example both the environment with respect to water requirements and the company benefit from a change in technology at the same time. The environmental costs however are due to additional energy requirements for extra fan and pump energy. Water use in this example is by large affected by the evaporation loss which has been calculated by assuming that they amount to 1.8% of the circulation per 10K of cooling (see Annex V.3).

This example merely shows how to approach changes in technology. With different price levels the outcome will be quite different and may favour the once-through system. For example, in Italy, where electricity cost is about 0.05 [€/kWh] and water cost for an open circuit 0.01 [€/m³] against 0.1-0.2 [€/m³] for a closed circuit, the once-through systems would be more favourable from an economic point of view.

Table 1.9: Example for conversion of a once-through system into a recirculating system [tm139, Eurovent, 1998]

Example: air compressor 500 kW	Once-through system	Recirculating system
inlet temperature	15 °C	27 °C
outlet temperature	35 °C	35 °C
flow rate	6 l/s	15 l/s
annual operating hours	1800 h	1800 h
evaporation loss	-	1400 m ³ /a
blow down	-	700 m ³ /a
annual water use	38800 m ³ /a	2100 m ³ /a
extra fan and pump energy	-	15kW
investment cost	-	€ 21000

If a change of the cooling configuration is considered, the effects on the overall efficiency must be taken into account. If possible, the efficiency should be increased. For temperature sensitive processes, it needs checking whether a cooling technology can provide lower end temperatures at the same level of safety.

The example of replacing a water-cooled condenser with an open cooling tower by an evaporative condenser shows an effect on end temperature and system efficiency. Such a technological replacement can potentially reduce the condensing temperature by 4 – 6 K depending on actual conditions. The efficiency gain of such retrofit can be estimated in order of magnitude of 12 – 15 % of the power requirement of the refrigerant compressor [tm139, Eurovent, 1998]

For temperature sensitive applications in the medium temperature range, the introduction of hybrid systems could be favourable, where water use and/or water and sewage costs have to be reduced. Such a change, generally, does not increase electrical demand, but can reduce the annual water consumption considerably. Depending on actual conditions and required size, hybrid concepts may require additional space.

1.5.3.3 Replacement of outdated heat transfer technology by modern one

Often a change of cooling technology for different reasons is not suitable. However, also a modification of the existing technology could lead to better efficiency, better performance, less emissions and lower operating costs. Development of air moving systems and heat transfer surfaces, as well as the application of more durable construction materials, are main reasons for replacement scenarios.

As there is usually no change in process temperatures (same technology) the main focus in this scenario is to reduce operating resources and environmental impacts as well as to achieve an extension of equipment's life. Equipment's life extension of more than 10 years can be realised by the use of new durable materials. It is very likely that any equipment installed 15 or 20 years ago, can now be replaced by modern equipment with higher operating efficiency and better environmental and economic performance.

A typical example for improvement of once-through cooling systems is the application of the more efficient plate and frame heat exchangers. For evaporative cooling systems for example, major developments have taken place to improve the performance of fill packs and of air moving systems, resulting in a more compact design with higher energy efficiencies. For air-cooled systems, new technology to shape fins in various ways has achieved similar results. An example of what could be the effect on energy use if applying better efficiency is illustrated in

Table 1.10. In this case the investment costs need to be balanced with the yearly operation costs for energy use and maintenance of fill.

Table 1.10: Example for conversion of an outdated mechanical draught wet cooling tower into modern design
[tm139, Eurovent, 1998]

Example: Mechanical draught wet cooling tower	Outdated design: induced draught concept with <u>low-efficiency fill</u> and fan system	Modern design: induced draught concept with <u>high-efficiency fill</u> and fan system
Capacity	1200 kW	
Inlet temperature	38 °C	
Outlet temperature	28 °C	
Wet bulb temperature	21 °C	
Water flow	28.7 l/s	
Fan power requirement	7.5 kW	4 kW
Energy consumption for fans	9 MWh/yr	4.8 MWh/yr
Investment cost	-	€ 14000

1.5.3.4 Upgrading existing heat transfer technology

Often it is not necessary to replace the whole cooling system. The performance of existing cooling systems can also be improved by upgrading. Major components or accessories of the system are replaced or repaired, while the existing installation remains in situ. Upgrading can increase system efficiency and reduce the environmental impact. Examples of upgrading are new and more efficient fill packs of cooling towers and the application of sound-attenuation.

The cases in Table 1.11 and Table 1.12 should be considered as simplified illustrations. For an integrated assessment of the environmental gain other factors should be considered as well. For example, with the replacement of cooling tower fill, the environmental costs for the old fill that has to be disposed of must be included also.

Table 1.11: Example for replacement of outdated fill of a mechanical draught wet cooling tower with modern high efficiency fill
[tm139, Eurovent, 1998]

Example: mechanical draught wet cooling tower	Outdated fill	High efficient fill
Capacity	3600 kW	
Inlet temperature	38 °C	
Outlet temperature	28 °C	
Wet bulb temperature	21 °C	
Water flow	86.1 l/s	
Existing cell floor space	26 m ²	
Fan power requirement	22.5 kW	13.5 kW
Energy consumption for fans	81 MWh/yr	48.6 MWh/yr
Investment cost	-	€ 29000

That not all changes have only positive effects can be observed from Table 1.12 where a considerable reduction of the noise level has been achieved. However, noise abatement usually leads to fall of pressure, which must be compensated by a higher performance of the fans. This in its turn raises the direct energy use of the cooling system. It will be a matter of local

preference whether a lower energy use or a lower noise level prevails. Investment and maintenance costs should be compared with reduced costs for energy consumption.

Upgrading the operational strategy is another example of efficiency improvement. The on and off cycling of fans can be changed into modulating control with frequency converters. This can result in significant savings of electrical energy, which, depending on conditions, can be 70% and more.

Investment costs for upgrading can differ greatly and depend on the type of upgrading and the age of the existing installation. The investment is accompanied by lower operating costs as a result of a higher efficiency. Investment costs for upgrading will generally be lower than those for technology changes or replacements of equipment.

Table 1.12: Example for the improvement of acoustic performance by addition of sound attenuation
[tm139, Eurovent, 1998]

Example: mechanical draught wet cooling tower	Existing wet cooling tower	Upgrading with sound attenuation
Capacity	1200 kW	
Inlet temperature	38 °C	
Outlet temperature	28 °C	
Wet bulb temperature	21 °C	
Water flow	28.7 l/s	
Fan power requirement	15 kW	18kW
Sound power level	90 dB(A)	81 dB(A)
Investment cost	-	€ 12000

1.6 Economic considerations

Costs are always among the most important factors for the selection of a cooling system and can only be assessed on an individual project level. Three important types of costs can be distinguished:

- investment costs,
- maintenance costs,
- operating costs related to energy (and water) requirements,
- environmental costs, such as taxes and costs for waste disposal.

The absolute costs and the relation between the different costs vary and depending on the cooling system. The cooling system with lowest investment costs is not necessarily also the system that requires minimal operating resources. Technical solutions to minimise resource consumption often lead to higher investment cost.

Therefore, it is important that economic considerations not only focus on simple investment cost comparisons, but also on operating costs of a cooling system. For power plants, operating costs are linked to the overall energy efficiency. The financial effect of a variation in efficiency caused by the choice of a different cooling system must be assessed. Generally for power plants, the comparison of different solutions is done using the earlier mentioned techno-economic method using an ‘actualised’ or ‘valoridated’ ratio that varies between countries. [tm056, Caudron, 1991].

2 TECHNOLOGICAL ASPECTS OF APPLIED COOLING SYSTEMS

2.1 Introduction

This chapter gives brief description of the principles of some of the cooling systems configurations used in European industry. Within these configurations a variety of applications can be found all aimed at meeting process, site, environmental and economic requirements. The size and type of heat exchanger, type of fans and operational practice also vary. The different types of cooling systems can be classified by different criteria. The standard literature uses the following criteria:

- dry air-cooled and evaporative wet cooled - according to the dominating thermodynamic principle – respectively sensible heat transfer and a combination of latent and sensible heat transfer. In evaporative cooling the two principles are coupled, but the main part of heat is transferred latent, at dry cooling only sensible heat transfer takes place.
- open or closed systems – in an open system the process medium or the coolant is in contact with the environment; in a closed system the process medium or the coolant circulates inside the tubes, coils or conduits and does not have contact with the environment.
- direct or indirect systems – in a direct system there is one heat exchanger where coolant and medium to be cooled exchange heat; in an indirect system there are at least two heat exchangers and a closed secondary cooling circle, between the process or product to be cooled and the primary coolant. Due to the additional heat exchanger, indirect systems have a higher approach (about 5 K). Direct and indirect systems are also known as primary and secondary systems. In principle every direct cooling system can be transformed into an indirect system and this option is considered in situations where leakage of the process medium would endanger the environment.

Direct contact cooling systems (not to be confused with direct/indirect) are not described in this BREF, because their characteristics depend strongly on the industrial process they are applied to (e.g. hot steel). Another type of cooling is a once-through system with barometric condensers, in which a gas flow is cooled directly by dosage water over it. They can be found in the food industry. These systems are not covered in this document, either are systems that use vacuum techniques or specific refrigerants, such as HCFC.

In practice a variety of names used for both cooling equipment and cooling configurations found inside and outside of Europe. Nomenclature is often linked to the purpose of the application and in power generation plant typology refers to the condensing process (see Annex XII). In general, the following list of systems commonly applied by European industry can be derived from the above-given principles.

- once-through cooling systems (with or without cooling tower)
- open recirculating cooling systems (wet cooling towers)
- closed circuit cooling systems
 - air-cooled cooling systems
 - closed circuit wet cooling systems
- combined wet/dry (hybrid) cooling systems
 - open hybrid cooling towers
 - closed circuit hybrid towers

For closed recirculating cooling systems, further distinction can be made between small off-the-peg applications and large, tailor-made ones that are constructed or assembled on site.

Generally, once-through systems and open recirculating systems are applied to larger plants in the power and the (petro-) chemical industries.

The term tower is applied to both shell type constructions (e.g. large natural draught) and cell type constructions, which can be small and can be found in roof type applications.

For comparison, some technical and thermodynamic characteristics of the most common industrial cooling systems are summarised in Table 2.1. These data are an example derived from a given number of assumptions (see legend to the table). It is important to realise that approaches can vary and depend largely on the design of the heat exchanger and the temperature of the ambient air. The minimum end temperatures of the process medium will vary accordingly. For power stations, the approach is calculated in a different way (see Annex I).

Table 2.1: Example of technical and thermodynamic characteristics of the different cooling systems for industrial (non-power plant) applications [tm139, Eurovent, 1998]

Cooling system	Cooling medium	Main cooling principle	Minimum approaches (K) ⁴⁾	Minimum achievable end temperature of the process medium ⁵⁾ (°C)	Capacity of industrial process (MW _{th})
Open once-through system - direct	Water	Conduction/Convection	3 – 5	18 – 20	<0.01 - > 2000
Open once-through system - indirect	Water	Conduction/Convection	6 – 10	21 – 25	<0.01 - > 1000
Open recirculating cooling system - direct	Water ¹⁾ Air ²⁾	Evaporation ³⁾	6 – 10	27 – 31	< 0.1 - >2000
Open recirculating cooling system - indirect	Water ¹⁾ Air ²⁾	Evaporation ³⁾	9 – 15	30 – 36	< 0.1 - > 200
Closed circuit wet cooling system	Water ¹⁾ Air ²⁾	Evaporation + convection	7 – 14 ⁷⁾	28 – 35	0.2 – 10
Closed circuit dry air cooling system	Air	Convection	10 – 15	40 – 45	< 0.1 – 100
Open hybrid cooling	Water ¹⁾ Air ²⁾	Evaporation + convection	7 – 14	28 – 35	0.15 - 2.5 ⁶⁾
Closed hybrid cooling	Water ¹⁾ Air ²⁾	Evaporation + convection	7 – 14	28 – 35	0.15 - 2.5 ⁶⁾

Notes:

- 1) Water is the secondary cooling medium and is mostly recirculated. Evaporating water transfers the heat to the air
- 2) Air is the cooling medium in which the heat is transferred to the environment.
- 3) Evaporation is the main cooling principle. Heat is also transferred by conduction/convection but in a smaller ratio.
- 4) Approaches of heat exchanger and cooling tower must be added
- 5) End temperatures depend on the site's climate (data are valid for average middle European climate conditions 30°/21°C dry / wet bulb temperature and 15°C max. water temperature)
- 6) Capacity of small units – with a combination of several units or specially built cooling, systems higher capacities can be achieved.
- 7) Where an indirect system applies or convection is also involved the approach in this example increases with 3-5K leading to an increased process temperature

The example of Table 2.1 shows that configurations have different temperature ranges and that the desired temperature range for a process might need a certain configuration. For reasons of space and costs, dry air-cooling systems are generally not used for very large capacities, whereas water cooling can be applied for the discharge of heat up to 2000 MW_{th} or more.

For condensers the approaches are higher. The approach for once through systems corresponds to the sum of the “terminal difference” and the temperature rise of the cooling water. The term “terminal difference” to the temperature difference between the temperature of the steam

entering the condenser (or the condensed steam leaving the condenser) and the temperature of the cooling medium (water) leaving the condenser. The values differ between 3 and 5 K. The applicable data are presented in Table 2.2.

Table 2.2: Examples of capacity and thermodynamic characteristics of different cooling systems for applications in power industry

[Comment EDF/[tm056, Caudron, 1991][tm056, Caudron, 1991][tm056, Caudron, 1991]]

Cooling system	Applied approaches (K)	Capacity of power generating process (MW _m)
Open once-through systems	13-20 (terminal difference 3-5)	< 2700
Open wet cooling tower	7-15	< 2700
Open hybrid cooling tower	15-20	< 2500
Dry air cooled condenser	15-25	< 900

This chapter gives an overview of the most common industrial cooling systems and an indication of their associated environmental aspects. More detailed information on heat exchangers and material can be found in Annexes III and V, as well as in the documents in the reference list. In the following paragraphs the technical terms will be used that have been most commonly encountered in the literature. As an aid to consulting references, an indication will be given where other terms are also used.

2.2 Heat exchangers

Heat exchangers are the crucial heat transferring elements, being part of both the process to be cooled and the cooling system. After the heat exchanger, different systems are used to discharge the heat into the environment. Two types of heat exchangers are commonly in use: the shell and tube type (the most common) and the plate and frame type.

2.2.1 Shell and tube heat exchangers

There is a lot of experience with this kind of heat exchanger in the process industry and it has proven reasonably reliable. There is a range of different designs, where tubes run straight or in a U-form or where the heat exchanger is particularly designed for high-pressure conditions, high temperatures, operating with steam or thermal fluids. Usually the tubes contain the cooling water and the process medium moves around the tubes within the shell. For a more extensive discussion on shell and tube heat exchangers see Annex II.

2.2.2 Plate and frame heat exchangers

Plate and frame heat exchangers are increasingly used for a range of applications in sugar refineries, (petro-) chemical industry and power plants. They are particularly suitable for use at a lower approach as well as in cold applications (< 0°C). However, these exchangers are less suitable for cooling of steam and high gas volumes, and in situations where there is danger of sedimentation and/or fouling and for high pressure differences between the process fluid and the coolant. Some designs have a double construction to guarantee leakage-free operation, but this is reported to be very difficult to maintain. Plate and frame heat exchangers are economic as they can be much more compact (e.g. circular) than shell and tubes with the equivalent exchange surface area.

2.2.3 Environmental issues of heat exchangers

From an environmental point of view the following issues are important for both types of heat exchangers:

- adequate design for efficient heat exchange;
- proper construction to prevent leakage of the process fluid into the cooling medium;
- choice of material for the efficiency of heat transfer, for resistance to corrosion in water and to corrosion due to the process medium;
- possibility of using mechanical cleaning devices.

2.3 Once-through cooling systems

2.3.1 Direct once-through cooling systems

Technical description

In direct once-through systems, water is pumped from a source (e.g. a river, lake, sea or estuary) via large water inlet channels directly to the process. After passing heat exchangers or condensers the heated water is discharged directly back into the surface water. The heat is transferred from the process to the coolant through the partition wall in the form of tubes in a shell & tube or in a plate & frame heat exchanger. Once-through systems are identified by various names. For example, in the paper industry, many mills refer to their once-through cooling water as "mill supply". [tm010, Betz, 1991]

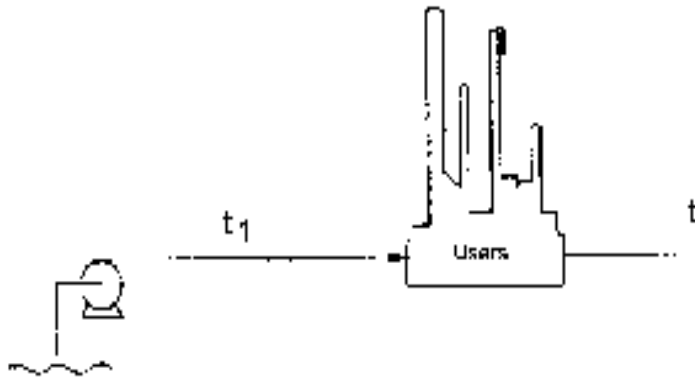

Figure 2.1: Schematic representation of a direct once-through cooling system [tm001, Bloemkolk, 1997]

Cooling capacity

Once-through systems are designed mostly for large cooling capacities ($>1000 \text{ MW}_{\text{th}}$), but may also be designed for small systems ($< 10 \text{ kW}_{\text{th}}$). Typical water flows for large power plants to cool 1 MW_{th} are in the range $0.02 \text{ m}^3/\text{s}$ ($\Delta T = 12\text{K}$) to $0.034 \text{ m}^3/\text{s}$ ($\Delta T = 7\text{K}$). With once-through cooling, low end temperatures can be reached with a corresponding approach of 3-5K.

Environmental aspects

For once-through systems the major environmental aspects mentioned are:

- the use of large amounts of water
- heat emission,
- the risk of fish intake,
- sensitivity to bio-fouling, scaling or corrosion
- the use of additives and the resulting emissions to water,
- energy consumption, mainly for pumps,
- the risk of leakage from the process stream, and
- the silting-up of sieves at water intake.

Application

Once-through systems are used by large industrial processes such as the power generating industry, chemical industry and refineries. The water used for once-through cooling is mostly surface water. For smaller scale uses, such as pump cooling, tap water or groundwater is also used. A reliable source of water near the site and at a suitably low temperature is an essential condition for once-through systems. The quality of the surface water and the discharge limits can also affect the applicability, but generally water quality and water chemistry are less restrictive than in the case of recirculating systems. [tm005, Van Donk and Jenner, 1996]

2.3.2 Once-through cooling systems with cooling tower

Because of the power generating process operates under vacuum conditions, leakage in the condenser of a power plant generally means pollution of the process-water by the cooling water. On a number of sites, once-through systems can be found combined with a cooling tower to precool the discharge before it is emitted into the receiving surface water. This configuration is applied in situations where cooling water may recirculate and raise the temperature of the cooling water intake of the same plant or other industries. River capacity, tidal movement, plant-size and temperature of the surface water are also factors. This kind of precooling can be found at coastal power stations (estuaries) and inland at riverbanks.

Environmental aspects of open wet cooling towers will apply to these cooling systems. Biological growth and deposits have to be considered when choosing cooling tower fill. In general, cooling towers with wide spread fill or splash fills are applied.

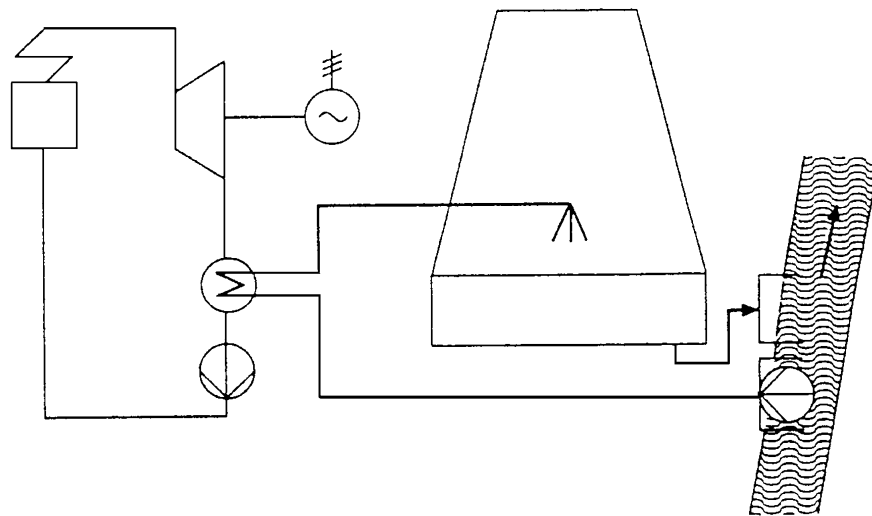

Figure 2.2: Schematic representation of a direct once-through cooling system with a cooling tower applied in power industry
[tm132, Eurelectric, 1998]

2.3.3 Indirect once-through cooling systems

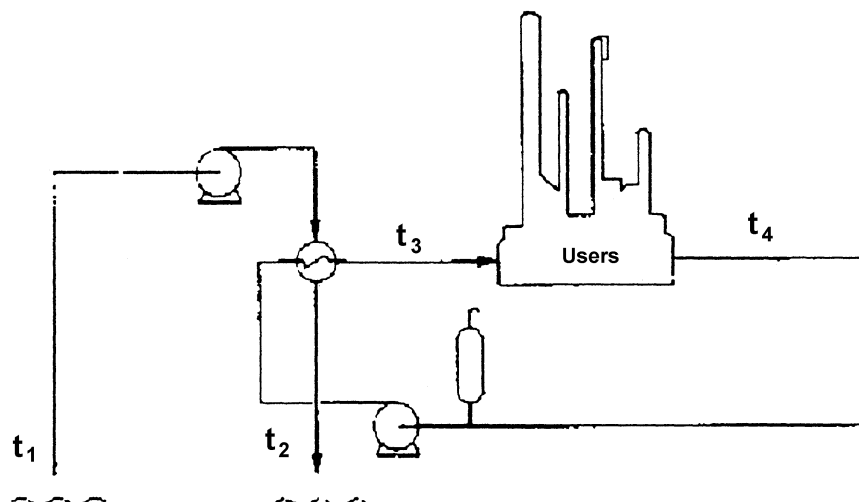

Figure 2.3: Schematic representation of an indirect once-through cooling system
[tm001, Bloemkolk, 1997]

Technical description

This cooling configuration is similar to the direct once-through system, but is indirect because there is no direct transfer from the process fluid/vapor to the coolant that is discharged. Here, the term secondary cooling system is also used. Heat is transferred from the process medium or product to a coolant that circulates in a closed circuit (t_3 and t_4). The coolant in this secondary cooling circuit transfers its heat via heat exchangers to the coolant (e.g. surface water) that flows through the heat exchangers only once, the so-called primary cooling water (t_1 and t_2). This water is directly discharged into the surface water, whereas the secondary coolant remains in the closed circuit.

Cooling capacity

With indirect once-through cooling, the same low end temperatures can be reached, but due to the extra heat exchanger the approach can increase by another 3-5K, depending on the efficiency of the heat exchanger.

Environmental aspects

See also direct OTS. The design means that the risk of discharge of leaked process fluids to the surface water is of minimal or zero.

Application

The indirect once-through cooling water system is used where there is a high environmental risk if process fluids leak into the cooling water. Availability and quality of the surface water are also important for this cooling system. This system also creates a thermal load in the receiving surface water. A variant of the indirect once-through system is to recycle a part of the water of the primary cycle. This part is cooled by air before it is mixed with new incoming cooling water. This extra cooling capacity can be used in periods of the year when insufficient cooling water is available.

Generally, as a result of the extra heat exchanger (i.e. higher approach) the process end temperatures that can be reached are not as low as with direct once-through cooling.

2.4 Open recirculating cooling systems

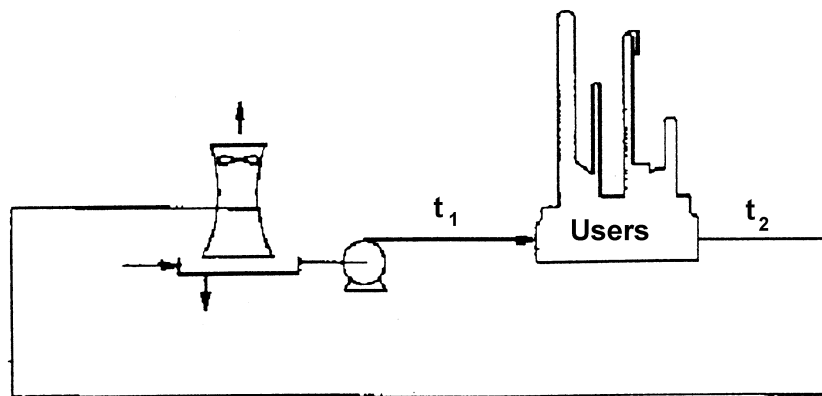

Figure 2.4: Schematic representation of an open recirculating system
[tm001, Bloemkolk, 1997]

Technical description

Open recirculating cooling systems are also referred to as open evaporative cooling systems. In these systems, cooling water that is led through the heat exchanger(s) systems is cooled down in a cooling tower where the majority of the heat is discharged to the environment. In the cooling tower the heated water is distributed over the cooling tower fill and is cooled by contact with air and collected in a reservoir, after which it is pumped back to the heat to be reused as a coolant. The air movement is created naturally or by means of fans that push or pull the air through the tower. Cooling of the water is a result of evaporation of a small part of the cooling water and of sensible heat loss by the direct cooling of water by air, also called convection. The wet and dry bulb temperatures largely influence the level at which these systems can operate.

Most, but not all of the water that is cooled in the tower is recirculated and can be used as cooling water again. The main causes of water loss are evaporation, blowdown (windage, drift, purge (intentional blowdown) and leaks. Intentional blowdown is the draining of water from the circuit necessary to avoid thickening of the cooling water (Annex VI). To compensate for the blowdown and evaporation, water is added and this is the so-called make-up. Generally, the make-up water flow used by an open recirculating system is about 1-3% of the flow of a once-through system with the same cooling capacity. For the power industry this can be 1-5%. This is equal to a requirement of approximately “0.25% x cooling range”, which is the make-up water quantity as a percentage of the circulating water flow. Blowdown generally ranges from 0.15-0.80 m³/s per 1000 MWth cooled. (Water-half time varies between one hour and four days.) This system requires sufficient quantities of water available all year around and generally cooling water treatment is necessary.

Cooling capacity

Open recirculating systems are mainly used for industrial applications with a heat capacity ranging from 1-100 MWth, but also for power stations with much larger capacities. These systems are mostly applied inland where insufficient water is available, or where no further rise of the water temperature of the receiving water is acceptable, a situation found alongside rivers with low flows in warm summer months [tm005, Van Donk and Jenner, 1996]. Wet cooling towers transfer to the atmosphere about 80% of the residual heat in the form of latent heat (water vapour) and about 20% by sensible heat [tm132, Eurelectric, 1998]. Approaches of 4K are technically and economically achievable between 15 and 30°C. Approaches and minimum end temperatures depend on the climatic conditions on site.

Environmental aspects

The environmental aspects of recirculating systems depend particularly on the type of cooling tower and the way it is operated. They are:

- cooling water additives and their emission through the blowdown to surface water,
- use of energy for pumps and fans,
- emissions into air,
- plume formation, condensation and ice-formation,
- noise,
- waste due to replacement of cooling tower fill, and
- human health aspects.

Application

Recirculating systems are applied in a wide range of processes. One feature is the reduction of heat load to a receiving waterway by changing the direction of the discharged waste heat from the surface water to the air. Another feature is the reduction of the amount of water used for cooling. A common practice therefore is the modification of once-through cooling systems into open evaporative cooling systems by applying one or more cooling towers.

Open recirculating configurations are:

- open wet cooling towers
- open hybrid or wet/dry cooling towers

2.4.1 Natural draught wet cooling towers

Construction

Large towers nowadays are shell type and made of reinforced concrete. The constructions are mostly hyperbolic-rotational shells having advantages in thermodynamic/statical aspects. Investment costs are high, whereas operational costs are comparatively low. Natural draught wet cooling towers are commonly used for large power stations and large industrial plants.

Water distribution system

The water returning from the heat exchanger is brought into the tower using a water distribution system. This system creates fine droplets or a water film. Uniform distribution enhances the heat exchange. Options are offered for partial operation of the water distribution system to lower the cooling capacity if needed. Also, winter operating modes are offered based on preheating of the cooling air.

Cooling tower fill

The fill section is the important part of each open wet tower, creating the contact surface for the exchange of heat from water to air. There can be film fill or splash type fill. Film fill usually consists of closely packed, corrugated, vertical sheets or sheets of organic materials, which cause the water to flow down through the tower in a very thin film. This fill is very efficient and can be used for most applications. Some types may require a certain water quality, because they are susceptible to fouling.

Splash type fill can be found in different configurations and can be made of a variety of materials (e.g. wood). Splash fill has a much lower efficiency than film fill, but is used particularly situations where the water is heavily contaminated or of poor quality, where film fill would have problems due to a contaminated surface. Where the suspended matter content is high, fibre cement sheets are also used.

Drift eliminators

To save water, drift eliminators are installed above the water distributors to prevent the water droplets from being entrained by the airflow. Nowadays, drift eliminators are made of a number

of materials, such as plastic or fibre cement, and designed in such a way that they cause minimal pressure drop.

Characteristics of natural draught wet cooling towers:

- airflow is a result of air density differences and of shape of tower as in a chimney construction;
- height is considerable (80-200 m.); [construction height as obstacle for people, aviation, electronic transmissions and plumes];
- there is no energy requirement for fans, unless fan assisted, which enables lower heights;
- it is designed with counter flow and internal fill, or cross flow and external fill (see Figure 2.5 and Figure 2.6);
- it requires a base load operation, i.e. tower being in operation for more than 60 % of the year in operation
- it is generally applied for a rejected heat capacity of more than 200 MWth, i.e. large plants such as power stations or large chemical plants;
- it offers an option for desulphurized flue gas discharge, using the cooling tower as stack avoiding reheating of the flue gas required for environmental reasons;



Figure 2.5: Natural draught wet cooling tower counter flow
[tm103, BDAG, 1996]

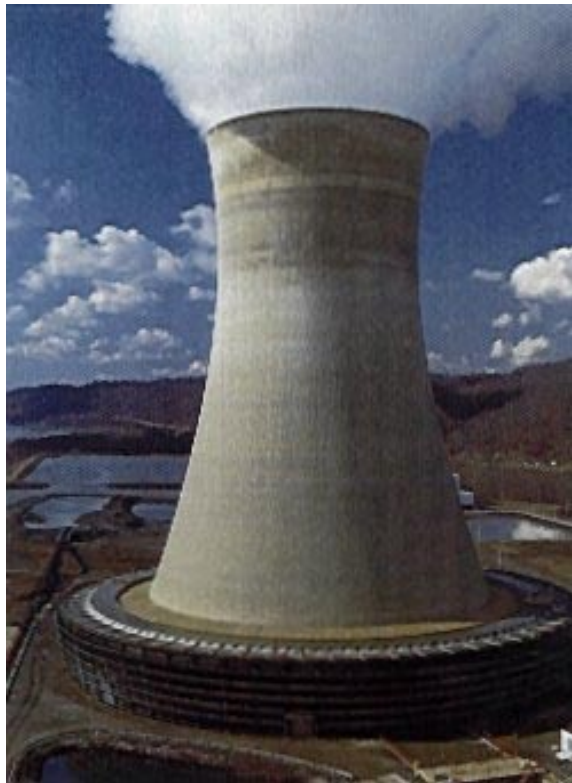

Figure 2.6: Natural draught wet cooling tower cross flow
[tm010, Betz, 1991]

2.4.2 Mechanical draught wet cooling towers

Construction

Mechanical draught cooling towers are applied in different types of constructions. A wide variety of materials is used for construction of these cooling towers, depending on size and type and the requirements with respect to the location, service life and capital expenditure. Larger ones can be built of reinforced concrete, smaller ones can vary considerably, but mostly consist of synthetic material, steel plate, clad steel constructions and in-situ or pre-cast concrete. For relatively smaller towers (5 MW_{th}) timber is still in use; it is cheaper, can be built at any time of the year and can be quicker to build than concrete towers.

It is also possible to use a modular system, i.e. several towers in parallel, in the same concrete structure. In this way the system can be operated in the most economical way, choosing the number of elements in operation, depending on ambient conditions and on the amount of heat.

Materials and type of construction and design affect the environmental performance of the cooling tower. Referring to shape and size or brand, a variety of names is used in the literature describing the use and application of these towers. Examples are the circular cooling tower and cell type cooling towers both in forced and induced draught designs.

Design of equipment for **water distribution, fill and drift elimination** can be different to that of the natural draught wet cooling tower, but the working principles are the same.

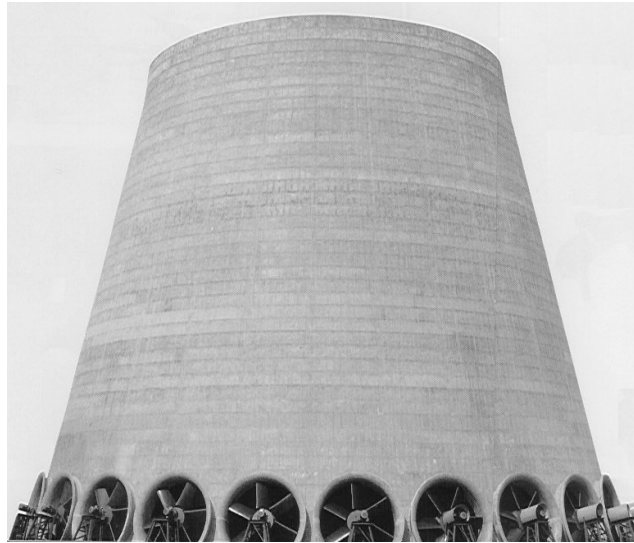

Figure 2.7: Fan assisted natural draught cooling tower
[tm103, BDAG, 1996]

Fans

Mechanical cooling towers use fans to create the airflow and consequently can be much smaller than the large natural draught type. A large number of different fan types is applied in mechanical cooling towers (dry, wet or hybrid). Depending on the requirements, fans vary in fan diameter, blade size and position (radial or axial). Additionally, one-speed or multi-speed drives enable flexible operation. The choice of the fan type and the drives will affect the energy demand and the sound emission level of the cooling tower. Depending on the way the airflow is created distinction is made between forced and induced towers.

The fan-assisted tower is a special design used in a number of cases where the local situation requires a lower tower.

2.4.2.1 Forced draught wet cooling towers

Characteristics of the forced draught cooling tower:

- fans at the base of the cooling tower push air through the tower;
- thermal performance is adjustable in steps or modulating;
- single-and multi-fan designs are applied;
- the cooling tower size is limited, requiring less space than a natural draught tower;
- tower can be adapted to surrounding terrain (rooftop installation);
- direct energy consumption is assumed to be low;
- it is usually designed with counter flow design;
- it can be designed for a wide variety of applications: for peak load and high heat rejection and from base load to medium load operating standard;
- it is applied for a rejected heat capacity from less than 100 kW_{th} to a heat capacity of more than approximately 100 MW_{th};
- capital investment is low compared to natural draught towers;
- when using mechanical draught cooling towers, regulations with regard to emission of noise, moisture (plume) and bacteria are to be observed.

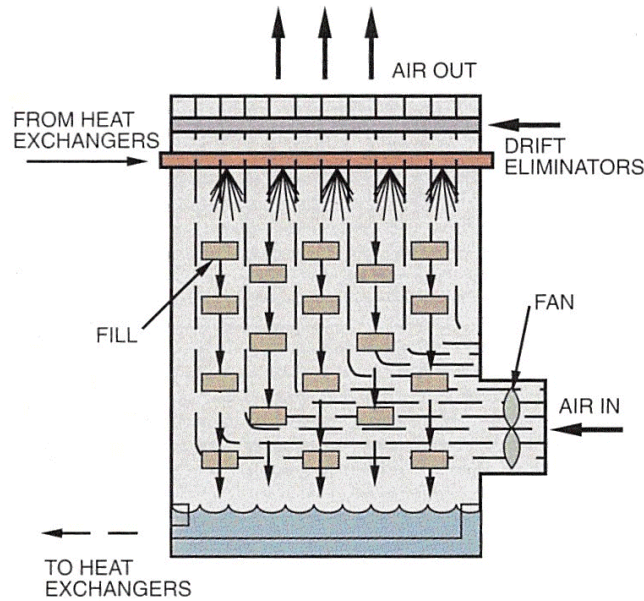

Figure 2.8: Schematic representation of a forced draught tower with counter flow design [tm010, Betz, 1991]

2.4.2.2 Induced draught wet cooling towers

Characteristics of the induced draught cooling tower:

- fans at the top of the cooling tower construction pull air through the tower;
- thermal performance is controllable within limits,
- a relatively simple construction is preferred (prefabricated elements, off-the-peg product),
- the cooling tower size is limited, requiring less space than a natural draught tower;
- cooling capacity can be enlarged by working with several sections
- tower can be adapted to surrounding terrain (rooftop construction);
- cost of direct energy consumption is assumed to be low,
- designed with counter flow or cross flow,
- it is used for a wide variety of applications: for peak load and high heat rejection and from base load to medium load operating standard; it is applied for a rejected heat capacity from approximately 100 MWth,
- capital investment is low compared to natural draught towers,
- when using mechanical draught cooling towers regulations with regard to emission of noise, moisture (plume) and bacteria are to be observed.

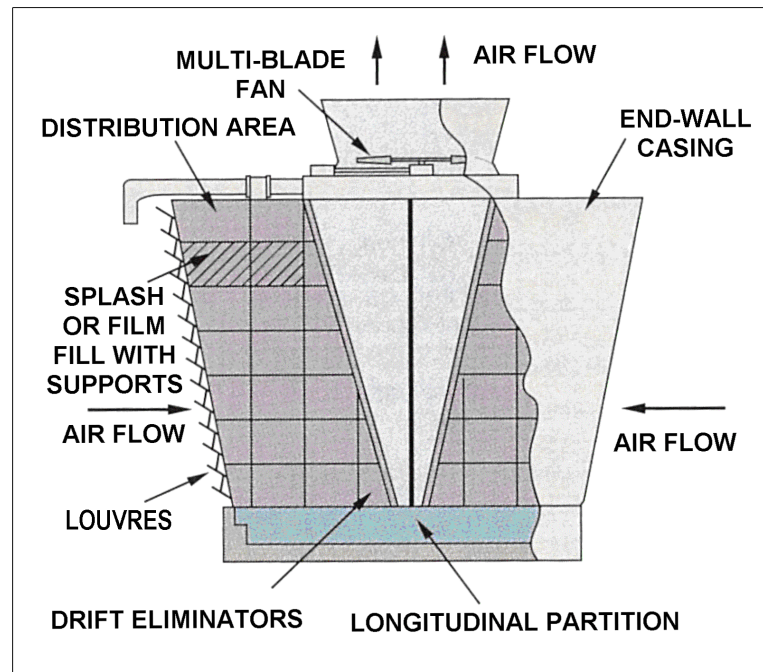

Figure 2.9: Schematic presentation of a cell type induced draught cooling tower, cross flow design [tm010, Betz, 1991]

2.5 Closed circuit cooling systems

2.5.1 Air-cooled cooling systems

In air-cooled cooling systems (or dry cooling systems) the substance (fluid, vapour) is circulated through coils, tubes or conduits, which are cooled by a passing air stream. Generally dry air cooling has the following applications:

- cooling of medium of nearly any chemical composition can be applied, requiring appropriate heat exchanger material only;
- in situations where cooling tower make-up water is not available or for a short period of time only and
- where formation of plume is not admissible.

Technical description

Depending on the application, closed circuit dry air-cooled systems consist of (finned) tube elements, coils or conduits of a condenser, fans with drives and a carrying steel construction or a tower. The process medium itself or a coolant (indirect system) is circulated through the tubes. An air stream is created, naturally or by fans, that flows past the tubes thus cooling the medium by conduction and convection. In almost all cases the air flows crosswise through the heat exchanger. The process medium passes the heat exchanger in a 'one-pass' or a 'multi-pass' configuration.

The process medium is a fluid, the cooling system is called an air-cooled fluid cooler. If a vapour (gas or refrigerant) is directly cooled down to condense to liquid, the cooling system is called an air-cooled condenser. Application can be in a mechanical or natural draught design.

A wide variety of corrosion-resistant materials is used for construction. The options for construction are numerous. Air cooling systems can be found as large independent units as well as smaller rooftop units. They can be horizontal, roof type rectangular, vertical or as a V-construction to suit the plant layout requirements.

Cooling capacity

In practice, air-cooling is often used to cool process flows at a high temperature level ($>80^{\circ}\text{C}$) down to a level at which water-cooling becomes more appropriate. The driving force of the heat exchange is the temperature difference between the cooling air and the process flow. The maximum design temperature of the cooling air may in practice only be exceeded a few hours per year. The design temperature depends on dry-bulb temperature and climatic conditions are very important.

Because the heat capacity of air is low (1.0 kJ/kg.K) and the coefficient of conduction and convection is low, a lot of air is needed and a larger heat exchanging surface is required than with water cooling. For this reason, fins are often placed on the pipe surface to increase the effective heat exchange surface. Based on economic considerations a minimum approach of $10\text{-}15^{\circ}\text{C}$ is used in the design of air coolers. This generally results in higher end temperatures (minimum $40\text{-}45^{\circ}\text{C}$), although in areas where higher ambient air temperatures occur, the approaches and the end temperatures exceed the average values mentioned in Table 2.1 and Table 2.2. For indirect configurations the approach ($13\text{-}20^{\circ}\text{C}$) and the achievable end temperatures ($50\text{-}60^{\circ}\text{C}$) will increase accordingly.

Environmental aspects

The major environmental aspects are noise and energy use for driving the fans. No water is being used, unless it is used as secondary coolant in an indirect design. However, being closed, this water requires little or no maintenance.

Cleaning of the outside of the (finned) tubes is necessary and sometimes problems can arise due to the accumulation of airborne debris and small insects.

Application

Dry air-cooled heat exchangers are applied in a wide variety of industries in small and large sizes. They are applied for product cooling in the chemical and petrochemical industries, for vacuum condensation in power stations and for exhaust cooling.

For the same capacity, dry air-cooling needs a larger surface than a wet cooling system and dry systems are generally considered to be more expensive. In the power industry, dry air-cooling is therefore considered in specific situations where power generation is planned at locations with insufficient water supply for wet cooling.

2.5.1.1 Natural draught dry cooling tower

Characteristics of a natural draught dry cooling tower are:

- base load operation, i.e. more than 60% of the year in operation,
- heat rejection more than 200 MWth, i.e. large plants such as power stations, large chemical plants, etc.,
- application in situations where absolutely noiseless operation is required,
- application in situations where cooling tower make-up water is not available or available for a short period of time only.

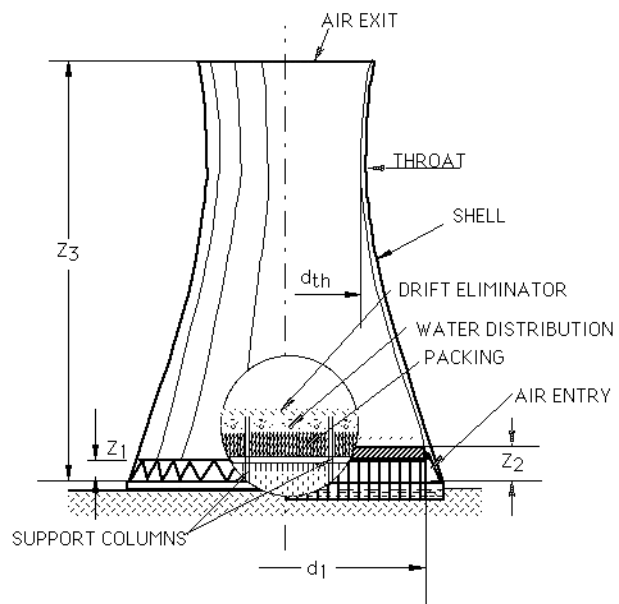

Figure 2.10: Schematic presentation of principle of a dry natural draught cooling tower [Eurovent, 2000]

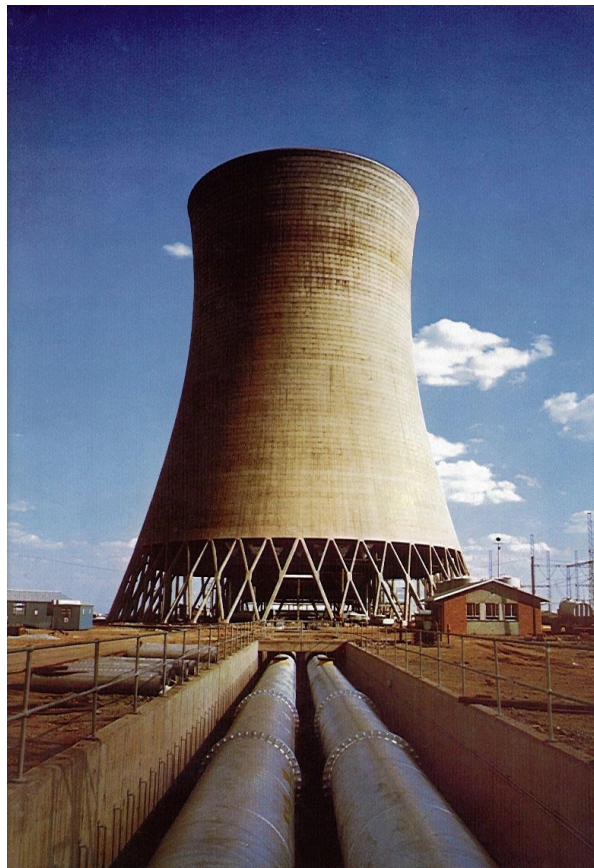

Figure 2.11: Example of natural draught dry cooling tower for a power plant application [VGB, 2000]

2.5.1.2 Air-cooled liquid cooling systems

Characteristics of an air-cooled liquid cooler tower are:

- thermal performance adjustable by fan control;
- closed circuit necessary;
- forced and induced draught both applied;
- cost of internal power consumption assumed to be higher than for wet cooling towers;
- low heat rejection, i.e. less than $100 \text{ MW}_{\text{th}}$;
- change in cooling medium temperature nearly linearly to the (dry bulb) air temperature must be acceptable for the process to be cooled;
- operating costs nearly entirely consisting of energy costs;
- environmental aspects in particular are noise and energy.

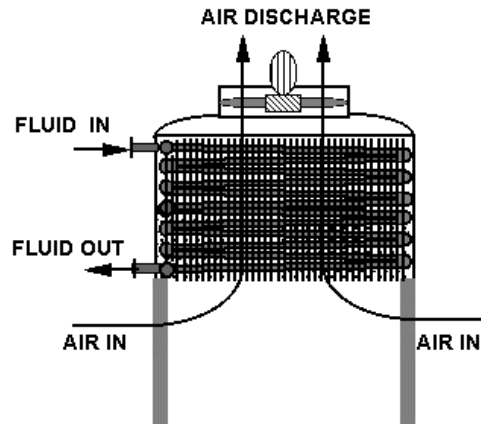

Figure 2.12: Schematic presentation of the principle of a dry air-cooled cooling system [Courtesy of Eurovent, 2000]



Figure 2.13: Example of a dry air-cooled liquid cooler in a chemical process [Pers. archive]

2.5.1.3 Air-cooled steam condensers

Air-cooled condensers (see Annex XII) are widely applied in the power industry and chemical plants for condensation of steam. The air is drawn in by fans under the condenser elements and pushed through. The passing air cools down the steam entering the condenser tube bundles (see Figure 2.14). In an indirect system the condenser is cooled by a cooling water stream which in turn is cooled in a natural draught cooling tower.

Characteristics of air-cooled steam condensers are:

- heat rejection for small to large installations,
- no cooling water needed,
- cost of direct energy consumption is assumed to be higher than for wet condensers or wet cooling towers,
- requires relatively low overall height,
- short exhaust steam pipes possible,
- considerable space requirement in the immediate vicinity of the steam generator,
- adaptation to load and temperature variations necessary over large ranges, which requires variable fan speed operation,
- environmental aspects in particular are noise and energy.

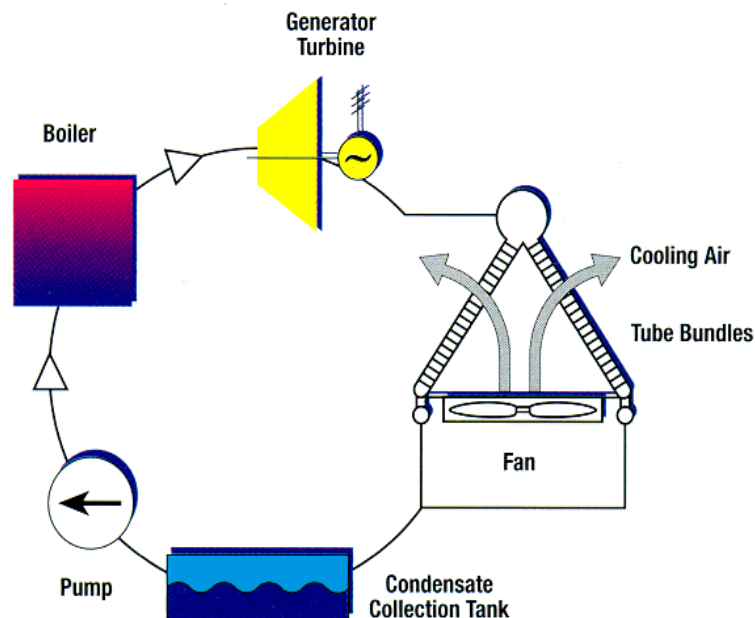

Figure 2.14: Schematic presentation of the principle of a direct air-cooled condenser [Balcke Dürr, 2000]



Figure 2.15: Example of an air-cooled condenser for condensation of turbine exhaust steam [tm111, BDAG, 1996]

2.5.2 Closed circuit wet cooling systems

In closed circuit cooling systems, the medium to be cooled is circulated in a closed circuit without contact with the environment. The medium is led through a coil (primary circuit). The coils are wetted from the outside (secondary or spray circuit). The heat is conducted from the medium to the spray water (sensible heat transfer). The evaporation of a small part of the water leads to evaporative cooling and the heat is transferred from the water to the air. There is an additional sensible heat transfer from the coil to the air. In practice at evaporative cooling sensible and latent heat transfer are always coupled. The wetting water is treated to avoid damage to the equipment. Evaporative losses, drift and windage cause concentration, so some de-sludging (blowdown) is needed and some make-up water has to be added.

Cooling capacity

The heat transfer capability is lower than for open systems due to the lower heat transfer capacity of the coil. By combinations of units, larger capacities of 150-400 kW_{th} to 2.5 MW_{th} can be achieved. Approaches of 4 K are typically achievable. The advantage is a contaminant-free closed primary cooling loop (true for all closed cooling), which in some cases eliminates the need for internal heat exchangers. In terms of resources, the energy requirements for the spray water loop have to be considered. With closed circuit cooling, end temperatures between 25-30°C are achievable, depending on the climatic conditions of the site [tm139, Eurovent, 1998]

Temperatures in the water film at heat exchanger surfaces are up to 5°C higher than the temperatures of the bulk water, which typically range from 40 to 50°C, although temperatures up to 70-80 °C can also be encountered in practice.

Environmental aspects

If closed circuit cooling systems use water as a secondary cooling medium, this is generally alkalised demineralised water or potable water. Residence times in these systems can be up to 6 months. Make-up water is needed only when leakage and evaporation have occurred at pump packings or when water has been drained to allow system repairs. Because only little make-up water is needed, this can usually be of high quality, and as a result, scale deposits are not a problem. Scaling can be caused by the water used on the outside of the tubes or coils and treatment (cleaning) may be needed. [tm010, Betz, 1991]. Depending on the technical concept, the mode of operation and the climatic conditions, plume formation may occur. Water can be

saved, as the tower can be operated as a dry tower when the ambient temperatures are low. Fan noise may be an issue.

Application

Closed circuit cooling systems are used in many applications. They are well suited to the cooling of gas engines and compressors and can provide a reliable method of industrial process temperature control [tm010, Betz, 1991]. They can be applied for both large and small applications. Applications can be found as liquid coolers (e.g. lubricating oils, cooling water for compressors), as gas coolers (e.g. diesel engines, process gas) and as air-cooled condensers (combined cycle plants, steam turbines).

If the process medium in the coil or tubes is a vapour (gas or refrigerant) to be cooled down to condense into liquid, this cooling system is also called an evaporative condenser.

2.5.2.1 Mechanical draught wet closed circuit cooling systems

Characteristics of the mechanical draught wet closed circuit cooling systems:

- heat rejection for small to large installations,
- low cooling temperatures can be achieved,
- compact design compared to air-cooled equipment,
- low energy requirements,
- need for water supply and spray water circuit,
- plume suppression achievable by air discharge plume abatement coils and/or dry operation in winter,
- environmental aspects, in particular water treatment and effluent disposal.

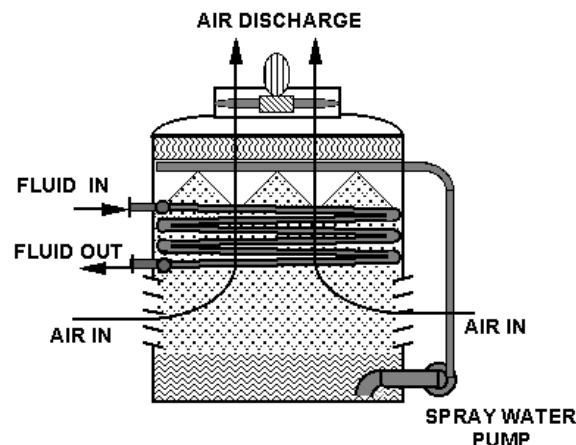

Figure 2.16: Schematic presentation of the principle of a closed recirculating wet cooling tower with induced draught
[Eurovent, 2000]

2.5.2.2 Evaporative steam condensers

Characteristics of evaporative steam condensers:

- heat rejection for medium to large installations,
- lower condensing temperatures than with air-cooled steam condensers,
- low energy requirements,
- generally higher than air-cooled steam condensers but with a smaller footprint,
- environmental aspects in particular are water treatment and effluent disposal.

2.6 Combined wet/dry cooling systems

2.6.1 Open wet/dry (hybrid) cooling towers

Technical description

The open wet/dry cooling tower or hybrid cooling tower is a special design that has been developed as an important solution to the problem of cooling water use and of plume formation. It is a combination of a 'wet' and 'dry' cooling tower or, in other words, of an evaporative and a non-evaporative process. The hybrid cooling tower can be operated either as a pure wet cooling tower or as a combined wet/dry cooling tower, depending on the ambient temperature. The heated cooling water first passes through a dry section of the cooling tower, where part of the heat load is removed by an air current, which is often induced by a fan. After passing the dry section, water is further cooled in the wet section of the tower, which functions similarly to an open recirculating tower. The heated air from the dry section is mixed with the vapour from the wet section in the upper part of the tower, thus lowering the relative humidity before the air current leaves the cooling tower, which (almost) completely reduces plume formation above the tower.

Optimising the effect of a hybrid cooling tower means optimising the amount of dry heat transfer to meet the plume control requirements. At the same time the wet section is being used for the major part of the cooling.

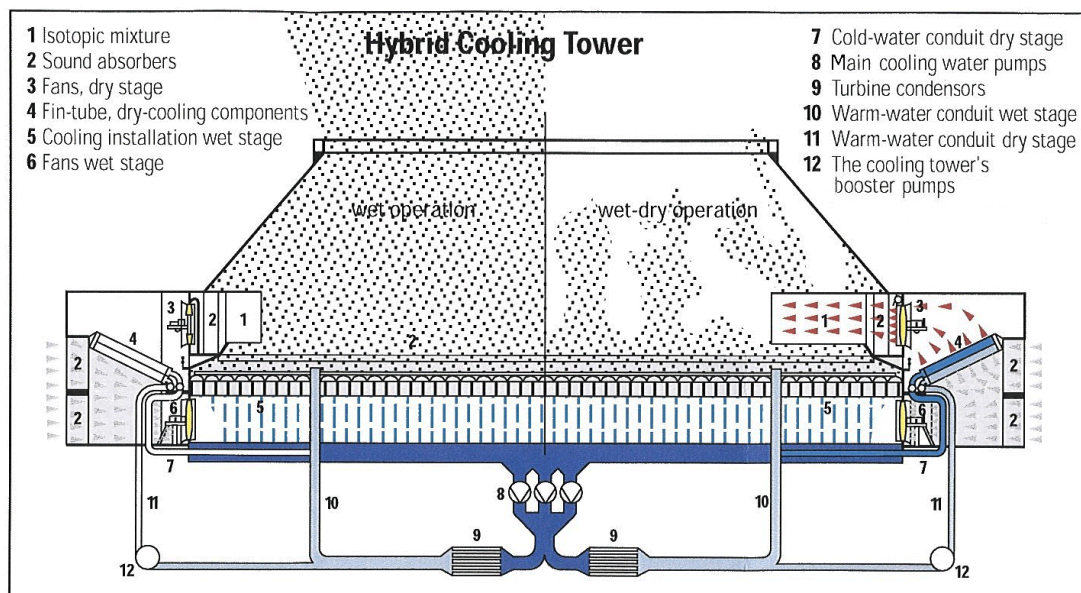

Figure 2.17: Schematic representation of hybrid cooling tower principle (example applied in power industry)

[Eurelectric, 1999]

Characteristics of open hybrid cooling towers are:

- base load and partial load operation for all capacities
- cooling medium being water only
- cooling tower make-up water required for most of the operating time
- thermal performance being the same as in the case of wet cooling towers
- reduction in make-up water quantity
- regulations for environmental protection, e.g. reduction in overall height (due to fan assistance) and plume abatement
- sound attenuation equipment required due to noise regulations.

To operate a hybrid cooling tower efficiently a number of devices are used:

- variable speed fans
- closing devices for air inlet openings (such as louvres or sliding gates)
- valves for water flows to the wet and dry sections
- bypass systems
- booster pumps (for special constructions)
- system for mixing of the wet plume with dry plume.

Hybrid tower construction

Currently only mechanical draught type hybrid cooling towers are available. The hybrid cooling tower is different from the characteristic open wet tower design in that it has a dry and a wet section, each with its own air inlet and corresponding fans. Hybrid cooling towers can be found as package cooling towers, large round cooling towers with forced draught fans or as cell-type cooling towers with induced draught fans. Fill, water distribution system, drift elimination, and sound attenuation are features common to both tower designs.

Wet/dry cooling towers of the mechanical draught type are fitted with internal mixing systems to mix the wet and dry airflows. They can be automatically controlled according to the heat load, water flow, ambient air and plume conditions.

Cooling capacity

They can be built as package cooling towers, induced draught or forced draught cooling towers and – on a larger scale - as cooling towers of the cellular type or circular type with the heat rejection ranging from $< 1 \text{ MW}_{\text{th}}$ up to $2500 \text{ MW}_{\text{th}}$.

Environmental aspects

The major difference between a hybrid cooling tower and a conventional cooling tower is its comparatively lower water use (which is make-up water) amounting to 20% less than that of a wet cooling tower [tm132, Eurelectric, 1998].

The resulting annual energy consumption of a mechanical draught hybrid cooling tower can be reduced to a level of 1.1 to 1.5 times that of a comparable mechanical draught wet cooling tower since in nominal conditions, airflow is almost double (wet and dry sections). Natural draught cooling towers of the wet/dry design are under consideration.

Application

A decision to install a hybrid cooling tower is made in the light of site-specific requirements (limitation of height and plume reduction) and several can be found in the power industry, especially in Germany and in United Kingdom (in cogeneration systems). Its use is restricted to temperature ranges of 25-55°C, because above 55°C precipitation of calcium carbonate is observed to occur more easily on the tubes. This does not mean that no precipitation occurs below 55°C and some care must be taken in using this as a rule of thumb.

2.6.2 Closed circuit hybrid cooling systems

Technical description

For closed circuit cooling hybrid systems, characteristics can be described in a similar way as for closed recirculating wet cooling systems concerning fans (axial and radial), airflow direction (cross or counterflow) and noise abatement systems (see § 2.4). Generally, these units have a small space requirement. Three technical modes can be applied to closed circuit hybrid cooling towers: sprayed finned coils, adiabatic cooling or combined systems.

Environmental aspects

Closed circuit hybrid cooling towers combine the advantages of closed loop cooling with significant savings of water when compared to conventional closed circuit wet cooling towers.

Compared to closed circuit dry cooling towers they offer the advantage of lower cooling temperatures. In terms of size, energy consumption and noise emission they compare with conventional closed circuit wet cooling towers. Depending on their design (sprayed finned coils) special attention may need to be paid to the quality of the water treatment. Additional costs can be more than offset by the significant saving of water, as such products require the use of water only during a very short period of the year. Closed circuit hybrid coolers also significantly suppress and, in some designs, even eliminate plume formation.

2.6.2.1 Sprayed (finned) coils

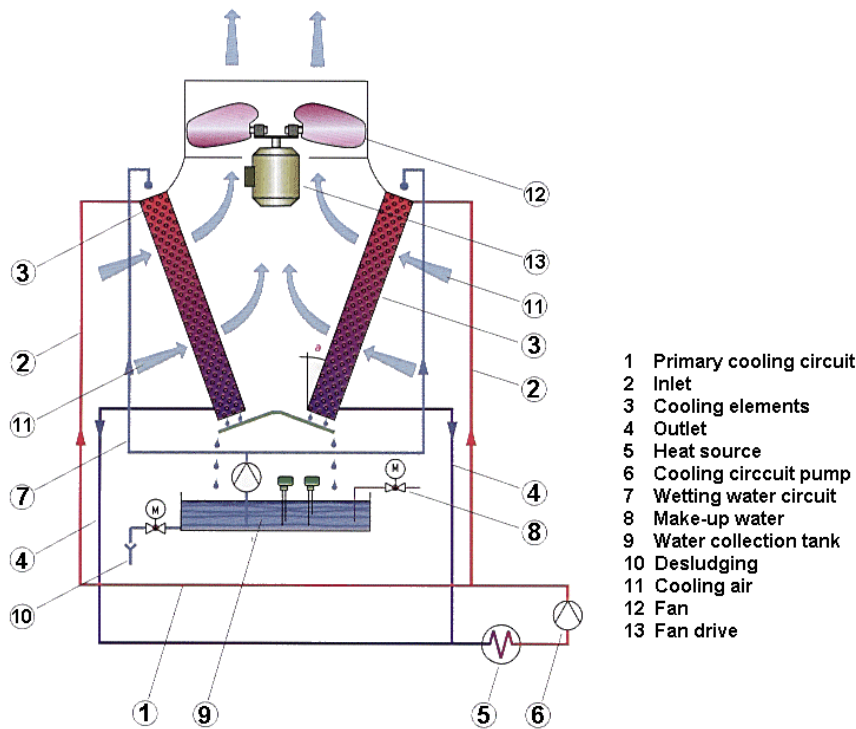

Figure 2.18: Schematic presentation of the principle of a closed circuit hybrid cooling tower

In a closed circuit cooling tower the process medium runs through cooling elements (a tube/plate bank or the finned coil) in a closed loop, the primary cooling circuit. These cooling elements are wetted via a secondary water circuit and air is simultaneously moved over the elements to create evaporative heat. The cooling water that runs off the elements is collected in a basin and can be recirculated a number of times, sometimes using another cooling tower or after blowdown (see Figure 2.19). In an indirect configuration, the medium that runs through the primary cooling circuit is not the process medium but another coolant which in turn cools the process medium in a second heat exchanger.

2.6.2.2 Adiabatic coolers, wetting and pre-cooling the air that cools the coils

In the adiabatic mode the fluid to be cooled bypasses the prime surface coil. The cooling water trickles down the wet deck and the air passing the deck is wetted with as much moisture as it can take up. The wetted air passes the finned coils and will take up more heat than dry air would do. Compared to conventional evaporative cooling equipment the water consumption is much reduced. (See Figure 2.19)

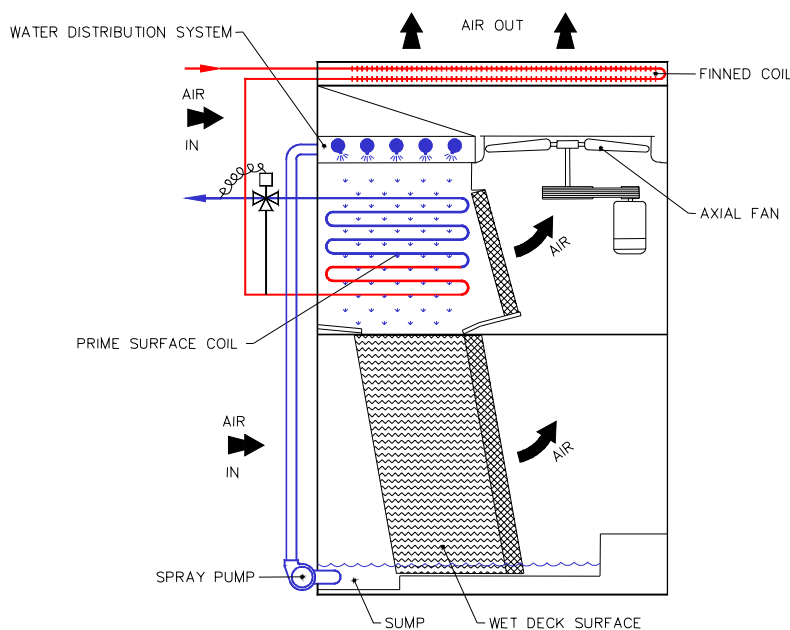

Figure 2.19: Combined dry/wet operation of a hybrid cooling system
[tm151, BAC, 1999]

2.6.2.3 Combined technology

In combined technology the finned coils, the sprayed prime surface coil and the wet deck are all used. In the dry mode it is then possible to close all water sprays and lead the medium to be cooled through both the finned coils and the prime surface coils, both cooled by dry air only. In the wet/dry mode the medium after passing the dry coils passes the sprayed prime surface coils before returning to the process as cooled medium. The warmed water trickling down from the prime coils will fall over the wet deck surface. Air is drawn in and passes both the prime surface coil and wet deck surface, where it is saturated and picks up heat. As it passes the finned coil more heat can be picked up (see also Figure 2.19).

2.6.2.4 Costs of hybrid systems

In the application of hybrid systems reference is always made to the investment and operating costs involved. In general hybrid systems require higher investment costs. Costs of plume suppression vary depending on the cooling system. Compared to a cooling tower with the same cooling performance, Fluor [1995] calculated that for an open wet cooling tower installation of 300 MW the cooling installation costs are about 2.5 times as high as for cooling towers without plume suppression. For closed circuit wet cooling towers, costs for plume suppression are reported to be 1.5 to 2 times as high as for towers without plume suppression (Eurovent). The costs have to be adjusted for cost savings on water intake and operational flexibility. The annual costs for water, including water treatment and electricity can represent in some cases just about 10 % of the annual costs of a cooling tower. These economic considerations depend of course on the individual application and the prices of water and energy [tm139, Eurovent, 1998]. Cost indications by the power industry show levels of EUR 40000 to 70000 per MW_{th} for mechanical draught type hybrid cooling towers. In this sector this means an installation cost level of 1.3-1.6 times that of towers of similar capacity without plume suppression.

2.7 Recirculating cooling systems

The descriptions given above of major cooling configurations explain the cooling principles and the different associated technical designs that are applied in industry, depending on requirements of process, site and environment. Some key definitions have been explained in the introduction as well as the difference between dry and evaporative cooling, and between open and closed systems is used in the systems' descriptions. The application of the criteria direct and indirect, however, can lead to much confusion if they are not defined in the context of recirculating cooling systems.

2.7.1 Direct recirculating cooling systems

As stated earlier, in direct cooling systems there is only one heat exchanger level where coolant and process medium exchange heat and where the coolant (water or air) is in contact with the environment. Leakage through the wall between process medium and coolant (air or water) would therefore mean that process medium is discharged into the environment or that, in vacuum conditions (condensers), the process is affected. Thus, although the cooling of the coolant as it is done in a cooling tower is also a process of heat exchange, it is still considered a direct system.

The example of the open cooling tower cooling the water circuit of a water-cooled condenser is therefore a direct system (although, as mentioned, leakage will affect the process rather than the coolant).

2.7.2 Indirect recirculating cooling systems

The key element to define an indirect system would be that leakage of the process would not contaminate the coolant that is in open connection with the environment. This means two levels of cooling.

In the case of an open recirculating cooling tower, the water leaving the tower would exchange heat in a heat exchanger with water that is in a closed loop. The water in the closed loop will leave this heat exchanger to enter another heat exchanger, where it exchanges heat with the process medium.

In closed recirculating cooling towers the same principle is followed and the coils or tubes are filled with water, which is cooled by water and /or air. The cooled water enters a heat exchanger or a condenser within process to exchange heat with the process medium.

Where closed recirculating cooling systems operate in winter and need protection against freezing, the closed circle usually contains not just water, but also a refrigerant or water mixed with anti-freeze. In fact, those systems can again be classified as direct systems as the refrigerant could pollute the cooling medium, which is in open contact with the environment.

2.8 Costs of cooling systems

For each configuration a cost indication has been given, but calculations made of the costs of cooling systems show a wide variation and it can be concluded that the differences in costs between the different systems do not necessarily indicate the least expensive variant. Of the different factors that in the end influence the costs, the users' requirements and the legal requirements are very important. For this reason an estimate of the feasibility of a system or the application of a technique should be made for each individual case. Energy prices always have to be taken into account. They will be important, for instance, in those cases where heat recovery is being considered.

An important aspect in calculating the costs of a cooling system and of the possible improvements is the comparison between the initial investment costs of a system or an applied measure and the resulting annual costs. In practice, high investment costs can lead to lower maintenance costs, but also to higher annual fixed costs, which can be an obstacle to investment itself. For the sake of comparison, costs also have to be expressed in terms of the heat capacity the system is designed for (kW_{th} or MW_{th}).

For industrial (non-power plant) applications [tm001, Bloemkolk, 1997] listed a number of cost-determining elements for both water-cooled and air-cooled systems, calculated total costs and compared the different systems. The elements and the approach followed are explained below and the results have been summarised in Annex X. For power plants a different model applies, which is explained in Annex XII.

Elements

Generally the following cost-determining elements have to be taken into account:

Table 2.3: Cost elements for water and air cooling systems
[tm001, Bloemkolk, 1997]

Cost type	Cost elements	Water cooling systems	Air cooling systems	
Fixed	Heat exchanger(s) (type, size and model)	x	x	
	Heat exchanger (material)	x	x	
	Pipelines in process, tube-bridges	x	x	
	Pumps/reserve pumps	x	x	
	Inlet facilities	x		
	Tube intake/drainage	x		
	Outflow facilities	x		
	Cooling tower(s) (possible)	x	x	
	Fans	x	x	
	Sound attenuation	x	x	
	Indirect system (extra heat exchanger, pipes, pumps)	x	x	
	Variable	Water (groundwater, tap water)	x	
Water discharge fee		x		
Leakage monitoring		x	x	
Water conditioning		x		
Energy consumption (pumps and fans)		x	x	
Maintenance		x	x	

Methodology

Different methodologies have been developed for cost comparisons between different cooling systems. The method used is described briefly in Annex X.

Comparisons

Comparisons should always be made based on the same operational conditions and for the same capacity and expressed per MW_{th} dissipated.

Calculations have shown that cost sensitivity is to a large extent determined by the investment level and the consumption of energy. The variation in the costs of heat exchangers (shell & tube) due to the chosen configuration and to the choice of material is very important. Cheap materials and models determine the calculated lower limits. Special materials determine the upper limit. It should not be forgotten here that good materials could considerably decrease the costs of maintenance and operating and of the use of chemicals.

Calculated as annual costs, investments and operational costs differ significantly. Factors such as (make-up) water requirement and price, and energy consumption are influential. The choice of material also has consequences for the annual costs. Where dry air-cooling is applied, the achievable end temperature is important and the lower the required end temperature, the more expensive air-cooling will become. With water cooling, the low endtemperature is less important for cost estimations, unless small approaches are used in the calculation.

Table X.2 in Annex X shows the ranges of costs of various large industrial cooling systems. From the data used in this method the operational costs of an open wet cooling tower were shown to be higher than for dry air-cooling. The investment costs for air cooling, on the other hand, were generally higher than for the other systems. It further suggests that, particularly with cooling water systems, higher investment can mean lower operational costs (maintenance, conditioning).

On the basis of the above data, it can be concluded that the cost differences between different systems do not necessarily indicate the least expensive variant. This clearly depends on the users' requirements and the requirements on emission levels set by the authorities. For this reason an estimate of what is feasible should be made for each individual case. The above data can be used as initial (general) indications and are illustrated in Annex X.

3 ENVIRONMENTAL ASPECTS OF INDUSTRIAL COOLING SYSTEMS AND APPLIED PREVENTION AND REDUCTION TECHNIQUES

3.1 Introduction

The environmental aspects of industrial cooling systems are different for each of the configurations described in Chapter 2. Direct and indirect energy consumption, emissions of heat and cooling water additives to the surface water, noise and plume formation are environmental aspects of cooling systems. In every case, the environmental importance of these issues (such as noise) should always be considered in the light of the total environmental performance including that of the industrial process to be cooled. Not all issues are equally important for every system, such as water requirements or plume formation, which play no role in dry cooling systems. The issues that potentially are relevant and should be taken into account by the permit writer in considering the industrial cooling system are qualitatively characterized and summarized in Table 3.1. Obviously, where appropriate measures are taken, the issue will become less relevant, but this has not been taken into account in this table as it will be part of the discussion in the following chapters. The character and level of emissions to the environment are not only a result of the applied configuration, but to a large extent depend on the way the system is operated and the way in which the resources that are needed to operate a cooling system are being managed.

This chapter discusses the environmental aspects and microbiological risks (or health risks) that may have to be taken into account when an application for an environmental permit has to be considered. At the same time, the principles of the techniques are described that can be considered in the determination of BAT. In many cases the cooling system will be an existing installation and it is obvious that the options for improvements are limited compared to greenfield situations. Generally, the design of the process and the selection of the appropriate cooling technology and design can reduce consumption and prevent much of the emissions to the environment. In individual cases it will be a matter of setting the priorities for what should be done or can be done, where site-specificity plays a major role.

To determine BAT, the BAT-”approach” is described separately for each environmental issue and each technique, taking into account potential cross-media effects. The evaluation follows the general “approach” outlined in Chapter 1. It starts with reducing the demand for cooling and the discharge of heat to the environment. It is followed by the assessment of options for the minimisation of the resources dedicated to the prevention or reduction of emissions, bearing in mind that this will also lead to easier cooling process operation:

1. prevention by technological options:
 - integrated technical measures
 - change of configuration
2. prevention by optimisation of systems operation
3. application of end-of-pipe technology or additional techniques.

The environmental implications of each option are discussed and each technique is evaluated for its effect on total energy consumption. At first, it is illustrated how changes in cooling operations can affect energy consumption. Information on particular techniques and their performances is then given in the annexes.

Table 3.1: Environmental issues of the different industrial cooling systems
[tm001, Bloemkolk, 1997]

Cooling system	Energy Consumption (direct)	Water requirement	Fish ⁽²⁾ entrainment	Emissions to surface water		Air emissions (direct)	Plume formation	Noise	Risk		Residues
	(§ 3.2)	(§ 3.3) ⁽¹⁾	(§ 3.3)	Heat (§ 3.3)	Additives (§ 3.4)	(§ 3.5)	(§ 3.5)	(§ 3.6)	Leakage (§ 3.7)	Micro biol. risk (health) (§ 3.7)	(§ 3.8)
Once-through cooling (direct circuit)	Low	++	+	++	+(biocides)	--	--	--	++	--/low	+(⁶)
Once-through cooling (indirect circuit)	Low	++	+	++	+(biocides)	--	--	--	Low	--/low	+(⁶)
Open wet cooling tower (direct circuit)	+	+	--	Low	+(³)	Low (in plume)	+	+	+	+	--/low
Open wet cooling tower (indirect circuit)	+	+	--	Low	+(³)	Low (in plume)	+	+	Low	+	+
Open wet/dry cooling tower	+	Low	--	Low	Low ⁽³⁾	--	-- ⁽⁵⁾	+	Low	?	+
Closed circuit wet cooling tower	+	+	--	--	Low	Low ⁽⁴⁾ (in plume)	--	+	Low	Low	--/low
Closed circuit dry cooling	++	--	--	--	--	--/Low	--	++	Low	--	--
Closed circuit wet/dry cooling	+	Low	--	--	Low ⁽³⁾	Low	--	Low	Low	Low	--/low

Notes:

--	none/not relevant	1: paragraph in text
Low	relevance below average	2: other species can also be entrained
+	relevant	3: biocides, antiscaling, anticorrosion
++	highly relevant	4: potentially in case of leakage
		5: if properly operated no issue
		6: waste refers to sludge from water intake and from decarbonization

3.2 Consumption of energy

The energy requirement of industrial cooling systems can be considered as a direct or an indirect consumption. Direct consumption is the use of energy to operate the cooling system. The major energy users are pumps and fans. The higher the resistance that has to be compensated to maintain the required air or water flow, the more energy a cooling system requires.

If not properly operated, a cooling system may be indirectly responsible for an increased input of energy or raw material into the production process. To evaluate any change to a cooling system, the total energy balance of both the cooling system and production processes has to be taken into account.

3.2.1 Direct consumption of energy

Energy in cooling systems is required to pump the cooling water and/or to create airflow. It is expressed in specific energy consumption as kW_e per MW_{th} dissipated heat. The specific energy consumption can vary widely and depends on the configuration of the cooling system applied (design (approach temperatures), pumping pressure) and pattern of operation (year round, only summer or winter). Local circumstances will cause variation as well, where the same cooling system in warmer climates typically requires a higher energy input than in cooler climatic regions. In some cases, energy is required for the on-site preparation of additives. The major energy users in a cooling system are:

- pumps (used in all systems with cooling water) for water intake as well as for circulating the cooling water:
 - their energy use is determined by the flow rate, the amount of water that has to be pumped, fall of pressure in the process (number of heat exchangers, design), place where cooling water is supplied and drained off and the medium to be pumped (gas, fluid, solid).
 - indirect systems have two circuits and will therefore need more pumps.
 - in the case of a cooling tower, the lift is higher, which requires more energy in comparison with a once-through system.
- fans for ventilation are used in all mechanical cooling towers and mechanically cooled condensers:
 - their energy use is determined by the number, size and type of fans, the amount and the lift of the air,
 - dry systems in general need more air for the same cooling capacity than evaporative (wet) systems, although this does not necessarily lead to a higher energy consumption.

Energy use of associated activities

For an overall assessment of energy requirements of cooling systems auxiliary equipment essential to operate a cooling system should be included. Not many data have been reported. On-site production of cooling water chemicals such as ozone is reported as a typical example, where the production of 1 kg ozone, used for antifouling purposes, varies between 7 and 20 kWh depending on the generator. Given a minimum concentration required at the injection point between 0.5 and 1 g O_3/m^3 and the cooling water volume, it is possible to estimate the energy requirement.

3.2.2 Indirect consumption of energy

The energy consumption of the production process is referred to as the indirect energy consumption caused by the cooling process. With inefficient cooling the consumption will increase. A lower heat transfer (e.g. due to fouling) will raise the temperature on the process

side, requiring more energy, which will have to be generated on or off site. Cooling inefficiency leads to loss of product and will reduce the efficiency of the process.

In 1.2.1 and 1.4.3 the effects on temperature sensitive applications are discussed. Due to reduced cooling of the condenser, total energy conversion can be reduced by 0.25%, which is equal to a reduction of efficiency of about 0.4% per degree Celsius. If an open wet cooling tower is applied, rather than a once-through system, resulting in for instance a 5°C higher end temperature, at maximum 2% less power will be produced. If the difference in pumping energy required for the cooling tower were taken into account (which is 6-8 kW_e per MW_{th} cooled), it would cause an additional one-percent of efficiency loss. For a conventional coal fired power plant a 1% decrease means that efficiency would drop from 40% to 39.6%.

The evaluation of the environmental impact of cooling should include the evaluation of the indirect energy consumption. The consequences of a change in indirect energy consumption for the total energy consumption can be expressed as the effect of a temperature rise on the process side due to suboptimal cooling. This has been calculated and compared between the major cooling configurations [tm059, Paping, 1995]. The data in Table 3.2 represent direct and indirect energy use and CO₂-emissions of each cooling configuration. The three variables are considered to be a linear function of the following design parameters:

- cooling water flow
- pumping pressure
- pumping efficiency (inversely proportional)

In this example the data are calculated with a once-through system as the reference system for each of the cooling principles. The once-through system has a capacity of 100 m³/hour per MW_{th} (or 8.6°C per MW_{th}) and needs a pressure of 3 bar to pump the water to the required height. This requires about 10 kW_e/MW_{th}/year with a pumping efficiency of 75%. For the indirect once-through system, a pressure drop occurs and 4.5 bar extra has to be generated, requiring 15 kW_e/MW_{th}. A cooling tower system needs extra energy to lift the water over e.g. 8 m and in addition to this about 7 mwg over the nozzles. Compared to a once-through cooling system, this requires an extra 4.5 bar and 15 kW_e/MW_{th}.

Fans are assumed to need 15 kW_e/MW_{th}. If they are only operated in summer (4 months) the average energy required equals 5 kW_e/MW_{th}.

In the same table the indirect energy is expressed as a function of an increased cooling water inlet temperature. This will lead to an increased temperature on the process side. The factor representing this increase is calculated as 1.4 kW_e/MW_{th}°C (see Annex II). It means that per degree of increase of the temperature on the process side the required energy increases by a factor 1.4.

Knowing the total energy consumption for each cooling configuration, it is possible to express this consumption in levels of emitted CO₂ per discharged MW_{th}. The energy required in power generation to produce the energy consumed by a cooling system can be calculated. With an assumed efficiency of 40% to generate power, each kW_e input to operate the cooling system must be multiplied by 2.5, expressing the energy required to discharge energy (=cooling), or kW_e per kW_e (in ‰). For each ‰ an amount of CO₂ is being emitted. It is assumed that an average of 2000 (1500-2500) tonnes CO₂ per year per MW_e (continuous operation) is emitted or 2 tonnes CO₂/‰. (This figure is derived from Dutch emission data and depends on the fuel mix).

The data in Table 3.2 are within the ranges of relative energy uses generally found when comparing different cooling systems with similar cooling capacities. The data are not exact and should not be used as such. Nor do they imply that one system is less preferred than the other. What the table clearly shows is that the effect due to loss of efficiency of cooling can be considerable and that the consequences for the total energy balance can be made comparable. This table shows the importance of considering both the direct and indirect energy consumption when operating a cooling system.

Table 3.2: Example of a comparison of yearly specific direct and indirect energy demand of different cooling systems and the consequences for CO₂-emissions per MW_{th} [tm059, Paping, 1995]

Cooling system	Specific direct energy consumption (kW _e /MW _{th})			Increased T pump (°C)	Specific <u>indirect</u> energy consumption (kW _e /MW _{th})	Total energy consumption (kW _e /MW _{th})	E _{input} per E _{discharged} (in ‰)	CO ₂ (tonnes/yr/MW _{th})
	Pumps	Fans	Total					
Once-through -direct	10 (9-12)	-	10	0	0	10	25	50
-indirect	15 (12-18)	-	15	5	7	22	55	110
Open wet cooling tower	15 (13-17)	5	20	5	7	27	68	136
Hybrid cooling	15 (13-17)	8	23	5	7	30	75	150
Closed circuit cooling tower	>15 (13-17)	8	>23	8	11	>34	>85	>170
Dry air cooling	-	20	20	20	28	48	120	240

¹⁾ for calculation of correction factor see Annex II

3.2.3 Reduction of required energy for cooling

Reduction of required energy use of cooling systems is a matter of environmental balance. Again, integrated measures within the industrial process to reuse heat will decrease the need for discharge of excess heat into the environment. If a smaller cooling capacity is required, generally and in absolute terms less energy is needed to operate the cooling system. More efficient equipment and proper operation of the cooling system avoiding temperature increase on the process side can achieve any further reductions.

The right choice of material and design will reduce the required power consumption of cooling systems. This is a very complex matter including many factors, where general advice is difficult to give. The following practices are applied and can be mentioned, as options one should be aware of:

1. proper lay-out of the cooling system, such as smooth surfaces and as few changes of flow direction as possible, will avoid turbulence and reduce resistance to the flow of the coolant;
2. in mechanical cooling towers, choice of type and position of fans and possibility of airflow adjustment are options for reduced energy use;
3. choice of the right fill or packing (in light of the operating conditions) to secure maximum heat exchange at all times;
4. choice of drift eliminators with minimum resistance to airflow.

Changes in material and design do not seem to be cost-effective options to reduce energy requirements for existing systems, particularly for large systems. Replacing cooling tower internals (fans, fill and drift eliminators) are an option in some cases. For smaller systems, such as the open and closed recirculating wet cooling systems that are on the market as an off-the-peg product, a change of the cooling system is technically much easier.

A good example of design effect is the application of smooth (finned) supporting pillars at the inlet of a large (178 m.) natural draught cooling tower for a nuclear power station. The design enhanced the airflow and reduced the pressure drop enabling 0.3°C colder cooling, where 1°C cooler for this installation is approximately equal to a saving of EUR 250000/year.

Very little has been reported on the options for reducing the required amount of energy of a cooling tower through more energy efficient fans or by flexibility of operation system. In supplier's information, data can be found on the available fan types and the power needs. Fans are available that can be operated at variable speeds [tm97, Immell, 1996] or users are advised to apply a multifan system to have more flexibility in adjusting the required airflow.

With respect to the effect of drift eliminators on the performance of fans due to induced pressure drop, [tm092, Becker and Burdick, 1994]. Concluded that there will be differences between different eliminator designs and that the difference in effect on fan performance needs careful consideration, taking the full systems context into account. This means that a complex evaluation must be carried out involving tower configuration and flow distribution across the fan and across the drift eliminator. From this a useful comparison between different fan designs will be possible.

Examples of changing cooling tower fill reported considerable increases in efficiency of the heat exchange, lowering the temperature of the cooling water leaving the tower and achieving a better cooling ([tm034, Hobson et al., 1995], [tm041, Burger, 1994], [tm117, Remberg and Fehndrich, 1993]).

Improving the heat exchange capacity of the fill will improve the cooling of the process in the heat exchanger. Consequently, fan operation may be reduced whilst achieving the same level of cooling as before. With an unchanged level of operation, cooling capacity will be larger. Applying the wrong fill configuration can create unnecessary resistance to the air flowing past or through, but the tower geometry is also important. Dense film fill packs create larger air

pressure drops and usually require more fan energy. Splash fills have lower air side pressure drop, but due to its lower efficiency this fill requires larger towers or more cells, and compensation cannot be made with a higher energy input for fan operation.

Practical experiences report a clear effect of maintenance in reducing the required amount of energy to operate cooling systems. Generally, for water cooled systems this means proper systems treatment to reduce the resistance in the system due to scaling, corrosion, fouling etc. Systems treatment will keep the surface of the exchangers, conduits and packs in cooling towers smooth. It will prevent resistance to the water flow, reduce required pumping capacity and enhance the exchange of heat. Appropriate cooling water treatment (see Section 3.4), balancing the application of cooling water additive against a rise in process temperature, will reduce direct energy use as well as indirect energy use. No quantification of the reduction of kW_e per MW_{th} discharged due to improved maintenance has been reported.

3.3 Consumption and emission of cooling water

3.3.1 Consumption of water

3.3.1.1 Intake of water and water requirements

Water is an important medium for cooling systems and especially for large once-through systems, whereas for dry air-cooled systems it is of no importance. Surface water, groundwater and potable water are used. In principle salt water, brackish water and fresh water can be used for cooling purposes. Salt water is abundantly available at coastal locations, but the disadvantage of salt water is its corrosiveness. The use of groundwater for cooling purposes is expected to reduce in the coming years, because groundwater for low-grade use (such as cooling) will be increasingly less permitted, unless it is combined with indispensable groundwater extraction associated with other needs. Examples are the lowering of groundwater level for unhindered mine exploitation or water from pumping measures for hydropower. Less groundwater availability could result in an increase in the consumption of surface water for cooling.

Water use and water consumption are terms both used for the requirements of cooling water systems. Water use means that the same volume of heated cooling water is directed back to the source from which it has been taken (once-through). Water consumption mean that only part of the water used for cooling (blowdown of recirculating systems) is directed back into receiving water, the remainder having disappeared by evaporation and drift during the process of cooling. Consumption is particularly important where groundwater is used for cooling purposes in drought sensitive areas.

The volume of water used is largely connected with the type of industry. Different sources show that the use of cooling water in Europe is considerable [Correia, 1995]. Generally, the largest share of (surface) water is required by power stations. The remainder is accounted for by a small number of larger industries, of which the chemical industry is the largest user.

The volume of water required varies between the various cooling water systems (Table 3.3). For once-through systems (direct and indirect) the use of water depends on:

- requirement of the process (condenser)
- the temperature of intake water
- the maximum allowed temperature increase of the receiving water
- maximum allowed temperature of cooling water when it is discharged.

Table 3.3: Water requirement of the different cooling systems
[tm001, Bloemkolk, 1997]

Cooling system	Average water use [m ³ /h/MW _{th}]	Relative water use [%] ¹
Once-through system –direct	86	100
Once-through system –indirect	86	100
Open wet cooling tower –direct	2	2.3
Open wet cooling tower –indirect	2	2.3
Open wet/dry (hybrid) cooling tower	0.5	0.6
Closed circuit wet cooling tower	variable	Variable
Closed circuit dry air cooling tower	0	0
Closed circuit wet/dry cooling tower	1.5	1.7
¹) assumption: cooling capacity ΔT 10 K open wet cooling tower: cycles of concentration between 2 and 4 open wet/dry cooling: 75% dry operation closed circuit wet/dry tower dry operation ranging from 0 to 25 %		

In open recirculating systems, closed circuit wet and closed circuit wet/dry cooling towers, most of the water is recycled and the heat is dispersed to the atmosphere mainly by evaporation. In these systems water use varies considerably and no specific data are available as performance depends on the concentration factor applied (regulated by the intentional blowdown), evaporation and to a lesser extent to the ambient temperature.

Indirect closed circuit dry cooling towers can use water as secondary coolant but the use is very low compared to that of water cooling systems. Normally, replenishment or make-up water is only needed when leakage has occurred, e.g. at pump packages, flanges and valves, or when water has been drained to allow systems repair. In those circumstances amounts are small and potable water or even demineralised water can be economically used.

Legislation

In Member States different authorities deal with water as a resource or as a receiving environment. In any case water use should be part of an integrated environmental permit, especially where supplies are limited. It is expected that throughout Europe the pressure on resources of good quality water will increase the pressure on water conservation measures in cooling systems, limiting volumes allowed to be extracted from a source. With respect to water use the major legislation on European level is the Water Framework Directive. It focuses on both the water quality and on the quantitative groundwater status defined in terms of the effect of the ground water level on associated surface ecosystems and in terms of sustainability of the water supply. On a national level some Member States have separate legislation for aspects concerning the intake and use of surface water.

Cross-media issues

The issue of restricting the use of water relates to the following environmental aspects:

- heat emission to the surface water,
- application of cooling water additives,
- energy consumption of both cooling system and production process,
- indirect emissions.

Each of these factors needs to be assessed to evaluate whether reduced water intake for cooling is the best solution. In the following paragraphs an attempt is made to describe applied reduction techniques options and their cross-media effects.

3.3.1.2 Applied techniques to reduce water consumption

Reduction of water consumption for cooling is of particular interest where water availability is low for natural or ecological reasons. This can be drought-stricken areas or areas with seasonal low rainfall. The danger of depletion of groundwater sources and situations with relatively large cooling water requirements, where demands approach or could exceed the river flow or where heat emissions into the surface water are restricted, are other typical examples.

1. Cooling technology

In reducing the amount of water required for cooling, systems choice is important. In a greenfield situation it is suggested that air cooling be considered e.g. by applying open cooling towers. For large systems the required cooling capacity could limit the options for dry air cooling, as it requires a large heat exchange surface. If it is feasible, attention should be paid to the change in overall efficiency, increased operation costs for fan operation and costs of noise abatement. Applications of dry cooling systems generally lead to a decrease of the process efficiency. Consequently, wet systems are to be preferred. Only in the case that no supply with water (resp. make-up water) is possible dry cooling is unavoidable.

For existing once-through systems the application of recirculating systems (open wet cooling towers) is an applied option to reduce water requirements. Towers are equipped with drift eliminators as a standard technique to further reduce water loss through evaporation. Generally, recirculation means that measures need to be taken to protect the heat-exchanging surface against scaling or corrosion. On the other hand, application of recirculation of cooling water at the same time means a reduction of heat emission to the surface water.

2. Systems operation

In recirculating wet cooling systems a commonly applied operation is the increase of the concentration factor by reducing the frequency of the blowdown. The cleaner the water the easier this is and proper maintenance of an open wet cooling tower will reduce the contamination of the cooling water and may enhance a higher number of cycles and consequently a less frequent blowdown.

Increasing the cycles of concentration generally leads to an increased demand for anti-fouling chemicals to allow for higher salt concentrations without the risk of deposition. A number of reports can be found that present water treatment programs designed in particular for operation with higher cycles of concentration to reduce water requirements and to reduce the volume of the blowdown [tm094, Alfano and Sherren, 1995]. Under permit conditions, attention should be given to the potential increase in concentrations of elements in the blowdown.

A critical review of the results of maximising cooling tower cycles and the problems encountered can be found in [tm095, Cunningham, 1995]. The conclusion is that the ability to increase the number of cycles depends on many chemical and physical factors (e.g. water temperature, pH, water velocity) and requires a high level of expertise. Given the variety of operating conditions and water chemistry, it may not be easy to predict the maximum cycles of concentration and care must be taken to consider the costs involved before the cooling system can be operated economically.

3. Additional techniques

For recirculating systems, using relatively limited amounts of water, a number of additional techniques have been applied. These techniques aim at improving cooling water quality.

Pre-treatment of cooling water (such as flocculation, precipitation, filtration or membrane technology) can reduce the water requirements, where less blowdown is required to maintain the same concentration factor. Water treatments however will lead to sludge that will have to be disposed of (see Annex IV on blowdown).

The evaporative pond is a technique still applied on some older sites and is undergoing further development. It can be applied to prevent heat emissions to the surface water precooling the cooling water before discharge, but could serve in a similar way as a cooling tower being part of the total circulation. In the evaporative pond water is cooled down by spraying it over a large

catchment area, creating large cooling surface, after which it can be reused (Annex XI). Attention should be paid to the microbiological risks due to the formation of aerosols (see 3.7.3).

Reducing the demand on water resources is also attempted by linking the water flows of different industrial units on one or more sites. This water conservation method can be quite successful but needs careful consideration. In an evaluation of alternatives for water conservation for industrial sites, a number of important considerations are listed [tm065, Meier and Fulks, 1990] that should be taken into account:

1. survey of available water resources and their chemistry;
2. assessment of quantities of these sources and their fluctuation;
3. assessment of the contaminants and treatments in water sources;
4. the effect of current water resource treatment programmes on the existing cooling water conditioning methods;
5. effect of potential conductivity increases of recycled water on the process where the water is used;
6. chemical treatment programme options for the cooling systems;
7. economics of alternative reuse methods.

The factors listed above affect the selection of water sources and the amount of water that can be reused. Water resources on site are typically blowdowns from cooling towers and boilers. Tertiary treated municipal waste plant effluent is also used. It is important in all cases to avoid an increased need for an even more complex water treatment programme to enable water reuse (Annex XI). Reuse of the blowdown of evaporative ponds is also possible in applications that are not sensitive to the increased salt content of the water.

The zero discharge system based technology can be applied by treating and reusing the blowdown. Disposal costs of the resulting sludge need to be assessed against the environmental costs of conditioning and discharging of blowdown (Annex XI).

3.3.2 Fish entrainment

3.3.2.1 Level of entrainment

With a large water intake, such as for once-through cooling water systems, the impingement and entrainment of fish is an issue. Entrained fish - mainly fish larvae passing through the sieves at the cooling water intake, the pumps and the condensers - are not generally sampled. Entrainment is a local matter and the quantity of entrained fish is based on a complex of technical and hydrobiological factors that lead to a site-specific solution. Water is drawn into inlet channels in large quantities and at considerable speed. The inlet channels are generally equipped with debris filters to protect the heat exchangers against clogging and mechanical damage. Impingement occurs when fish are pressed against the sieves placed the condensers or heat exchangers. A lot of smaller creatures is taken in with the cooling water and is killed by mechanical damage, which is called entrainment.

Data on the amounts of fish taken in with the cooling water or caught at the entrance of a cooling system have not been widely reported. Results of 24-hour-samples have been analysed on the number of fish impinged by the cooling water of a 600 MW_e Netherlands power plant [KEMA, 1992] on the river Rhine, with a cooling waterflow of 22 – 25 m³/s. The results show that the numbers of fish drawn in between years as well as between seasons of the same year vary widely. Most fish were found in summer.

Studies at a 2000 MW inland power plant on the River Trent in England showed that by far the majority of entrainment occurred at or soon after dusk, and in the summer. The power plant

does not have a once-through cooling system, and no evidence was found of significant impingement. This was also the case at another similar sized power plant on the River Thames [Carter and Reader, in press]. The screens at both plants have approximately 9 mm mesh width. Research on entrained and impinged fish at nine Dutch power plants shows that more than 95% of the impinged fish were 0⁺-fish, born in the spring of the same year and with a length of less than 10 cm. This is confirmed by results in the above-mentioned power plant on the River Trent, although mortality was 100% while there was negligible fish mortality compared with observed natural death [Carter and Reader, in press].

There is also variation in the number of entrained fish and in entrained fish species between different power plants. The results of a sampling programme at six Dutch power plants on the river Rhine, the river Meuse and branches of these rivers show a variation in entrained species between 12 and 25 species and a variation in impinged fish on the cooling water sieves between 0.02 and 2.45 fish per 1000 m³ cooling water averaged over the year [Haddingh et al., 1983]. At power plants on lakes, on estuaries and on the sea coast the observed number of impinged fish can be much higher than at power plants on rivers, up to 25 fish per 1000 m³ [KEMA, 1982].

Table 3.4: Fish impingement rates (FIR) at power stations. Annual catches normalised to the cooling water flow [tm164, Travade, 1987] and [tm165, Turnpenny et al, 1985]

Water	Power Station	Power (MW _e)	FIR (kg/10 ⁶ m ³)
North Sea	Sizewell A	480	73
	Kingsnorth	2000	4.4
	Dunkerque	600	19
	Gravelines	5400	48
English Channel	Dungeness A	410	190
	Dungeness B	1200	40
	Paluel	5200	43
	Fawley	2000	19
Bristol Channel	Hinkley B	1300	24
Estuaries	Le blayais	3600	79
Rivers	Loire (St Laurent A)	1000	1.8

3.3.2.2 Applied reduction techniques

With varying results a number of techniques has been developed and applied in industry to prevent the intake of fish due to large cooling water intake. The optimum solutions and results and the ability to meet BAT requirements are influenced by a wide variety of biological, environmental and engineering factors that must be evaluated on a site-specific basis. A comparison of the different techniques is therefore impossible.

1. Cooling technology

Technology changes made to avoid fish entrainment have not been reported. It is obvious that fish entrainment will not be an issue when changing to open or closed recirculating cooling systems, which is a costly operation. It may be considered in a greenfield situation. Devices to prevent intake of fish can be found in e.g. power industry and refineries. Solutions for prevention are:

- sound devices, positive to divert (a shoal of) scale fish but not for eel;
- light systems with underwater lamps, positive to divert eel;
- position, depth and design of the inlet;

- limits to speed of the water inflow (although the data from studies carried out in England indicate that the entrained fish allow themselves to be carried by the flow (i.e. deliberately drifting or dispersing) even when they are physically capable of escaping the flow by swimming);
- mesh size of the cooling water sieves (against damage to the cooling system). Observations have shown that, in the same power plant, a mesh size of 5 x 5 mm on average doubles the number of surviving entrained fish at the cooling water outlet compared with a mesh size of 2 x 2 mm, because impingement mortality of fish larvea is higher than entrainment mortality [KEMA, 1972] and [Hadderigh, 1978].

Mortality of impinged fish can be decreased by a good system to wash the fish from the cooling water sieves and to sluice them back to the surface water.

2. Operating practice and end-of-pipe techniques

Lowering the inflow velocity to below 0.1-0.3 m/s clearly showed a positive effect and reduced the amount of fish drawn in. However, lowering the velocity may mean that larger inlet channels are required, which may have technical and financial consequences. In general, changes in operating practice or the application end-of-pipe techniques do not apply to fish entrainment, but there is also a view –not shared by all- that entrainment could be reduced by taking account of the diurnal and seasonal patterns of entrainment.

Table 3.5: Available fish protection technologies for cooling water intake devices

Derived from [tm152, Taft, 1999]

Category	Protection technique	Effects	Remarks
Fish collection systems	Optimizing (increasing) the mesh-size of the travelling water screens	Improve survival of entrained fish larvae and very young fish stadia	Entrainment mortality of these fish stadia is lower than the impingement mortality of these stadia.
	Low pressure water jets to wash off the fish from the travelling screens and to return them to the surface water	Transport of fish back to the surface water	Requires a second high pressure jet system to clean the travelling screens
	Fish buckets on the screens	Improve survival of impinged fish	The fish remain in water permanently during transport back to the surface water
	Continuous rotation of the travelling screens	Improve survival of impinged fish	Reduction of impingement time
	Fish pumps	Transport of fish back to the surface water	Complicated to keep right conditions in pipes
Fish diversion systems	Angled screens or louvres with a fish by-pass	<ul style="list-style-type: none"> - Survival harder species (50-100%) > fragile species - Not for fish eggs, larvae and small invertebrates 	<ul style="list-style-type: none"> - Requires uniform, constant low-velocity flow - Debris must be removed
Behavioural barriers	Lights <ul style="list-style-type: none"> - strobe lights - continuous lights - mercury lights - other lights 	Effects of different light systems depend on local situation, fish species and developmental stadia of the fish.	In many situations a by-pass for diverted fish is necessary
	Sound	Effects depend on local situation, fish species and developmental stadia of the fish.	In many situations a by-pass for diverted fish is necessary

3.3.2.3 Costs of sound devices and light systems

It is obvious that any change made to an existing system will be costly. The power industry reported additional costs for fish protection technology applied to existing installations of between EUR 40000 and 200000, including downtime costs. In greenfield situations the additional investment of alternative intake devices would probably be less substantial.

For a good efficacy the water current through sound devices and light systems must not be higher than 0.3 – 0.5 m/s. This determines the length of the systems.

The material and construction costs of a light system are EUR 90000 – 140000 for a length of 100 m and of a sound system (BAFF) about EUR 180000 per 100 m.

3.3.3 Heat emission to surface water

3.3.3.1 Levels of heat emission

All heat that is discharged will finally end up in the air. If water is used as the intermediate cooling medium, all heat will be transferred to the air, either from the water droplets in a cooling tower or from the surface of the receiving water. Before the heat has left the surface water it may affect the aquatic ecosystem and this should be avoided.

Heat emission is also an issue closely related to the amount of cooling water used and discharged. Once-through systems, both direct and indirect, by definition form the largest source of heat discharged to the surface water, as the heat is entirely discharged via the cooling water. The cooling water in recirculating systems releases the majority of its heat via a cooling tower into the air. The amount of heat discharged with the drainage from a cooling tower amounts to approximately 1.5% of the heat to be discharged, whereas around 98.5% is released into the air. There is little information on the effects on the aquatic ecosystem of heat emissions, but there are experiences with high summer temperatures and small receiving waterways. Temperature rise may lead to increased rates of respiration and of biological production (eutrophication). The discharge of cooling water into the surface water influences the total aquatic environment, especially fish. The temperature has a direct effect on all life forms and their physiology and an indirect effect by affecting the oxygen balance.

Warming reduces the saturation value of oxygen; with high oxygen concentration, that leads to a reduced oxygen level. Warming also accelerates the microbial degradation of organic substances, causing increased oxygen consumption. Also, where circulation of the cooling water occurs or where a number of industries use the same limited source of surface water, heat emissions need careful consideration to prevent interference with the operation of industrial processes downstream.

From the specific heat of water amounting to approximately 4.2 kJ/kg/K the temperature rise of water can be calculated. For example, when cooling water is warmed up by an average of 10K, 1 MW_{th} of heat requires a cooling water flow of about 86 m³/hour. Broadly speaking each kW_{th} needs 0.1 m³/hour of cooling water. With recirculating cooling water, heat is transferred to the air through evaporation via cooling water in a cooling tower with the evaporation heat of water being 2500 kJ/kg (at 20°C).

In the power industry in particular, the factors playing a role in the discharge of large quantities of heat into the surface water have been researched. A number of physical phenomena have to be taken into account when heat emissions are being assessed, such as:

- seasonal variation in the temperature of the receiving water;
- seasonal variation in the water level of rivers and the variation in the velocity of the stream;
- the extent of mixing of the discharged cooling water with the receiving water (near field and far field);
- at coastal sites, tidal movements or strong currents and
- convection in the water and to the air.

The behaviour of the hot water plume in the surface water will not only be valuable in protecting the receiving environment, but also for choosing the right place for the inlet and outlet. It will always be important to prevent circulation of the plume affecting the temperature of the water taken in and consequently the efficiency of the cooling system. As an example, the extent of a thermal plume, defined as the area within the 1K heating isotherm, without mixing with strong currents (e.g in a lake), is about 1 ha per MW_e for a conventional power plant, or about 45 km² for a 5000 MW_e power plant. For a more extensive description on heat plume behaviour see Annex XII.

3.3.3.2 Legislative requirements of heat emissions

Requirements for specific fresh water bodies

European Directive 78/659/EEC (18 July 1978) sets environmental quality standards for certain substances and for heat discharges in designated freshwater fisheries. The directive acknowledges local conditions in a provision in Article 11 regarding derogation for Member States.

Where thermal requirements depend on the fish species, two types of water bodies are distinguished, according to their fish population:

- salmonid waters
- cyprinid waters.

For each ecological system, three thermal parameters are applied:

- maximum water temperature at the boundary of the mixing zone
- maximum temperature during the breeding period of “cold water species”
- maximum temperature rise.

Table 3.6: Thermal requirements of water temperatures for two ecological systems (European Directive 78/659/EEC)

Parameter	Salmonid waters	Cyprinid waters
T _{max} at boundary of mixing zone (°C)	21.5	28.0
T _{max} during breeding period cold water species (°C)	10.0	10.0
ΔT _{max} (°C) at boundary of mixing zone	1.5	3.0

Note: temperature limits may be exceeded for 2% of the time at maximum.

Other receiving water bodies

In the Member States, heat emission to the surface water is regulated in various ways, depending on the ecological conditions and other factors such as: the sensitivity of the receiving surface water; the local climatic conditions; the capacity of the receiver to accommodate thermal loads and the prevailing currents and waves (water hydrodynamics). Regulations often consider heat emissions in relation to the receiving surface water. Examples are:

- standardisation of the maximum discharge temperature (e.g 30°C in summer in temperate climates and 35°C in hot countries),
- limiting maximum heating in relation to the water received and to seasonal temperature differences (e.g. ΔT_{max} of 7-10K measured over the entire cooling water distance in the production process)
- setting maximum acceptable temperature profile of the surface water and the total available cooling capacity of the surface water.

These requirements are formulated in permits.

Other regulations do not prescribe a generally fixed discharge temperature. Initially the limit discharge temperature corresponds with the type of cooling system. Additionally, seasonal variation of the temperature of the surface water plays an important role in setting the discharge temperature to be permitted. Some regional authorities also further classify the receiving waters using characteristics of their fauna.

3.3.3.3 Applied reduction techniques

1. Cooling technology

The best way to minimise heat emissions is to reduce the need for discharge by optimising the primary process or to find consumers for the excess heat. In the case of emission of heat into the environment, focus is on the problem of heat emissions into surface waters. In considering the reduction techniques it is important to realise that in the end all heat will disappear to the air and that the surface water is an intermediate medium. By choosing between different cooling systems, it can be decided which is preferable. Thus, the environmental impact of heat discharge can be minimised by discharging more heat into the atmosphere and less heat into surface waters at the expense of water loss due to evaporation. Minimisation of heat discharges to the surface water is linked to the minimisation of water use and to the overall energy efficiency. The more heat is discharged by convection and evaporation, the more E per discharged MW_{th} is required due to use of fans, unless natural draught is applied. This generally needs large investments and a lot of space.

In the case of large capacities, a widely practised solution to reduce the heat load to the surface water of (mainly) rivers and lakes is to choose a suitable heat transfer technology, e.g. instead of a once-through system a recirculating system with an open wet or wet/dry cooling tower.

2. Operating practice

No particular operational options have been reported to prevent or reduce the discharge of heat to the surface water.

3. Additional techniques

An old practice still in use in Europe, but on a very small scale and recently attracting fresh attention, is the use of evaporative (spray) ponds. To enhance cooling of the water, the angle of the nozzle and the time allowed for the water to remain in the pond before it re-enters the cooling circuit are important, as is sufficient surface area. To assess this technique it should be compared with a cooling tower of similar capacity. Attention should be paid to:

- surface area needed,
- loss of water due to evaporation
- energy use
- the need for water treatment, as well as
- to microbiological risks due to formation of aerosols (see also 3.7.3).

Another kind of end-of-pipe technique is the precooling of the discharge of large power plants by means of a cooling tower. It is a costly technique used where circulation of the discharge in the surface water can influence the cooling water temperature at the point of inlet. The additional costs of the extra cooling tower plus the loss of water due to evaporation will have to be compared with the costs related to a reduced efficiency with a higher temperature of the intake water.

A measure also suggested to reduce the effect of heat discharge is designing the water outlet of the cooling system in such a way that by turbulence the water will lose some heat during discharge. A side effect of this measure is an increase of the oxygen content of the cooling water compensating for the loss of oxygen due to the higher cooling water temperatures. No data are available and the extent of the effect is also questioned.

3.4 Emissions from cooling water treatment

Emissions from cooling water treatment into the surface water are regarded as one of the most important cooling systems issues. Four sources of emissions to the surface water resulting from wet cooling systems can be distinguished:

- process chemicals (product) and their reactants, due to leakage;
- corrosion products due to corrosion of the cooling system equipment;
- applied cooling water additives and their reactants;
- airborne substances.

To control these emissions different techniques are applied. The risk of leakage can be reduced as well as the possibility of uncontrolled emissions after leakage and the most adequate material for the equipment can be selected to reduce corrosion. This section will focus on measures to reduce the amount and the impact of emissions due to the application of cooling water additives:

- by reducing the need for water treatment;
- by selecting chemical treatments which have lower impact on the environment;
- by applying the chemicals in the most effective way (systems operation).

3.4.1 Application of cooling water treatment

Cooling water is treated to promote an efficient transfer of heat and to protect the cooling system so as to overcome a number of adverse effects on the performance of the cooling equipment. In other words, cooling water treatment aims to reduce total energy consumption.

The adverse effects are strongly related to the chemistry of the water taken in for cooling and the way the cooling system is operated (e.g. cycles of concentration). Salt water will have different demands from fresh water and industrial emissions of polluted substances upstream may be a challenge. Also, cooling water can become contaminated by leakage of process fluids from heat exchangers or, in the case of wet open cooling towers, by the air passing through the tower introducing dust, micro-organisms and exchange of vapour.

Cooling water additives are used for once-through systems, open wet cooling systems, closed circuit wet cooling and wet/dry systems. Where water is used as an intermediate coolant in the coil of dry systems, very low amounts of additives may be used to condition the water in the closed loop.

Environmentally, additives are important: they leave the cooling system at some stage, being discharged to surface water or, to a much lesser extent, into air. Generally, the chemistry and the application of the chemicals applied are known, but the choice of non-oxidizing biocides is mainly based on “trial and error”. The environmental effects of the chemicals used can be assessed by means of modelling (risk/hazard) or by measurement. As they are used to improve an efficient heat exchange, their application is also related to the adverse effects that arise from a lower exchange efficiency. The industrial process to be cooled can be affected when heat transfer is inefficient, causing an increase in the use of energy (i.e. similar to an increase in air emissions) or a higher demand on raw materials to compensate for the loss of production. Energy consumption of the cooling system can increase due to a higher demand on pumps and fans to compensate for loss of heat exchange efficiency.

Problems arising from water quality that are commonly encountered are:

- Corrosion of cooling water equipment, which may lead to leakage of heat exchangers and spills of process fluids into the environment or loss of vacuum in condensers;
- Scaling, predominantly by precipitation of calcium carbonates, sulphates and phosphates, Zn and Mg;

- (Bio-)Fouling of conduits and heat exchangers (also fill of wet cooling towers) by micro-, macro-organisms and suspended solids which can lead to blockage of the heat exchanger tubes by large particulate (shells) or to emissions to air from cooling towers.

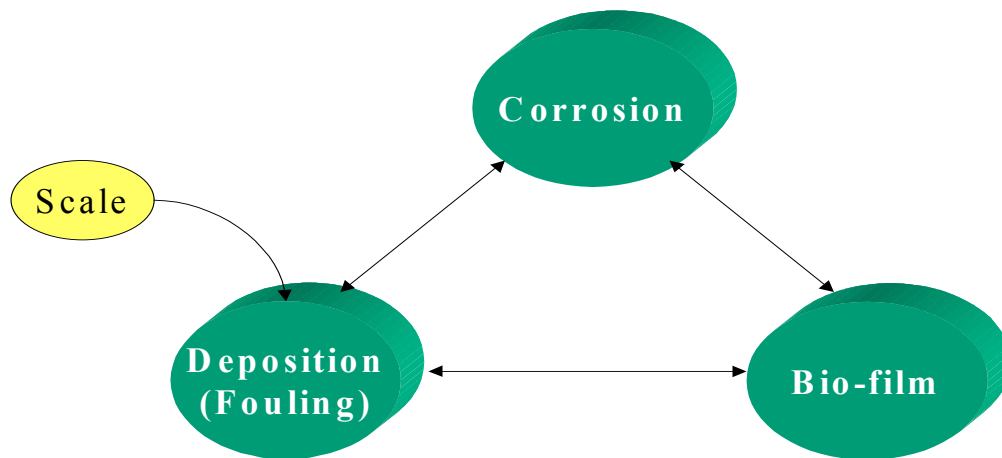

Figure 3.1: Graphic representation of interrelation between the different water quality problems

Cooling water problems are often interrelated. Scaling can lead to both corrosion and biofouling. Spots of corrosion lead to changed waterflow patterns and create turbulence areas, where biofouling is enhanced. Biofouling may enhance further corrosion of the underlying surface (Figure 3.1).

The following groups of chemicals are used to condition the water (see also Annex V):

- Corrosion inhibitors:
formerly metals were mainly used, but there is a trend towards azoles, phosphonates, polyphosphates and polymers. This means that toxicity decreases while the persistency increases. Recently some better biodegradable polymers have been developed.
- hardness stabilisers or scale inhibitors:
formulas exist mainly of polyphosphates, phosphonates and certain polymers. Recent developments in this application are also towards better biodegradable compounds
- Dispersion chemicals:
mostly copolymers, often in combination with surfactants. The main environmental effect is poor biodegradability.
- Oxidising biocides:
chlorine (or a combination of chlorine and bromine) and monochloramine are mainly used. Chlorine (bromine) is a strong oxidiser (acutely toxic), which means that the half-life is short, but the side effects of chlorinating are the forming of halogenated by-products. Other oxidising biocides are ozone, UV, hydrogen peroxide or peracetic acid. The use of ozone and UV needs pre-treatment of the make-up water and needs special materials. The environmental effects are expected to be less harmful than halogenated biocides, but the application needs special care, is expensive and not applicable in all situations.
- Non-oxidising biocides:
isothiazolones, DBNPA, glutaraldehyde and quaternary ammonium compounds etc. These compounds are in general acutely toxic and often not readily biodegradable, although there are some which hydrolyse or are degraded by other mechanisms. The environmental effects are significant.

Table 3.7: Chemical components of cooling water treatments used in open and recirculating wet cooling systems
 Derived from [tm135, Nalco, 1988]

Examples of chemical treatment*	Water quality problems					
	Corrosion		Scaling		(Bio-)fouling	
	Once-through systems	Recirculating systems	Once-through systems	Recirculating systems	Once-through systems	Recirculating systems
Zinc		X				
Molybdates		X				
Silicates		X				
Phosphonates		X		X		
Polyphosphates		X		X		
Polyol esters				X		
Natural organics				X		
Polymers	X	X	X	X	X	X
Non-oxidizing biocides						X
Oxidizing biocides					X	X
Notes: chromate is not widely used any more due its high environmental effect						

The need for cooling water treatment and type and amount of chemicals applied are more extensively described in Annex V. The application of cooling water conditioning is a highly complex and local issue, where selection is based on a combination of the following elements:

- design and material of heat exchanger equipment;
- temperature and chemistry of the cooling water;
- organisms in the surface water that can be entrained;
- sensitivity of the receiving aquatic ecosystem to emitted additive and its associated by-products.

For proper performance of any of the treatments, control of the cooling water pH and alkalinity within a specified range is usually required. Good pH and alkalinity control has become more important where more pH-sensitive treatment programmes are used or where higher cycles of concentration are applied in open recirculating cooling towers to minimise blowdown and reduce the water requirement. It is increasingly common practice in industry to have maintenance programmes developed and carried out by the additive supplier, but the responsibility for systems operation remains with the owner of the cooling system.

Considering the site and system specificity, it will be difficult to find typical levels of amounts of additives applied to the different systems. If levels are reported they are expressed in kg or tonnes per m³ of cooling water or in kg or tonnes per MW_{th} dissipated. Table 3.8 reports the result of a recent inventory in The Netherlands of chlorine, which is widely used in Dutch industry. Data show there is variation between systems as well as between different types of water. Other sources of water used by recirculating systems are for instance potable water, groundwater and condensate.

Table 3.8: Consumption of hypochlorite in wet cooling systems in The Netherlands [tm160, Bijstra, 1999]

Cooling water source	Consumption of active chlorine kg/MW _{th} /yr	
	Once-through systems	Recirculating systems
Fresh water	85 (10-155)	200 (20-850)
Salt or brackish water	400 (25-2500)	
Other water sources		400 (20-1825)

3.4.2 Emissions of chemicals into the surface water

In Europe and U.S. a large amount of work has been carried out on optimisation of cooling water conditioning, on the application of alternative treatments and on other techniques to prevent any harmful effects on the aquatic environment due to cooling water additives. By large, this work focuses on the application of biocides.

Specific emissions resulting from cooling water treatment can be difficult to assess in situations where analysis methods for the chemicals used for treatment are not available. Besides the specific chemicals used for treatment of cooling water, by-products originating from the chemicals used can also contribute significantly to the environmental impact on the surface water. When chlorine or bromine is used as an additive, 3-5% of the product reacts to haloform compounds (chloroform or bromoform) [tm072, Berbee, 1997].

Quantification of short-term effects can be achieved by carrying out (acute) toxicity tests on cooling water streams discharged. These results can be seen as a minimum estimate of the environmental effects in the surface water, [because long term (chronic) effects, biodegradability, bioaccumulation (P_{ow}) and carcinogenic effects are not included in these tests]. Recently several studies concerning the use of oxidising biocides (mainly hypochlorite) ([tm001, Bloemkolk, 1997],[tm072, Berbee, 1997] and [tm160, Bijstra, 1999]) and non-oxidizing biocides ([tm001, Bloemkolk, 1997] and [tm149, Baltus et al., 1999]) have been carried out in the Netherlands.

3.4.2.1 Oxidising biocides

In several countries programmes have been set up to achieve optimum use of hypochlorite in cooling water. Free oxidant [mg FO/l] is often used as a control parameter in cooling water. In The Netherlands a concentration of 0.1 – 0.2 [mg FO/l] in the discharge is used as a target concentration for continuous dosed (once-through) cooling systems. For intermittent or shock chlorination regimes the FO or FRO concentration is always below 0.2 mg/l as a daily (24h) average value. But during shock injection the FO or FRO concentrations can be close or equal to 0.5 mg/l (hourly average).

Optimisation by implementation of monitoring and controlled (automatic) dosage of biocides can significantly reduce the annual consumption of chemicals used in cooling water. This can result in a reduction of the load of biocides and of their by-products, such as organohalogenated compounds with bromoform as the main product [tm157, Jenner et al, 1998].

Several companies in the chemical industry and energy production sector have achieved reductions of the use of hypochlorite in cooling water up to 50 % by introducing the above-mentioned optimisation measures [tm160, Bijstra, 1999].

3.4.2.2 Non-oxidising biocides

In 1999 a study was carried out of the environmental effects of the use of oxidising and non-oxidising chemicals in recirculating cooling systems. For the chemicals for which analysis methods were available, concentrations of the chemicals in cooling water were measured. For all chemicals applied, toxicity tests were used to evaluate the environmental impact in the surface water. When cooling water is discharged directly into the surface water the use of non oxidising chemicals in recirculating cooling systems in many cases resulted in strong environmental effects in the surface water. For oxidising chemicals (hypochlorite), PEC/PNEC ratios based on toxicity tests were found in the range of 3 (continuous dosage) and 33 (shock dosage) and for non-oxidising chemicals, PEC/PNEC ratios of 20 (isothiazolines), 2500 (BNS), 660-13000 (BNS/MBT) and 3700(DBNPA) were found ([tm149, Baltus et al., 1999] see pag summary pag. 9-10, table 16 p. 64 and chapter 9 p. 75-82)).

Another study carried out indicated that potential risks for the receiving surface water cannot be excluded when isothiazolines (1,2-benzisothiazolin-3-on, 2-methyl-4-isothiazolin-3-on) are used in cooling water as additives (see[tm149, Baltus et al., 1999] pag. 13 en 14).

The treatment programmes vary considerably and depend on the factors mentioned earlier and as such are site-specific. Emissions of additives vary in volume and chemistry (toxicity, reactivity). Decomposition, interaction and possible purification measures can influence the actual amount that is finally discharged and, consequently, the resulting impact on the aquatic environment. Optimisation and controlled conditioning of cooling water by the use of (automatic) dosage and monitoring can reduce the use of chemicals in cooling water and consequently the environmental impact in the receiving water significantly.

In the Netherlands the application of hypochlorite and bromine in cooling water is one of the most important sources of organohalogenated compounds, measured as AOX, in surface water [tm001, Bloemkolk, 1997] and [tm072, Berbee, 1997].

Sometimes cooling water is treated in a wastewater treatment installation before discharge. An example is the treatment of the blowdown with other wastewater streams in refineries. This treatment could possibly reduce the effect of biocides in the surface water. Biological treatment may be sensitive to low levels of non-oxidising biocides, which could disturb the working of the treatment plant. Inhibition of active sludge of 60% and more (100%) has been reported. Physical/chemical treatment for biocides is still on an experimental level. The polarity of non-oxidative biocides will be an obstacle for physical treatment, as they will remain in the water phase.

The blowdown of open recirculating systems is the more controlled pathway in which biocides enter the external environment. For closed systems blowdown is not practised. Purges are made, but they are small and usually discharged into a sewer system. It is obvious that the concentration of biocides in the cooling water immediately after dosage will be highest and consequently the concentration in the discharge or purge. By chemical reactions in the systems' cooling water, such as hydrolysis, the biocide concentration will gradually diminish and this knowledge can be used to estimate the expected concentration in the discharge. This information is also used when closing the purge after treatment to prevent discharge of biocides with a high level of chemical activity. To achieve further optimisation several factors are important. Besides the concentration in the outlet, process control is also essential here.

3.4.2.3 Factors influencing emissions of biocides

Factors influencing discharge and persistence in the receiving aquatic environment have been extensively described [tm004, Baltus and Berbee, 1996] for a number of commonly applied oxidising and non-oxidising biocides. The following factors, in combination with the cooling process conditions play a role in the selection of a cooling water treatment program:

- Hydraulic half-time (also used is system half-life);
- Hydrolysis;
- Biodegradation;
- Photolyses;
- Volatility.

The volume of the purge determines the hydraulic half time. The larger the purge the smaller the hydraulic half time and the shorter the retention time of the biocide. The hydraulic half time does not influence the working of oxidising biocides, because of their fast dissociation and working, but for non-oxidising biocides it will limit their functioning.

Hydrolysis of a non-oxidising biocide occurs at a certain pH and water-temperature. Generally, with increasing pH and/or increasing temperature, hydrolysis increases and the biocidal effect will decrease. Consequently, the lower temperature of the receiving water will further slow down the hydrolysis and will increase the persistence of non-oxidising biocides in the aquatic environment.

Biodegradation, photolysis and volatility do not play an important role in degradation of non-oxidising biocides. Photolysis can take place if the aquatic environment is exposed to sunlight.

Evaporation may play a role in the case of oxidising biocides (hypochlorite). Research can be quoted in which a so called stripping effect of cooling towers has been found to account for a loss of 10-15% of hypochlorite with each passage of the cooling tower. For hypochlorite the pH level affects its evaporation.

Biodegradation of biocides depends on the amount of organic and inorganic matter and on the biodegradability of the biocide itself. A large microbial population, increase of temperature and higher oxygen content of the cooling water or the receiving water, increases biodegradation. Surface water contains a lot of suspended organic matter to which biocides can absorb, resulting in accumulation in the sediment. Also, biocides can be reduced by organic material.

3.4.2.4 Emission levels

It is difficult to report representative levels of concentrations in cooling water emissions to the surface water. Quantification of emissions of substances in the discharge of cooling water has been attempted and models have been developed. However, because of site specificity, no generally applicable model can be reported taking account all aspects. Many assumptions have to be made and although they give an indication, discharges could easily be overestimated or underestimated. An example of a model for biocides in an open wet cooling tower is explained [tm004, Baltus and Berbee, 1996] in Annex IX.

3.4.2.5 Legislation

In many Member States emissions of cooling water chemicals are covered by legislation on the pollution of surface waters. The laws usually focus on discharge flows with a minimum volume discharged (in m³/day). In some legislation (e.g. Italy) receiving waters are classified and each water has a different level for the relevant emission parameters of the discharged water.

The quality of the discharged water required sets limits on the presence of certain chemicals (e.g. chromium, zinc or mercury compounds), thereby reducing the use of particular cooling water additives.

For large and small discharge volumes, requirements are set for temperature and pH-values. The temperature is generally not allowed to exceed a maximum temperature for most of the year. Some flexibility is given by varying the discharge temperature limits under unfavourable seasonal conditions, such as wet bulb temperatures reaching up to 40°C in Mediterranean climate.

More specific requirements on the chemical composition vary between the Member States, but generally cover requirements on the concentration of adsorbable organic halogens (AOX), dissolved oxygen, biological chemical demand (BOD), chemical oxygen demand (COD), chlorine substances and phosphorus compounds and the residual effect on luminescent bacteria. Some acts distinguish between different types of cooling systems (once-through or recirculating) or consider specific operations, such as shock treatment with microbiocidal substances.

In the Netherlands the abatement efforts are based on the intrinsic properties of substances and risk assessments. To enable a company and the water authorities to unambiguously identify the water pollution effect of substances and preparations, a general evaluation methodology has been developed. This evaluation methodology is based on the European legislation on classification, packaging and labelling.

Depending on the properties of a substance BTM or BPM must be applied. After applying BTM/BPM the residual discharge is evaluated against the applicable water quality objectives. If these objectives are not reached, further measures may be indicated.

European chemical legislation affecting the application of cooling water additives in particular can be found in:

- the Council Directive on Pollution Caused by Certain Dangerous Substances Discharged into the Aquatic Environment of the Community (76/464/EEC),
- the Water Framework Directive,
- the Preparations Directive and
- the Biocidal Products Directive 98/8.

3.4.3 Reduction of emissions to the surface water

3.4.3.1 General approach

Techniques for the reduction of emissions to surface water due to the application of cooling water are:

1. reduction of corrosion of cooling equipment
2. reduction of leakage of process substances into the cooling circuit
3. application of alternative cooling water treatment
4. selection of less hazardous cooling water additives
5. optimised application of cooling water additives

Following IPPC, reduction of emissions due to cooling water treatment should aim at reducing the need for treatment (prevention) and at selection and optimal application of additives (pollution control) within the requirement of maximum heat exchange. To reduce the emission of chemicals in the discharge of cooling water, many options are available. In addition to the assessment of the appropriate cooling configuration explained in Chapter 1 and in accordance with the preventive “approach” of applying BAT to industrial cooling systems, the reduction options can be considered in a certain order. For new large capacity cooling systems, an “approach” has been developed to reduce emissions to the surface water [tm001, Bloemkolk, 1997].

An “approach” has been developed for the selection of biocides in both new and existing systems. [tm005, Van Donk and Jenner, 1996] . Both “approaches” involve more or less the same steps and following these steps will ensure that all important factors involved in the reduction of additive use are taken into account. The “approaches” are shown in Figure 3.2 and Figure 3.3.

For the optimisation of biocide use a wide range of possibilities exist, which are often interrelated. For setting up an optimisation scheme, a structured “approach” offers advantages. Recommendations are now presented by means of two flow charts, one for cooling water systems in the design phase and another for existing CWS. These charts offer a step-by-step “approach” for biocide optimisation.

Figure 3.2 is explained as follows [tm005, Van Donk and Jenner, 1996]. In the design phase of a cooling water system, a decision should be made on the type of cooling that is to be used. If water-cooling is used, engineering solutions that control the expected biofouling population in the CWS should be considered. Important issues to consider in the design phase are: maintenance of sufficiently high flow velocities in all parts of the cooling water system and a smooth design of conduits and heat exchangers. This will reduce settlement of biofouling organisms. The application of non-toxic foul-release coatings will help to further reduce the settlement of organisms. The intake structure should be designed such that entrainment of debris and organisms is minimised. Filtering devices and trash racks can further reduce the amount of entrained gross matter. The application of high integrity materials needs to be considered. For heat exchangers this can be titanium (corrosion resistant, smooth surface). Hydrodynamically designed inlet and outlet boxes of heat exchangers can be made out of glass reinforced plastics. This material can also be applied for tubing and joints in the system. Also, relatively simple provisions can be made in the design phase, such as connections for chemical and biological monitoring devices, or for dosing (e.g. special dosing racks and points) or more complex ones for mechanical cleaning, such as mussel sieves or a sponge rubber ball system. In some cases heat treatment can be used to control macrofouling, and then no biocide is needed at all. For the application of heat treatment a special loop in the CWS needs to be designed. Further possibilities for optimisation are similar to those in existing systems.

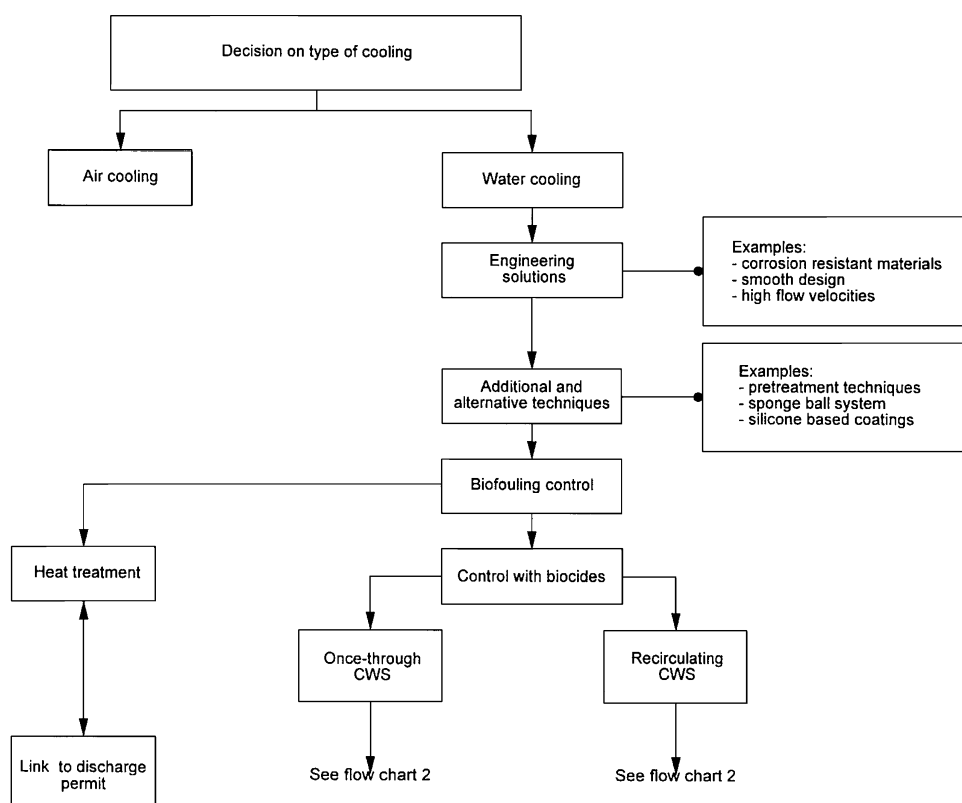

Figure 3.2: Design scheme for cooling water systems aiming at reduction of biocide application [tm005, Van Donk and Jenner, 1996]

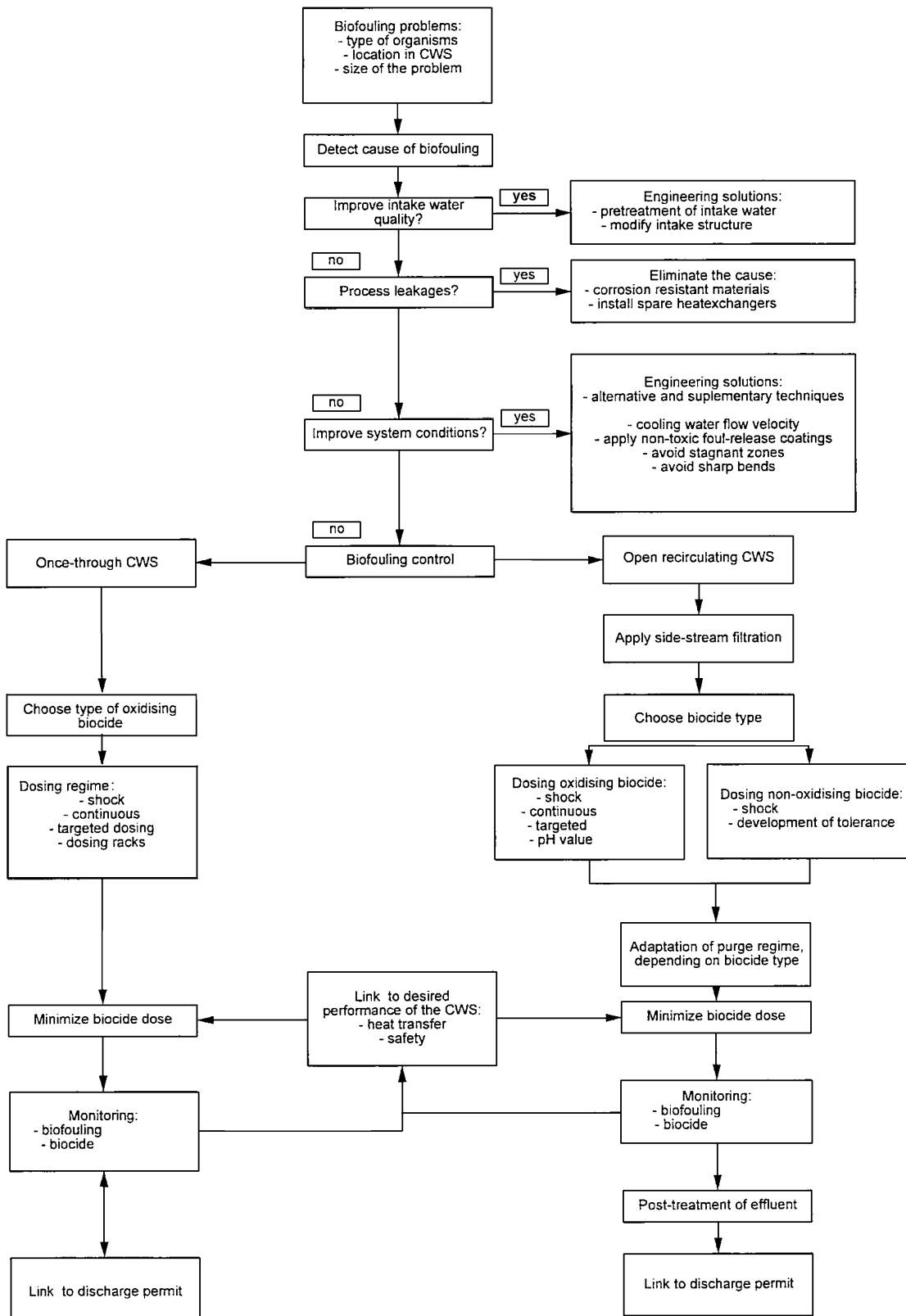

Figure 3.3: “approach” for reduction of biocide use in industrial cooling water systems [tm005, Van Donk and Jenner, 1996]

Figure 3.3 shows all the steps to be considered in the selection of biocides [tm005, Van Donk and Jenner, 1996]. In an existing CWS it is important to characterise the biofouling population and the size of the biofouling risk. Adequate biological monitoring is a prerequisite for this.

The cause of the biofouling problem should be analysed and addressed. The quality of the cooling water can be improved by pre-treatment of the water (e.g. micro- and macro-filtration). This can remove a part of the biofouling risk by reducing the amount of incoming organisms and nutrients. If process leakages are the main cause of increased biological growth, they should be eliminated, for instance by application of corrosion resistant materials or by installation of spare heat exchangers, which allows more frequent mechanical cleaning. In order to improve system conditions, all options mentioned in scheme 1 should be considered.

In once-through systems, macrofouling is sometimes controlled by the application of heat treatment, without any biocide use. Sodium hypochlorite is the most important biocide that is applied. Dosing is shock-wise or continuous. The dosing strategy on macrofouling control should be preventive, since curative dosing, when a lot of macrofouling has abundantly developed, requires very high doses over extended periods. It is recommended that consideration be given to the option of targeted dosage at locations with a high fouling risk, such as heat exchanger inlet and outlet boxes. Chemical monitoring is essential to establish the minimum required biocide dose. Since the applied oxidising biocide concentration will decrease in the CWS, chemical monitors are needed to register the effective residual level of biocide at the critical points in the CWS. On-line meters should be hand-calibrated with the colorimetric DPD test on a regular basis. Toxicity-based measurement of biocide concentrations in the cooling water is also useful for optimisation schemes. Macrofouling monitoring devices give information on the settlement and growth of macrofouling organisms and on the performance of the biofouling control program. This information is essential for biocide optimisation programs in once-through systems that have macrofouling problems.

In open recirculating systems, microfouling is much more important than macrofouling. Monitors of microfouling, such as the ATP method and the "plate count technique" give important information on the development and the state of the microfouling population in the CWS. To prevent entrainment of organisms and nutrients with the cooling water, the intake water can be pre-treated (e. g. microfiltration, precipitation). Side-stream filtration, the continuous filtration of a part of the recirculating water volume, further helps to reduce the amount of organic material in the cooling water. The amount of biocide required for successful treatment can thus be reduced. Side-stream filters should preferably be closed temporarily during shock dosing of biocide, which will avoid unnecessary biocide demand by the filter and avoid killing the microbial population on the filter.

In recirculating cooling water systems, oxidising and non-oxidising biocides are used. In the Netherlands approximately 90% of recirculating systems are treated with sodium hypochlorite. Non-oxidising biocides are only used when oxidising biocides cannot provide sufficient protection. For oxidising and non-oxidising biocides discontinuous or shot dosing is recommended to minimise their use, although in some cases continuous halogenation at low levels may consume less chemical than shot dosing. This will also reduce the risk of development of a tolerance of the biology. Accurate chemical analytical field methods for non-oxidising biocides are needed to optimise their use. The possibilities for hypochlorite measurement have been mentioned before. Biological methods for measurement of biocide concentrations in the cooling water may also be useful in recirculating systems.

If possible, it is recommended to close or reduce the purge during shock dosing of both oxidising and non-oxidising biocides, in order to reduce emissions of active biocide. This is especially effective for fast reacting or disintegrating biocides. It is further recommended to operate a recirculating CWS treated with hypochlorite at a pH value of 8-9, in order to minimise evaporation losses of HOCL over the cooling tower. Experience has shown that this does not

necessarily lead to reduced effectiveness of the biocide. It is important though to manage the risk of scaling.

The combined use of hypochlorite and bromide may be an attractive option in freshwater CWS, and also in once-through CWS, since some by-products - the brominated amines - have a stronger biocidal effect than their chlorinated homologues and they degrade more quickly.

In recirculating systems with a high water quality, ozone may be an option. It is important here to pay attention to the risk of corrosion. A few experiences in Europe have been successful with the application of ozone. Finally, UV-light may also offer possibilities in recirculating systems as a supplementary technique. UV-light alone however, cannot attack the biofouling that has settled on the surfaces of the CWS. In order to be effective, relatively clear cooling water is needed, since the light must be able to penetrate into the water column.

The “approach” can be summarised as follows:

1. The availability of water, amongst other factors, will decide on the selected cooling configuration (once-through, open or closed wet cooling tower or hybrid cooling tower). The configuration chosen may in turn affect the kind of water treatment. These generally differ between once-through and open wet cooling towers, such as the application of oxidising or non-oxidising biocides.
2. Once a system choice has been made (see also Chapter 1), a complex assessment scheme will have to be applied to match the numerous combinations between the following options which further affect the need for cooling water treatment:
 - choice of material and surface treatment of heat exchangers and conduits;
 - lay-out of the cooling system to avoid turbulence, sediments or mussel growth, or to enhance the required water velocity;
 - improve the cooling water chemistry by pre-treatment;
 - mechanical cleaning of the cooling system;
 - alternative treatments, such as thermal, UV and side stream filtration.

Depending on the result of this assessment a wet cooling system might still need a certain protection against scaling, corrosion or fouling. This depends on the chemistry of the cooling water, on the way the system is operated, such as the number of cycles of concentration, and the cooling configuration chosen.

It is clear that for closed circuit dry air-cooling or dry air-cooled condensers no such treatment is necessary. Chemicals might be used to clean the outside (finned) tubes, but usually not for operating the system.

Once the need for a cooling water treatment has been established, an accurate selection of the cooling water treatment program linked to legislative requirements is appropriate. These requirements can be:

- prohibition of the use of certain substances for cooling water treatment, e.g. chromium, mercury compounds, organometallic compounds, nitrites, mercaptobenzothiazoles;
- limitation of certain substances or groups of substances (e.g. zinc, phosphorus, chlorine, AOX) in the cooling water effluent by defining emission limit values;
- requirement of a minimum level of biodegradability for complexing agents;
- limitation of ecotoxicological effects of the cooling water effluent.

The selection of additives for cooling water treatment for both new and existing systems with the following “approach” will lead to a reduction in emissions of cooling water chemicals:

1. establish the need for cooling water treatment after other physical cleaning methods have been applied;
2. select the type of additives required;
3. assess the environmental risk of the substances to be applied;
4. apply substances which have lower potential for impact on the environment; where possible.

3.4.3.2 Reduction by selection of material and systems design

For new system's material and design options can be applied to reduce additive use. Many different materials are used for cooling systems equipment. Equipment suppliers usually offer their equipment in a wide range of different metals and alloys so as to enable the operator to select the material fit for the chemistry of the cooling water and process conditions it is intended for. Annex IV discusses materials for once-through and open recirculating systems using brackish or salt water. It is important to realize that some features of a material can have opposite characters, which may complicate material selection and will affect the cooling water treatment programme. For example, reduced corrosiveness may go together with a higher sensitivity to biofouling.

Proper layout and construction of a cooling system can influence the need for cooling water additives. During assemble, unnecessary ridges should be avoided as well as abrupt changes in the direction of the water flow. Both lead to turbulence and where possible this should be avoided as it enhances corrosion or settling of e.g. mussels.

Operating the system with the appropriate minimum water velocity not only maintains the required cooling capacity, but also reduces settlement of macrofouling and corrosion of material.

Coatings and paints are applied to reduce the fixation of the organisms, reinforce the velocity effect and facilitate cleaning. These antifouling paints can contain toxic substances and therefore non-toxic coatings and paints have been developed. Applicability underwater and price vary and depend on the size of the cooling system and conditions. E.g. organic coatings are applied to relatively smaller cooling units by means of thermal curing of the surface. These are powder coatings, which can be used in wet environments and do not contain toxic substances, do not use solvents and are corrosion resistant resulting in significant extension of equipment life.

In larger wet cooling systems coatings are applied as well and experience in the power industry shows that they have to be renewed every 4 to 5 years. An example is given in Annex XI.

Antifouling paints have been applied that contain toxic substances, such as copper and tributyltin oxide (TBTO), that are slowly released from the paint. No paints containing TBTO are still in use in large installations such as power plants. Copper-containing paints may still be used on a limited scale.

3.4.4 Reduction by application of additional and alternative cooling water treatment

A number of techniques has been applied to reduce cooling water treatment. The following techniques have been reported for the reduction of biocide use [tm005, Van Donk and Jenner, 1996] :

- Filtration and pre-treatment techniques
- On-line cleaning
- Off-line cleaning
- Heat treatment
- Coatings and paints
- Ultraviolet (UV)-light
- Sonic technology
- Osmotic shock.

The principle behind these techniques is to improve the biological quality of the cooling water and to keep surfaces of the cooling systems elements (conduits and heat exchanger) as clean as possible, creating an environment in the system in which development of fouling will be reduced. The application of these techniques is summarised in Annex XI and it is obvious that

some may not have general application or are still under investigation. Environmental benefits should be balanced against the reduced application of chemicals.

For example, UV-light needs relatively clear water, whereas ozone and sonic technology will need extra energy input. Electric water treatment applied to a very small size cooling system (< 1 m³/min) operating at temperatures of 30 – 40 °C gave promising results as a non-chemical microbial control method, but needs further research.

Financial costs may vary with the size of the system and the extent to which the techniques must be integrated in the cooling system.

Pre-treatment of water for recirculating wet cooling systems to reduce cooling water additive use can be considered in the same light as pre-treatment of water to reduce water requirements (see Section 3.3.1.2). Pre-treatment will affect the chemistry of the cooling water, such as lowering the salt content, which will affect the required level of scale and corrosion inhibition, and will affect the way the cooling system is operated.

However, little has been reported on the effect of pre-treatment of cooling water on the reduction of cooling water additive use, but inverted osmosis for closed cooling circuits and sidestream filtration for open cooling systems with larger capacities have reportedly given good results (Annex XI). Lower costs for water intake, for treatment of the blowdown and for dosage of corrosion inhibitors, scale inhibitors and dispersants were reported. No redesign of the cooling system was necessary.

3.4.5 Reduction of emissions by assessment and selection of cooling water additives

After all technological and operational measures have been evaluated, assessment and selection of additives for cooling water conditioning is the next step to be taken towards the application of substances having lower potential for causing environmental impact if properly used. In Section 3.4.1 and more extensively in Annex V, the theory behind the treatment of cooling water has been described and the selection of the right treatment program clearly is a site-specific and very complex exercise. It takes into account many factors such as the applied material of the installation, the water quality and the operating practice. As a result of this a large number of compounds and their combinations have been developed and are currently applied in cooling water treatment compounds.

Their performance in the cooling circuit is evaluated and balanced with the residual reactivity in the aquatic environment after discharge. The challenge here is to select an additive effective in the cooling system, but harmless as soon as it leaves the cooling system and enters the receiving aquatic system.

The application of different kinds of cooling water chemicals in different kinds of cooling systems has been reported in the literature. It appears that their environmental impact is complex and depends on many different factors. Examples show clearly that optimised operation reduces the required amount of additives and that it can also lead to the application of different types of additives. (See 3.4.6).

Generally, in the EU, the assessment of chemicals is regarded as necessary and attempts have been made to develop an integrated methodology to reduce the environmental effects of their use, but the difficulties encountered on both a national and a European scale are that:

- there is a variety of evaluation methods used for various applications;
- the availability of data on substances and components of preparations is (still) a problem;
- a variety of parties are responsible for the evaluation of substances;
- risk-based assessment in many countries still has to be developed.

To control the application and enhance the use of alternatives, knowledge of characteristics of treatment chemicals in some member States has been translated into legislative requirements for cooling water treatment chemicals. German legislation is quoted below as example.

The Annex 31 of the German Federal Water Act on cooling water emissions is an example of legislation aiming at optimisation of the use of cooling water additives and on the conservation of the quality of surface waters. It has resulted in restrictions on the input of certain substances, such as biocides and other substances, and covers all wet-cooling systems (See Annex VI).

This regulations is based on four steps:

1. a list of prohibited substances, which contains:
 - chromium compounds
 - mercury compounds
 - organometallic compounds (e.g. organotin compounds)
 - mercaptobenzothiazole
 - organic complexing agents which are not readily biodegradable
 - no shock treatment with biocidal substances other than chlorine, bromine, ozone and H₂O₂
2. limitation of certain substances and groups of substances in the effluent concerning:
 - chlorine dioxide, chlorine and bromine
 - AOX
 - COD
 - Phosphorous compounds (inorganic and total/ phosphonates)
 - Zn
3. requirement of ready biodegradability of all organic substances used, where the applicable requirement “ready biodegradability” is in accordance with the Chemical Act and Part C4 of the Annex to Directive 92/69 EC (31 July 1992)
4. limitation of the ecotoxic effects of the total cooling water effluent of biocidal substances used does not prohibit their use as it would make the application of microbiocidal substances impossible. However, they can be essential for the operation and proper functioning of open and semi-open cooling water systems. The regulations require information on the level and character of toxicity and call for this to be expressed in a reproducible manner. Use is made of biotests such as dilution factor (T₁) to express the residual toxicity in the discharge compared to the toxicity in the cooling system.

Despite legislative limits on the use of a number of cooling water chemicals, a large number of additives is available and assessment and selection of alternatives is required taking into account site-specific factors such as the cooling systems operation and the sensitivity of the receiving environment. Also, a translation of specific national regulation would fall short of the general applicability within the framework of a horizontal “approach”.

Thus, substitution of substances by others, which have lower potential for impact on the environment, is one of the options to reduce the environmental impact of cooling water discharges. Permitting authorities in the Netherlands have been using the instrument of substitution for more than 20 years in permitting procedures. The basis of this instrument is a procedure of approval in permits. By means of a more or less administrative procedure permit holders have to submit a request for the use and change of cooling water additives. Permitting authorities use a widely approved procedure for this assessment. It is expected that in the near future chemical suppliers and industry will move to a system of self-regulation. The revision of the system is part of the adoption of a general evaluation methodology to identify the water pollution effects of substances and preparations. This evaluation methodology is based on the European legislation on classification, packaging and labelling (67/548/EEC, 99/45/EC).

In general terms the assessment of cooling water additives takes place in three steps [Benschop (1998)]. The first step is an assessment of the intrinsic properties of substances. Substances are evaluated on the basis of their ecotoxicological characteristics (carcinogenicity, acute aquatic toxicity, biodegradation, Log P_{ow} and bioconcentration factor). In order to be able to evaluate the substances and preparations, it is necessary to know the substance or the precise composition of a preparation. International industrial programmes (Responsible care, ICCA), European legislation (Biocidal Products Directive) and the development of chemicals management on the EU-level contribute to those data on properties of substances becoming more and more available.

The first step results in an indication of the hazard potential of the additive. The evaluation and selection through the assessment of the hazardousness applies a hazard identification test to substances and to their preparations. It is a test which has been developed in the Netherlands ([tm070, Benschop, 1997] and [tm071, Niebeek, 1997]) and is particularly based on the Dangerous Substance Directive (67/548/EEC) and the Directive Hazardous Preparations (88/379/EEC). The test focuses on the ecotoxicological characteristics of a substance. This involves mutagenicity, carcinogenicity, acute toxicity and biodegradability, log P_{ow} and the bioconcentration factor. However, this needs data that are not always readily available, partly for reasons of confidentiality and partly because data have not been collected yet.

To evaluate or benchmark additives with alternatives, which have lower impact on the receiving environment, can assist in the assessment and selection. In Annex VIII.1 an example is given of how at site level a benchmark method could be applied to get a first indication of the potential for impact of the proposed alternative additives. This benchmark is designed for an open wet recirculating cooling system (open cooling tower). It aims to calculate a “standard” PEC for a preliminary evaluation of PEC in the river. It is a simplified model assuming that there is no dilution of the additive in the river, thus overestimating the concentration of the substance in the receiving waterway. Also, PEC is assumed to be independent of the size of the plant and the operating conditions as the model takes into account the feed rate of the chemical(s). The availability of environmental quality standards (EQS) of the chemicals as provided by the Water Framework Directive is important.

The second step involves optimisation steps to reduce the use of the selected additives by all sorts of operational steps (see next Section 3.4.6). In the third step the residual discharge is then evaluated in comparison with the applicable water quality objectives or environmental quality standards (EQS). If these objectives are not reached, further measures may be indicated. When alternative additives are available the need to take measures can be avoided by substitution of hazardous additives by less hazardous alternatives.

The added value of this procedure of assessment of additives related to the regulation on chemicals based on the above-mentioned EU directives is:

1. the ability to identify additives with the lowest environmental impact and
2. the ability to determine whether local water quality objectives are met.

If this assessment method (which is generally applicable for substances and compounds) is applied to biocides, the first step automatically results in the need to take further measures. In practice, this means conducting a study for an optimisation programme for the use and dosage of the biocide. The second step, which more or less runs parallel with the study for optimisation, involves the evaluation of predicted effects on the local aquatic ecosystem.

With this evaluation three criteria are being checked and, if all three criteria are met, further reduction measures including effluent treatment and/or substitution of the additive should be applied. In the Netherlands the predicted concentration of a biocide is checked against the Maximum Admissible Risk Level (MARL).

Further measures should then be applied if:

1. the concentration of biocide in the effluent is higher than the MARL, and if;
2. the added concentration of biocide in surface water on a certain distance from the discharges exceeds more than X % of the MARL, and if;
3. the total concentration of biocide in surface water at a certain distance from the discharge exceeds the MARL.

The assessment procedure described is illustrated in more detail in Appendix VIII.2.

3.4.6 Optimising the use of cooling water additives

Optimising the use of cooling water additives also means selecting the appropriate dosage regime and monitoring the effects of the water treatment programme both on the emissions to the surface water and on the performance of the cooling system in terms of heat transfer and safety. It is obvious that both techniques are linked and that monitoring is a prerequisite for the appropriate dosage regime.

The selection of a dosage regime should aim to achieve the required concentration at the right time, without a reduction of the performance of the cooling system. Underdosage can cause corrosion or scaling and a reduced performance of the cooling system which also leads to indirect environmental effects, and an overdose of chemicals can result in fouling of heat exchange surfaces, higher emission levels and higher treatment costs. Graphically this can be represented as in Figure 3.4. In the improperly designed system no account is taken of the required minimum concentration of a biocide to keep the system protected against fouling, so some fouling may occur. At the same time overdosing leads up to such concentration levels that more than the maximum required concentration is available. At that moment excess additive will be discharged into the environment.

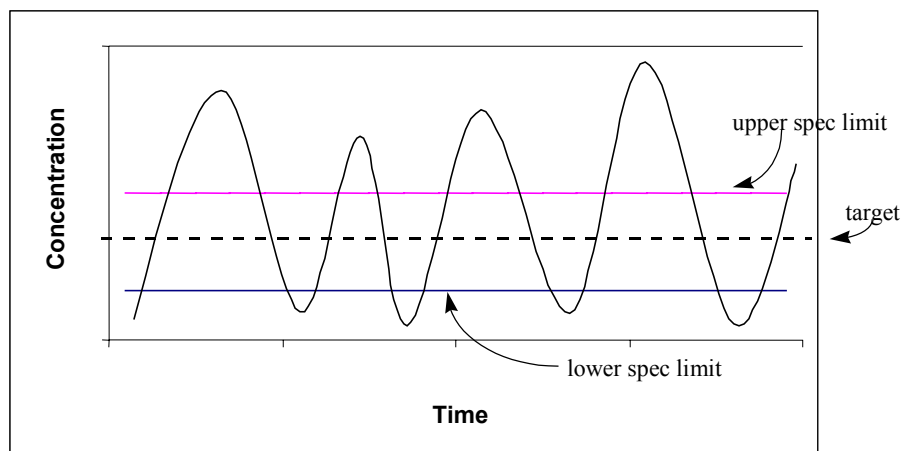

Figure 3.4: Additive concentration pattern resulting of improperly designed monitoring and dosage regime

Targeted dosage (Figure 3.5) based on analysis of the cooling water quality aims at maintaining the minimum required concentration level to give constant protection. Excessive concentration levels are avoided and thus discharge into the environment is reduced, which will also reduce costs to purchase the treatment. For this, properly designed dosage regimes will reduce the amount of additive needed and can be considered as a cost-effective measure.

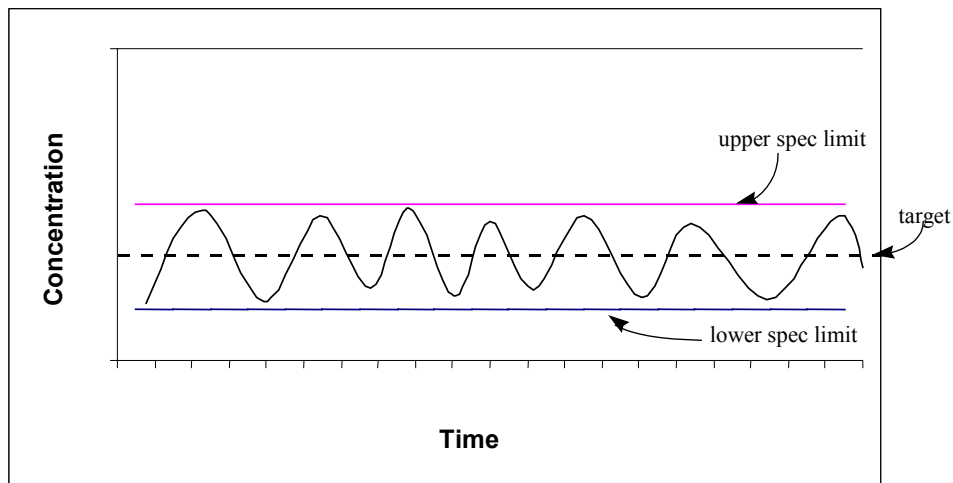

Figure 3.5: Additive concentration pattern resulting of properly designed monitoring and dosage regime

3.4.6.1 Dosage of cooling water additives

3.4.6.1.1 Dosage regimes

([tm010, Betz, 1991], [tm005, Van Donk and Jenner, 1996] , [tm157, Jenner et al, 1998])

Dosage of cooling water chemicals is done in the following ways (see also Annexes V and XI):

- continuous
 - end of season
 - periodic during settlement
 - low level during settlement
- intermittent (also called shot, batch)
- semi-continuous or pulse-alternating
- massive or shock dosage, where a large amount of chemical is added to the cooling water at once.

Continuous dosage is practised in cooling systems where a certain level of additive has to be maintained constantly. The better systems feed according to the volume being treated and the chemical demand requirements. It is still applied in once-through systems predominantly against macrofouling and corrosion. However, experiences show that reduced use through changed dosage practice can be just as effective.

With intermittent dosage the chemical is fed by an on/off control on a chemical feed pump or by discharge from a calibrated vessel or measuring chamber. Batch dosage is applied in cooling systems, bio-oxidation basins, and other places where the system volume to blowdown ratio is large. In these systems the amount of chemical replenishes lost or consumed material. It is also used in applications that only require periodic dosage. For instance, antimicrobials for cooling water systems are usually fed in a discontinuous way. Batch dosage can both be applied in recirculating systems and once-through systems. It cannot be used in single once-through systems where a uniform concentration of chemical is needed.

Dosage can also be targeted on specific areas in the cooling system such as at the entrance to heat exchangers. An important practice is time-targeted dosage matched with seasonal characteristics of microbiological growth. Dosage will also depend on the type of cooling system. In recirculating systems the way the system is operated will affect the timing and amount of dosage. In once-through system, the point and time of dosage is important to obtain the highest effect, as contact time between chemical and cooling water is short.

In small systems dosage is done manually, but in larger systems there is usually an automatic device linked to a monitoring system. As mentioned before, there is a tendency towards outsourcing the cooling water treatment to specialist companies. For large and complex installations with several cooling systems, specialised staff from suppliers are permanently on-site to operate these systems. With smaller systems, daily control is often done by site staff and supported by regular control by the supplier.

With optimisation of dosage reduction of biocide use can be achieved. The way in which biocides are being dosed depends on the working and persistence of the biocide, the type and seasonal pattern of fouling (macro/micro), the state of fouling of the cooling system, the system water temperature and the nutrient status of the cooling water. Biocides are dosed in gaseous, liquid or solid forms.

Dosage can be continuous or shock. In some of the literature it is advocated that continuous dosage should take place in once-through systems to extend the contact time of antimicrobials when dosage low levels. For recirculating systems continuous dosage is also possible, but intermittent dosage is more common. The purpose of intermittent treatment in these systems is to generate a high concentration of antimicrobial, which will penetrate and disrupt the biofilm and eventually dissipate. Compared to continuous treatment intermittent treatment can lead to lower average annual concentrations in the effluent and can also be more cost effective, where lower total amounts are needed. However, this has also been argued as observations were made that continuous dosage could give a reduction of 40% of FO compared to shock dosage. More research on this will be needed as in general from an operators' point of view continuous dosage is easier to operate than shock or intermittent dosage. This will need a monitoring system to decide on the appropriate moment to apply the treatment. The optimisation of the dosing regime must take place with achieving a low incidence of failure at the same time.

In recirculating systems use of products composed of synergistic active blends can result in reduced treatment concentrations in the blowdown water, as well as cost savings. Biocides with different spectrums can be dosed in combination as to broaden the spectrum of control. With no increase in the amount of antimicrobial used, the power of a blend can exceed the effect expected from a single additive effect. This greatly enhanced performance or synergism is obtained from only certain combinations of additives. The feeding does not necessarily be done simultaneously, but can be done alternating with similar results. Another effect is that resistance is less likely to occur in the case of more than one microbial being applied against which it is unlikely that the microbes will have developed resistance to both (or all) at the same time. Interactions between different substances will have to be considered to avoid reduction of the working of any of the biocides dosed and to avoid hazardous reaction products develop in the cooling water discharge.

The objective of biocidal treatment can be different. Depending on the target organisms and the extent to which biofouling has progressed, treatments are either preventive or curative. A biocide that has been researched intensively is sodium hypochlorite. Dosage of hypochlorite into a once-through system shows that the cooling system will function as a tube reactor, with many complex reactions taking place between hypochlorite and organic matter. As a result of such reactions, and for a typical location, using estuarine or coastal cooling water, a hypochlorite dose at the intake, ranging from 1.5 - 3 mg Cl₂/l, will result in a dose of 0.25 – 0.35 mg/l of TRO at the outlet of the heat exchanger. This refers to approximately 4 - 8 minutes of reaction time. To reduce the dosage of hypochlorite considerably, pulse-chlorination[®] has been applied (Annex XI.3.3.2.1 and X.3.3.2.1).

3.4.6.1.2 Dosage systems

([tm010, Betz, 1991])

There are several dosage systems on the market. For the choice of dosage system one should distinguish between liquid and dry chemicals. For liquid chemicals, pumps are used such as

metering pumps, packed plunger pumps (high pressure) and diaphragm pumps. For dry chemicals dosage systems are applied such as volumetric feeders (to dispense powdered material), gravimetric feeders (proportioning chemicals by weight) and dissolving feeders (dosage into mixing tank). Whether and how the different dosage systems applied actually reduce the consumption of additives has not been reported. It is beyond doubt that proper maintenance of the system and calibration will improve the dosage accuracy. The quantity, location and timing of dosage can only be controlled in an accurate way by properly monitoring the water cooling system.

3.4.6.2 Monitoring of cooling water

Monitoring of the need for chemicals for treatment of cooling water is essential to reduce additive use and emissions into the environment, generally the surface water. It can be seen as a cost-effective method, where treatment of discharge water, if possible at all, is generally more expensive.

Distinction can be made between the monitoring of the application of biocides and monitoring of other water treatment chemicals (scale inhibitors, corrosion inhibitors and dispersants), because in the case of macrofouling an important additional factor is the monitoring of the behaviour of the biology appearing in the cooling system.

3.4.6.2.1 Monitoring of scale inhibitors, corrosion inhibitors and dispersants ([tm067, Hoots et al, 1993])

The application of inhibitor chemicals and the optimisation of their use is a very complex matter and specific for each situation. In every case it will be a balance between a number of factors:

- the quality of the cooling water and the options for pre-treatment (softening, filtration), which in its turn depend on the required flow;
- the need for reducing water requirements by increasing the number of cycles against the increase of scaling problems due to the increased concentration;
- the cooling water temperature against the solubility of salts;
- the interaction between additives.

Several methods are applied for controlling the dosage of cooling water inhibitor products in recirculating cooling systems. In an overview [tm067, Hoots et al, 1993]. The following general techniques were distinguished as being applied in cooling systems:

- manual testing and adjusting
- bleed and feed (blowdown-activated feed)
- water meter controlled cycles
- sidestream chemical analyser (microprocessor based)
- fluorescence.

Each method obviously has its advantages and disadvantages. The principle of the optimised pattern shown in Figure 3.5 may not be reached. The various monitoring techniques differ in their potential to dose the proper amount. A variation in the dosage which is not linked to fluctuations in the cooling system demand should however be avoided as much as possible. It may lead to an under dose or overdose of chemicals.

Variation in dosage can occur for a number of reasons:

- operator may be insufficiently involved
- equipment has low reliability
- indirect measurement of chemical level
- measurement of wrong variable
- time lag between the analysis and the adjustment is too large

- repeatability of the method of analysis may be low
- variations in cooling load and makeup water quality are not followed accurately.

From experience it is obvious that the most accurate monitoring and dosage systems directly measure the concentrations of chemicals in the cooling water and have a reduced time between analysis and the adjustment of the dosage. Monitoring systems should be able to follow the changes in cooling load and the variation in makeup water quality (Annex XI).

3.4.6.2.2 Monitoring of biofouling

([tm005, Van Donk and Jenner, 1996] and ([tm087, Engstrom and Tully, 1994])

The monitoring of biofouling is based on the monitoring of microbiological activity in the cooling system as well as the actual microbiocide treatment levels. The key to measuring the effectiveness of any biocide program is the ability to measure quickly and accurately the microbiological activity in the cooling system.

To obtain a good dosage regime the following strategy for once-through systems has been suggested:

- make a problem analysis on the organism(s) to target
- characterise seasonal differences in occurrence (e.g. breeding period of mussels)
- take into account water temperature and water quality (fresh/salt)
- select a dosage programme (e.g. locally per section: continuously or intermittently)
- decide on the dosage units that will reduce consumption especially if linked to a monitoring system
- decide on the monitoring programme (mussel detection tank (breeding period determination) or mussel/oyster monitor (concentration detection))

A similar strategy could apply to open recirculating wet systems. However, the dosage programme for additives used in cooling towers also covers inhibitor chemicals, which further increases the complexity of a treatment. An additional factor is the effect of operation with an increased number of cycles of concentration, which saves water on the one hand, but increases the possibility of scaling and corrosion and the need for specific additives on the other hand. In this situation less corrosion-sensitive materials may be the obvious choice in the design phase of new installations. They could reduce the need for inhibitors (see 3.4.3.2), enabling operation without adding complex agents, which at the same time saves on costs.

For both new and existing cooling systems it is important to establish the cause of biofouling (e.g. leakage) and to characterise the organisms first before deciding any further on the required biocide.

For once-through systems, macrofouling is of major importance. A prerequisite for biocide treatment is monitoring of macrofouling. This is essential to establish the minimum required biocide dose and for biocide optimisation, as it will give information on the settlement and growth of macrofouling organisms and on the performance of the biofouling control program.

An even more targeted dosage regime is the pulse alternating chlorination[®] which takes account of the variation in residence times in different parts of the process. At different times and at different points the required levels of chlorine are dosed following the flow patterns of the cooling water stream in the different process stages. At the end of the process and before discharge of the cooling water, stream dilution occurs by the mixing of the different process streams. Where only one of the streams is chlorinated and the other is not, the TRO can be further reduced and emission levels of < 0.1 mg/l are achievable (see Annex XI).

For open recirculating systems microfouling is much more important than macrofouling. As the amount of water used for makeup generally is much smaller, both pre-treatment of the water and

side-stream filtration of part of the circulating water can prevent the entrainment of micro-organisms. In the case of shock dosage of biocides, recirculating systems have the advantage that the system can be closed temporarily, enabling the biocide to perform and thus lowering the concentration before blowdown. Also, for recirculating systems, monitoring of the biofouling control program is a prerequisite for optimizing the use of biocides.

3.5 Cooling air use and air emissions

3.5.1 Air requirements

The use of air as a resource has no direct environmental implications and is not regarded as a real consumption. Air is used in all but the once-through cooling systems. In mechanical cooling towers the air requirement is related to the energy required for fan operation.

Table 3.9: Average required airflow for the different cooling systems [tm134, Eurovent, 1998]

Cooling system	Airflow (%)
once-through flow	0
open wet cooling tower	25
open wet/dry (hybrid) cooling	38
closed circuit cooling tower	38
closed circuit wet/dry cooling	60
closed circuit dry air cooling	100

The higher the required amount of air the higher the fan capacity and consequently the level of energy consumption and noise emission. In Table 3.9 the airflow requirements are compared for the various cooling systems. The airflow is strongly correlated with the ratio between sensible and latent heat transfer (Annex I). Dry cooling needs more air than wet cooling.

In some specific areas (e.g. densely industrialised sites) the air quality could be an issue and by its composition could lead to corrosion of the (finned) tubes or coils or to fouling of the surface, in both ways adversely affecting efficient heat exchange. Precleaning of cooling air seems unrealistic and no information on this has been reported. Consequently, cleaning of the surface of the heat exchanger and/or treatment of cooling water might be necessary depending on the chemistry of the air.

On the other hand, open wet cooling towers sometimes act as air cleaners, washing several pollutants out of the air. This can affect the cooling water treatment and potentially the operation of the cooling system, but no data have been reported.

3.5.2 Direct and indirect emissions

Emissions into air due to the operation of industrial cooling systems can be direct or indirect. Indirect emissions occur on the level of the production process due to inefficient cooling. They are due to the fact that inefficient cooling requires a higher input of resources (such as energy) to compensate for product or performance losses.

The importance of direct air emissions from wet cooling towers is particularly relevant in the direct vicinity of urban settlements. In comparison with the air emissions of the industrial process to be cooled, they are considered to be relatively small. Problems that may occur during operation are:

1. droplets may contain some water treatment chemicals;
2. bacteriae (Legionnaire's disease) may develop in case of improper biocide treatment and cooling tower maintenance (3.7.3).

Open and closed recirculating wet and wet/dry cooling towers may show some emissions due to drift and volatilisation, which account for some loss of water treatment chemicals and in

particular of biocides. It is known that volatilisation, also called flash-off, of chemicals increases with temperature, but the mechanism that leads to emissions is complex, with many factors involved. Therefore, quantification is difficult and no emission data have been reported.

Drift eliminators are considered to be an important reduction measure. All wet cooling towers nowadays are equipped with drift eliminators, but still a small percentage of the circulated water stream may be exhausted as water droplets. These droplets containing dissolved particulate and chemical additives fall out of the exhaust airstream downwind of the cooling tower and can cause staining or scale deposits on building surfaces [tm046, Vanderheyden and Schuyler, 1994]. Some specific cases are known in which chromium emissions are reported, but most Member States have prohibited chromium use for environment and health reasons; it is also reported to give technical problems.

The quality and quantity of direct air emissions from cooling towers will be specific in each situation depending on the additives used for cooling water treatment, their concentration in the circulating water and the effectiveness of the drift eliminators. The standard droplet separators currently used in wet cooling towers make it possible to limit the loss of water by drift to 0.01% or even less of the total flow rate. An attempt was made to assess cooling tower emissions using a simplified model [tm046, Vanderheyden and Schuyler, 1994]. From the data obtained it was concluded that emission concentrations are low ($\mu\text{g}/\text{m}^3$), but not to be neglected, and that design and positioning of the cooling tower outlet are important to avoid inlets of air conditioning systems or other cooling installations.

Currently no standardised method exists to calculate drift losses (and environmental contamination) for given cooling tower configurations. Two test methods exist to verify drift losses of given configurations (not published):

- the isokinetic method (IK-method)
- sensitised surface drift measurement (SS-method)

Both methods have their advantages and disadvantages. Advantages of the IK-method are:

1. High collection efficiency on all droplet sizes,
2. Analysis of specific elements possible,
3. Provides integrated sample over exit area,

The disadvantages of the IK-method are:

1. Airborne elements may bias results
2. Long sample times required for high efficiency drift eliminators or low mineral concentrations.

A test code exists describing how to conduct the IK-test (CTI-140).

The SS-method has the following advantages:

1. Provides droplet size characteristics above 30 μm ,
2. Not affected by airborne elements,
3. Provides relative indication of drift eliminators effectiveness,

Disadvantages of the SS method are:

1. Poor collection efficiency on small droplets less than 30 μm ,
2. Cannot distinguish between condensation and drift,
3. No droplet analysis for specific constituents.

Incidental emissions of asbestos particles have been reported during decommissioning of old cooling towers in which asbestos-cement has been used, requiring specialised measures to contain them. A report on the reduction of the emission of asbestos particles during decommissioning focused on protecting against direct inhalation [tm082, Mittendorf, 1990]. As the use of asbestos and similar materials has been banned in the EU no asbestos is used in new

or recently built cooling towers. Asbestos can still occur in cooling towers of about 20 years and older.

Air emission abatement on cooling towers has not been reported and does not seem applicable. In the light of the origin of the potential contamination and the way it is transported, the following conclusions have been drawn:

- Reduction of air emissions from cooling towers is positively correlated with the integrated measures for reducing water intake, in particular application of drift eliminators,
- Reduction of air emissions is positively correlated with the reduction of the need for cooling water treatment, and
- Reduction of air emissions from cooling towers is positively correlated with the optimisation of cooling water treatment (optimisation of system operation).

3.5.3 Cooling tower plumes

3.5.3.1 Plume formation

Plume formation can be important in open and closed wet cooling towers when air with a high moisture content leaves the cooling tower, mixes with the atmosphere and begins to cool down. During this process some of the excess water vapour that has been absorbed is condensed out again. Although this is almost 100% water vapour, the horizon marring effect can be considerable in case of large towers (power industry, chemical industry). The shape and the extent of the visible plume are influenced by the temperature and the relative humidity of the atmosphere, and also by the wind. The colder and the more humid the atmosphere, the more stable and the more persistent the plume will be. It can therefore be considered to be a potential problem of the more temperate or colder regions in Europe and mainly in wintertime. Extreme plume formation from large installations (power plants) can also result in fog at ground level in the case of lower towers (40-50 mtr.). It is also reported that, during extreme weather conditions, can be formed on roads ice as a result of large plume formation followed by precipitation.

3.5.3.2 Plume abatement

[tm101, BDAG, 1996], [tm123, Alt and Mäule, 1987]

Plume abatement is a technological integrated measure changing the configuration of the cooling system. Plume formation can be prevented, drying the wet exhaust air before it is discharged, by mixing it with some warm dry air. Open hybrid (or wet/dry) cooling towers and closed wet/dry cooling towers (or coolers) are designed in particular to prevent plume formation. (See Section 2.6)

Depending on the climatic conditions and the requirements of the process, the tower can be operated dry. For northern European climatic conditions it is maintained that it only needs 20% of the total heat load to be transferred in the dry section for the cooling tower to operate without a visible plume, under virtually all weather conditions. In certain conditions, such as at very low ambient temperature and a low thermal load, the tower can also be operated in entirely dry mode. Regulations sometimes distinguish between day and night operation and allow wet cooling (with a plume) during the night, whereas in daytime the tower must be operated in hybrid mode, preventing plume formation. (See also Chapter 2).

3.6 Noise emissions

3.6.1 Sources of noise and noise levels

Noise emissions are important at a local level. Noise emissions from an industrial complex result from a range of noise-producing sources and in the practice of permit writing cooling system noise is considered as an integral part of the whole site. Consequently, noise from cooling systems and the investment on potential attenuation measures should be evaluated within the total noise emissions of a site. Noise emissions are generally an issue of both mechanical draught cooling towers and large natural draught wet cooling towers. For information on characteristics and calculations of noise emissions of sound sources in cooling towers, reference can be made to the VDI-Directive 3734 and to standards developed in the German VGB-guidelines for cooling systems of power plants [tm158, VGB, 1998].

Three main sources of noise caused by these cooling systems can be identified:

- fan assemblies (fan, gears, drive) - all mechanical cooling towers;
- pumps - all systems with cooling water
- droplets falling on the cooling water basin/ cascading watermasses - only wet cooling towers.

Radiation can be directly or indirectly. The sound is directly radiated through:

- points of air intake
- points of air discharge

The sound is indirectly radiated through:

- fan motors
- fan discharge cowls and cooling tower cladding (with concrete constructions there is no significant contribution)

Noise from dry air-cooled towers is predominantly influenced by the mechanical equipment applied and the way it is operated. In cases where attenuation has resulted in a very low sound power level of the equipment, noise from heat exchangers or condenser pipes and conduits may become predominant.

In wet cooling towers, noise is a result of the falling water droplets only (natural draught) or of both the falling droplets and the mechanical equipment. Generally the unattenuated noise of fans is dominant compared to the noise of water droplets. This is reported to be irrespective of the size of the wet cooling tower. When air-related noise is reduced by attenuation measures, water-related noise may become dominant and water noise attenuation may be considered.

For medium to large cooling towers operated in power stations and large industrial plants the following was reported. For natural draught cooling towers, water flow and tower height are the most important factors affecting unattenuated noise emission levels. Falling height of the droplets is important up to 5 m., but with larger falling heights no further influence on the total noise was reported. The sound power level at the inlet can be calculated according to the equation:

$$L_w \text{ (dB(A))} = 68 + 10 * (\log M/M_0) \pm 2 \quad M_0 = 1 \text{ tonne/hr}$$

The sound power level at the air outlet of natural draft cooling towers can be approximately calculated with the following equation:

$$L_w \text{ (dB(A))} = 71 + 10 * (\log M/M_0) - 0.15 * (H/H_0) \pm 5$$

$M_0 = 1 \text{ tonne/hr}$ ($M = \text{weight rate of water flow}$)
 $H_0 = 1 \text{ m}$ ($H = \text{height of the cooling tower}$)

For fan operated wet cooling towers the spectrum of water noise at the inlet is not much different. For cooling towers with induced draught (fan in top of tower) the contribution of the water noise in the air outlet (diffuser) to the total sound power level can be calculated approximately using the following equation:

$$L_w \text{ (dB(A))} = 72 + 10 * (\log M/M_0) \pm 3 \quad M_0 = 1 \text{ tonne/hr}$$

The most relevant factor in mechanical cooling towers is the mechanical equipment used (fans, gears, etc). Fan tip speed (25-60 m/s) is a major influence on the total noise level. The type of fans used (centrifugal or axial) as well as the number and type of blades are also of importance. It was reported that use of gearboxes can have negative influence on the sound level (at the same water flow and fan tip speed), if the fan speed is reduced (e.g. nighttime operation), when they become more dominant.

The sound power level of a fan can be calculated approximately using the equation:

$$L_w \text{ (dB(A))} = 16 + 10 * (\log V/V_0) + 20 * (\Delta p/\Delta p_0) \pm 5$$

($V_0 = 1 \text{ m}^3 \text{ of air/h}$; $\Delta p_0 = 1 \text{ hPa}$)

This general equation can be used for both forced and induced draught fans. In forced draught towers the contribution of the fans to the sound power level at the air outlet of medium to large cooling towers will generally be less than the contribution of a fan of an induced draught tower with the fans at the top. This difference can be up to 5 dB(A).

The following equation was used showing how the sound power level of axial fans is related to the tip speed of the fan:

$$L_w \text{ (dB(A))} = C + 30 \log U_{\text{tip}} + 10 \log (Q * P) - 5 \log D_{\text{fan}}$$

(C = fan characteristic shape value, U_{tip} = fan tip speed, Q = fan flow, P = fan pressure drop, D_{fan} = fan diameter)

Noise emissions also depend on the construction of the cooling tower. Noise from concrete towers is entirely emitted through the air inlet and air outlet. For cooling towers made of different lighter material, emission from the shell will have to be taken into account. Furthermore, counter-flow or cross-flow design also affects the sound emission of wet cooling towers, where counter-flow is reported to have more splash noise than cross-flow designs.

Noise emissions can be characterised by the different frequencies they consist of and distinction can be made between natural wet draught cooling towers and mechanical cooling towers. Falling water in natural draught towers shows a broad frequency band, whereas the noise of fans of mechanical cooling towers predominantly consists of low frequencies. This, amongst other factors, can explain why water noise typically prevails in near-field conditions around the installation, while the noise of the fans will become progressively predominant with increasing distance from a fan operated cooling tower.

The sound power levels of different cooling towers show a large variation and each single source will contribute to the total emission. This is illustrated by examples in Table 3.11 for power stations [tm158, VGB, 1998] and in Table 3.10 showing values for the different cooling systems used in a refinery [tm001, Bloemkolk, 1997].

Noise levels of the falling water in wet cooling towers depend on the drop height of the water. Lower drop height in induced draught wet cooling towers results in about 1 dB(A) lower sound power level at the air inlet and of a so called cell type cooling tower with induced draught, 3 dB(A) lower.

Table 3.10: Examples of capacity and associated unattenuated sound power levels of cooling systems equipment of a large refinery [tm001, Bloemkolk, 1997]

Equipment	Capacity ¹	L_w in dB(A)
Compressors	490/ 2000 kW	108/ 119
Pumps	25/ 100/ 1300 kW	94/ 98/ 108
Steam turbines	1000/ 2000 kW	106/ 108
Air-coolers	7 /20 / 60 kW	89/ 93/ 98
Air-cooler/condenser	170 kW	102
Air-cooler/condenser	2.7 MW _{th}	97
Air-cooler	14.7 MW _{th} / 18.8 kW _e	105
Air-cooler	1.5 MW _{th} / 7.5 kW _e	90
Cooling towers	300 MW _{th}	106
Cooling tower	2000 m ³ /hour	105

Notes:
1. reference to the capacity of the rotating part, motor, etc., i.e. not cooling capacity.

Table 3.11: Comparison of unattenuated sound power levels at air inlet and air outlet measured at various types of wet cooling towers of conventional construction [tm158, VGB, 1998]

Wet cooling tower construction	At air inlet in dB(A)	At air outlet (diffusor opening) in dB(A)
Natural draught	84 ± 3	69 ± 3
Open wet cooling tower	86 ± 3	80 ± 3
Open wet cooling tower (cell type, forced draught)	88 ± 3	85 ± 3
Open wet cooling tower (cell type, induced draught)	85 ± 3	88 ± 3

For comparison of total sound power levels of various types of cooling systems Table 3.12 documents total noise levels for different types of cooling systems without noise attenuation. From the above given variation in levels it can be understood that the ranges are wide depending on the applied design and equipment.

Table 3.12: Noise emissions of different cooling systems without noise attenuation [tm134, Eurovent, 1998]

Cooling system	Noise emission dB(A)
once-through flow	
cooling tower-natural draught	90-100
cooling tower-mechanical draught	80-120
closed circuit cooling tower	80-120
hybrid cooling	80-120
dry air cooling	90-130

3.6.2 Noise abatement

([tm158, VGB, 1998], [tm061, Eurovent/Cecomaf, 1997], [tm086, Van der Spek, 1993], [tm093, Mirsky, 1995])

Noise abatement should primarily be focused on so called primary measures or “internal” measures before considering any secondary or “external” measure such as baffles or big barriers. Different guidelines on noise abatement of cooling towers distinguish between noise generated by cascading water and noise of mechanical equipment. In general, natural draught cooling towers are less noisy (unattenuated), but for mechanical draught cooling towers sound attenuation is more efficient. Obviously, proper maintenance of the noise generating equipment over time can keep the emission down as well. In most cases only mechanical draught cooling towers can meet the noise requirements because only the mechanical draught can economically overcome the additional airside pressure drop. The selection of less noisy radial fans often implies higher energy consumption and results in higher operating costs than axial fans.

The general “approach” is to apply the primary measures first to optimise noise emission. If further noise reduction is needed additional attenuation can be considered. Noise attenuation should be done bearing in mind the effects of abatement measures, such as pressure drop (more energy required) and other sources becoming more dominant. The contribution of individual equipment to the sound emission level must be seen as part of the whole noise pattern. This means that nearby buildings, dispersal and reverberation, amongst many other factors, must be taken into account as well. To lower the emissions from the different potential noise sources in cooling systems the above given equations clearly show on what issue the reduction measures should focus, such as drop height and fan tip speed.

3.6.2.1 Noise control of cascading water (wet cooling towers)

In natural draught cooling towers the sound attenuation focuses on the air inlet, because the air outlet contributes insignificantly to the total noise level, at least being 5 dB lower. Sound generated in the basin by falling water is already reduced to some extent by radiation in the tower, the tower fill and the plume (10-15 dB). Further attenuation can reduce the emission from the air inlet by a further 5-8 dB. The following measures are suggested and could be applied to medium to large mechanical cooling towers as well.

3.6.2.1.1 Primary measures

The following techniques have been identified as primary measures:

- Lowering the water surface by faster draining of the basin would use the basin walls as sound barriers.
- Reducing the drop height of the water is possible by minimising the sectional area of the air inlet, which is limited.
- Avoiding the impact of droplets in the basin is possible by devices catching the drops and draining them into the basin (impact deflectors) Effect: 7 dB maximum.
- Water collection troughs underneath the fill also have a deflecting effect: 10 dB maximum. Disadvantage of the deflection methods is the susceptibility to fouling of the surfaces of the catching devices, which can potentially contaminate the water.

3.6.2.1.2 Secondary measures

Secondary measures that have been applied are:

- Sound attenuators with baffles at the air intake: 20 dB maximum reduction. Disadvantage could be the air pressure drop, which can be about up to 10 Pa. Pressure loss can require 20% of the installed fan capacity.
- Earth barriers around the tower base: an attenuation effect of 10 dB.

- Sound walls (or screens) with sound absorbing layers yield a sound attenuation of 20 dB. With these constructions effectiveness depends on construction and distance to the tower base.

3.6.2.1.3 Dry-cooling towers

Noise from dry cooling towers is predominantly caused by fans, but for medium to large dry-cooling towers, the noise of water can become dominating when it flows through the heat exchangers at higher velocities. In the case of condensers, the sound may become distinct when low noise equipment is being used, and the flow noise of condenser tubes may reach the same magnitude as the fan noise. In those cases further sound attenuation may become important and isolation of connecting pipelines must be considered.

3.6.2.2 Noise control of mechanical equipment (mechanical draught cooling towers)

For the noise control of cascading water in medium to large mechanical draught cooling towers the same primary measures as were mentioned for natural draught towers can be referred to. Additionally applied are:

- grids or woven structures of fine meshes, drifting on the water surface to reduce the splash noise of falling droplets. No quantification of the reducing effect has been reported.

Noise attenuation of mechanical equipment refers mainly to reduction of fan-related noise in both wet and dry cooling towers. Applied measures are primary (equipment) or secondary (absorption). The various sound attenuation measures achieve noise abatement levels of about 20 dB(A) and up to 30 dB(A). For these high noise abatement levels it is necessary to combine more quiet equipment with additional sound attenuation, such as acoustic baffles or noise attenuators. Such equipment for passive sound attenuation will increase the investment costs, but operating costs remain reasonable.

3.6.2.2.1 Primary measures

The following primary measures have been reported:

- Fan measures:
 - low power fans (couple of dB(A) reduction);
 - larger air cooler fan can make a difference of 2-6 dB (A); number of blades, 6-8 instead of 4, makes a difference as well (also lowering the energy requirement);
 - use of low noise fans with wider blades and lower tip speeds (< 40 m/s) for the same airflow and air pressure;
- Low noise gear drives (small transmission ratios or multi-pole drive motors), helicoidal gears instead of right angle gears, belt drives and, if possible, direct drives.
- Belt drive by V belt, flat belt or low noise moulded notch belts. If possible, belts should encapsulated;
- Low noise fan motors;
- Centrifugal instead of axial fans;
- Largest possible distance between fan blades and support construction;
- Use of flexible support of gears and fan motors;
- Aerodynamic design of the air passages.

Further reduction can be achieved by the way the equipment is operated. The number of revolutions per minute can achieve further reduction of fan noise. In a period of lower demand (nighttime) fans could be operated at a lower rotation speed and a 50% reduction of speed can result in a noise reduction of about 6-10 dB(A).

3.6.2.2.2 Secondary measures

Secondary measures for mechanical draught cooling towers at air intake and discharge are beneficial. Compared to the advantage of a sound reduction with 10 to 25 dB(A) a higher pressure drop of 20 to 70 Pa must be accepted, which must be overcome by extra energy input or larger (noisier) fans.

Examples are:

- The muffling of airflow and housing can contribute with a reduction of 5 dB(A).
- Sound absorbent construction crosses, which are built in the air outlet (diffuser) of smaller fan cooling towers, reduce the sound emission and also give a better flow line pattern and by this a better draft.
- Droplet separators in wet cooling towers can be covered
- In addition mounds or walls (buildings or sound barriers) around the air intake opening have proven to be successful. The sound reduction by shielding can be up to 20 dB(A) in the vicinity of the cooling tower.

3.6.2.3 Costs of noise reduction

Costs of noise attenuation measures will vary considerably depending on the type of measure and whether it is part of the design of a new cooling installation or of a measure taken during retrofitting an installation. For a new installation of a hybrid tower, total costs of the noise attenuation measures (fan, baffles) accounted for about 20% of the total investment.

An example was reported with respect to costs showing how costs can increase with increasing reduction of noise. For an axial fan different designs (value C and tip speed) could be applied without reducing pressure drop and flow/fan efficiency. In case of very low and super low noise fans, additional measures to the drive are required at extra cost.

Table 3.13: Example of cost increase with different fan design for reduced sound power level
Derived from [tm086, Van der Spek, 1993]

Fan design	Sound power level (dB(A))	Price-index
Classic	100	1
Low noise	95	1.5
Very low noise	90	3
Super low noise	85	4

The data in Table 3.13 just show cost differences for different fan designs, but costs for drive transmissions, sound attenuation and cooling tower construction should also be taken into account. The cost of primary measures such as super low noise fans may deliver at the same time distinctly lower operating costs due to lower power requirements. It can therefore not be unambiguously concluded that the sound reduction level would not be cost-effective.

3.7 Risk aspects associated with industrial cooling systems

3.7.1 Risk of leakage

[tm001, Bloemkolk, 1997]

3.7.1.1 Occurrence and consequences

Leakage can occur both in water and air cooling systems, but generally leakage is a concern of water cooled systems. In particular in once-through systems contamination will enter the aquatic environment immediately via the cooling water. In open and closed circuit wet and wet/dry systems this will not happen immediately, but leakage will contaminate the coolant and the chemistry of the coolant will be disturbed with consequences for the heat exchanging process. This effect of leakage on the working of oxidising and non-oxidising biocides has been clearly illustrated [tm090, Grab et al, 1994]. Finally, leaked process substances will be discharged with the blowdown.

In direct air cooling systems leakage may lead to contamination of the cooling air, but generally leakage is not considered to be an environmental problem of dry air-cooling. This leaves the responsibility of the operator unchanged to try and prevent leakage from dry cooling systems. Cooling systems using refrigerants are not within the scope of this document.

Heat exchangers are subject to corrosion, erosion and other forms of wear. Factors such as choice of material, fluid speeds, wall temperature and pressure levels influence this. As a result of this, leakage of process fluids and contamination of the coolant or contamination/disturbance of the process can occur. The type of cooler can also be a potential influence on the risk of leakage. In practice, an operation that is different from the one intended by design causes vibrations, and ultimately, leakage. Leakage becomes a relevant problem when the flow to be cooled contains components that are harmful to the environment. Leakage from condensers at power stations or condensers of evaporating plants are not considered to be a problem from a water quality viewpoint, but rather from a process-technical point of view. At power stations, leakage means a loss of vacuum in the condenser, which will lead to a loss of efficiency of the power generating process. With cooling in furnaces (steam generation) leakage of water can lead to explosions.

Product loss by leaching of heat exchangers can be important when, in a corrosive environment, (such as saltwater) relatively easily corroded material is used (for instance, copper condensers). Copper is often applied it reduces the chance of fouling, but in practice fouling is also found in copper condensers. Copper emissions are undesirable and can be prevented with better materials such as titanium and stainless steel or by adding anti corrosion compounds.

Leakage is also sometimes attributed to the 'sweating' of coolers. This concerns the presence of small hairline cracks or leaking of packing materials. The most common defects in heat exchangers, which are reported from actual practice, are caused by:

- corrosion/erosion as a result of chemical pollution (pit corrosion),
- corrosion resulting from biological foulings, chemicals, bacteria,
- mechanical erosion (due to cracks or vibrating mussels),
- vibrations (caused by flow or the resonance of external pumps, etc.),
- leaking, defective packing materials,
- sweating of 'rolled' tube-plate connections,
- dislodged tube-plate attachments,
- stress in materials as a result of incorrect operating pressure and/or temperature and
- temperature gradient of cooler too high; over 50° C can cause problems.

In once-through systems using large volumes, small leaks are hard to detect. In the case of cooling systems that contain several heat exchangers, there might always be a number of

defective heat exchangers, creating a more or less constant level of pollution in the cooling water, which is low and barely detectable in the large water flow. Larger levels of leakage can be detected, but generally this also means a considerable and significant emission. In recirculating systems with cooling towers, possible volatile compounds are stripped out and leakage is discharged in the blow down. In this case, because of the small volume of the discharge flow, detection is easier and the blowdown can be treated if necessary.

The magnitude of leakage usually becomes known as a result of incidents and to a limited extent by measurement in once-through systems. Larger leaks are detected and are usually immediately fairly significant. Data from actual cases have shown that levels of 100 to 3000 kg/24 hours with exit flows in mg/l are easily possible with large effluents (10000 m³/hour and more). The frequency of failures for different types of heat exchangers shows wide variation.

3.7.1.2 Reduction of leakage

Heat exchangers should be designed to prevent leakage. Different organisations have given recommendations regarding the nature of maintenance. This consists of a combination of preventive and corrective maintenance, because with prevention alone it has been shown that problems cannot be fully controlled. Preventive maintenance is often part of a production stop, once every two years. With corrective maintenance, a cooler is turned off and leaks are repaired, for instance by plugging a leaking tube or replacing a tube bank. For heat exchangers that cannot be turned off for production-technical reasons it is important that a second reserve cooler is available. It is becoming increasingly clear that "failure" and leaks are primarily caused by a fault in design. In the process industry, any extra costs of more expensive construction or better materials are usually easily outweighed by the costs of failure. Investment costs are low compared to those entailed by a loss of production. The design of heat exchangers should therefore take place on a basis of "forecast availability".

The following general measures to reduce the occurrence of leakage can be applied:

- select material for equipment of wet cooling systems according to the applied water quality;
- operate the system according to its design;
- if cooling water treatment is needed, select the right cooling water treatment program;
- monitor leakage in cooling water discharge in recirculating wet cooling systems (blowdown).

If problems arise in practice, there are a number of options, partially dependent on the cause:

At component level (the heat exchanger):

- check causes of erosion, corrosion
- check operating conditions vs. design conditions
- replace cooler by improved type, checking the construction and material
- drainage of flow polluted by leakage to purification (purification of sub-flow concerned)
- recirculation of cooling the water flow of the cooler concerned over either an air cooler, and/or indirect water cooling (this option naturally does not remedy production failure resulting from failure of the cooler).

At a system level (the complete cooling water system or parts thereof):

- maintain as small a pressure difference as possible between the cooling water and the process water, or create or maintain overpressure in the cooling water
- convert to an indirect system or if technically possible convert to a recirculating system with cooling tower (taking into account potential volatilisation of components).

The VCI safety concept, applied by the chemical industry, refers to leakage as the temporary discharge of substances causing long-term detrimental changes to water bodies. To prevent and control this the chemical process substances are rated (using the R-phrases) and the final rating is linked to requirements concerning selection of the (indirect) cooling configuration system and the way leakage is monitored (see Annex VII).

It is obvious that the application of an indirect completely system or a recirculating system with a cooling tower can control leakage almost 100%. Only if system pressure drops can fouled water be released, but this flow is small and controllable. Application of both options however, needs awareness of the requirements of the process to be cooled. An indirect design or application of a cooling tower will increase the approach and raise the minimum end temperature of the process substance. If the process to be cooled can tolerate this, the characteristics of the process substance(s) may justify an indirect design to protect the receiving surface water against any unwanted emission due to leakage.

Some companies consciously use a cooling system in which parts that are subject to leakage are provided with indirect cooling, and those that are not subject to leakage are not. As the control of leakage appears to be difficult, in cooling priority substances or other environmentally hazardous products, once-through systems should preferably not be used, especially in view of the alternatives available.

For an existing cooling system an indirect design generally is neither technically nor economically the most applicable solution. Practical experience with the application of a solid maintenance and control programme to a large once-through cooling system using seawater has given good results. Some cooler replacements were necessary, but 90% of the failure of the different heat exchangers could be reduced by proper antifouling treatment and operating care (vibration monitoring, pump handling and care with flow pinching). Leakage detection is applied and, by detecting at the right places, the time between heat exchanger leakage and detection can be shortened.

Detection of leakages in once-through systems is difficult, but a recommended starting point is the identification of the heat exchangers that are prone to leakage and that cool harmful substances. More selective and accurate measurement of leakage will then be possible. Preventive and corrective maintenance are both important to overcome leakage problems, but proper design generally tends to be most cost-effective.

3.7.1.3 Reduction by preventive maintenance

Visual inspection, hydrostatic testing and additional investigation on pulled tubes are examples of former inspection methods. The limitations of these methods were that the inspection was concentrated on the directly visible parts of the tubes. Dirt often masks the early stages of defects and uniform corrosion is hard to see with the naked eye. Hydrotesting only detects leaking tubes. The question is how to select a representative tube for further investigation. As a consequence the former inspection methods described above could not prevent environmental pollution due to unexpected leakage, breakdown, reduction in capacity and/or occurrence of off-spec product. On the other hand a great number of spare tubes had to be in stock for unexpected retubing.

Experiences with a new kind of investigation of heat exchanger tubes (by means of eddy current investigation) have shown that the reliability of heat exchanger tubes can be increased significantly and that emissions due to leakage can be reduced. Because this method is capable of testing a single tube and giving a prediction of failure of a single tube, the inspection frequency will be based on facts. As a consequence, inspection methods capable of predicting the risk of failure of individual tubes of a heat exchanger can lead to a reduction of tube consumption, better stock management and knowledge about corrosion behaviour in early

stages. This will lead to a reduction of unexpected breakdowns due to leaking tubes with the environmental benefit of a reduction of emissions via the cooling water.

Application of this method at the site of a chemical plant has resulted in a reduction of more than 90 % of the percentage of retubing since introducing this method in 1990 [Paping, Dow Chemical Benelux Terneuzen, 1999]. This has also resulted in a reduction in annual costs. The average annual savings due to the reduction of number of pipes to be retubed are about 5 times as high as the inspection costs. The number of unexpected process breakdowns due to leaking tubes has been reduced by 90 % over the last 10 years.”

3.7.2 Storage and handling of chemicals

The storage and handling of chemicals is potentially an environmental issue of wet cooling systems. Dosage of cooling systems additives can be continuous or intermittent and the chemicals can be fed diluted or neat. The amounts of chemical and its characteristics vary greatly and depend on a range of factors (e.g. water chemistry and heat exchanger material): the risk due to storage and handling will vary accordingly.

For example, for pH control, concentrated sulphuric acid is used and this is usually stored in mild steel tanks. Proper ventilation is required to prevent the build-up of explosive hydrogen gas in the storage tank. Strainers upstream of acid pumps are advisable to remove any residual corrosion products or other solids that may be present in the storage tank.

Sometimes additives are produced on-site. For example, hypochlorite can be produced on marine sites by electrolysis of seawater. This process called electrochlorination can be dangerous for the potential of chlorine gas formation. Also, the installation needs frequent cleaning using acids. Alternative treatments are applied, where possible to avoid these risks (e.g. Annex XI.3.4.7).

Cooling additives can be fed by the operator manually or by means of sophisticated computer controlled systems or can be outsourced to specialised firms, usually the actual supplier of the additives. Feeding manually has a higher risk of spilling, and for environmental and human health reasons safe handling procedures should be applied. Automated systems run a risk of being neglected, but require regular inspection.

In the EU specific regulations on transport, storage or handling of chemicals have to be observed and environmental permits require site-specific measures. Generally, the aim is to reduce the risk of spilling and leakage to prevent soil and/or ground water contamination and to reduce the risk of explosions by defining a restricted area where storage and handling of chemicals is allowed. Such areas are equipped with impermeable floors or grid floors with a bund, with segregation to keep reactive chemicals separate and with a minimum required ventilation rate.

BAT measures for the storage of dangerous substances are described in the BREF concerning emissions from storage.

3.7.3 Microbiological risk

3.7.3.1 Occurrence of microbes

Microbiological risks from cooling systems relate to the occurrence of different species of pathogens in cooling water or in parts of the system that are in contact with the cooling water, such as biofilms in heat exchangers and fill in cooling towers. These risks are not an issue in dry cooling systems.

The major thermophilic pathogens that are found in wet cooling systems using river waters are the bacteria *Legionella pneumophila* (*Lp*) and the amoeba *Naegleria fowleri* (*Nf*). In marine waters some halophilic vibrios species, pathogenic for fish or man, can develop in once-through cooling systems. The species mentioned occur in the natural environment in generally low and harmless concentrations. Due to the raised temperature a favourable climate can occur in cooling systems enhancing the development of those bacteria, which can create a potential risk for human health. Development of *Legionella* is enhanced by fouling, presence of amoeba, ciliates and algae. It is spread through aerosols. Following some large outbreaks the occurrence and characteristics of Legionnaire's disease (LD) and the development of *Lp* has been widely researched from a medical/biological point of view. But many points relating to the chemical and process technology remain unclear.

In the plume of a natural draught wet cooling tower with a considerable height and with a good functioning drift eliminator, the emission of bacteria is of less importance, but not impossible. A high concentration of *Lp* in the plume of a natural draught wet cooling tower has been reported due to fouling on the inside of the concrete cooling tower wall. The layer had been released from the wall and fallen onto the drift eliminator [tm145, Werner and Pietsch, 1991].

The appearance of *Lp* in the plume of industrial mechanical draught cooling towers, which have a much lower height than natural draught towers, has been reported on a number of occasions [tm040, Schulze-Robbecke and Richter, 1994], but a clear cause and effect relation between cooling towers and an LD outbreak could not be established. Where a relation between cooling systems and an outbreak of LD could be made it always concerned badly maintained systems [Morton et al., 1986].

Typical conditions in wet cooling towers that enhance the development of *Legionella* are:

- the water temperature in the cooling tower is between 25 and 50 degrees centigrade;
- the pH between 6 and 8;
- the presence of fouling.

Less information was submitted on the occurrence and treatment of other pathogens such as *Nf*. It has been observed that development of *Nf* is inhibited by brass and enhanced by stainless steel. The amoebae are also more abundant in open recirculating cooling systems than in once-through cooling systems. Research was carried out on the treatment of *Nf* after increased levels in plant cooling water (3000 l⁻¹) followed replacement of condensers in a French power station. Continuous chlorination with a maximum free residual chlorine level in the range of 0.3-0.5 mg/l decreased concentrations of *Nf* immediately and the levels remained under 4 pathogens/l. [tm 144, Cabanes et al, 1997].

3.7.3.2 Measuring of bacteriae

Lp-bacteria are measured in colony forming units or CFU per litre and are reported to vary in concentration in cooling tower water from very low (down to 10 CFU/l) to very high (10⁵-10⁶ CFU/l). In biofilms *Lp* has been found in concentrations of up to 10⁶ CFU/cm².

For air conditioning systems, values of 100-1000 CFU are applied in the UK, but it is not clear if this can be compared to the levels in well-maintained wet cooling towers and the associated risk in those situations. A recommendation was made to keep the concentration of *Lp* below 10⁴ CFU/l. Quantification of representative concentrations of *Lp* in industrial wet cooling systems and the level of CFU in wet cooling towers that is still acceptable with respect to human health may require further research.

3.7.3.3 Techniques to reduce microbiological risks

([038, Millar et al., 1997] and [tm040, Schulze-Robbecke and Richter, 1994], [tm166, Morton et al, 1986] [tm167, Fliermans, 1996],)

The chain of events to create an outbreak of *Legionella* involves:

- the development of a virulent strain of bacteria in the cooling system
- conditions that enhance the multiplication of bacteria
- contaminated water discharged to the atmosphere as aerosol
- sufficient droplets deeply inhaled by susceptible persons

Prevention of *Legionella* should therefore be based on prevention of development and multiplication of bacteria in the cooling system. Particularly in the USA and UK recommendations have been developed for prevention of LD. Regular analysis of the potential reservoir (e.g. cooling tower), and additional routine maintenance, proper pH and temperature levels, adequate levels of residual biocides, and control on quality of the makeup water can prevent the occurrence of environments that encourage *Legionella*.

On the prevention of formation of *Lp*-bacteria (and others) in cooling towers, the following measures should be applied:

- use clean water and pretreat the cooling water if possible;
- avoid process leakage into the cooling system;
- avoid stagnant zones;
- prevent formation by reduction of light energy within the cooling tower avoiding algae formation; open water basins are to be avoided;
- easy access for regular cleaning should be provided;
- use of drift eliminators that can be easily cleaned or replaced;
- design cold water temperature as low as possible (small approaches);
- avoid scale and corrosion;
- optimisation of construction to enhance the right water velocity and air speed;
- a minimum distance of the CT from populated areas is impossible to give, but consideration should be given to avoiding the plume reaching ground level or reaching populated areas, if space allows;
- minimisation of plume formation could restrict the spread.

With respect to the location of a cooling tower a rating has been suggested of the microbiological risk associated with a cooling tower based on the host population and the potential susceptibility of the host. The rating categories are:

- Category 1: highest risk – cooling tower serving or in the vicinity (<200 m) of a hospital, nursing home or other health care facility caring for persons who may be immunologically compromised;
- Category 2: cooling tower serving or in the vicinity (>200 m) of a retirement community, hotel or other buildings accommodating a large number of people are localised;
- Category 3: cooling tower in a residential or industrial neighbourhood;
- Category 4: lowest risk – cooling tower isolated from residential neighbourhood (>600 m from residential area).

Based on this rating, inspection for the presence of *Legionella* ranges from monthly (highest risk), monthly to quarterly (Cat. 2), quarterly to yearly (Cat. 3) to once a year after summer (Cat. 4).

The following measures are recommended to operators of cooling towers:

- care must be taken in case of process stops and start-ups, especially if the cooling circulation system is down for more than 4 days;
- operators entering cooling towers should avoid inhaling the air by using mouth and nose protection (P3-mask has been proven);
- If cleaning a cooling system after *Lp* has been detected, a combination of mechanical cleaning and a shock-dosage of a biocide.

Some additional remarks on these recommendations can be made. After a prolonged shutdown it is imperative to treat cooling systems with a biocide (chlorine). If there is evidence of a dirty or contaminated system, including accessories such as sound attenuation, it must be cleaned and receive biocide shock treatment prior to start-up. A competent water treatment company should conduct such treatment. Disinfection of the system may be needed if the system is heavily contaminated.

From experience it is clear that chemical treatment mainly treats the bacteria in the water. To control and clean the cooling system more thoroughly attention must be paid to sediments and fouling on the cooling system surface, hence the importance of mechanical cleaning.

The level of free chlorine of 50 mg/l mentioned in the literature is clearly a shock dosage level that has been applied after an outbreak of LD. Because of the large amount of hypochlorite involved, it is clear that this treatment is not appropriate as maintenance level in a cooling tower. In any case, after shock dosing, detoxification of the treated cooling water would be necessary before discharge and treatment with bisulphite has been commonly applied.

A high maintenance level to prevent *Lp*-development as much as possible is to be favoured. In general, oxidising biocides are favoured for killing the *Legionella* in the water. Slower acting agents are needed to attack bacteria in the biofilms. This would then require treatment with non-oxidising biocides. Of these the QACs have shown better results than the isothiazolines.

In a recent Dutch report [tm155, Berbee, 1999] some results on reducing the CFU-level in cooling towers were reported which confirmed that a clear minimum concentration level of biocides has not yet determined. It was concluded that high levels of biocide were needed to reduce-concentrations, but only showed a temporary effect. The side effect of elevated levels of toxic by-products must be realised. Lower water temperature appeared to be more effective than application of biocides (Table 3.14), but this may not be applicable in every case. Investigations into the effect of treatment of the protozoa revealed that very high concentrations are needed to kill the protozoa and that cysts are hardly susceptible to the applied non-oxidising biocides.

Table 3.14: Effects of temperature and biocide treatment on CFU-levels in cooling towers
Quoted from Kusnetsov by [tm155, Berbee, 1999]

Cooling tower	Effect of lower Temp	Biocide conc. (mg/l)	Effect of biocide	Remarks
A	T 25°C~10 ⁵ CFU to T 15°C~10 ³ CFU	PHMB, 3, shock	Temporarily under detection limit	
B	T 25°C~10 ⁴ CFU To T 15°C~10 ³ CFU	BNPD, 5, shock	Temporarily under detection limit	
C	n.r.	PHMB, 2-250, Shock	Not clear	Change to tapwater
D	n.r.	PHMB, 4-11, Shock	Temporarily, 10 ⁴ CFU/l to 10 ³ CFU/l	
E	n.r.	BNPD, 65-190, shock	Temporarily, 10 ⁵ CFU/l to 10 ³ CFU/l	
Notes: PHMB: polyhexamethylenbiguanidechloride (QAC) BNPD: bromonitropropanediol				

3.8 Waste from cooling system operation

Little has been reported on the wastes or residues from cooling systems operation. For all cooling systems, decommissioning of part or all of system can be an issue at some stage. Retrofitting and replacement of equipment as well as the operating methods result in the following wastes to be disposed of:

- sludge from pre-treatment of intake water (e.g. decarbonisation), treatment of cooling water or blowdown from the operation of recirculating wet cooling towers (see Annex XI 3.4);
- hazardous waste (e.g. small containers, spillage) associated with the chemical treatment of cooling water in wet cooling systems;
- waste water of cleaning operations;
- wastes as a result of retrofitting, replacing or decommissioning of the installation.

3.8.1 Formation of sludges

Sludge formation can occur in the collecting basins of wet cooling systems. In quantitative terms, more sludge results from the decarbonisation process, if this is practised on site. No particular measures have been reported on reducing the formation of sludge. Appropriate cooling water conditioning is likely to reduce settlement of sludge. Currently, chemical composition of the sludge and the local (or national) legislation will determine the disposal method for sludges. In some Member States sludges can be returned to the surface water of origin, but in others they have to be treated in more strictly defined ways.

Sludges and mud deposited on the bottom of water basins of cooling towers can contain cysts or resistance forms of pathogenic bacteria and protozoa (3.7.3). Pathogenic amoebae and *Legionella pneumophila* are found at very high concentrations in sludge collected from condenser tubes during downtime or in clarifying iron chloride sludge [tm145, Werner and Pietsch, 1991]. Cysts of *Lp* are also found in the scale on the fill. As a consequence it is recommended that the microbiological quality of this type of residue be surveyed prior to the disposal or the reprocessing of PVC fills. A special treatment may be required if the handling and reprocessing of these wastes cause a significant health risk.

3.8.2 Residues from cooling water treatment and cleaning operations

Treatment of cooling water (especially for larger systems) nowadays is automatic and in many cases the substances are kept in containers and tanks and are applied stored, transported and handled by the supplier.

The same applies to waste water resulting from cleaning operations. Here too, more and more specialised companies are contracted to do this work.

The generation and disposal of this type of waste however is not typical for industrial cooling systems. The extent to which it represents an environmental problem is closely related to the way in which the cooling system is operated, to pre-treatment of the intake water and to the efficiency of the cooling water treatment. No information has been submitted on this environmental issue.

3.8.3 Residues as a result of retrofitting, replacing and decommissioning of the installation

Generally, cooling systems are designed and built for a long service life (up to 20 years and more). Obviously, the better the way they are operated and maintained the longer their operational life, but they should also be designed and built for the particular circumstances in which they are to be used. Particular materials should also be considered for their environmental

impact when applying, decommissioning or replacing parts of a cooling system. The following examples were reported.

3.8.3.1 Use of plastics

Increasingly, different kind of plastics are applied for cooling tower construction, such as polyvinylchloride, polypropylene, polyethylene and glass reinforced plastics. Their characteristics make them highly suitable for application in the often corrosive, highly demanding environment of a cooling tower. Current experiences have been described in a technical paper of the German Organisation of Power Plant Operators [tm., VGB, 2000]. The use of plastics may be an opportunity for waste reduction, if there is a possibility of recycling after replacement of plastic elements. No experiences have yet been reported that could illustrate this.

3.8.3.2 Treatment of timber used for wet cooling tower construction

Timber has been and is used for cooling towers, but has to be treated to ensure its longevity. Timber used in cooling towers for both packing and support structures can be chemically treated. Treatment has been and still can be based on CCA (copper sulphate, potassium dichromate and arsenic pentoxide), because of its ability to remain bound to the timber. It is claimed that over its operating life only 10% by weight is lost.

Quantification of the extent to which emissions from CCA-treated timber occur into the aquatic environment cannot be quoted. It has been reported that treated timber, although it has time to drain, still has considerable amounts of chemicals on the wood surface. They may be washed off in the initial flush of water in the cooling tower and will be sooner or later be discharged into the receiving water.

Because CCA contains Cr and As, it seems unlikely that will continue to be used for much longer. CCA treatment of timber is not a best available technique and is expected to be banned. Alternative treatments for protection of timber have already been developed and applied. It is therefore expected that emissions into the surface water resulting from CCA will gradually reduce.

If CCA-treated wood has to be disposed of - some countries allow controlled disposal in an appropriate landfill site - as low leaching is expected. In other Member States incineration in an appropriate installation is preferred, where most of the elements will be retained in the dustfilter. Determining the most favourable technique for dispose of the CCA-treated timber is beyond the scope of this BREF-document, but also here the final environmental impact of the different options needs to be evaluated here.

3.8.3.3 Wet cooling tower fill

As soon as cooling tower fill needs to be replaced it will have to be disposed of. Fills are made of different materials and this will determine the way in which they will have to be treated. No data on polluting levels of fill have been reported.

A special case is the use of asbestos paper fill. It has not been possible to assess whether this has been practised in Europe, but asbestos may have been used in many applications in the past, including cooling tower construction or cooling tower fill. As the hazards of the use of asbestos are no longer in doubt, it is no longer used in cooling towers. In old cooling towers some asbestos may still be found and special measures are required to remove it.

One reference reported an example in which crumbling of asbestos fill occurred over a period of 10-17 years of operation, causing reduced heat exchange. Removal and replacement of the fill were necessary under severe safety conditions [tm082, Mittendorf, 1990].

4 BEST AVAILABLE TECHNIQUES FOR INDUSTRIAL COOLING SYSTEMS

4.1 Introduction

In understanding this chapter and its contents, the attention of the reader is drawn back to the preface of this document and in particular the fifth section of the preface: “How to understand and use this document”. The techniques and methods and associated emission and/or consumption levels, or ranges of levels, presented in this chapter have been assessed through an iterative process involving the following steps:

- identification of the key environmental issues for the process; emphasis in the process of cooling is clearly on energy efficiency increase (increase of the overall energy efficiency of the process), on the reduction of emissions to surface water by optimization of cooling water conditioning;
- examination of the techniques most relevant to address those key issues;
- identification of the best environmental performance levels, on the basis of the available data in the European Union and world-wide; in most cases performance levels are considered as installation specific.
- examination of the conditions under which these performance levels were achieved; such as costs, cross-media effects, main driving forces involved in implementation of this techniques; generally, price indications of techniques in cooling systems have been reported to a very limited extent;
- selection of the best available techniques (BAT) and the associated emission and/or consumption levels for this sector in a general sense all according to Article 2(11) and Annex IV of the Directive.

Expert judgement by the European IPPC Bureau and the relevant Technical Working Group (TWG) has played a key role in each of these steps and in the way in which the information is presented here.

On the basis of this assessment, techniques, and as far as possible emission and consumption levels associated with the use of BAT, are presented in this chapter that are considered to be appropriate to the relevant cooling systems and in many cases reflect current performance of some installations applied. Where emission or consumption levels “associated with best available techniques” are presented, this is to be understood as meaning that those levels represent the environmental performance that could be anticipated as a result of the application, under the process and site-specific conditions, of the techniques described, bearing in mind the balance of costs and advantages inherent within the definition of BAT. However, they are neither emission nor consumption limit values nor minimum required performance levels and should not be understood as such. In some cases it may be technically possible to achieve better emission or consumption levels, but due to the costs involved or cross-media considerations they are not considered to be appropriate as a BAT for the relevant cooling configuration. However, such levels or applications may be considered to be justified in more specific cases where there are special driving forces.

The emission and consumption levels associated with the application of BAT have to be seen together with any specified reference condition (e.g. climate, site limitations).

The concept of “levels associated with BAT” described above is to be distinguished from the term “achievable level” used elsewhere in this document. Where a level is described as “achievable” using a particular technique or combination of techniques, this should be understood to mean that the level may be expected to be achieved over a substantial period of time in a well maintained and operated installation or process using those techniques.

Where available, data concerning costs have been given together with the description of the techniques presented in the previous chapter or the Annexes. These give a rough indication about the magnitude of costs involved. However, the actual cost of applying a technique will depend strongly on the specific situation regarding, for example, taxes, fees, and the technical characteristics of the installation concerned. It is not possible to evaluate such site-specific factors fully in this document. In the absence of data concerning costs, conclusions on economic viability of techniques are drawn from observations on existing installations.

It is intended that the general BAT in this chapter are a reference point against which to judge the current performance of an existing installation or to judge a proposal for a new installation. In this way they will assist in the determination of appropriate "BAT-based" conditions for the installation or in the establishment of general binding rules under Article 9(8). It is foreseen that new installations can be designed to perform at or even better than the general BAT levels presented here. It is also considered that existing installations could move towards the general BAT levels or do better, subject to the technical and economic applicability of the techniques in each case.

While the BREFs do not set legally binding standards, they are meant to give information for the guidance of industry, Member States and the public on achievable emission and consumption levels when using specified techniques. The appropriate limit values for any specific case will need to be determined taking into account the objectives of the IPPC Directive and the local considerations.

4.2 A horizontal approach to defining BAT for cooling systems

Before summarising the BAT conclusions in this chapter, a short explanation is given on how the horizontal character of this BREF should be interpreted.

In a horizontal approach it is assumed that the environmental aspects of the applied techniques and the associated reduction measures can be assessed and that generic BAT can be identified that are independent of the industrial processes in which techniques are applied.

Industrial cooling systems are an integrated part of the industrial process to be cooled. The cooling systems within the scope of this document are used in many of the industrial sectors under the scope of IPPC. Consequently, the variety of applications, techniques and operational practices is enormous. Additionally, the thermodynamic character of the process leads to further variations in performance and consequently in the environmental effects.

Due to this large variation, comparisons between techniques leading to general conclusions on BAT are difficult. The identification of a general preventive approach is considered to be possible, based on practical experience with reduction of emissions from cooling systems.

In this preventive approach or, **primary BAT-approach**, attention is firstly given to the process to be cooled. The design and the construction of the cooling system are an essential second step, in particular for new installations. Finally, changes of equipment and the way in which the cooling system should be operated will address new installations, but are particularly important in existing systems, where technological options are considerably limited and cost-intensive. Careful evaluations must be performed case by case.

4.2.1 Integrated heat management

4.2.1.1 Industrial cooling = Heat management

Cooling of industrial processes can be considered as heat management and is part of the total energy management within a plant. The amount and level of heat to be dissipated requires a certain level of cooling systems performance. This performance level will in turn affect the system configuration, design and operation and consequently the cooling systems' environmental performance (direct impact). Reversibly, the cooling performance will also affect the overall efficiency of the industrial process (indirect impact). Both impacts, direct and indirect, need to be balanced, taking into account all variables. Every change in the cooling system has to be considered against the consequences it may have for this balance.

This concept can be used as a starting point to formulate the first principle of BAT for cooling systems. **BAT for all installations** is an integrated approach to reduce the environmental impact of industrial cooling systems **maintaining the balance between both the direct and indirect impacts**. In other words, the effect of an emission reduction has to be balanced against the potential change in the overall energy efficiency. There is currently no minimum ratio in terms of the environmental benefits and the possible loss in overall energy efficiency that can be used as a benchmark to arrive at techniques that can be considered BAT. Nevertheless, this concept can be used to compare alternatives (Chapter 3.2 and Annex II).

4.2.1.2 Reduction of the level of heat discharge by optimization of internal/external heat reuse

A preventive approach should start with the industrial process requiring heat dissipation and aim to reduce the need for heat discharge in the first place. In fact, discharge of heat is wasting energy and as such not BAT. Reuse of heat within the process should always be a first step in the evaluation of cooling needs. Process-integrated energy measures are outside the scope of this document, but reference is made to other BAT Reference Documents drafted in the framework of IPPC describing options for energy measures.

In a **greenfield** situation, assessment of the required heat capacity can only be BAT if it is the outcome of **maximum use of the internal and external available and applicable options** for reuse of excess heat.

In an **existing installation**, **optimizing internal and external reuse** and reducing the amount and level of heat to be discharged must also precede any change to the potential capacity of the applied cooling system. Increasing the efficiency of an existing cooling system by **improving systems operation** must be evaluated against an increase of efficiency by technological measures through retrofit or technological change. In general and for large existing cooling systems, the improvement of the systems operation is considered to be more cost effective than the application of new or improved technology and can therefore be regarded as BAT.

4.2.1.3 Cooling system and process requirements

Once the level and amount of waste heat generated by the process is established and no further reduction of waste heat can be achieved, an initial selection of a cooling system can be made in the light of the process requirements discussed in Chapter 1. Every process has its unique combination of requirements, where the level of control of the process, process reliability and safety play an important role. This makes it almost impossible at this stage to make a first characterisation of BAT, but the following conclusions can be drawn with respect to a number of process characteristics.

The application of the ambient temperature levels is based on the experiences in Europe in applying cooling systems under different climatic conditions. Generally, dry bulb temperatures do not justify cooling away low level waste, heat and water-cooling is preferred. But in areas with low average dry bulb temperatures dry air-cooling is applied to cool down to lower process temperatures (after options for reuse have been explored). Water-cooling, if sufficient water is available, can then dissipate the residual amount of waste heat.

Hazardous process substances, which involve a high environmental risk to the aquatic environment in case of leakage, should be cooled by means of indirect cooling systems to prevent an uncontrollable situation.

The selection of a cooling configuration should be based on a comparison between the different feasible alternatives within all requirements of the process. Process requirements are for example control of chemical reactions, reliability of process performance and maintenance of required safety levels. The aim is to minimise the indirect impact of the selected alternative. For each alternative the environmental performances can be best compared if expressed in direct and indirect use of energy (kW_e) per unit of energy discharged (kW_{th}). Another way to compare configurations is to express the change in direct energy use (kW_e) of the cooling system and the change in production level of the process in tonnes, both per unit of energy discharged (kW_{th}).

A change in cooling technology to reduce the environmental impact can only be considered BAT if the efficiency of cooling is maintained at the same level or, even better, at an increased level.

Table 4.1: Examples of process requirements and BAT

Process characteristics	Criteria	Primary BAT approach	Remark	Reference
Level of dissipated heat high (> 60°C)	Reduce use of water and chemicals and improve overall energy efficiency	(Pre-) cooling with dry air	Energy efficiency and size of cooling system are limiting factors	Section 1.1/1.3
Level of dissipated heat medium (25-60°C)	Improve overall energy efficiency	Not evident	Site-specific	Section 1.1/1.3
Level of dissipated heat low (<25°C)	Improve overall energy efficiency	Water cooling	Site selection	Section 1.1/1.3
Low and medium heat level and capacity	Optimum overall energy efficiency with water saving and visible plume reduction	Wet and hybrid cooling system	Dry cooling less suitable due to required space and loss of overall energy efficiency	Section 1.4
Hazardous substances to be cooled involving high environmental risk	Reduction of risk of leakage	Indirect cooling system	Accept an increase in approach	Section 1.4 and Annex VI

4.2.1.4 Cooling system and site requirements

The site-imposed limits apply particularly to new installations, where a cooling system must still be selected. If the required heat discharge capacity is known it may influence the selection of an appropriate site. For temperature-sensitive processes it is BAT to select the site with the required availability of cooling water.

For many reasons new installations are not always erected on a site that is preferred from a cooling technology point of view, whereas for both new and existing installations the site characteristics are clear once the site is known. The most important thermodynamic characteristic of a site is its annual climatic pattern described by the dry and wet bulb temperatures.

Table 4.2: Examples of site characteristics and BAT

Characteristics of site	Criteria	Primary BAT approach	Remarks	Reference
Climate	Required design temperature	Assess variation in wet and dry bulb T	With high dry bulb T dry air cooling generally has lower Energy efficiency	Section 1.4.3
Space	Restricted surface on-site	(Pre-assembled) Roof type constructions	Limits to size and weight of the cooling system	Section 1.4.2
Surface water availability	Restricted availability	Recirculating systems	Wet, dry or hybrid feasible	Section 2.3 and 3.3
Sensitivity of receiving water body for thermal loads	Meet capacity to accommodate thermal load	<ul style="list-style-type: none"> - Optimise level of heat reuse - Use recirculating systems - Site selection (new cooling system) 		Section 1.1
Restricted availability of groundwater	Minimisation of groundwater use	Air cooling if no adequate alternative water source is available	Accept energy penalty	Section 3.3
Coastal area	Large capacity $> 10 \text{ MW}_{\text{th}}$	Once-through systems	Avoid mixing of local thermal plume near intake point, e.g. by deep water extraction below mixing zone using temperature stratification	Section 1.2.1 / Section 3.2 / Annex XI.3
Specific site requirements	In case of obligation for plume reduction and reduced tower height	Apply hybrid cooling system	Accept energy penalty	Ch.2

Other characteristics identified are space, water availability to cool and to discharge and the surrounding sensitive areas (urban and industrial). With respect to groundwater, it can be BAT to apply a dry cooling system following the principle to minimise the use of groundwater, particularly in those areas where depletion of aquifers cannot be ruled out.

In Table 4.2 BAT examples are shown that have been identified for a few site characteristics.

4.2.2 Application of BAT in industrial cooling systems

In Chapter 1 the outline of a preventive approach is presented showing how a step-by-step evaluation of all constraints can lead to what may be called “Best available cooling technique”. Within the framework of this approach, Chapter 1 and Chapter 3 and the associated Annexes discuss the factors and offer techniques involved in the identification of potential BAT for the major cooling configurations using water and/or air. The optimization of a cooling system to reduce its environmental impact is a complex exercise and not an exact mathematical comparison. In other words, combining techniques selected from the BAT-tables does not lead to a BAT cooling system. The **final BAT solution** will be a **site-specific solution**. However, it is believed that, based on experience in industry, conclusions can be drawn on BAT, in quantified terms where possible.

In Chapter 3 options for reducing emissions into the environment have been presented based on the information submitted by the TWG. For each environmental issue and for each relevant cooling configuration an attempt has been made to identify a general approach and arrive at BAT. Some techniques are described in more detail in the Annexes. Emphasis is clearly on the water-related problems with a focus on reduction of the application of biocides and blacklisted substances.

The proposed techniques are applied techniques. They have proven to be effective, although quantification is difficult and they may create unrealistic expectations. It can be assumed that all measures proposed as BAT, and which are not entirely dependant on the local situation, can be considered for new systems. With respect to existing installations, care must be taken as the assessment is more difficult where options are limited and depend on a multitude of (process) factors. There do not seem to be many obstacles to implementation of operational measures in existing cooling systems, unless the technological design limits the number of options for modification.

In Tables 4.3 to 4.12 techniques are presented that are considered BAT, following on from the primary BAT-approach for:

- increasing the overall energy efficiency,
- reduction of use of water and of cooling water additives,
- reduction of emissions to air and water,
- reduction of noise,
- reduction of entrainment of aquatic organisms and
- reduction of biological risks.

No clear BAT has been identified on the reduction of waste or techniques to handle waste avoiding environmental problems, such as contamination of soil and water, or air in the case of incineration.

For each environmental issue the consequences for other media of the application of a reduction technique have been identified. Generally speaking every change made to a cooling system must be carefully balanced against the associated effects and in this sense the optimisation of industrial cooling is a cross-media issue.

For some measures BAT-values have been identified. However, addressing the application of different cooling techniques in a multitude of varying process conditions does not allow for clear associated levels. In those cases a qualitative description is given.

For **new cooling installations** it is BAT to start identifying reduction measures in the design phase, applying equipment with low energy requiring requirement and by choosing the appropriate material for equipment in contact with the process substance and/or the cooling water. In this sense the following quotation is exemplary: “in practice... attention to design, layout and maintenance of the cooling water system has a relatively low priority compared to the environmental consequences of a poorly designed and/or operated cooling water system. Since little attention is paid to design factors, treatments often have to make up for bad design, and therefore need to be chosen in such a way that they minimize risks of fouling. Few changes of this attitude are to be expected as long as there is a low level of awareness of the long-term costs of operating and maintaining poorly designed CWS” [tm005, Van Donk and Jenner, 1996].

If dry air cooling systems are the preferred option, measures are primarily related to reduction of direct energy consumption and noise emissions and the optimization of size with respect to the required cooling surface.

For **existing installations**, technological measures can be BAT under certain circumstances. Generally, a change in technology is cost-intensive where overall efficiency must be maintained. Cost evaluation should then compare investment costs of the change versus the change in operational costs and validate the reduction effect versus other environmental consequences. For example, it would need a comparison between the environmental effect of recirculating the cooling water - requiring the application of biocidal water treatment - against a once-through system without biocides, but a large heat emission to the aquatic environment.

In the case of pre-assembled off-the-peg cooling towers, a change in technology seems feasible both technically and economically. No comparable data have been submitted that can support this, but supplier experience is that it is relatively easy to change small size cooling towers, for example, from a closed recirculating wet to a closed recirculating hybrid or wet/dry configuration. This would not need major process modifications or constructionwork. For large custom-designed towers that are erected on-site, technological changes are not easy to make. A different technology generally means a completely new cooling tower.

For existing wet cooling systems, where the focus is largely on environmental measures to reduce water use and to emissions of chemicals to the surface water, BAT has not so much technological but rather an operational character. Monitoring, operation and maintenance are the key issues here.

4.3 Reduction of energy consumption

4.3.1 General

It is BAT in the design phase of a cooling system:

- To reduce resistance to water and airflow
- To apply high efficiency/low energy equipment
- To reduce the amount of energy demanding equipment (Annex XI.8.1)
- To apply optimised cooling water treatment in once-through systems and wet cooling towers to keep surfaces clean and avoid scaling, fouling and corrosion.

For each individual case a combination of the above-mentioned factors should lead to the lowest attainable energy consumption to operate a cooling system. Concerning BAT a number of techniques/approaches have been identified.

4.3.2 Identified reduction techniques within the BAT-approach

In an integrated approach to cooling an industrial process, both the direct and indirect use of energy are taken into account. In terms of the overall energy efficiency of an installation, the use of a once-through systems is BAT, in particular for processes requiring large cooling capacities (e.g. > 10 MW_{th}). In the case of rivers and/or estuaries once-through can be acceptable if also:

- extension of heat plume in the surface water leaves passage for fish migration;
- cooling water intake is designed aiming at reduced fish entrainment;
- heat load does not interfere with other users of receiving surface water.

For power stations, if once-through is not possible, natural draught wet cooling towers are most energy-efficient than other cooling configurations, but application can be restricted because of the visual impact of their overall height.

Table 4.3: BAT for increasing overall energy efficiency

Relevance	Criterion	Primary BAT approach	Remarks	Reference
Large cooling capacity	Overall energy efficiency	Select site for once-through option	See text above table	Section 3.2
All systems	Overall energy efficiency	Apply option for variable operation	Identify required cooling range	Section 1.4
All systems	Variable operation	Modulation of air/ water flow	Avoid instability cavitation in system (corrosion and erosion)	
All wet systems	Clean circuit/ exchanger surfaces	Optimised water treatment and pipe surface treatment	Requires adequate monitoring	Section 3.4
Once-through systems	Maintain cooling efficiency	Avoid recirculation of warm water plume in rivers and minimise it in estuaries and on marine sites		Annex XII
All cooling towers	Reduce specific energy consumption	Apply pumping heads and fans with reduced energy consumption		

4.4 Reduction of water requirements

4.4.1 General

For new systems the following statements can be made:

- In the light of the overall energy balance, cooling with water is most efficient;
- For new installations a site should be selected for the availability of sufficient quantities of (surface) water in the case of large cooling water demand;
- The cooling demand should be reduced by optimising heat reuse;
- For new installations a site should be selected for the availability of an adequate receiving water, particularly in case of large cooling water discharges;
- Where water availability is limited, a technology should be chosen that enables different modes of operation requiring less water for achieving the required cooling capacity at all times;
- In all cases recirculating cooling is an option, but this needs careful balancing with other factors, such as the required water conditioning and a lower overall Energy efficiency.

For existing water cooling systems, increasing heat reuse and improving operation of the system can reduce the required amount of cooling water. In the case of rivers with limited availability of surface water, a change from a once-through system to a recirculating cooling systems is a technological option and may be considered BAT.

For power stations with large cooling capacities, this is generally considered as a cost-intensive exercise requiring a new construction. Space requirements must be taken into account.

4.4.2 Identified reduction techniques within the BAT-approach

Table 4.4: BAT for reduction of water requirements

Relevance	Criterion	Primary BAT approach	Remarks	Ref.
All wet cooling systems	Reduction of need for cooling	Optimisation of heat reuse		Ch.1
	Reduction of use of limited sources	Use of groundwater is not BAT	Site-specific in particular for existing systems	Ch.2
	Reduction of water use	Apply recirculating systems	Different demand on water conditioning	Ch.2/3.3
	Reduction of water use, where obligation for plume reduction and reduced tower height	Apply hybrid cooling system	Accept energy penalty	Ch.2.6/ 3.3.1.2
	Where water (make-up water) is not available during (part of) process period or very limited (drought-stricken areas)	Apply dry cooling	Accept energy penalty	Section 3.2 and 3.3 Annex XII.6
All recirculating wet and wet/dry cooling systems	Reduction of water use	Optimization of cycles of concentration	Increased demand on conditioning of water, such as use of softened make-up water	Section 3.2 and section XI

Application of dry air-cooling has been suggested on a number of occasions. If the overall Energy efficiency is taken into account, dry air-cooling is less attractive than wet cooling. With this the dry technology is not disqualified. For shorter lifetime periods it was calculated that the differences in costs between dry and wet become less than for longer lifetime periods. When costs for water and water treatment are taken into account, differences also become smaller. Dry cooling can be recommended in certain circumstances and for precooling at higher temperature levels, where excessive water would be needed.

4.5 Reduction of entrainment of organisms

4.5.1 General

The adaptation of water intake devices to lower the entrainment of fish and other organisms is highly complex and site-specific. Changes to an existing water intake are possible but costly. From the applied or tested fish protection or repulsive technologies, no particular techniques can yet be identified as BAT. The local situation will determine which fish protection or repulsive technique will be BAT. Some general applied strategies in design and position of the intake can be considered as BAT, but these are particularly valid for new systems.

On the application of sieves it should be noted that costs of disposal of the resulting organic waste collected from the sieves can be considerable.

4.5.2 Identified reduction techniques within the BAT-approach

Table 4.5: BAT for reduction of entrainment

Relevance	Criterion	Primary BAT approach	Remarks	Ref.
All once-through systems or cooling systems with intakes of surface water	Appropriate position and design of intake and selection of protection technique	Analysis of the biotope in surface water source	Also critical areas, such as spawning grounds, migration areas and fish nurseries	Section 3.3.3 and Annex XII.3.3
	Construction of intake channels	Optimise water velocities in intake channels to limit sedimentation; watch for seasonal occurrence of macrofouling		Section 3.3.3

4.6 Reduction of emissions to water

4.6.1 General BAT approach to reduce heat emissions

Whether heat emissions into the surface water will have an environmental impact strongly depends on the local conditions. Such site conditions have been described, but do not lead to a conclusion on BAT in general terms.

Where, in practice, limits to heat discharge were applicable, the solution was to change from once-through technology to open recirculating cooling (open wet cooling tower). From the

available information, and considering all possible aspects, care must be taken in concluding that this can be qualified as BAT. It would need to balance the penalty increase in overall energy efficiency of applying a wet cooling tower (Chapter 3.2) against the effect of reduced environmental impact of reduced heat discharge. In a fully integrated assessment at the level of a river catchment, this could for example include the raised overall efficiency levels of other processes using the same, but now colder, water source, which becomes available because there is no longer a large warm water discharge into it.

Where the measures generally aim at reducing the ΔT of the discharged cooling water, a few conclusions on BAT can be drawn. Pre-cooling (Annex XII) has been applied for large power plants where the specific situation requires this, e.g. to avoid raised temperature of the intake water.

Discharges will have to be limited with reference to the constraints of the requirements of Directive 78/659/EEC for fresh water sources. The criteria are summarised in Table 3.6. Reference is made to a provision in Article 11 of this directive regarding derogation of the requirements in certain circumstances.

4.6.2 General BAT approach to reduce chemical emissions to water

Prevention and control of chemical emissions resulting from cooling systems have received the most attention in Member States' policies and industry. Next to heat discharge they are still considered to be the most important issue in cooling.

Referring to the statement that 80% of the environmental impact is decided on the design table, measures should be taken in the design phase of wet cooling system using the following order of approach:

- identify process conditions (pressure, T, corrosiveness of substance),
- identify chemical characteristics of cooling water source,
- select the appropriate material for heat exchanger combining both process conditions and cooling water characteristics,
- select the appropriate material for other parts of the cooling system,
- identify operational requirements of the cooling system,
- select feasible cooling water treatment (chemical composition) using less hazardous chemicals or chemicals that have lower potential for impact on the environment (Section 3.4.5, Annex VI and VIII)
- apply the biocide selection scheme (Chapter 3, Figure 3.2) and
- optimise dosage regime by monitoring of cooling water and systems conditions.

This approach intends to reduce the need for cooling water treatment in the first place. For existing systems technological changes or changes to the equipment are difficult and generally cost-intensive. Focus should be on the operation of the systems using monitoring linked to optimized dosage. A few examples of techniques with good performances have been identified. They are generally applicable for certain categories of systems, they are considered cost effective and do not need large changes to the cooling installation.

After reducing the sensitivity of the cooling system to fouling and corrosion, treatment may still be needed to maintain an efficient heat exchange. Selecting cooling water additives less harmful to the aquatic environment and to applying them in the most efficient way is then the next step.

With respect to the selection of chemicals, it has been concluded that a ranking of treatments and the chemicals of which they are composed is difficult if not impossible to carry out in a general way and would be unlikely to lead to BAT conclusions. Due to the large variation in conditions and treatments only a site-by-site assessment will lead to the appropriate solution.

Such an assessment and its constituent parts could represent an approach that can be considered BAT.

This approach is offered in this BREF and consists of a tool that can assist in a first ranking of selected chemicals and of an approach to assess biocides, linking the requirements of the cooling system to requirements of the receiving aquatic ecosystem (Annex VIII). The approach aims at minimising the impact of cooling water additives and, in particular, biocides. The Biocidal Products Directive 98/8/EC (BPD) and the Water Framework Directive (WFD) form the key building blocks for this approach. It is essential to use PEC and PNEC values for the different substances, where the PEC/PNEC ratio could function as a yardstick for BAT determination.

On the application of specific substances, much experience has been obtained in once-through systems with chlorine-derived components (in particular hypochlorite, chloramine) and chlorine/bromine combinations, as well as with the application of reduced concentration levels.

The same applies to the use of biocides for conditioning of recirculating systems. Treatments for these systems are often multisubstances. It is clear that some components or substances can be identified as not BAT or should not be applied at all. A general approach to select the appropriate biocide will include local aspects, such as the water quality objectives of the receiving surface water.

4.6.3 Identified reduction techniques within the BAT-approach

4.6.3.1 Prevention by design and maintenance

Table 4.6: BAT for reduction of emissions to water by design and maintenance techniques

Relevance	Criterion	Primary BAT approach	Remarks	Reference
All wet cooling systems	Apply less corrosion-sensitive material	Analysis of corrosiveness of process substance as well as of cooling water to select the right material		Ch.3.4
	Reduction of fouling and corrosion	Design cooling system to avoid stagnant zones		Annex XI.3.3.2.1
Shell&tube heat exchanger	Design to facilitate cleaning	Cooling water flow inside tube and heavy fouling medium on tube side	Depending on design, process T and pressure	Annex III.1
Condensers of power plants	Reduce corrosion-sensitiveness	Application of Ti in condensers using seawater or brackish water		Annex XII
	Reduce corrosion-sensitiveness	Application of low corrosion alloys (Stainless Steel with high pitting index or Copper Nickel)	Change to low corrosion alloys can affect formation of pathogens	Annex XII.5.1
	Mechanical cleaning	Use of automated cleaning systems with foam balls or brushes	In addition mechanical cleaning and high water pressure may be necessary	Annex XII.5.1
Condensers and heat exchangers	Reduce deposition (fouling) in condensers	Water velocity > 1.8 m/s for new equipment and 1.5 m/s in case of tube bundle retrofit	Depending on corrosion sensitivity of material, water quality and surface treatment	Annex XII.5.1
	Reduce deposition (fouling) in heat exchangers	Water velocity > 0.8 m/s	Depending on corrosion sensitivity of material, water quality and surface treatment	Annex XII.3.2
	Avoid clogging	Use debris filters to protect the heat exchangers where clogging is a risk		Annex XII

Table 4.6 (continued): BAT for reduction of emissions to water by design and maintenance techniques

Relevance	Criterion	Primary BAT approach	Remarks	Reference
Once-through cooling system	Reduce corrosion-sensitiveness	Apply carbon steel in cooling water systems if corrosion allowance can be met	Not for brackish water	Annex IV.1
	Reduce corrosion-sensitiveness	Apply reinforced glass fibre plastics, coated reinforced concrete or coated carbon steel in case of underground conduits		Annex IV.2
	Reduce corrosion-sensitiveness	Apply Ti for tubes of shell&tube heat exchanger in highly corrosive environment or high quality stainless steel with similar performance	Ti not in reducing environment, optimised biofouling control may be necessary	Annex IV.2
Open wet cooling towers	Reduce fouling in salt water condition	Apply fill that is open low fouling with high load support		Annex IV.4
	Avoid hazardous substances due to anti-fouling treatment	CCA treatment of wooden parts or TBTO containing paints is <u>not</u> BAT		Section 3.4 Annex IV.4
Natural draught wet cooling towers	Reduce anti-fouling treatment	Apply fill under consideration of local water quality (e.g. high solid content, scale)		Annex XII.8.3

4.6.3.2 Control by optimised cooling water treatment

Table 4.7: BAT for reduction of emissions to water by optimised cooling water treatment

Relevance	Criterion	Primary BAT approach	Remarks	Reference
All wet systems	Reduce additive application	Monitoring and control of cooling water chemistry		Section 3.4 and Annex XI.7.3
	Use of less hazardous chemicals	It is <u>not BAT</u> to use <ul style="list-style-type: none"> chromium compounds mercury compounds organometallic compounds (e.g. organotin compounds) mercaptobenzothiazole shock treatment with biocidal substances other than chlorine, bromine, ozone and H₂O₂ 		Section 3.4/ Annex VI
Once-through cooling system and open wet cooling towers	Target biocide dosage	To monitor macrofouling for optimising biocide dosage		Annex XI.3.3.1.1
Once-through cooling system	Limit application of biocides	With sea water temperature below 10-12°C no use of biocides	In some areas winter treatment may be needed (harbours)	Annex V
	Reduction of FO emission	Use of variation of residence times and water velocities with an associated FO or FRO-level of 0.1 mg/l at the outlet	Not applicable for condensers	Ch.3.4 Annex XI.3.3.2
	Emissions of free (residual) oxidant	FO or FRO ≤ 0.2 mg/l at the outlet for continuous chlorination of sea water	Daily (24h) average value	Annex XI.3.3.2
	Emissions of free (residual) oxidant	FO or FRO ≤ 0.2 mg/l at the outlet for intermittent and shock chlorination of sea water	Daily (24h) average value	Annex XI.3.3.2
	Emissions of free (residual) oxidant	FO or FRO ≤ 0.5 mg/l at the outlet for intermittent and shock chlorination of sea water	Hourly average value within one day used for process control requirements	Annex XI.3.3.2
	Reduce amount of OX-forming compounds in fresh water	Continuous chlorinating in fresh water is <u>not BAT</u>		

Table 4.7 continued: BAT for reduction of emissions to water by optimised cooling water treatment

Relevance	Criterion	Primary BAT approach	Remarks	Reference
Open wet cooling towers	Reduce amount of hypochlorite	Operate at $7 \leq \text{pH} \leq 9$ of the cooling water		Annex XI
	Reduce amount of biocide and reduce blowdown	Application of side-stream biofiltration is BAT		Annex XI.3.1.1
	Reduce emission of fast hydrolyzing biocides	Close blowdown temporarily after dosage		Section 3.4
	Application of ozone	Treatment levels of ≤ 0.1 mg O ₃ /l	Assessment of total cost against the application of other biocides	Annex XI.3.4.1

4.7 Reduction of emissions to air

4.7.1 General approach

Comparatively, air emissions from cooling towers have not been given much attention, except for the effects of plume formation. From some reported data it is concluded that levels are generally low but that these emissions should not be neglected.

Lowering concentration levels in the circulating cooling water will obviously affect the potential emission of substances in the plume. Some general recommendations can be made which have a BAT-character.

Avoid

4.7.2 Identified reduction techniques within the BAT-approach

Table 4.8: BAT for reduction of emissions to air

Relevance	Criterion	Primary BAT approach	Remarks	Reference
All wet cooling towers	Avoid plume reaching ground level	Plume emission at sufficient height and with a minimum discharge air velocity at the tower outlet		Chapter 3.5.3
	Avoid plume formation	Application of hybrid technique or other plume suppressing techniques such as reheating of air	Need local assessment (urban areas, traffic)	Chapter 3.5.3
All wet cooling towers	Use of less hazardous material	Use of asbestos, or wood preserved with CCA (or similar) or TBTO is <u>not</u> <u>BAT</u>		Chapter 3.8.3
	Avoid affecting indoor air quality	Design and positioning of tower outlet to avoid risk of air intake by air conditioning systems	Is expected to be less important for large natural draught CT with considerable height	Section 3.5
All wet cooling towers	Reduction of drift loss	Apply drift eliminators with a loss <0.01% of total recirculating flow	Low resistance to airflow to be maintained	Section 3.5 and XI.5.1

4.8 Reduction of noise emissions

4.8.1 General

Noise emissions have local impact. Noise emissions of cooling installations are part of the total noise emissions from the site. A number of primary and secondary measures have been identified that can be applied to reduce noise emissions where necessary. The primary measures change the sound power level of the source, where the secondary measures reduce the emitted noise level. The secondary measures in particular will lead to pressure loss, which has to be compensated by extra energy input, which reduces overall energy efficiency of the cooling system. The ultimate choice for a noise abatement technique will be an individual matter, as will the resulting associated performance level. The following measures and minimum reduction levels are considered as BAT.

4.8.2 Identified reduction techniques within the BAT-approach

Table 4.9: BAT for the reduction of noise emissions

Cooling system	Criterion	Primary BAT approach	Associated reduction levels	Ref.
Natural draught cooling towers	Reduce noise of cascading water at air inlet	Different techniques available	≥ 5 dB(A)	Section 3.6
	Reduce noise emission around tower base	E.g application of earth barrier or noise attenuating wall	< 10 dB(A)	Section 3.6
Mechanical draught cooling towers	Reduction of fan noise	Apply low noise fan with characteristics, e.g.: - larger diameter fans; - Reduced tip speed (≤ 40 m/s)	< 5 dB(A)	Section 3.6
				Section 3.6
	Optimised diffuser design	Sufficient height or installation of sound attenuators	Variable	Section 3.6
	Noise reduction	Apply attenuation measures to inlet and outlet	≥ 15 dB(A)	Section 3.6

4.9 Reduction of risk of leakage

4.9.1 General approach

To reduce the risk of leakage, attention must be paid to the design of the heat exchanger, the hazardousness of the process substances and the cooling configuration. The following general measures to reduce the occurrence of leakages can be applied:

- select material for equipment of wet cooling systems according to the applied water quality;
- operate the system according to its design,
- if cooling water treatment is needed, select the right cooling water treatment programme,
- monitor leakage in cooling water discharge in recirculating wet cooling systems by analysing the blowdown.

4.9.2 Identified reduction techniques within the BAT-approach

Table 4.10: BAT to reduce the risk of leakage

Relevance ¹⁾	Criterion	Primary BAT approach	Remarks	Reference
All heat exchangers	Avoid small cracks	ΔT over heat exchanger of $\leq 50^\circ\text{C}$	Technical solution for higher ΔT on case-by-case basis	Annex III
Shell&tube heat exchanger	Operate within design limits	Monitor process operation		Annex III.1
	Strength of tube/tube plate construction	Apply welding technology	Welding not always applicable	Annex III.3
Equipment	Reduce corrosion	T of metal on cooling water side $< 60^\circ\text{C}$	Temp. affects inhibition of corrosion	Annex IV.1
Once-through cooling systems	VCI score of 5-8	Direct system $P_{\text{cooling water}} > P_{\text{process}}$ and monitoring	Immediate measures in case of leakage	Annex VII
	VCI score of 5-8	Direct system $P_{\text{cooling water}} = P_{\text{process}}$ and automatic analytical monitoring	Immediate measures in case of leakage	Annex VII
	VCI score of ≥ 9	Direct system $P_{\text{cooling water}} > P_{\text{process}}$ and automatic analytical monitoring	Immediate measures in case of leakage	Annex VII
	VCI score of ≥ 9	Direct system with heat exchanger of highly anticorrosive material/ automatic analytical monitoring	Automatic measures in case of leakage	Annex VII
	VCI score of ≥ 9	Change technology - indirect cooling - recirculating cooling - air cooling		Annex VII
	Cooling of dangerous substances	Always monitoring of cooling water		Annex VII
	Apply preventive maintenance	Inspection by means of eddy current	Other non-destructive inspection techniques are available	
Recirculating cooling systems	Cooling of dangerous substances	Constant monitoring of blowdown		

1) Table not applicable for condensers

4.10 Reduction of biological risk

4.10.1 General approach

To reduce the biological risk due to cooling systems operation, it is important to control temperature, maintain the system on a regular basis and avoid scale and corrosion. All measures are more or less within the good maintenance practice that would apply to a recirculating wet cooling system in general. The more critical moments are start-up periods, where systems' operation is not optimal, and standstill for repair or maintenance. For new towers consideration

must be given to design and position with respect to surrounding sensitive objects, such as hospitals, schools and accommodation for elderly people.

4.10.2 Identified reduction techniques within the BAT-approach

Table 4.11: BAT to reduce biological growth

Cooling system	Criterion	Primary BAT approach	Remarks	Reference
All wet recirculating cooling systems	Reduce algae formation	Reduce light energy reaching the cooling water		Section 3.7.3
	Reduce biological growth	Avoid stagnant zones (design) and apply optimized chemical treatment		
	Cleaning after outbreak	A combination of mechanical and chemical cleaning		Section 3.7.3
	Control of pathogens	Periodic monitoring of pathogens in the cooling systems		Section 3.7.3
Open wet cooling towers	Reduce risk of infection	Operators should wear nose and mouth protection (P3-mask) when entering a wet cooling tower	If spraying equipment is on or when high-pressure cleaning	Section 3.7.3

5 CONCLUDING REMARKS

5.1 Timing of the work

The work on this BAT Reference document started in June 1997 with the kick-off meeting on 19-20 June 1997 describing the scope and the key environmental issues. Originally the scope included vacuum systems as well, but due to their highly process-related characteristics it was considered to be too complex to cover in a general way and was left out of the work.

Two drafts were issued to the Technical Working group (TWG) for consultation. The first draft was issued in June 1999 and the second in March 2000. In both consultation periods comments and new information were submitted.

The final TWG meeting was held on the 29-31 May 2000 and a high level of consensus was obtained on content as well as on the BAT conclusions was obtained. There was general support for BAT conclusions on the horizontal subject of industrial cooling systems. The reference to local aspects and its consequences for the BAT conclusion were strongly debated. The optimisation of cooling water conditioning as a major aspect of cooling systems operation was also heavily discussed. Comments and new information submitted during and after the meeting have been incorporated in the final report.

In the main part of the document, the general approach to arrive at BAT for industrial cooling systems is explained. The main conclusions on BAT are presented in Chapter 4. A large number of annexes illustrates the general concepts with practical examples.

5.2 Sources of information

As sources of information a large number of documents, reports and information from cooling system operators and authorities as well as from suppliers of equipment and cooling water chemicals has been used to draft the document.

Of these the documents tm001 (NL), tm056 and tm132 (Power Industry) and tm139 (Equipment suppliers) can be considered as general building blocks. Other information submitted was more focused on a particular environmental issue, where the emphasis was largely on cooling water conditioning.

Information was further obtained during site visits and by personal communication on selection of technology and on experiences with the application of reduction techniques.

5.3 Recommendations for future work

Cooling is an essential element in many industrial processes. The assessment of best available techniques for cooling systems has revealed that internal heat management, selection and operation of the cooling system and the resulting emissions to the environment are directly related. However, the BREF-process has not been able to identify examples that give a quantified illustration of this principle and a future BREF would benefit from further investigation.

Within the Technical Working Group there clearly is agreement that BAT for cooling systems is an approach within which a number of specific techniques can be identified. It is a complex issue involving thermodynamic principles and interaction with the characteristics of the process. It is clear that BAT for cooling systems is a balance of the demands of the industrial process to be cooled, the design and operation of the cooling system and the costs. For this purpose a

BAT-approach is developed with the emphasis on prevention by technological changes and improving operating practice. This approach makes a distinction between new and existing cooling systems, but in this document it is emphasised that reduction measures in existing cooling systems have the same objective. In other words, the same approach applies, but it is clear that options for reduction are limited in existing cooling systems.

The process of exchange of information has made it possible to identify a number of techniques that can be considered BAT on a general level, as presented in Chapter 4.

To determine techniques under the primary BAT approach for cooling systems, however, has been difficult. There seems to be reluctance to identify specific reduction techniques in the framework of a horizontal issue, where general application may not be so obvious.

On the change in technology with an associated reduction in emissions no detailed information on a practical example has been made available to illustrate the potential for improvements, acknowledging that identical changes in similar cooling configurations could still have different associated reduction levels. Comparisons of the performance of systems would need comparable units and it is suggested that performance data be expressed per unit of heat dissipated (MW_{th}). Examples can be found in the document, where this was feasible.

Concerning the environmental issues associated with the operation of the industrial cooling systems in the scope of this document, emphasis is largely on reduction of emissions to the aquatic environment. Few data were reported that are considered as representative and an inventory is recommended to be able to get a better picture, which could serve as a benchmark for results of (future) reduction techniques.

The TWG considers the selection of cooling water additives to be an important pathway to reduce potentially harmful emissions to the aquatic environment. A general assessment procedure which includes local characteristics is necessary to make a selection at a local level. Two concepts are presented in this BREF to aid the local assessment of cooling water additives. The TWG considers both concepts as valuable tools, but the benchmark concept (Annex VIII.1) is still a theoretical model and will need further examination.

Emissions to air from wet cooling towers may contain chemicals or bacteria, but it was a common view in the TWG that very few data exist. To identify their importance would need accurate measurement to quantify emissions, given certain water conditioning regimes and efficiency of the drift eliminators. Further investigation on available data will be needed.

In some Member States a lot of attention is currently paid to the development of *Legionella* in wet cooling towers as a result of some recent outbreaks of Legionnaires disease. Hence the relatively large section paying attention to this aspect. From the information submitted it is clear that further work is needed to establish representative concentration levels of *Legionella* and to improve treatments for systems cleaning after outbreaks as well as for daily maintenance.

A maximum level of acceptable colony forming units (CFU) in a cooling system with an associated low risk has not been determined. At present it is not clear if such a level can be identified and future work may identify progress in this field of work.

A number of techniques were identified and considered BAT, but some are still in a stage of development and may be considered as emerging. Their application and environmental consequences still have to be assessed. Examples of these techniques are the spray (or evaporative) ponds and cold and heat storage.

It is recommended that this document be revised in 3 years' time to assess the above-mentioned points.

REFERENCES

[Comment-1, ..]

Information submitted as comment on the first draft of the BREF-document by TWG-member (Member State or institute)

[Correia, 1995]

Correia F.N. et al, Water availability, uses and institutions in Europe, Summary report and vertical issues, Congres Center Instituto Superior Técnico (Lissabon (P), 1995).

[Hadderigh, 1978]

Hadderigh, R.H., 1978. Mortality of young fish in the cooling water system of Bergum power station. Verh. Internat. Verein. Limnol., vol. 20, pp. 1827-1832.

[Haddingh, 1983]

Haddingh, R.H. et al., 1983. Fish impingement at power stations situated along the rivers Rhine and Meuse in the Netherlands. Hydrobiological Bulletin 17 (2), pp. 129-141.

[KEMA, 1972]

KEMA, 1972. Invloed van maaswijdte van de draaizeven op passage en overleving van met het koelwater ingezogen jonge vis bij de Flevo-centrale. KEMA-memorandum VII 78-87, MO-biol.

[KEMA, 1982]

KEMA, 1982. Visproblemen bij de inlaat van centrales; samenvatting van een voordracht op de 22^e vergadering van de Kring van Chemici van Centrales. KEMA-memorandum 82-12 MO-biol.

[KEMA, 1992]

KEMA, 1992. Bemonstering van ingezogen vis bij eenheid 13 van centrale Gelderland in maart, juli en november van 1990 en 1991. KEMA-rapport 71176-MOB 92-3652.

[Carter and Reader, in press]

Carter, K.L. and J.P. Reader, (in press), Patterns of drift and power station entrainment of 0⁺ fish in the River Trent, England.

[tm001, Bloemkolk, 1997]

Bloemkolk, J.W. Industrial cooling water discharge. Cooling systems and emissions. Ministry of Transport, Public Works and Water Management, Directorate-General of Water Management, RIZA. Report number: 95.050 (Lelystad (NL), 1995, English translation 1997). ISBN 9036945445

[tm003, Van der Schaaf, 1995]

Schaaf R.J van der., Eindrapport alternatieve koelsystemen industrie. Final report by Fluor Daniel in order of Ministry of Transport, Public Works and Water Management, Directorate-General of Water Management, RIZA (Lelystad (NL), 1995).

[tm004, Baltus and Berbee, 1996]

Baltus C.A.M., Berbee R.P.M., Het gebruik van biociden in recirculatiekoelsystemen. Ministry of Transport, Public Works and Water Management, Directorate-General of Water Management, RIZA. Report number: 95.036 (Lelystad (NL), 1996). ISBN 903694550X.

[tm005, Van Donk and Jenner, 1996]

Donk M van., Jenner H.A., Optimization of biofouling control in industrial cooling water systems with respect to the environment. Edit. KEMA, by order of RIZA (Arnhem (NL), 1996).

[tm010, Betz, 1991]

Betz handbook of industrial water conditioning, 9th edition, Trevese, U.S.A (1991).

[tm012, UBA, 1982]

Umweltbundesamt, Abwärmekommission (edit.) Abwärme - Auswirkungen, Verminderung, Nutzung, Bericht 82-3, Berlin (D) 1982.

[tm014, KEMI, 1991]

Kemikalieinspektionen 6/91 (Solna, (S), 1991). Miljöfarligheten hos mikrobiocider i kylvatten. (ISSN: 0284-1185).

[tm032, Zimmerman and Hamers, 1996]

Zimmerman, P. and J.P. Hamers, Planung und Bau eines Schwadenfreien geräuscharmen Hybridkühlturmes mit einer umweltschonenden Wasserbehandlung durch Ozon für ein GuD-Kraftwerk in den Niederlanden, VGB Kraftwerkstechnik 76, 1996, Heft 6 (p.502-505).

[tm034, Hobson et al., 1995]

Hobson, E., P. Lindahl and T. Massey, Leistungssteigerung mit Kühlturmeinbauten aus NPF (National Power Fill), VGB Kraftwerkstechnik 75, Heft 9 (p. 829-833)

[tm036, Wilsey, 1997]

Wilsey, C.A., Alternative water treatment for cooling towers. ASHRAE Journal April, 1997 (p.43-46).

[038, Millar et al., 1997]

Millar, J.D., G.K. Morris and B.G. Shelton, Legionnaires' disease: seeking effective prevention, ASHRAE Journal, 1997 (p.22-29)

[tm039, Strittmatter et.al., 1996]

Strittmatter, R.J., Yang B., Johnson D.A., Ozone application for cooling tower water. ASHRAE Journal, 1996.

[tm040, Schulze-Robbecke and Richter, 1994]

Schulze-Röbbecke, R. and Richter, M., Entstehung und Vermeidung von Legionelleninfektionen durch Kühltürme und Rückkühlwerke, GI Gesundheits -Ingenieur Haustechnik-Bauphysik-Umwelttechnik 115, 1994 (p.71-77).

[tm041, Burger, 1994]

Burger, R., Select the right cooling tower fill, Hydrocarbon Processing, August 1994 (p. 141-143).

[tm042, Veil and Moses, 1995]

Veil, J.A., Moses, D.O., Consequences of proposed changes to clean water act thermal discharge requirements. Paper presented to EPRI, international Clean Water Conference, (Jolla, CA (USA), 1995).

[tm044, Carhart and Policastro, 1991]

Carhart, R.A. and Policastro, A.J., A second-generation model for cooling tower plume rise and dispersion – I. Single sources. Atmospheric Environment Vol.25A, no. 8, 1991 (pp. 1559-1576).

[tm046, Vanderheyden and Schuyler, 1994]

Vanderheyden, M.D., Schuyler, G.D., Evaluation and quantification of the impact of cooling tower emissions on indoor air quality, ASHRAE Transactions of Annual Meeting, Vol. 100, part 2 (p. 612-620)

- [tm056, Caudron, 1991]
Caudron, L., Les réfrigérants atmosphériques industriels, éditions Eyrolles, Paris (1991).
- [tm059, Mortier, 1995]
Mortier, R., Pretreatment and desalting of contaminated and brackish surface water with reverse osmosis, Proceedings of Watersymposion 1995 (p.144-158), Breda (NL).
- [tm059, Paping, 1995]
Paping, L.L.M.J., Energiebesparing door schone koelers, Proceedings of Watersymposion 1995 (p.23-47), Breda (NL).
- [tm061, Eurovent/Cecomaf, 1997]
Eurovent/ (WG 9, Cooling towers), Mechanical draught cooling tower acoustics, practical guide, Paris, Draft December 1997.
- [tm062, Dallmier, 1997]
Dallier, A.W., J.D. Martens and W.F. McCoy, performance of stabilized halogen biocides in cooling water, report 398, Naperville, Illinois (USA), 1997).
- [tm064, Meier, 1990]
Meier, D.A., Zero blowdown - A solution for water conservation, International Water Conference, October 1990, Reprint nr. 529.
- [tm065, Meier and Fulks, 1990]
Meier, D.A., and K.E. Fulks, Water treatment options and considerations for water reuse, National Association of Corrosion Engineers Corrosion '90 meeting, Las Vegas (USA), Reprint nr. 520.
- [tm066, Phillips and Strittmatter, 1994]
Phillips, E.C., and R.J. Strittmatter, Reuse of industrial waste stream as cooling tower makeup, 1994 Cooling Tower Institute Annual Meeting, Houston Texas (USA), 1994).
- [tm067, Hoots et al, 1993]
Hoots, J.E., B.V. Jenkins and E.C. Ray, Choosing chemical dosage control for cooling water inhibitors and dispersants, Paper presented at Meeting of International District Heating and Cooling Association October 27-29, 1993, Tulsa (USA), Reprint 622, Nalco.
- [tm068, Ambrogi, 1997]
Ambrogi, R., Environmental impact of biocidal antifouling alternative treatments of sea water once-through cooling systems (1997). Proceedings of symposium on chlorine dioxide and disinfection, Rome (I), 1996.
- [tm070, Benschop, 1997]
Benschop, P., The evaluation of substances and preparations in the context of the pollution of surface waters act. Ministry of Transport, Public Works and Water Management, Directorate-General of Water Management, RIZA. Report number: 98.005 (Lelystad (NL), 1997). ISBN 9036951569.
- [tm071, Niebeek, 1997]
Niebeek, G. Procedure for the evaluation of substances and preparations in the context of the pollution of surface waters act. Ministry of Transport, Public Works and Water Management, Directorate-General of Water Management, RIZA. Report number: 98.006 (Lelystad (NL), 1997). ISBN 9036951577.

[tm072, Berbee, 1997]

Berbee R.P.M., Hoe omgaan met actief chloor in koelwater? (How to use active chlorine in cooling water?), Ministry of Transport, Public Works and Water Management, Directorate-General of Water Management, RIZA. Report number: 97.077 (Lelystad (NL), 1997). ISBN 9036951240.

[tm079, CES, 1994]

Consultants in Environmental Sciences Ltd. Biocides in cooling water systems (Beckenham(UK), 1994) by order of the U.K Department of the Environment.

[tm082, Mittendorf, 1990]

Mittendorf, E.D., Removal of asbestos paper fill from large industrial cooling towers, Paper presented at 1990 Cooling Tower Institute Annual Meeting, (Houston, Texas (USA), 1990).

[tm083, Adams and Stevens]

Adams, S. and Stevens, J., Strategies for improved cooling tower economy. Paper presented at 1991 Cooling Tower Institute Annual Meeting, (New Orleans, Louisiana (USA), 1991).

[tm084, Rice and Wilkes, 1992]

Rice R.G. and Wilkes J.F.. Biocidal aspects of ozone for cooling water treatment-probable impacts of bromide ion. Paper presented at 1992 Cooling Tower Institute Annual Meeting, (Houston, Texas (USA), 1992).

[tm086, Van der Spek, 1993]

Spek, H. van der, Reduction of noise generation by cooling fans, Paper presented at 1993 Cooling Tower Institute Annual Meeting, (New Orleans, Louisiana (USA), 1993).

[tm087, Engstrom and Tully, 1994]

Engstrom, G.G. and J.C. Tully, Monitoring biological control in cooling systems, paper presented at the 1994 Cooling Tower Institute Annual Meeting, (Houston, Texas (USA), 1994).

[tm090, Grab et al, 1994]

Grab, L.A., J.A. Diemer, M.G. Freid, The effect of process leak contaminants on biocidal efficacy, Paper presented at 1994 Cooling Tower Institute Annual Meeting, (Houston, Texas (USA), 1994)

[tm091, Little et.al, 1994]

Little D. A., Mitchell WA., E.S. Lawson, The control of ferrous metal corrosion in cooling water by a novel phosphonate corrosion inhibitor. Paper presented at 1994 Cooling Tower Institute Annual Meeting, (Houston, Texas (USA), 1994).

[tm092, Becker and Burdick, 1994]

Becker, B.R. and L.F. Burdick, Drift eliminators and fan system performance, Paper presented at 1994 Cooling Tower Institute Annual Meeting, (Houston, Texas (USA), 1994).

[tm093, Mirsky, 1995]

Mirsky, G.R., Cooling tower noise, Paper presented at the 1995 Cooling Tower Institute Annual Meeting, Fort Worth (Texas (USA), 1995).

[tm094, Alfano and Sherren, 1995]

Alfano, N.J. and D.J. Sherren, Water conservation via new cooling water technology, Paper presented at the 1995 Cooling Tower Institute Annual Meeting, Fort Worth (Texas (USA), 1995).

[tm095, Cunningham, 1995]

Cunningham, R.J., Maximizing cooling tower cycles of concentration, Paper presented at the Cooling Tower Institute Annual Meeting, Fort Worth (Texas (USA), 1995).

[tm096, McCoy et al, 1995]

McCoy, W.F., S.A. Borchardt, and M.R. Hermiller, Traced biocides: a new technology for industrial water treatment, Paper presented at the 1995 Cooling Tower Institute Annual Meeting, Fort Worth (Texas (USA), 1995).

[tm97, Immell, 1996]

Immell, W.F., Variable speed fan drives for cooling towers, Paper presented at 1996 Cooling Tower Institute Annual Meeting, (Houston, Texas (USA), 1996).

[tm101, BDAG, 1996]

Balcke Dürr AG, Hybrid cooling towers, Ratingen (D), 1996.

[tm102, BDAG, 1996]

Balcke Dürr AG, Natural draught wet cooling towers-nature's good deed, Ratingen (D), 1996.

[tm103, BDAG, 1996]

Balcke Dürr AG, Mechanical draught wet cooling towers-cooling air supplied by fan power, Ratingen (D), 1996.

[tm104, Tesche, 1997]

Tesche, W., Selection criteria for different types of cooling towers, Balcke-Dürr Ratingen (D), 1997.

[tm109, BDAG, 1996]

Balcke Dürr AG, Air-cooled heat exchangers for the hydrocarbon process industry, Ratingen (D), 1996.

[tm110, BDAG, 1995]

Balcke Dürr AG, Technical information on cooling towers for salt water applications (pers. comm.)

[tm111, BDAG, 1996]

Balcke Dürr AG, Air-cooled heat exchangers, Ratingen (D), 1996.

[tm113, Streng, 1996]

Streng, A., Combined wet/dry cooling towers of a cell-type construction, American Power Conference 58th Annual Meeting, (Chicago (USA), 1996).

[tm117, Remberg and Fehndrich, 1993]

Remberg, H.-W. and B. Fehndrich, Wirkungsgradverbesserung bei naturzug-Nasskühltürmen durch Austausch von Asbestzement-Kühleinbauten gegen Kunststoff-Kühleinbauten, Kraftwerk und Umwelt, 1993 (p. 112-117).

[tm123, Alt and Mäule, 1987]

Alt, W. and R. Mäule, Hybridkühltürme im wirtschaftlichen Vergleich zu Nass- und Trockenkühltürmen, VGB Kraftwerkstechnik 8, (page 763-768), 1987.

[tm131, Dziobek, 1998]

Dziobek, Th., Ozon stopft Loch in der Kasse (Ozone fills financial gap in the pocket), Umwelttechnik (Sonderteil Wasser), April 1998.

- [tm132, Eurelectric, 1998]
BAT for Cooling Systems. Eurelectric, The European Grouping of the Electricity Supply Industry, (Brussels (B), 1997, updated 1998).
- [tm135, Nalco, 1988]
The Nalco Water Handbook, 2nd edition, USA (1988).
- [tm136, Jäggi/Günthner, 1997]
Jäggi/Günthner, Industrial coolers, Technical information, edit. 9.97, Bern (1997).
- [tm139, Eurovent, 1998]
Proposal for a BREF-document for cooling systems. Drafted by Coopers & Lybrand Umwelt (1998) by order of Eurovent, the European Committee of Air handling and Refrigeration Equipment manufacturers. Report number: 61350027.
- [tm 144, Cabanes et al, 1997]
Cabanes, P.A., E. Pringuez, F. Siclet, M. Khalanski, and P. Pernin, Continuous chlorination to control pathogenic free living amoebae in a closed loop power plant, The Environmental Professional, Volume 19, 1997 (p.192-200)
- [tm145, Werner and Pietsch, 1991]
Werner, H.-P. von, M. Pietsch, Bewertung des Infektionsrisikos durch Legionellen in Kühlkreisläufen von Kraftwerken, VGB Kraftwerkstechnik 71, Heft 8, p. 785-787 (1991)
- [tm146, Daamen and Savelkoul, 1999]
Daamen E.J., and J.T.G. Savelkoul, Zijstroom-biofiltratie in open recirculerende koelwatersystemen, In: proceedings Watersymposium '99, Breda, NL (1999).
- [tm147, Bloemkolk and Van der Schaaf, 1996]
Bloemkolk J.W., R.J. van der Schaaf, Design alternatives for the use of cooling water in the process industry: minimization of the environmental impact from cooling systems, J. Cleaner Production Vol.4, No. 1, pp. 21-27, 1996.
- [tm148, RIZA, 1996]
RIZA, Visintrek door grootschalige koelwaterinname, Problematiek en aanbevelingen, FWVO-nota 96.01 (January, 1996).
- [tm149, Baltus et al., 1999]
Baltus, C.A.M., L.C.M., Kerkum and P.G.M. Kienhuis, Acute toxiciteit van koelwaterlozingen uit recirculatiekoelsystemen, Ministry of Transport, Public Works and Water Management, Directorate-General of Water Management, RIZA. Report number: 99.025 (Lelystad (NL), 1997). ISBN 9036952492.
- [tm150, Paping, 1999]
Paping, L.L., Feasibility study on application of spray ponds, Pers. comm. on study, Dow Europe (Terneuzen (NL), 1999).
- [tm151, BAC, 1999]
Baltimore Aircoil, H₂O conserving HXI hybrid fluid cooler, Information Leaflet, Heist-op-den-Berg (B), 1999.
- [tm152, Taft, 1999]
Taft, E.P., Fish protection technologies: a status report. Alden Research Laboratory Inc., Holden (USA), 1999.

[tm153, Paping et al, 1999]

Paping, L.L.M.J., H.A. Jenner, H.J.G. Polman, B.H. te Winkel and M.R. de Potter, Ecological conditioning and optimisation of a once-through cooling water system, Proceedings of Watersymposium 1999, p.327 – 355 (Breda (NL), 1999).

[tm154, Besselink et al, 1999]

Besselink, V.V., M.A.M. Beerlage, W. de Jongh and G. Koopmans, Haalbaarheidstudie naar alternatieve koeling door middel van sproeivijvers, KEMA-report nr 99532763.EP.163 99P01, Arnhem (NL) 1999.

[tm155, Berbee, 1999]

Berbee, R.P.M., Legionella in oppervlaktewater, in koelwater, in RWZI's, in.....; waar eigenlijk niet?, Ministry of Transport, Public Works and Water Management, Directorate-General of Water Management, RIZA. Report number: 99.057 (Lelystad (NL), 1999), ISBN 9036952867.

[tm156, Schmittecker et al, 1999]

Schmittecker, B.M., K.-P. Henke, and W. Bergmann, Kühlwasserbehandlung mit Ozon. (Cooling water treatment with ozone), VGB KraftwerksTechniek 4/99.

[tm157, Jenner et al, 1998]

Jenner, H.A., J.W. Whitehouse, C.J.L. Taylor and M. Khalansky, Cooling water management in cooling power stations-Biology and control of fouling, Hydroecologie Appliquee, Tome 10, Volume 1-2, 1998, ISSN: 1147-9213.

[tm158, VGB, 1998]

VGB, VGB-Richtlinie, Lärminderung in Wärmekraftanlagen, VGB-R 304, April 1998.

[tm159, KEMA/EPON, 1993]

KEMA by order of N.V. EPON, Milieu-effect rapport WKC-Nijmegen (Environmental effect report Heat and Power Unit Nijmegen), Arnhem (NL), 1993, Ref.nr. KEMA 21446-KEC 92-363.

[tm160, Bijstra, 1999]

Bijstra, D., Verantwoord omgaan met biociden in koelwater. FWVO-rapport 99.02. (NL, 1999)

[tm161, Borgerding, 1998]

Borgerding, P.H., Koelsystemen. "Koeling is meer dan warmte alleen". (Cooling systems. "Cooling is more than just heat"). Ministry of Transport, Public Works and Water Management, Directorate-General of Water Management, RIZA. Report number: 98.056 (Lelystad (NL), 1998), ISBN 9036952107.

[tm164, Travade, 1987]

Travade F., Aspiration d'organismes aux prises d'eau des centrales (RGN, 1, pp 59-62, 1987).

[tm165, Turnpenny et al, 1985]

Turnpenny, A.H.W., T.E. Langford and R.J.Aston, Power Stations and Fish. (ECB Research, pp 27-39, 1985).

[tm166, Morton et al, 1986]

Morton, S.J., C.L.R. Bartlett, L.F. Bibby, D.N. Hutchinson, J.V. Dyer, P.J. Dennis, Outbreak of legionnaires' disease from a cooling water system in a power station. British Journal of Industrial Medicine 1986; 43: 630-635.

[tm167, Fliermans, 1996]

Fliermans, C.B., Ecology of *Legionella*: From data to knowledge with a little wisdom. Microbial Ecology 1996; 32: 203 – 228.

References

[tm168, De Potter et al, 1996]

De Potter, M.R., H.J.G. Polman and B.H. te Winkel, Effectiveness and environmental impact of elevated hypochlorite dosing at Dow Benelux 1995, KEMA-report 64683-KES/WBR 96-3114

[tm169, De Potter et al, 1997]

De Potter, M.R., H.J.G. Polman and B.H. te Winkel, Effectiveness and environmental impact of elevated hypochlorite dosing at Dow Benelux 1996, KEMA-report 64683-KES/WBR 97-3128

[tm170, De Potter and Polman, 1999]

De Potter, M.R. and H.J.G. Polman, Effectiveness and environmental impact of elevated hypochlorite dosing at Dow Benelux 1997, KEMA-report 9756058-KPG/CET 99-4403

[tm171, Polman, 2000]

Polman H.J.G., Antifouling optimisation by pulse-alternating chlorination at Dow Benelux 1999, KEMA-report 99550566-KPS/MEC.

ANNEXES

Table of contents

ANNEX I	THERMODYNAMIC PRINCIPLES.....	155
I.1	Heat transfer in a shell and tube heat exchanger	155
I.2	Approach.....	156
I.3	Capacity of a heat exchanger.....	157
I.4	Wet and dry bulb temperatures	158
I.5	Relation between heat transfer and heat exchanging surface	158
ANNEX II	PRINCIPLE OF ENERGY SAVING THROUGH OPTIMISED COOLING	161
II.1	Subject.....	161
II.2	Summary of conclusions	161
II.3	Introduction.....	162
II.4	Calculations.....	164
II.4.1	Principles	164
II.4.2	Quantity of cooling water \uparrow	166
II.4.3	Quantity of cooling air \uparrow	167
II.4.4	Product temperature \uparrow ; gas volume \uparrow	168
II.4.5	Product pressure \uparrow ; cooling compressor \uparrow	169
II.5	Total potential energy conservation per °C colder cooling-water boundary layer	170
II.5.1	Efficiency of power generation \uparrow	170
II.5.2	Total water used for cooling in the Dutch industry (excl. power plants)	171
II.5.3	Total potential energy conservation per °C colder cooling-water boundary layer	172
II.6	Examples of calculations for the relative conservation of energy and reduction of the environmental impact achieved by the use of inhibitors	173
II.6.1	The contribution made by oxidation	173
II.6.1.1	Once-through cooling system	173
II.6.1.2	Open recirculating system	174
II.7	Examples of calculations of the relative savings in energy with colder cooling water	176
II.7.1	Coastal water versus cooling towers	176
II.7.2	River water versus cooling towers	176
II.7.3	Groundwater versus cooling tower	177
II.8	Appendix environmental impacts.....	177
ANNEX III	SHELL AND TUBE HEAT EXCHANGERS FOR INDUSTRIAL ONCE-THROUGH COOLING SYSTEMS AND THE OCCURRENCE OF LEAKAGE.....	179
III.1	Design of the shell & tube heat exchanger for one through systems.....	180
III.2	Leakage in shell & tube heat exchangers	182
III.3	Alternatives	183
ANNEX IV	EXAMPLE OF SELECTION OF MATERIAL FOR COOLING WATER SYSTEMS IN INDUSTRIAL (NON-POWER PLANT) APPLICATIONS	185
IV.1	Introduction.....	185
IV.2	Direct once-through systems (with brackish water).....	186
IV.3	Indirect once-through system (brackish water/demin-water).....	188
IV.4	Open recirculating cooling systems	189
IV.4.1	Fresh water application in open wet cooling tower.....	189
IV.4.2	Salt water application in open wet cooling towers.....	189
ANNEX V	OVERVIEW OF CHEMICALS FOR THE CONDITIONING OF COOLING WATER SYSTEMS.....	191
V.1	Corrosion inhibitors	191
V.1.1	Corrosion	191
V.1.2	Applied corrosion inhibitors	191
V.2	Scale inhibitors.....	192
V.2.1	Scaling	192
V.2.2	Applied scale inhibition	192

V.3	Fouling inhibitors (dispersants)	193
V.3.1	Fouling	193
V.3.2	Applied fouling inhibitors	194
V.4	Biocides	194
V.4.1	Biofouling.....	194
V.4.2	Applied biocidal treatment	197
V.4.3	Oxidising biocides.....	197
V.4.4	Non-oxidising biocides.....	199
V.4.5	Factors determining the use of biocides.	200
V.4.6	Interactions with other water treatment chemicals	202
V.5	Cycles of concentration and water balance.....	202
ANNEX VI EXAMPLE OF LEGISLATION IN EUROPEAN MEMBER STATES .		205
ANNEX VII EXAMPLE OF A SAFETY CONCEPT FOR OPEN WET COOLING SYSTEMS (VCI-CONCEPT).....		209
VII.1	Introduction to the concept	209
VII.2	Requirements of the concept.....	211
VII.3	Appendix 1 - Automatic analytical monitoring of once-through cooling systems	213
VII.4	Appendix 2 – R-phrases used to calculate VCI-score.....	214
ANNEX VIII EXAMPLES FOR THE ASSESSMENT OF COOLING WATER CHEMICALS		217
VIII.1	Benchmark assessment concept for cooling water chemicals.....	217
VIII.1.1	Introduction	217
VIII.1.1.1	Background	217
VIII.1.1.2	Relevant legislative background	218
VIII.1.1.3	The water framework directive (WFD).....	218
VIII.1.2	Benchmarking : introduction of the concept.....	219
VIII.1.2.1	The PNEC	220
VIII.1.2.2	The PEC	221
VIII.1.3	Basic cooling towers material balances	222
VIII.1.3.1	Cooling towers basic equations.....	222
VIII.1.3.2	Water balance.....	222
VIII.1.3.3	Material balance	222
VIII.1.3.4	Concentration	223
VIII.1.3.5	Discussion	223
VIII.1.4	Calculation of PEC and benchmarking.....	224
VIII.1.5	Computation methods.....	226
VIII.1.5.1	Single Substances.....	226
VIII.1.5.2	Complex multi-substances treatments.....	226
VIII.1.6	Appendix I: extract from technical guidance document	228
VIII.2	Concept of a local assessment method for cooling water treatment chemicals, with a particular emphasis on biocides	231
VIII.2.1	Introduction	231
VIII.2.2	Key elements	232
VIII.2.3	Example of proposed local assessment method.....	235
ANNEX IX EXAMPLE OF A MODEL FOR ESTIMATING EMISSIONS OF BIOCIDES IN THE BLOWDOWN		239
ANNEX X INVESTMENT COSTS AND OPERATIONAL COSTS OF EQUIPMENT AND ELEMENTS OF COOLING SYSTEMS FOR NON-POWER PLANT APPLICATIONS.....		241
ANNEX XI EXAMPLES OF TECHNIQUES TO BE CONSIDERED WITHIN THE PRIMARY BAT APPROACH FOR INDUSTRIAL COOLING SYSTEMS		247
XI.1	Introduction	247
XI.2	Cooling water savings through water reuse	247
XI.2.1	Reuse of (waste) water for cooling tower make-up.....	248

XI.2.2	Zero discharge system.....	249
XI.2.3	Spray ponds.....	250
XI.2.4	Cold storage	251
XI.3	Reduction of emissions through optimized cooling water treatment	253
XI.3.1	Side-stream-biofiltration in an open recirculating cooling water system.....	253
XI.3.2	Physical methods	256
XI.3.3	Optimization of biocide use	258
XI.3.3.1	Monitoring.....	258
XI.3.3.1.1	Monitoring of macrofouling.....	258
XI.3.3.1.2	Traced biocides for biocide and microbiological activity	258
XI.3.3.2	Biocide dosage.....	259
XI.3.3.2.1	Different conditioning regimes to obtain optimum annual total oxidant use in once-through systems against macro- and microfouling.....	259
XI.3.3.2.2	Pulse alternating chlorination in once-through systems	261
XI.3.4	Alternative cooling water treatments	264
XI.3.4.1	Ozone.....	264
XI.3.4.2	UV treatment	266
XI.3.4.3	Catalytic hydrogen peroxide treatment.....	266
XI.3.4.4	Chlorine dioxide	267
XI.3.4.5	Ionic water purification to treat cooling tower water.....	270
XI.3.4.6	Stabilizing halogenated biocides in cooling tower water.....	270
XI.3.4.7	Filming agent against fouling, corrosion and scaling	271
XI.3.4.8	Stable organic corrosion inhibitors in open wet cooling towers	274
XI.3.5	Treatment of discharged cooling water.....	275
XI.4	Variable frequency drives for reduction of energy use	276
ANNEX XII SPECIAL APPLICATION: POWER INDUSTRY		277
	Synthesis.....	277
XII.1	Introduction.....	277
XII.2	Power plant cooling systems - principles and reminders.....	278
XII.3	Possible environmental impacts of cooling systems	279
XII.3.1	Heat discharges to the atmosphere	279
XII.3.2	Heating of receiving aquatic-environments.....	281
XII.3.3	Suction of organisms into water intakes.....	282
XII.3.4	Alteration of the receiving environment by chemical discharges	283
XII.3.5	Other possible harmful effects resulting from the choice of some cooling systems	286
XII.4	Prior study of the sites: indispensable tool for the evaluation of their receiving capacity, impact control and prevention of harmful effects	287
XII.4.1	Analysis of the situation.....	287
XII.4.2	Mathematical modellings, simulations on models and tests on pilot loops, first indispensable tools.....	287
XII.5	Design of components and choice of materials.....	288
XII.5.1	Wet cooling.....	288
XII.5.2	Hybrid cooling	289
XII.5.3	Dry cooling	290
XII.5.3.1	Forced draught air-cooled condenser.....	290
XII.5.3.2	Natural draught air-cooled condenser.....	290
XII.5.3.3	Closed recirculating dry cooling towers	291
XII.5.4	Cooling towers with discharge of cleaned flue gas	291
XII.6	Cost comparison between the various types of cooling towers.....	292
XII.7	Choice of the treatment of circulating water alternative methods - monitoring	295
XII.7.1	Anti-scale treatment	295
XII.7.2	Anti-fouling treatments (biocides)	296
XII.7.3	Monitoring	296
XII.8	Design of the cooling system	297
XII.8.1	Design and energy recovery.....	297
XII.8.2	Design and noise reduction measures	297
XII.8.3	Implementation of physical methods	297
XII.8.4	Modelling and pilot tests.....	298
XII.8.5	Choice of the cooling system	298
XII.9	Conclusions.....	298
XII.10	Literature.....	300
XII.11	Illustrations.....	306

List of tables

Table I.1: Fouling factors for shell and tube heat exchangers, indicative values [Van der Schaaf, 1995]	155
Table I.2: Specific heat capacities of air and water	157
Table I.3: Heat transfer coefficients and estimated surface areas A (m^2) per MW and at 20K mean temperature difference for different industrial applications.....	158
Table I.4: Effects of the cooling principle on the capacity, approach and cooling surface of a cooling system	159
Table II.1: Energy consumption in kW_e , electricity consumption / $MW_{th, cooling}$ with clean heat exchangers.....	163
Table II.2: Mean attainable lowest cooling water inlet temperatures for the various cooling systems during the months of July and August in the Netherlands.....	163
Table II.3: Conservation ratios for once-through and recirculating cooling system.....	177
Table II.4: Energy conservation with potential colder cooling water source.....	177
Table IV.1: Cooling water velocity and type of material	185
Table IV.2: Materials used for pumps in brackish water.....	186
Table IV.3: Materials used for shell&tube heat exchangers in brackish water.....	187
Table V.1: Survey of fouling and clogging organisms, and degree of fouling in marine, brackish and fresh water. In the last column mitigation is presented.....	195
Table V.2: Estimated consumption levels of some commonly used oxidising biocides in a few European Member States	198
Table V.3: Estimated consumption levels in some of European Member States of some commonly used non-oxidising biocides in kg/yr.....	200
Table VII.1: Score for a number of R-phrases to calculate the total score for process substances.....	210
Table VII.2: Requirements of VCI safety concept for cooling technology	211
Table VII.3: Description of R-phrases used to calculate VCI-score for cooling systems selection.....	214
Table VIII.1: Calculation of PEC and Benchmarking	225
Table VIII.2: Assessment factors to derive a PNEC.....	229
Table VIII.3: Predicted concentrations of DBNPA in different surface waters for this example.....	237
Table VIII.4: Ecological data of DBNPA.....	237
Table VIII.5: Consequences of closing the discharge.....	238
Table X.1: Cost elements for water and air cooling systems.....	243
Table X.2: Cost indications for water and air cooling systems for industrial applications with the exception of power plants (1993-1995)	244
Table XI.1: Investment and energy costs per MW_{th} for spray pond and cooling tower	251
Table XI.2: Physical techniques to minimize biocide use	257
Table XI.3: Effect of applying an optimized dosage regime on the number of leakage caused by mussels	262
Table XI.4: Typical dosage of chlorine dioxide for once-through and recirculating systems in Europe..	268
Table XI.5: Effect of chlorine dioxide applied in once-through system on larvae settlement.....	269
Table XII.1: Example of simplified balance of a thermal cycle for conventional new design	278
Table XII.2: Relationship between the installed capacity and cooling parameters.....	278
Table XII.3: Comparison of different types of recirculating cooling systems with a lifetime of 25 years and an actualisation ratio of 8% (study on EDF units of 1300 MWe)	293
Table XII.4: Comparison of wet cooling towers and aircooled condenser with a life-time of 20 years and an actualisation ratio of 8% for a combined cycle unit 290 MW_{th}	293
Table XII.5: Relationship between the concentration factor, the withdrawn water flowrate and the energy discharged into the receiving waterway (individual example).....	295

List of figures

Figure II.1: Illustration of areas of potential energy saving by reduction of the temperature gradient through a fouling layer as well as by using colder cooling water influent	162
Figure II.2: Graphic representation of pollution factors responsible for extra temperature gradient over the pipe wall	164
Figure II.3: Schematic representation of driving force over the length of a heat exchanger.....	166
Figure II.4: Number of cooling water pumps and change of cooling water low due to fouling.....	167
Figure II.5: Change of temperature gradient of product gas (moles) in a counter flow heat exchanger due to fouling	168
Figure II.6: Representation of increase of process pressure to compensate temperature increase due to fouling	169
Figure II.7: Efficiency power generation for pumps, fans and compressors.....	170
Figure III.1: Major components of shell & tube heat exchanger.....	179
Figure III.2: Heat exchanger nomenclature (Standards of the tubular Exchanger Manufacturers Association).....	181
Figure V.1: Tower and solids balances for an evaporative cooling system using a cooling tower	203
Figure V.2: Reduction of the make-up flow by concentration in an evaporative cooling system.....	203
Figure VIII.1: Cooling tower material balance	222
Figure VIII.2: Combined approach for the assessment of cooling water biocides for existing installations	234
Figure VIII.3: Schematic representation of a recirculating cooling system with the data for the example of a local selection method of cooling systems chemicals.....	236
Figure XI.1: Optimised hypochlorite dosage (pulse-alternating chlorination) taking account of fouling and cooling system characteristics	263
Figure XII.1: Once-through system.....	306
Figure XII.2: Wet cooling tower	306
Figure XII.3: Once - through cooling with cooling tower.....	307
Figure XII.4: Recirculating cooling	307
Figure XII.5: Mechanical draught cooling tower (pressure fans).....	308
Figure XII.6: Mechanical draught cooling tower (suction fans, cell construction).....	308
Figure XII.7: Mechanical draught cooling tower (pressure fans, cell construction)	309
Figure XII.8: Hybrid cooling tower	309
Figure XII.9: Forced draught air-cooled condenser	310
Figure XII.10: Natural draught air-cooled condenser	310
Figure XII.11: Closed recirculating indirect dry cooling tower	311
Figure XII.12: Cooling tower with discharge of cleaned flue gas.....	311
Figure XII.13: Cooling system with fixed concentration factor.....	312
Figure XII.14: Cooling system with sliding concentration factor	312
Figure XII.15: Decision-making logic diagram for the choice of the cooling system	313

ANNEX I THERMODYNAMIC PRINCIPLES

Potentially every change in an industrial cooling system can affect the process of heat exchange. When applying BAT to industrial cooling systems the consequences for the cooling process have to be assessed also using the thermodynamic principles.

I.1 Heat transfer in a shell and tube heat exchanger

In a counter flow design heat exchanger heat is transferred from a warm source to a cold source and the heat exchange can be described as follows:

$$Q = \Delta T_m (\ln) * U * A$$

Q	heat transferred per unit of time (W)
$\Delta T_m (\ln)$	logarithmic mean temperature difference LMTD (K)
U	overall heat transfer coefficient (W/m ² K)
A	heat exchanging surface (m ²)

The LMTD for a tube heat exchanger for counter current flow can be determined with the following equation:

$$\Delta T_m = \frac{(T_1 - t_2) - (T_2 - t_1)}{\ln\{(T_1 - t_2)/(T_2 - t_1)\}}$$

T ₁	temperature inlet warm process side (K)
T ₂	temperature outlet warm process side (K)
t ₁	temperature inlet cold side (K)
t ₂	temperature outlet cold side (K)

Heat transfer is promoted by a large surface area (A). For practical reasons there is a limit to the size of the surface area and in that case finned tubes are applied. Different sources of resistance (R) form another limitation to heat transfer. Generally, resistance R is expressed as its reciprocal value of the heat transfer coefficient 1/U and largely consists of the thickness of the wall between the two media and its conductivity and the state of fouling of the exchanging surface., but also the conductivity of the liquids is important accounting for the effect of different velocities on heat transfer.

Depending on the nature of the medium that flows through the heat exchanger, the heat-exchanging surface gets fouled. During use of the exchanger the resistance to the transfer of heat increases. For design purposes use is made of a pollution coefficient or fouling factor, that equals the maximum fouling depending on the nature of the medium or the coolant. In Table I.1 a few examples are given, where a lower fouling factor means a lower state of fouling of the heat-exchanging surface.

Table I.1: Fouling factors for shell and tube heat exchangers, indicative values [Van der Schaaf, 1995]

Medium	Fouling factors (W/m ² /K)
River water	3000-12000
Sea water	1000- 3000
Cooling water (cooling tower)	3000- 6000
Light hydrocarbons	5000
Heavy hydrocarbons	2000

Two thermodynamic principles are responsible for heat transfer:
transfer through conduction (and convection),
transfer through evaporation of a medium.

Heat transfer in a dry cooling system through conduction and convection is called *sensible heat transfer*. In a wet cooling system water is cooled down by direct contact with air. Sensible heat transfer to air in a dry cooling system can be described as follows:

$$Q = C_p * m_a * \Delta T$$

Q	heat transferred
C_p	specific heat capacity of air
ΔT	temperature range
m_a	mass of air

In a wet cooling system there is additionally heat transfer through evaporation, *latent heat transfer* and can be described with the following formula:

$$Q = m_a' * \Delta H$$

Q	heat transferred
m_a'	mass of air
ΔH	enthalpy range

With these equations the mass of air necessary for dry (m_a) and for wet (m_a') cooling can be compared:

$$\frac{m_a'}{m_a} = \frac{C_p * \Delta T}{\Delta H}$$

The ratio depends on the temperature range ΔT and for example with an increase in air temperature of 10 to 20°C this ratio is about 1:4. In this example it means that dry cooling needs four times more air than wet cooling. In other words, a larger heat exchange surface is required for dry cooling.

1.2 Approach

It is always important for a cooling system to provide sufficient driving force in order to achieve the transfer of heat. A minimal temperature difference is necessary between the incoming and the outgoing flow, i.e. the difference between the temperature of the process medium leaving the heat exchanger and the temperature of the coolant (water or air) that enters the heat exchanger, based on a counter flow design. This difference in temperature is called the *approach*. For wet cooling towers the approach is defined as the difference between the wet bulb temperature of the air and the temperature of the coolant leaving the tower. For dry cooling towers the approach is defined as the difference between the dry bulb temperature of the air and the temperature of the coolant leaving the tower.

A cooling system is designed to meet specifications throughout the year. Of course, when water and air temperatures are low, requirements are easily met. But higher temperatures can cause problems both in operations and for the environment. Through sustained lowering of process flow or sustained raising of the amount of cooling medium, the temperature specifications can eventually be met. There are, however, design limits to this approach. Systems are often

designed in such a way that specifications may be exceeded to a maximum of 5% or lower on an annual basis.

For water-cooling, a minimal approach over the heat exchanger of 3-5K is used. Lower values can be reached, but this requires a larger and therefore more expensive heat-exchanging surface. With more heat exchangers in a cooling system the different individual approaches have to be added up and the more exchangers the higher the approach. For a cooling tower an approach temperature of 7K to 15K is often used.

For condensers of power stations the term “thermal difference”, instead of approach, is used indicating the difference between the temperature of the condensate (steam) and the temperature at which the cooling water leaves the condenser. To calculate the temperature at which condensation can take place the terminal difference and the temperature increase of the cooling water have to be added. In case a cooling tower is used the approach of this tower will have to be added as well. For condensers practical experience shows minimal terminal differences in the range of 3-8K, also depending on the fouling factor [tm056, Caudron, 1991].

The minimum end temperature that can be achieved by a cooling system is determined by the approach of a cooling system and the design temperature, which depends on the climatic conditions of the site.

I.3 Capacity of a heat exchanger

The capacity or duty of a heat exchanger is the amount of heat that can be removed. The required heat transfer area of a cooling system is influenced by the different heat transfer capacities of the cooling media water and air, by sensible and latent heat transfer and by the driving force. The design has to consider material requirements, pollution, drop of pressure, flow speed, spatial restrictions and the volume to be cooled (fluid or vapour).

The total capacity of a cooling system is determined by adding up the duties (or capacities) of all heat exchangers:

$$Q_{tot.} = \sum Q_i [J/s \text{ or } W] \text{ with } Q_i = \text{duty of user } i$$

Due to its physical properties, water is an ideal heat carrier because of its high thermal capacity. It therefore only requires small heat exchange surfaces. The most effective transfer of heat is by evaporation of water. The latent heat (evaporation of water) compared with the specific heat capacity per ΔK at 30°C is about 630 times higher (Hv/C). The specific heat capacities of air, water, and evaporating water are shown in Table I.2.

Table I.2: Specific heat capacities of air and water

Air: (sensible heat transfer)	$C_p = 1005.6 + (16.03 \cdot 10^{-3} \cdot t)$	J/kg/K
Water: (sensible heat transfer)	C = 4192 C = 4182	J/kg at 10°C J/kg at 50°C
Evaporation of water: (latent heat transfer)	Hv = 2502 Hv = 2431	kJ/kg at 0°C kJ/kg at 30°C

I.4 Wet and dry bulb temperatures

The wet bulb temperature is the lowest temperature, to which air can be cooled down by adiabatic evaporation. The wet bulb temperature always lies below dry bulb temperature and depends on the measured temperature of the atmosphere, the humidity and the air pressure. The dry bulb temperature is the temperature of dry air and a very important factor in the design of air-coolers where sensible heat transfer is the underlying mechanism. Wet and dry bulb temperatures can be the same when ambient air is fully saturated.

For latent heat transfer the wet bulb temperature is the relevant temperature and it is theoretically the lowest temperature to which water can be cooled down. In case of wet cooling towers where the heat is transferred from the cooling water to the air mainly by evaporation, the wet-bulb temperature (i.e. the degree of saturation) is therefore an important design factor.

I.5 Relation between heat transfer and heat exchanging surface

A high heat transfer and driving force (approach) will require a relatively small surface, resulting in a compact and cost effective heat transfer concept. Because of the lower heat transfer capacity of air, dry cooling systems require much larger heat exchanger surfaces and driving force for the same cooling capacity. This larger heat exchange surface results in a higher demand on space and potentially higher investment costs against the absence of costs for water and cooling water treatment and the associated environmental effects.

The required heat exchanging area also depends on the medium that is to be cooled. As an example of this Table I.3 shows examples of heat transfer coefficients and the associated surface areas of various combinations of cooling water and process fluids.

Table I.3: Heat transfer coefficients and estimated surface areas A (m²) per MW and at 20K mean temperature difference for different industrial applications [Bloemkolk, 1997].

Hot process side	Heat transfer coefficient U (W/m ² K)	Estimated surface area ⁽²⁾ A (m ² per MW)
Fluids		
-organic solvent	250-750	200-600
-light oil	350-900	55-143
-heavy oil	60-300	166-830
-gases	20-300	166-2500
Condensing vapours ⁽¹⁾		
-water vapour	1000-1500	33-50
-organic vapour	700- 1000	50-71
-vacuum condensers (water)	500-700	71-100
-organics (partly condensing)	200-500	100-250
Notes:		
1. Starting point is $\Delta T(\ln)=20^{\circ}\text{C}$. Cooling with water. Calculation is based on overall heat exchange coefficient U and is meant as a comparison		
2. It should be taken into account that condensing vapours per kg drain off much more heat than cooling fluids; per MW heat discharged, relatively little vapour is therefore condensed.		
3. $Q=U.A.\Delta T(\ln)$		

As an example of what the above could mean two cases of installed cooling systems, one for dry cooling and one for evaporative cooling, are compared and the results are shown in Table I.4.

The dry cooling tower with a cooling surface diameter of 20% more, has only 47% of the capacity of the evaporative cooling system with an approach of 20 K compared to 12.6 K.

Table I.4: Effects of the cooling principle on the capacity, approach and cooling surface of a cooling system

[132, Eurovent, 1998]

Characteristics	Dry natural draught cooling tower	Wet natural draught cooling tower
Capacity	895 MW _{th}	1900 MW _{th}
Cooling surface diameter	145 m	120 m
Approach	20 K	12.6 K
Temperature (dry bulb / wet bulb)	14/ 10 °C	11/ 9 °C
Minimum end temperatures	34 °C	21.6°C

ANNEX II PRINCIPLE OF ENERGY SAVING THROUGH OPTIMISED COOLING

[tm059, Paping, 1995]

II.1 Subject

This Annex reviews a method of calculation of the potential energy conservation in the event that cooling is carried out at lower temperatures. The conservation is expressed in terms of primary energy, with a dimensionless unit of $\text{kW}_{\text{th}}/\text{MW}_{\text{th}}$ per K temperature difference in the cooling process itself. The reduction in energy consumption is achieved by the use of inhibitors that have been subjected to a standard test method. These inhibitors ensure that the water coolers remain cleaner during the summer months. The direct and indirect energy use because of the choice of any of the six main cooling systems in a specific area can also be calculated with this dimensionless number.

II.2 Summary of conclusions

- In practice the variable temperature gradients across fouling are of the order of magnitude of **1 to 4K**.
- Colder cooling water in the immediate vicinity of the pipe wall results in energy conservation of **$3\frac{1}{2} \text{ kW}_{\text{th}}/\text{MW}_{\text{th}}/\text{K}$** . This is equivalent with EUR 300 per MW_{th} cooling per annum per K temperature difference.¹
- The use of an efficient manner to combat the decrease in the heat transfer coefficient across fouling of heat exchangers results in a potential energy conservation for the European industrial sector pro ratio of this energy conservation factor. For every 100 GW_{th} cooling in Europe the energy conservation potential is **11 PJ_{th} per annum² per K**. This is equivalent to a reduction of the emissions of carbon dioxide of 700 thousand tons per annum per K for every 100 GW_{th} cooling in Europe.
- The involved energy consequences of the choice for each of the six main cooling systems are even more significantly. The difference in minimum attainable cooling water temperature for each of the six main cooling water systems can also be expressed in necessary energy expenditure to cool. The same “dimensionless” factor of $3\frac{1}{2} \text{ kW}_{\text{th}}/\text{MW}_{\text{th}}/\text{K}$ can be applied for comparison of the design alternatives.
- The use of certain inhibitors in cooling water results in significant energy savings. These savings can exceed the primary energy content of the additives by several factors of ten. The environmental impact decreases in proportion to these savings.
- The energy conservation achieved by the use of inhibitors exceeds the costs of the relevant additives by a very wide margin.

An illustration of both effects, as discussed in this Annex, is presented in Figure II.1. A lower temperature of the coolant as well as the use of antifouling treatment will effect the heat transfer through the exchanger wall and the waterfilm.

¹ Based on \$14.7 /barrel; with an energy value of 41.87 GJth/ metric tonne oil equivalent and 7.45 barrels/ metric tonne oil equivalent, representing 5.51 barrels per kWth year or 81 EUR /kWth year (Ministry of Economic Affairs, Netherlands, oil/gas conversion table NOVEM).

² PJth = Petajoule thermal = 10^{15} Joule.

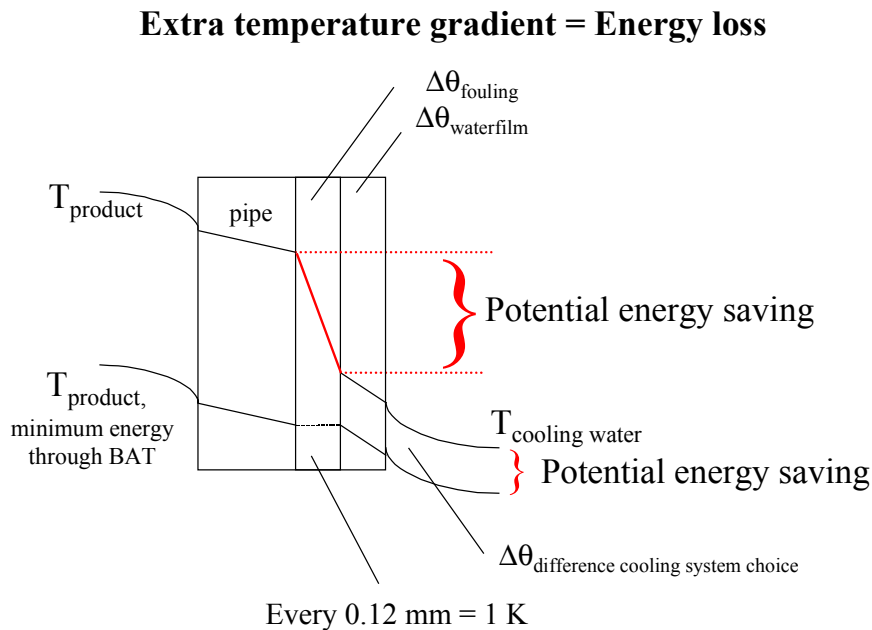

Figure II.1: Illustration of areas of potential energy saving by reduction of the temperature gradient through a fouling layer as well as by using colder cooling water influent

II.3 Introduction

Following many informal contacts a number of multinationals with branches in the Europe founded the industrial cooling-water group in 1991. They took the initiative to develop a standard test method for cooling-water inhibitors. The basis of this method was formed by the research carried out in the nineteen-eighties by DSM and Shell. The “Industrial Cooling-Water Project” was set up in the form of a joint project in which both the customers for and suppliers of these inhibitors participated.

The potential conservation in energy - in combination with the reduction in malfunctions of the production process achieved by the use of cleaner heat exchangers - was the most important motive for all partners to decide to invest in the project. This Annex discusses the issue in more detail.

The generation of shaft-power and/or electricity is always accompanied by cooling; this is necessary since only a maximum amount of useful energy can be extracted from a medium at any given ambient temperature. A proportion of this energy will pass through a number of process steps, and will ultimately reach the factory’s cooling-water system. The yearly averages³ for the standard direct energy consumption expended in cooling, expressed in terms of the ratio $KW_e / MW_{\text{th, cooling}}$ and assuming clean coolers in the summer months, is shown in the following table.

³ ASHREA Handbook, 1983 Equipment volume; American Society of Heating, Refrigeration and Air-conditioning Engineers Inc., Atlanta, USA, 1983.

Table II.1: Energy consumption in $kW_{e, \text{electricity consumption}} / MW_{th, \text{cooling}}$ with clean heat exchangers

Cooling water-system	Energy consumption in $kW_{e, \text{electricity consumption}} / MW_{th, \text{cooling}}$ with clean heat exchangers.		
	Σ	Cooling-water pump	Fan
Once-through cooling water	≈ 10 ; range 5 to 25	5 to 25	n/a
Circulation-cooling water with open wet cooling tower	≈ 15 ; range 10 to 25	5 to 20	5 to 10
Closed recirculating system	≈ 30 ; range 20 to 60	5 to 15	10 to 50

With an efficiency of the generation of electricity of 40%⁴ the above figures will need to be multiplied by 2.5 to express the energy consumption in terms of the primary energy carrier. The relative energy consumption required to cool by means of a water system then becomes dimensionless.

Moreover this energy consumption will increase in direct proportion to the (higher) temperatures of the cooling water and/or (increased) fouling of the coolers during the summer months. To calculate the indirect energy consumption in a more reliable way the previous tables in this document have to be linked. (The climatic conditions of the European countries mentioned in Table 1.6, and the technical and thermodynamic characteristics of the different cooling systems for industrial applications for a specific general site's climate mentioned in Table 2.1). The following table shows the lowest attainable water temperatures at inlet for the various cooling systems during the months of July and August in the Netherlands.

In practice virtually no tap water or groundwater is used for cooling. Moreover it is less desirable to make use of these kinds of water for this purpose, and the practice is gradually being discontinued. Consequently it is possible to state that once-through cooling-water systems located on the coast consume the least amount of primary energy.

Table II.2: Mean attainable lowest cooling water inlet temperatures for the various cooling systems during the months of July and August in the Netherlands.

Cooling system	Mean attainable min. temp.[°C]	Remarks; Netherlands as example
Once-through cooling: river	23	Local limitations of heat discharge by thermal limit values
Seawater along the coast	19	North sea 12 °C below mixing zone
tap-water	15	Cost price
groundwater	12	Limited stock
Open wet cooling tower	24	Wet bulb 19°C
Air cooling; (for comparison)	40 (product temp.)	Dry bulb 28°C

⁴ Central Bureau for Statistics, CBS, The Hague.

Moreover the energy consumption will increase when the heat exchangers are fouled. This sediment can be classified into microfouling and macrofouling. Blockages caused by shellfish and other solid sediment preventing the flow of water through the pipes may be regarded as macrofouling⁵. Microbial slime, scaling, deposits, that each in turn result in the formation of corrosion products on or in the warm cooling pipe, are all classified as microfouling⁶. A characteristic common to all the various forms of fouling mechanisms is the concomitant increase in the internal energy consumption.

This annex discusses the additional energy consumption per K extra temperature gradient in more detail as well as it presents the calculation basics for the direct and indirect energy consequences of the choice of each of the six cooling systems.

II.4 Calculations

II.4.1 Principles

Industrial cooling installation	$\Delta \theta_{\log}$	= 10	K	(= driving force)
	Φ_t	= 5	$\text{kW}_{\text{th}} \text{m}^{-2}$	(= heat flux)
consequently a	U_{total}	= 0.5	$\text{kW}_{\text{th}} \text{m}^{-2} \text{K}^{-1}$	(= overall heat transfer coefficient)

Assume a deposit	δ_{fouling}	= 0.12	mm	(= variable resistance)
with a	λ_{fouling}	= 0.6	$\text{W m}^{-1} \text{K}^{-1}$	(= thermal conductivity) ⁷

Heat transfer is conceived to be analogous to a series of resistances between the product to be cooled, the pipe wall, the laminar layer of water, and the variable degree of fouling:

$$\frac{l}{U_{\text{total}}} = \frac{l}{\alpha_{\text{product}}} + \frac{l}{\alpha_{\text{pipe wall}}} + \frac{l}{\alpha_{\text{water layer}}} + \frac{l}{\alpha_{\text{fouling}}}$$

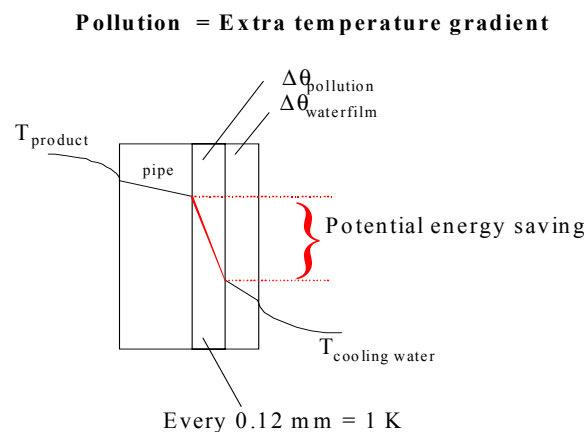

Figure II.2: Graphic representation of pollution factors responsible for extra temperature gradient over the pipe wall

⁵ Dutch experience with condenser maintenance, E.J. Sneek, H.A. Jenner, KEMA, Arnhem.

⁶ Practische waterbehandeling (Practical water treatment), Prof. J. Defrancq, de Sikkel Malle.

⁷ VDI-Wärmeatlas. Berechnungsblätter für den Wärmeübergang, sechste erweiterte Auflage, VDI-Verlag, Düsseldorf.

Relative heat transfer coefficients :

$$I = \frac{U_{total}}{\alpha_{product}} + \frac{U_{total}}{\alpha_{pipe\ wall}} + \frac{U_{total}}{\alpha_{water\ layer}} + \frac{U_{total}}{\alpha_{pollution}}$$

Relative temperature gradients :

$$I = \frac{\Delta\theta_{product}}{\Delta\theta_{log}} + \frac{\Delta\theta_{pipe\ wall}}{\Delta\theta_{log}} + \frac{\Delta\theta_{water\ layer}}{\Delta\theta_{log}} + \frac{\Delta\theta_{fouling}}{\Delta\theta_{log}}$$

Together :

$$\Delta\theta_{fouling} = \frac{U_{total}}{\alpha_{fouling}} * \Delta\theta_{log} = \frac{U_{total}}{\left[\frac{\lambda_{fouling}}{\delta_{fouling}} \right]} * \Delta\theta_{log} = \frac{0.5\ kW_t\ m^{-2}\ K^{-1}}{\left[\frac{0.6\ W\ m^{-1}\ K^{-1}}{0.12\ mm} \right]} * 10\ K = 1\ K$$

Consequently a

$$\Delta\theta_{fouling} = 1\ K$$

It is assumed that fouled water coolers in industrial installations have virtually no influence on energy consumption during the eight colder months of the year. This is based on the necessity of preventing certain process flows from being cooled to too low a temperature. Factories shall always keep at least one cooling-water pump in operation; a fan that has been stopped is incapable of a further reduction in its capacity. Savings can be achieved during a longer period of time in power stations. However, industrial cooling installations are usually deployed to cool a variety of products, and consequently exhibit a great variety in types of heat-exchange material. As a result of this diversity, industrial cooling installations have a need for an appropriate design of the use of inhibitors to accommodate their complex systems, in turn resulting in the utilization of the maximum benefits of the calculated energy conservation during only four months in a year. Consequently the calculations in this annex are restricted to this short period, and are applicable only to the cooling capacity of water systems used in industrial installations. The reason for these restrictions is that the interpretation of cooling-water additives would have been undermined if power stations had also been included in these calculations of the energy conservation.

In practice one or more “solutions” are used to remedy situations in which the design of the cooling system in combination with the inhibitor is incapable of supplying the required cooling capacity during the summer months. (These solutions are comprised of increasing the amount of cooling water and/or cooling air and/or the product temperature and/or the process pressure). All such solutions share the common characteristic of a concomitant increase in the internal energy consumption.

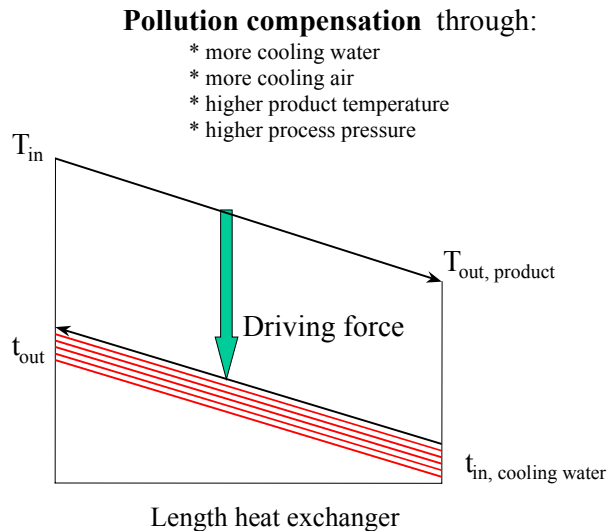

Figure II.3: Schematic representation of driving force over the length of a heat exchanger

In the following calculations the additional energy consumption resulting from microfouling is expressed in terms of a 1°C extra temperature gradient across the fouling. The formulae shown on the previous page indicate that an extra 1 °C temperature gradient already becomes apparent once a microbial slime layer has attained a thickness of no more than an order of magnitude of 0.12mm. This is also applicable to a layer of boiler-scale with a thickness of the same order of magnitude. The calculations assume that the heat transfer decreases linearly with the thickness of the fouling. The reduction in heat-exchanger capacity caused by the first 20% of blocked cooling pipes due to macrofouling can be compensated by increasing the required temperature gradient by 1°C. However every additional blocked cooling pipe will result in an exponential increase in the additional temperature gradient required.

Cooling tower discharging 10 MW _{th}	Φ	=	1000 m ³ h ⁻¹	circulation flow rate
	$\Delta \theta$	=	8.6 K	cooling water inlet/outlet
	$\Delta \theta_{\log}$	=	5.0 K	cooling tower cooling limit

II.4.2 Quantity of cooling water ↑

The following is an example of a calculation in which a 1K extra temperature gradient across microfouling is, in practice, compensated by an increase in the number of cooling-water pumps. The temperature and flow-rate of the product and the quantity of heat removed from the product remain constant. The average pressure drop is adjusted to 3.7 bar.

The capacity will be doubled by the parallel operation of two identical centrifugal pumps only in the event of a purely static pressure. However every successive cooling-water pump brought into operation in a cooling-water system will result in a change of the dynamic head characteristics. As a consequence of these changes the nominal capacities of the pumps may not be totaled. The resultant reduction in the capacity requires increased power consumption⁸.

The removal of an equal quantity of heat requires the circulation of an extra 10% of cooling water (= 20% extra pump energy) to compensate for the extra 1 K temperature gradient:

⁸ Pompen (Pumps), L.W.P. Bianchi, Stam, Culemborg.

More cooling water >> increased pumping power

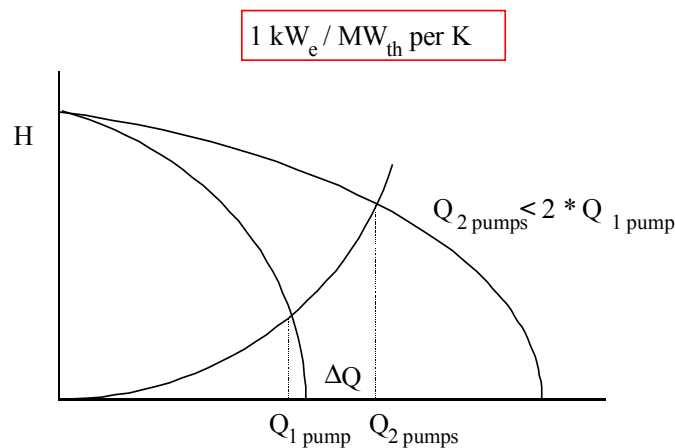

Figure II.4: Number of cooling water pumps and change of cooling water low due to fouling

$$\begin{aligned}
 W \text{ is } \frac{\Delta\varphi * P}{\eta} &= \frac{20\% * \Phi * [\rho * g * \Delta H]}{\eta} \\
 &= \left(\frac{20\% * \frac{1000 \text{ m}^3/\text{h}}{3600 \text{ s/h}} * \left[1000 \frac{\text{kg}}{\text{m}^3} * 9.8 \frac{\text{m}}{\text{s}^2} * 37 \text{ m water gauge} \right]}{0.7} \right) \\
 &= \frac{20 * 10^3}{0.7} \left[\frac{\text{kg} \cdot \text{m}}{\text{s}^2} * \frac{\text{m}}{\text{s}} \right] \\
 &= 30 * 10^3 \left[\frac{\text{Nm}}{\text{s}} \right] = 30 \text{ kW}_e \text{ per } 10 \text{ MW}_{th} \text{ cooling.}
 \end{aligned}$$

Corrected for 4 summer months per year:

on an annual basis 1 kW_e / MW_{th} per K

II.4.3 Quantity of cooling air ↑

The same cooling tower of 10 MW_{th} is used, but the removal of the same quantity of heat is now achieved by compensating for the 1 K extra temperature gradient across the microfouling by increasing the quantity of cooling air the fans pass through the cooler. The power consumption of the fan increases from 54 kW_e to 83 kW_e per 10 MW_{th}⁹:

⁹ Calculation from POLACEL, Doetinchem (NL), and practical experience with variable pitch in combination with start/stop of one or more fans.

Corrected for 4 summer months per year:

on an annual basis $1 \text{ kW}_e / \text{MW}_{\text{th}}$ per K

Conclusion: an increase of either the amount of cooling air or the cooling-water flow rate requires the same annual amount of extra energy.

II.4.4 Product temperature \uparrow ; gas volume \uparrow

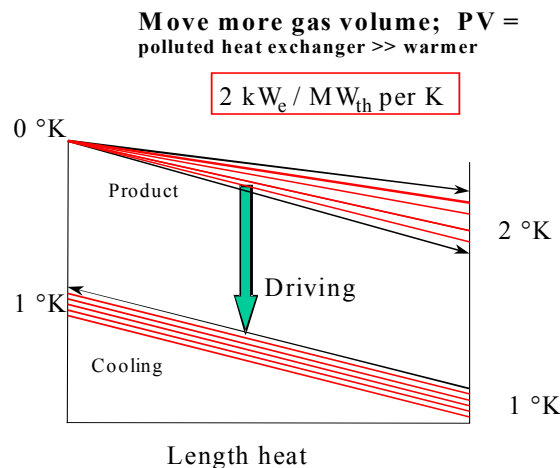

Figure II.5: Change of temperature gradient of product gas (moles) in a counter flow heat exchanger due to fouling

The inlet temperature of the product is assumed to be constant. This means that the decrease in the outlet temperature of the product discharged from a fouled heat exchanger will be less than that from a clean heat exchanger. The temperature gradient across the fouling will be virtually uniformly distributed along the entire length of the heat exchanger. As a result of these two effects the reduced temperature drop of the product at the outlet of the fouled heat exchanger will be twice the magnitude of the temperature gradient across microfouling on the waterside of the heat exchanger. A pure countercurrent heat exchanger in which the energy content per K temperature change of the cooling-water flow rate (= in fact the specific heat of a quantity) is greater than that of the product to be cooled will exhibit convergent temperature profiles at the outlet side of the heat exchanger. The reduced temperature decrease on the product-outlet side caused by microfouling on the waterside will consequently be less than 2 °C per K temperature gradient across the fouling. Conversely, energy content per K temperature change of the cooling-water flow rate smaller than that of the product to be cooled will result in divergent temperature profiles at the outlet side of the heat exchanger. The reduced temperature decrease on the product-outlet side caused by the same microfouling on the waterside will then be in excess of 2 °C per K temperature gradient across the fouling on the water-side.

Under conditions of adiabatic compression, at a constant product mass and compression ratio, the removal of the same quantity of heat is now achieved by compensating for the extra 1K temperature gradient across the microfouling by increasing the final temperature of the product to be cooled by 2 °C .

The formula for the same cooling tower of $10 \text{ MW}_{\text{th}}$ will than be:

$$W = \int_{P_{in}}^{P_{out}} V * dP = \varphi_v * R * T_{in} * \frac{\kappa}{\kappa-1} * \left[\left(\frac{P_{in}}{P_{out}} \right)^{\frac{\kappa-1}{\kappa * \eta_{pol}}} - 1 \right]$$

= compressorwork is a linear function of the inlet- gastemperature.

= per 2 °C product temperature increase $\rightarrow \frac{T_{in+2^\circ C}}{T_{in}}$ extra compressor power consumption

$$= \left(\frac{273 + 27}{273 + 25} \right) - 1 = 0.67 \text{ percent more compressor work per } 2^\circ C$$

Corrected for 4 summer months per year:

on an annual basis 2 kW_e / MW_{th} per K

Conclusion: the displacement of volume is more expensive than mass transport.

II.4.5 Product pressure ↑; cooling compressor ↑

For the same cooling tower of 10 MW_{th}, where, for the same mass flow rate, the removal of the same quantity of heat is now achieved by means of product condensation (for example, for the benefit of a refrigerating machine based on adiabatic compression and expansion). This will raise the process-pressure of the product to be cooled so as to compensate for the 1K extra temperature gradient across the microfouling:

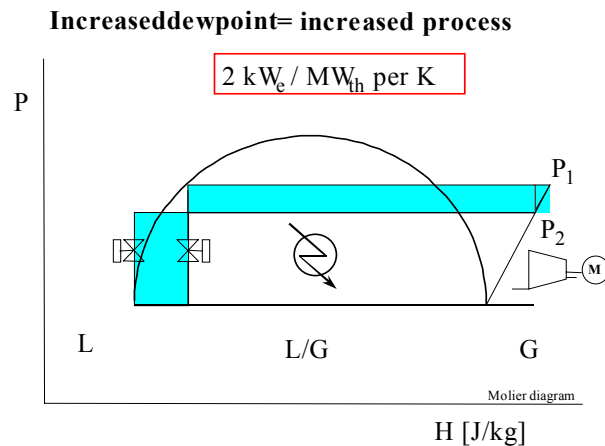

Figure II.6: Representation of increase of process pressure to compensate temperature increase due to fouling

Assumptions:	propene-refrigerating machine	
	inlet and outlet pressures	1.9 and 13 bar respectively
	boiling points	- 33.6 and 28.5 °C respectively
	pressure-temperature gradient	0.33 bar K ⁻¹
	compressor and turbine efficiency	0.66

$$\text{Cooling factor Carnot Cyclus} = \left[\frac{\theta_{in}}{\theta_{in} - \theta_{out}} \right]_{in} = \left[\frac{273.15 - 33.64}{28.50 - (-33.64)} \right]_{at 28.5^\circ C} = 3.852$$

$$\text{Cooling factor difference} = \frac{\left[\frac{\theta_{in}}{\theta_{in} - \theta_{out}} \right]_{in}}{\left[\frac{\theta_{in}}{\theta_{in} - \theta_{out}} \right]_{in+1^\circ C}} = \frac{\left[\frac{273.15 - 33.64}{28.50 - (-33.64)} \right]_{at 28.5^\circ C}}{\left[\frac{273.15 - 33.64}{29.50 - (-33.64)} \right]_{at 29.5^\circ C}} = \frac{63.14}{62.14} = 1.0151$$

$$\text{Extra compressor power cons.} = \frac{1 - 1.0151}{3.852 * 0.66} = 0.594 \text{ percent per K}$$

Corrected for 4 summer months per year:

On an annual basis 2 kW_e / MW_{th} per K

Conclusion: “Frigories” are twice as expensive as calories.

II.5 Total potential energy conservation per °C colder cooling-water boundary layer

II.5.1 Efficiency of power generation ↑

The efficiency of the generation of electricity in the Netherlands is 40%¹⁰.

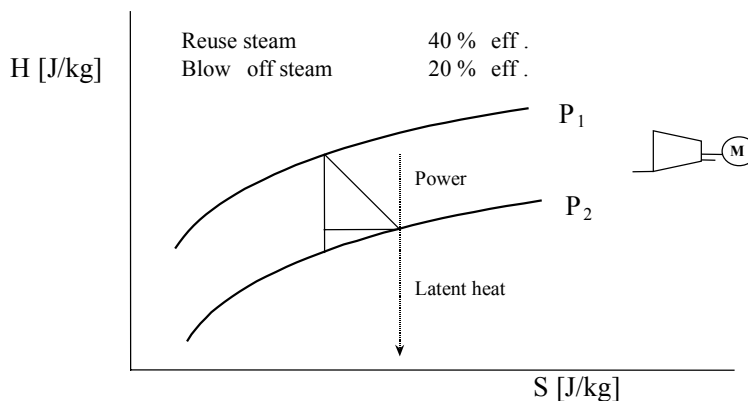

Figure II.7: Efficiency power generation for pumps, fans and compressors

The generation and consumption of steam in a petrochemical complex are usually in balance during the autumn and the spring. In the winter high-pressure and medium-pressure steam will be diverted to the low-pressure steam network. Conversely, in the summer some of the low-pressure steam will be disposed of by blowing it off to the atmosphere and/or condensing it in

¹⁰ Central Bureau for Statistics, CBS, The Hague.

coolers. Moreover a number of steam pumps will be shut down, and some electric motors will be started up, so as to compensate for the shift in the energy balance.

Steam turbines are also used as auxiliary turbines to power refrigerating machines. In such situations the extra low-pressure steam produced and exhausted during the summer (the additional amount generated as a result of fouled product condensers) will be disposed of. The extra energy consumed by the refrigerating machine will then be accompanied by extra energy losses, which will be a magnitude of 5 larger. The enthalpy of superheated high, medium and low-pressure steam is only one-fifth higher than the latent heat of water.

The Dutch Industry uses 20% of the total cooling capacity for compressor gas and refrigerated cooling¹¹. Half of this refrigerated cooling is carried out by means of (auxiliary) steam turbines. “Frigories” (or “negative” calories) are more expensive than calories, and volume displacements are more expensive than mass transport. In practice this means that during the summer months preference will be given to starting up cooling-water pumps and fans earlier, and shutting them down later, rather than increasing the process pressures. Furthermore, in the first instance 80% of the capacity lost by inefficient cooling due to fouling will be compensated by means of start/stop commands to motors.

Consequently the average increase in primary energy per K temperature gradient is:

$$\left(\frac{80\% * 1}{0.4}\right) + \left(\frac{10\% * 2}{0.4}\right) + \left(\frac{10\% * 2}{0.2}\right) = \underline{\underline{3.5 \text{ kW}_{\text{th}} / \text{MW}_{\text{th}} \text{ per K}}}$$

Note: The above expressed energy factor can be calculated for other European countries as well, if the relative cooling capacity for compressor gas and refrigerated cooling is known. It is expected that the outcome will range between 3 and 4 kW_{th} / MW_{th} per K, since the power generation efficiency in Europe is also around 40%.

II.5.2 Total water used for cooling in the Dutch industry (excl. power plants)

Numbers regarding cooling water consumption, have to be available to calculate the absolute direct and indirect energy usage as well as the absolute environmental impact of each of the six main cooling systems on a European scale. In the Netherlands, these statistical data were available with a spread over the last decades. The majority of the water consumed by the national industry (= 3.1 * 10⁹ m³ per annum) is destined for use in cooling. The total amount of water used for cooling purposes amounts to **2.7 * 10⁹ m³ per annum** (for power plants 8.3*10⁹ m³ p.a.). Of this water the majority is fresh, salt or brackish surface water. The original statistical sources differentiate between water used for general purposes and for cooling. However this data makes no differentiation between the proportions of water used to feed recirculating and once-through cooling-water systems. Calculations indicate that the amount of heat removed by water systems in the Dutch industrial sector is of the order of magnitude of **180 PJ_{th} per annum**¹² (= 5.7 GW_{th}¹³) and equally partitioned between cooling towers and once through systems.

¹¹ EST Consult B.V., Woubrugge, December '90, NESR003. Marktonderzoek naar het elektriciteitsverbruik en de mogelijkheden van elektriciteitsbesparing in de Nederlandse industrie (Market research into the electricity consumption of the Netherlands industry, and opportunities for electricity conservation).

¹² CBS, Heerlen: key figure K-261/1991; water provisions for companies 1991, and every five years previously from 1957. CBS, Voorburg; key figure K-117/1992-1 & -2; Dutch energy consumption, annual figures 1992 and the prior decades from 1972.

¹³ Also verified with data from:

- Emissie Registratie warmte via water E 260 tot en met de 6^e ronde (registration of heat emissions via E260 water up to and including the 6th round (for the most important companies from an environmental perspective) in the 1990's); RIVM, Bilthoven.
- Author's survey of the top ten companies in the Netherlands; data RIZA; Lelystad, Netherlands.

II.5.3 Total potential energy conservation per °C colder cooling-water boundary layer

The figure of 180 PJ_{th} per annum, removed by cooling-water systems, in combination with an average extra annual energy consumption of the order of magnitude of **3½ KW_{th} / MW_{th} per °C** colder cooling-water boundary layer, would result in a potential energy conservation for the Dutch industrial sector amounting to:

0.63 PJ_{th} per annum per °C

Or in financial terms:

EUR 1.6 million per annum per °C

Assuming that the Dutch situation represents only 5% of the European industrial production capacity where cooling is involved, it can be estimated that the cooling capacity in Europe applied by industry is in the magnitude of 120 GW_{th}, where power plants cool 200 GW_{th}. For the whole cooling sector in Europe the potential energy conservation would then amount to:

35 PJ_{th} per annum per °C

Or in financial terms:

EUR 100 million per annum per °C

II.6 Examples of calculations for the relative conservation of energy and reduction of the environmental impact achieved by the use of inhibitors

II.6.1 The contribution made by oxidation

The following is an example of the use of inhibitors based on oxidants such as sodium hypochlorite (because this is a relatively well-known degradable additive):

Assumptions:

Basis:

electrolyte (or bulk purchase)	2.2	KWh _e / kg chlorine equivalent
- production efficiency	0.7	W _e / W _e
- thermal efficiency	0.4	W _e / W _{th}
- concentration	15	%

cooling installation

- thickness of slime layer	0.5	mm (no inhibitor in summer)
- boundary-layer temperature gradient	4	K
- average "conservation ratio"	3.5	kW _{th} / MW _{th} /K

use of inhibitor

- influent $\approx 1.0 \text{ mg l}^{-1}$, stoichiometric oxidation,
- effluent $\leq 0.1 \text{ mg l}^{-1}$, active chlorine
- intermittent chlorination, such as 4 hours in use/out of use
- 1% conversion of dosed chlorine equivalent to halogenated by-products also expressed as chlorine equivalent which amounts to approximately to 3% of brominated hydrocarbons [tm160, Bijstra, 1999].

II.6.1.1 Once-through cooling system

usage of hypochlorite	300	kg Cl/MW _{th}	[tm160, Bijstra, 1999] ¹⁴
costs of hypochlorite	114	EUR / metric tonne in tank truck	

Consequently both the energy conservation ratio¹⁵ and the performance-price ratio of the inhibitor are of overriding importance. The use of this oxidant achieves environmental energy conservation several factors of tens in excess of the primary energy content of the inhibitor.

The environmental energy yield of this inhibitor is more than a factor 10 higher than the financial conservation¹⁶.

The use of hydrogen peroxide or ozone will result in a decrease of the above-mentioned ratios.

¹⁴ Based on chlorine demand in the north-west European delta.

¹⁵ The energy conservation ratio is a dimensionless number that compares the energy conservation achieved by the use of the inhibitor with the primary energy content of the relevant additive.

¹⁶ The financial conservation ratio is a dimensionless number that compares the financial conservation achieved by the use of the inhibitor with the cost of the relevant additive.

Energy conservation ratio =

$$\left(\frac{8760 \text{ hr/yr}}{300 \text{ kg "as chlorine" per annum} / MW_{th}} \right) * \left(\frac{3.5 \text{ kW}_{th} / MW_{th} \cdot K * 4K}{\left(\frac{2.2 \text{ kWh}_e / \text{kg chlorine}}{0.7 W_e / W_e * 0.4 W_e / W_{th}} \right)} \right) = 52 \frac{J_{output}}{J_{input}}$$

Financial conservation ratio =

$$\left(\frac{14 \text{ kW}_{th} / MW_{th}}{2 \text{ mt hypochlorite} / \text{year per } MW_{th} \text{ cooling}} \right) * \left(\frac{\text{EURO } 81 / \text{kW}_{th} \text{ per year}}{\text{EURO } 114 / \text{mt}} \right) = 5 \frac{\text{EURO}_{output}}{\text{EURO}_{input}}$$

Note: mt = metric tonne(s)

The dimensionless environmental energy ratio can be supplemented by the calculation of an additional relative environmental load mass ratio. This also indicates the energy conservation achieved by the use of inhibitors, but now expressed in terms of the ratio of the reduction in the emissions of carbon dioxide to the production of unwanted precursors as a result of oxidative side reactions.

Environmental mass ratio =

$$52 \frac{J_{output}}{J_{input}} * \frac{\left(\frac{1.94 \text{ kg CO}_2 / \text{Nm}^3 \text{ natural gas}}{31.6 \text{ MJ}_{th} / \text{Nm}^3 \text{ natural gas}} \right)}{\left(\frac{3\% \text{ conversion to halogenated ones}}{\left(\frac{2.2 \text{ kWh}_e / \text{kg chlorine} * 3.6 \text{ MJ}_{th} / \text{kWh}_{th}}{0.7 W_e / W_e * 0.4 W_e / W_{th}} \right)} \right)} = 3000 \frac{\text{CO}_2}{C - X}$$

However the quantity obtained from this formula is not entirely dimensionless. The environmental mass ratio can be introduced for the estimation of the total environmental effect ratio, for instance, by introducing the effect ratio of specific chlorinated by-products in seawater, such as bromoform (84%), dibromo-acetonitril (10%) and trihalomethanes, such as dibromochloromethanes and bromodichloromethanes (5%) [tm157, Jenner et al, 1998].

Their unwanted formation, which is linear with the amount of chlorination of the system, can then be compared with the resulting reduction in the amount of energy used, when both are expressed in units of CO₂ and its corresponding ozone depleting effect.

II.6.1.2 Open recirculating system

water volume; basin + pipes	50	m ³ / MW _{th}
metering (for 3 mg/m ³)	1.0	l h ⁻¹
metering time, <u>dis</u> continuous	1.0	h / day
costs of hypochlorite	160	EUR / metric ton in 1 m ³ multi box containers

For continuous dosage regimes and/or less adequate process controlled dosages approximately 3-times more chlorine-equivalents per MW_{th} are required.

Energy conservation ratio =

$$\left(\frac{1 MW_{th} h * 24 \text{ hours/day}}{1 l \text{ hypochlorite/day}} \right) * \left(\frac{3.5 kW_{th} / MW_{th} \cdot K * 4K}{\left(\frac{15\% * 2.2 kWh_e / kg \text{ chlorine}}{0.7 W_e / W_e * 0.4 W_e / W_{th}} \right)} \right) = 285 \frac{J_{output}}{J_{input}}$$

Financial conservation ratio =

$$\left(\frac{14 kW_{th} / MW_{th}}{365 l \text{ hypochlorite/year per } MW_{th} \text{ cooling}} \right) * \left(\frac{EURO 81 / kW_{th} \text{ per year}}{EURO 160 / \text{metric tonne}} \right) = 20 \frac{EURO_{output}}{EURO_{input}}$$

The energy conservation ratio and the performance-price ratio of the same oxidant used in a circulation system are higher than those for a once-through cooling system. Conversely the consumption of primary energy required to cool by means of a recirculating system is higher than that of a once-through cooling system. Consequently most of the largest power stations are located in the vicinity of the coast.

The relative environmental load mass ratio can also be calculated for this system.

Environmental mass ratio =

$$285 \frac{J_{output}}{J_{input}} * \frac{\left(\frac{1.94 \text{ kg } CO_2 / Nm^3 \text{ natural gas}}{31.6 \text{ MJ}_{th} / Nm^3 \text{ natural gas}} \right)}{\left(\frac{3\% \text{ conversion to halogenated hydrocarbons}}{\left(\frac{2.2 kWh_e / kg \text{ chlorine} * 3.6 \text{ MJ}_{th} / kWh_{th}}{0.7 W_e / W_e * 0.4 W_e / W_{th}} \right)} \right)} = 16000 \frac{CO_2}{C - X}$$

Once again, the mass ratio between the required reduction of emissions of carbon dioxide and the unrequired emission of halogenated hydrocarbons of the same oxidants – but now applicable to a recirculating cooling system – is higher than that of a once-through cooling system. Conversely, the consumption of primary energy by a cooling-tower system is higher than that of a once-through cooling system.

II.7 Examples of calculations of the relative savings in energy with colder cooling water

II.7.1 Coastal water versus cooling towers

<i>Assumptions</i> ¹⁷ :	-influent temperature	coastal water	19	°C
		cooling tower	24	°C
	effluent pressure	once-through cooling system	1	mwg
		cooling tower system (height of tower + nozzle)	14	mwg

Raising the cooling water to an additional height and then spraying it through the nozzle results in an additional power consumption of the pump per MW_{th} heat removed by means of a cooling tower system:

$$\begin{aligned}
 W &= \frac{\Delta\varphi * P}{\eta} = \frac{\varphi * [\rho * g * \Delta H]}{\eta} \\
 &= \frac{\frac{100 \text{ m}^3 / \text{h}}{3600 \text{ s} / \text{h}} * \left[1000 \frac{\text{kg}}{\text{m}^3} * 9.8 \frac{\text{m}}{\text{s}^2} * 13 \text{ mwg} \right]}{0.7} \\
 &= \frac{3.6 * 10^3}{0.7} * \left[\frac{\text{m}}{\text{s}} * \frac{\text{kg} \cdot \text{m}}{\text{s}^2} \right] = 5 * 10^3 \left[\frac{\text{Nm}}{\text{s}} \right] = 5 \text{ kW}_e \text{ per MW}_{th} \text{ cooling}
 \end{aligned}$$

The power consumption of the pump expressed in terms of primary energy throughout the entire year is
The cooling water is on average 5 °C warmer, so

12.5 kW_{th} per MW_{th} cooling
17.5 kW_{th} per MW_{th} cooling

Together, a difference in the energy consumption of

30.0 kW_{th} per MW_{th} cooling

Consequently in the light of the benefits to energy conservation large cooling systems are, in practice, preferably built in the form of once-through cooling systems on the coast.

II.7.2 River water versus cooling towers

The temperature difference of a once-through cooling system, supplied with river water, in comparison with a cooling tower is in the order of magnitude of about 1 K. Together with the maintenance of the necessary pressure difference across the cooling water the total difference in energy consumption amounts to **16 kW_{th} per MW_{th} cooling**.

¹⁷ Onderzoek industrieel waterverbruik (Survey of industrial water consumption), final report, F.C.A. Carner, Krachtwerktuigen Amersfoort, 1992.

Samenwerkende Rijn- en Maas waterleidingbedrijven 1980 – 1992, RIWA, Amsterdam.

Jaarboeken monitoring Rijkswateren (State Water Monitoring Annuals) from 1980.

II.7.3 Groundwater versus cooling tower

The temperature difference of a once-through cooling system supplied with groundwater in comparison with a cooling tower is the largest, i.e. 12 K. The total difference in energy consumption required for cooling is then **42 kW_{th} per MW_{th}** cooling. It was assumed that the power consumed by a pump that pumps up groundwater is of the same order of magnitude as the power required to maintain a cooling-tower effluent pressure difference. However, the limited availability of groundwater restricts the use of this way of energy conservation.

II.8 Appendix environmental impacts

Table II.3: Conservation ratios for once-through and recirculating cooling system

Type of cooling system	Energy- Conservation ratio	Financial- Conservation ratio	Mass- Ratio environment
	$J_{\text{output}} / J_{\text{input}}$	EUR _{output} / EUR _{input}	CO ₂ / C-X
Once-through cooling system	52	5	3000
Open recirculating cooling system	285	20	16000

Table II.4: Energy conservation with potential colder cooling water source

System comparison	kW _{th} per MW _{th}	Remarks
Coastal waters versus cooling towers	30	geographically specified
Riverwater versus cooling towers	16	local thermal burden
Groundwater versus cooling towers	42	limited stock

The above-presented numbers can be used to show the outcome for specific areas in Europe, like for instance a high-industrialised area like the Netherlands. The replacement of all industrial cooling towers by once-through cooling systems supplied with river water would result in a national energy conservation of 91 PJ_{th}¹⁸ * 16 kW_{th}/MW_{th} = 15 PJ_{th} per annum (equivalent to a reduction of the emission of carbon dioxide of 93000 metric tonnes per annum). This would require the availability of 85 m³/sec river water throughout the entire year. Conversely, only those cooling systems located at a relatively small distance from a river would come into consideration for such a replacement; the distances otherwise involved would negate the energy advantages offered by the use of this source of water. So it isn't surprising that most industries and power stations are located nearby rivers and coastal areas, emphasising the importance of a proper cooling design and location choice.

¹⁸ Water symposium 1995; syllabus 43, Nederlands Corrosie Centrum Bilthoven.

ANNEX III SHELL AND TUBE HEAT EXCHANGERS FOR INDUSTRIAL ONCE-THROUGH COOLING SYSTEMS AND THE OCCURRENCE OF LEAKAGE

The design of the heat exchanger is extremely important, as it is the key element of a cooling system, where the exchange of heat takes place. From an environmental point of view it is there, where leakage from process substances to the coolant can occur. In once-through cooling systems the relevance of a well designed, operated and maintained heat exchanger is obvious. From a preventive approach attention should be paid to the issues presented in this Annex before considering a move towards an indirect (secondary) system. This Annex gives a summary of a number of important issues to take into account in the design of the commonly used shell and tube heat exchanger to avoid environmental problems [tm001, Bloemkolk, 1997]

The shell and tube heat exchanger consists of a shell, a great number of parallel tubes, tube plates (tube sheets) baffles and one or two heads. Heat exchange between the media takes place by pumping the one medium through the tubes and the other medium around the tubes. As this happens the heat is transported through the tube wall. Diagonally on the tubes are baffles. The baffles ensure a better transfer of heat (through increased turbulence of the flow around the tubes) and support the tubes. The shell & tube heat exchanger is reproduced in a picture below.

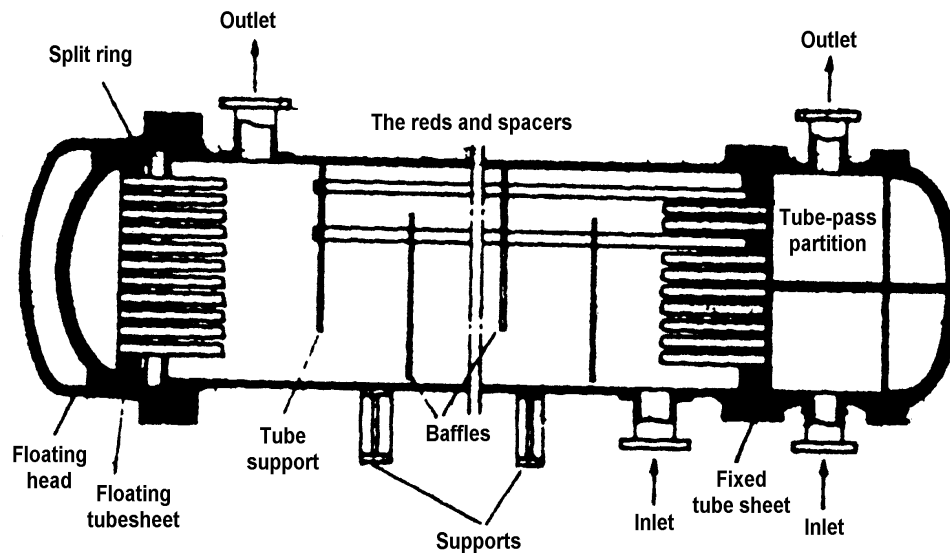

Figure III.1: Major components of shell & tube heat exchanger [tm001, Bloemkolk, 1997]

There are a great many different types of shell & tube heat exchangers. By making the right choice from the design parameters below, the design can be adapted to the specific process and maintenance requirements:

- the type of shell and head
- the type of tube (straight or U-shaped, with or without fin)
- the size of the tube (diameter and length)
- the distance between the tubes (pitch) the configuration (lay-out)
- the number of baffles the type of baffle
- the distance of the baffle (baffle pitch)
- the number of passes through the tubes (tube passes)
- the flow pattern (counter flow, concurrent flow)
- either mechanical or not, cleaning either with (high pressure) water or not

The Tubular Exchanger Manufacturers Association (TEMA) has drafted a nomenclature for the various types of shell & tube heat exchangers. TEMA has also drafted mechanical design guidelines.

The advantages and disadvantages of the shell & tube heat exchanger are listed below.

Advantages:

- available for all applications
- available in almost all materials
- wide range of flows and capacities (duties)
- sturdy, safe construction
- good thermal and mechanical design methods available

Disadvantages

- relatively expensive per m² heat exchanging surface area
- not optimal for heat transfer
- cleaning (drawing the tube bank) of the shell side is laborious

Because of the sturdy and safe construction of the shell & tube heat exchanger, refineries prefer this type of heat exchanger. The choice of this type of shell & tube heat exchanger for once-through systems is explained further below.

III.1 Design of the shell & tube heat exchanger for one through systems

As a rule, the shell & tubes of the TEMA-type AES are used for once-through systems. The cooling water flows through the tubes and the process medium through the shell. AES refers to the codes used to describe the different options for shell and tube heat exchangers (Figure III.2)

Allocation media

Because the tube side of the shell & tube heat exchanger can be cleaned easier and better than the shell side, heavy fouling media are allocated to the tube side. Because of the use of corrosion-resistant materials for corrosive cooling water, it is also more economic to have the cooling water flow on the tube side.

A-Type of front end head

Opening the shell & tube heat exchanger for inspection and maintenance is easiest with an A-type 'front end head', because the connecting tubes do not need to be dislodged when opening this type of head. For this reason, this type of head is almost always used for heat exchangers with a "polluting" medium on the tube side.

E-Type of shell

The choice for the type of shell depends on the process requirements for the medium on the shell side. Usually, the E-type is chosen ("one-pass-shell").

S-Type of rear end head

The choice of the type "rear end head" is determined by factors relating to:

- the need to clean (mechanically or with water) the shell side
- the need to clean (mechanically or with water) the tube side
- quality of the cooling water (corrosive, scaling, etc.)
- occurrence of thermal expansion between shell and tube material
- need for counterflow

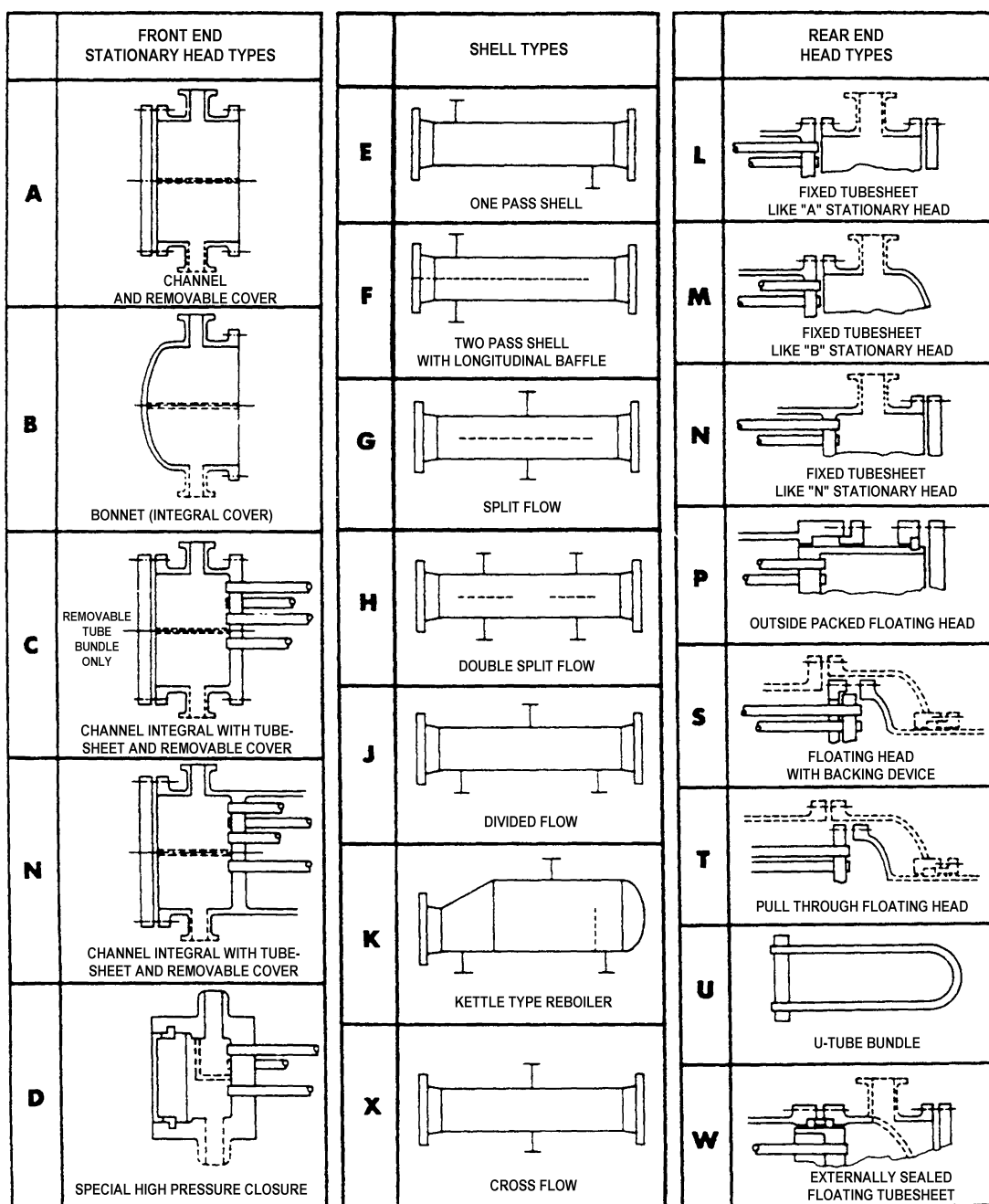

Figure III.2: Heat exchanger nomenclature (Standards of the tubular Exchanger Manufacturers Association)

[tm003, Van der Schaaf, 1995]

Usually the S-type ('floating head' type) is chosen because this type can be cleaned mechanically (or with water) on both the shell and the tube side. There are also no problems with this type in the event of thermal expansion differences between the shell and tube material. However, the S-type is the most expensive type of 'rear end head'.

III.2 Leakage in shell & tube heat exchangers

Leakage, and with it contamination of cooling water by the process medium, occurs in shell & tube heat exchangers in most cases as a result of flaws in the tube-tube plate connection, flaws in the tube itself and flaws in the flanged connection that separates both flows ('floating head'). Leakage can occur primarily as a result of:

1. poor design (about 30% of the cases)
2. poor manufacturing
3. operation that is not within the limits of the design (50-60%)
4. poor inspection and maintenance

1. Poor design

Because a wrong or poor design irrevocably leads to leakage, during the design phase careful thought must be given to the design parameters below:

- choice of material
- choice of tube-tube plate connection (rolled or welded)
- choice of packing type
- type of detail on packing faces
- design of the flanges (thickness, no rotation)
- design of the tube plate (thickness, no bending)
- design of tube support

In this consideration, attention should be given to the 'operating' conditions. They are:

- occurrence of vibration
- thermal expansion differences
- flow division
- flow speeds

Poor design also includes wrong design of flow speeds and design based on incorrect data.

2. Poor manufacturing

A good design, however, is not sufficient to prevent leakage. Poor manufacturing can also lead to leakage during operation of the heat exchangers. During manufacturing, the following aspects play a role when it comes to prevention of leakage:

- tightening procedure of the flange bolts
- smoothness of the treatment of the packing surfaces
- tube hole diameter and tolerance in tube plates and baffles
- rolling or welding procedure for tube-tube plate connection

3. Operation that is not in keeping with the design

Operations that differ from the operating conditions for which the heat exchanger has been designed can lead to damage and ultimately to leakage in the heat exchanger.

Different operation could be:

- thermal shocks
- 'upset' condition such as over-pressure and/or too high temperature
- increased or reduced through-flow of flows
- vibrations
- mussels in tubes (which have become detached from the cooling water tube) combined with vibrations

In addition, incorrect treatment can occur during maintenance, for instance during cleaning of the tubes with steam or warm water (damage as a result of thermal expansion).

4. *Poor inspection and maintenance*

During periodic maintenance, the heat exchanger is opened up and the tube bank is pulled, cleaned and inspected. Inspection aimed at detecting and/or preventing leaks includes control of:

- corrosion and/or erosion on the inside and outside of tubes and tube-tube plate connection
- corrosion of packing faces of the flanges
- size of tube holes in baffles (has the diameter of the openings increased in size?)
- reduced wall thickness of the tubes (special attention must be given to tube ends, tubes located at baffles and tube corners)
- bent, twisted or torn off tubes
- tubes pressing against each other, loose tubes
- bent tube plates
- small cracks (or perforations) in tubes and welded tube-tube plate connection
- smoothness and condition of packing faces

Periodic maintenance always ends with a water pressure test, whereby parts of the heat exchanger are pressurised to verify that the heat exchanger is still suitable to operate under the desired pressure levels. In this way, too, the tubes, tube-tube plate connections and flange connections are tested for leaks. To detect leaks, more accurate testing methods are also available. Air ('air and soapy water' test) or helium is used. If flaws or suspicious areas are found, their cause will need to be investigated. Once the cause has been found, corrective measures will need to be taken. If this is not done, and this applies to dealing with the cause as well as the repair of the parts, there is a large probability of (new) leaks in the future.

Corrective measures include the plugging of tubes and replacing gaskets. If a company has its own workshop, the repair work on a shell & tube heat exchanger will take one to two days. By emphasising preventive rather than corrective maintenance, leaks can be prevented. For instance, tube banks can be replaced sooner. Proper logging of maintenance works done and of the occurrence of problems enables better planning of maintenance work. It is recommended that the closing of the heat exchanger and tightening of the bolts is done under supervision to prevent future leaks. For this, a tool with a regulated momentum can be used.

III.3 Alternatives

The probability of leakage can be reduced by alternative choices of material, TEMA-type, tube plate connection, type of packing and the level of the process pressure of the cooling system.

Choice of material

Instead of carbon steel, more high-grade materials such as aluminium-brass copper nickel and titanium can be used for the water side of the heat exchanger. This will make the heat exchanger considerably more expensive than a heat exchanger whose tubes and tube plates are made of carbon steel (See also Annex IV).

Different heat exchanger

By choosing another type of heat exchanger, the probability of leakage can be reduced by a considerable margin.

Alternatives are:

- a U-tube heat exchanger
- a heat exchanger with a double tube plate construction
- both U-tube and double tube plate construction

There is no floating head on the U-tube type heat exchanger and therefore no flange seal on the rear end head. The U-tube type is 10 to 15% cheaper than the floating head type. If leakage occurs at the tube-tube plate connection in heat exchangers with a double tube plate

construction, there will be emission into the atmosphere instead of to the other medium. The double tube plate connection is fairly expensive.

Tube-tube plate connection

With a welded tube-tube plate connection there is a much smaller chance of leakage than with a rolled construction. Making a rolled connection into a welded connection can make existing heat exchangers better leak-proof. In this, there are two welds: a sealing weld (one layer of weld) or strength weld (usually two layers of weld). A cost indication shows that the price for a welded construction is about 9 to 11 Euro per tube higher than for a rolled construction.

Type of packing

With the flange seal of a floating head, the packing type can be changed. The usual types of packing, for instance an 'asbestos-free metal-wound' packing or a cam-profile packing, can be replaced by a seal with a weld ('Schweissdichtung').

ANNEX IV EXAMPLE OF SELECTION OF MATERIAL FOR COOLING WATER SYSTEMS IN INDUSTRIAL (NON-POWER PLANT) APPLICATIONS

[tm001, Bloemkolk, 1997]

IV.1 Introduction

The selection of construction materials in cooling systems, and especially the selection of materials for the coolers (heat exchangers), in many cases is a complex matter. It is the result being a balance between the requirements due to the chemistry of the water and the operational requirements (restricted additive use, number of cycles of concentration). To meet these requirements a large range of materials is offered. This Annex shows a few options for materials to be used in case of brackish water for open once-through systems.. It gives a qualitative selection of applications. In the individual case, the final selection will need to involve cost values to make a fair comparison taking into account also the consequences of a selection for the operational costs.

Choice of materials for heat exchangers

There are many factors that come together to determine the ultimate choice of materials for heat exchangers, such as:

- Composition and corrosiveness of the cooling water
- Manner of operation, e.g. through-flow or re-circulating cooling
- Corrosiveness and nature of the medium to be cooled
- Type of cooler
- Life-span
- Costs

These are some of the most important criteria that are taken into consideration in the design of a new cooler, on the basis of which ultimately a certain choice of materials is made. In many cases, this ultimate choice is the best possible compromise adhering to the principle that the cooler must have an economically acceptable 'life-span'. Within this life-span, however, many coolers will start leaking. An important cause of this is that, in practice, the cooler is not used in accordance with its design principles, whereas a change of process conditions for a variety of different reasons is quite common.

Important causes that can lead to leakage are:

- too high or too low speeds in the tube bank and poor circulation in the shell (Table IV.1);
- poor water treatment, i.e. applied method and control;
- too high metal temperatures on the cooling water side.

With regard to temperatures a metal temperature of 60°C is taken as an upper borderline as above this temperature the majority of corrosion inhibitors is less or not effective. Also in once-through systems formation of calcium salts occur.

Table IV.1: Cooling water velocity and type of material

Material	Velocity (m/s)
Aluminium brass	1.0 - 2.1
Copper nickel (90-10)	1.0 - 2.5
Copper nickel (70-30)	1.0 - 3.0
Carbon steel	1.0 - 1.8
Austenitic stainless steel (316)	2.0 - 4.5
Titanium	2.0 – 5.0

Choice of material for pumps

The choice of material for a pump is less critical because in many cases this equipment is doubled (has a back up). This means that if a pump breaks clown, the process is often not disturbed. Another factor is that the available walls are often much thicker than is strictly necessary (corrosion allowance).

Choice of materials for cooling water tubes

In most cases carbon steel with a sufficiently high corrosion allowance is chosen for the cooling water tubes. If a corrosion allowance of more than 3 mm is insufficient for an acceptable life span, alternative materials are chosen, such as plastics, carbon steel with an organic coating/concrete or, in exceptional cases, alloys of higher quality, such as stainless steel, monel and other nickel alloys, etc. Tubes have an advantage over machines in that they are much easier and cheaper to replace, which is why in the choice of materials is less critical.

IV.2 Direct once-through systems (with brackish water)

The composition and corrosiveness of "brackish water" is not fixed and can vary between "fresh" surface water and seawater. Brackish water is usually found in the transition area between rivers and/or other "freshwater" outflows and the sea (deltas). The composition and characteristics can vary widely by location and by season. Local water depth, the level of flow through (replacement) and the tides can play a role in the corrosiveness of this type of water. Some kinds of brackish water have a higher level of corrosiveness than seawater. For instance, in shallow water with an abundance of plant growth sulphur compounds can occur as a result of decomposition, which can cause serious pit corrosion in copper alloys. In a lot of cases the amount of suspended silt is considerable, which can heavily pollute the heat exchangers in the installation. In these cases, the use of stainless steel is dubious because the formation of pits (pitting) will almost certainly occur quickly. Because all of these factors are not well known in most cases, it is recommended that the corrosiveness of brackish water be considered equal to that of seawater with a relatively high level of suspended silt. Another advantage is that there is considerable knowledge and experience regarding the occurrence of corrosion by seawater.

Pumps

Depending on the situation, the materials in the table below are often used for pumps in brackish water (other materials are possible, but are usually much more expensive):

Table IV.2: Materials used for pumps in brackish water

Housing	Impeller	Drive-shaft	Comments
Nodular cast iron)*	Tin bronze	316)* Grey cast iron is also possible. Chance of gratification is significantly greater. Cast steel is also sometimes used.)* Austenitic stainless steel (Cr-Ni-Mo 18-8-2)
Aluminium bronze	Stainless steel 316)*	Monel	
Aluminium bronze	Aluminium bronze	Monel	
Tin bronze	Aluminium bronze	Monel	
Tin bronze	Stainless steel 316	Monel	

The tendency is to choose a combination for the housing and the fan, whereby the housing is, in principle, the anodic part of the construction.

Tubes

In most cases, carbon steel with a corrosion allowance is used. Another possibility is to provide the carbon steel with an organic coating, or to concrete it. In both cases the welds are the weak point of the construction.

Nowadays, glass-reinforced epoxy tubes are used increasingly, especially in underground systems. The great advantage of this material is that it is almost completely resistant to groundwater. The installation costs are about the same as those for a carbon steel tubing system that is coated, internally or externally, with an organic coating. Over time, this solution is often the cheaper of the two.

Heat exchangers/coolers

As earlier mentioned, the choice of material in a heat exchanger is somewhat more complex because, where the tube bank is concerned, the corrosiveness of the medium to be cooled must be taken into account. Assuming that the process medium is not corrosive for the material of the tube bank and that possible contamination (for instance, by copper ions) of the process is not significant, the choice of material is mainly determined by the quality of the water.

The possible choice of materials for 'shell & tube' heat exchangers in brackish water is given in the table below (water through the tubes).

Table IV.3: Materials used for shell&tube heat exchangers in brackish water

Shell/body	Water casing	Tubes	Tube-plate
Carbon steel	Carbon steel	Carbon steel) ^{*1}	Carbon steel
Carbon steel	Carbon steel) ^{*2}	Aluminium brass	Carbon steel
Carbon steel	Carbon steel) ^{*2}	Aluminium brass	Aluminium bronze
Carbon steel	Carbon steel) ^{*2}	Aluminium brass or and Cupro-nickel) ^{*4}	Carbon steel with a lining of aluminium brass
Carbon steel	Tin bronze	stainless steel 316) ^{*3}	Carbon steel
Carbon steel	Carbon steel) ^{*2}	Titanium) ^{*5}	Carbon steel

Comments Table IV.3:

There are various possibilities in the list above. The ultimate choice is largely determined by the level of corrosiveness of the brackish water and by the process conditions.

)^{*1} Tubes of carbon steel are only possible when one is certain that the water is not corrosive (e.g. through practical experience). This is almost never an option.

)^{*2} The water casings are usually given an organic coating plus a few sacrificial anodes. If the tube plate is made of a more precious metal, an organic coating must be applied to this metal to prevent galvanic effects in the water casing.

)^{*3} The use of austenitic material such as 316 is not without risks. In the event of pollution there is a good probability of pitting. This process can be extremely fast. Another risk is the possible occurrence of stress corrosion in this type of material. However, practical experience shows that this does not happen often, which is possibly due to the relatively low temperatures in this type of system. This risk can be significantly reduced or even prevented if one uses a higher version of alloy, such as 904L, 254SMO or Incoloy 825. These types of material are also used when the process side requires this.

)^{*4} Cupro-nickel alloys and others are chosen if the design metal temperature is too high for aluminium brass.

)^{*5} In many cases, titanium is the best choice. It is often assumed that a heat exchanger of titanium is too expensive. The price of this material has fallen dramatically in recent decades and it has been economically applied. Expectations are that decreasing cost differences and increasing problems with water treatment will lead to an increased use of Ti compared to that of Cu-Ni alloys now still applied.

In addition to its high resistance to corrosion, even in extremely polluted water, this material has various advantages:

- Extremely thin walled tubes can be used, so less material per m² heating surface area.
- The conductivity of heat is very good.
- The scrap value is high and the material well suited for reuse.
- It has a long life expectancy.

A disadvantage is that biological growth is stronger than is the case, for instance, with copper-containing alloys. It therefore requires extra use of biocides. Another thing is that titanium cannot be used in a reducing environment, because no protective oxide layer is formed.

IV.3 Indirect once-through system (brackish water/demin-water)

In the indirect (secondary) once-through system, the heat is absorbed in a closed secondary cooling circuit, after which the absorbed heat is transferred to an open once-through system via a heat exchanger. Characteristically, in these systems the water quality/corrosiveness is different for each cooling circuit. The primary part is usually of poorer quality than the secondary part. In this case, the primary part once again contains brackish water and the secondary part demin-water.

Material selection for primary circulation cooling system

The materials for the primary system, filled with brackish water, are described in Section IV.2. The heat exchanger between the primary and secondary system is extremely important for operation. Failure of this heat exchanger has serious consequences, so this should be taken into account when selecting the materials for it. If the primary cooling agent is brackish water, then the best choice for the tubes or plates (plate exchanger) is titanium. Other high-quality alloys such as 254 SMO or better can be considered in certain cases, but in most cases titanium is the best choice.

Selection of material for secondary circulation system

Essential for a closed secondary system is that making the water oxygen free prevents corrosion. In this case, demin water has been chosen as the cooling medium. However, in an aerated state, this demin water is extremely corrosive for carbon steel. This can be suppressed by alkalisating the water (pH=9). Clean tap water with a relatively high chlorine content is, in principle, just as good as demin water.

If these provisions are present, then the water is 'dead', which means its corrosiveness is minimal. In principle, all materials, including the tubes in heat exchangers, pumps and tubes fins, can be made from carbon steel. The conditions in the process must naturally be taken into account.

It is important that the concentration of oxygen in these systems is checked regularly. In some cases, nitrates are used as an inhibitor in these systems. By keeping the water alkaline and/or treating it with nitrates, leaking in of oxygen is less critical.

IV.4 Open recirculating cooling systems

IV.4.1 Fresh water application in open wet cooling tower

With respect to the application of material, one of the objectives in the design of an open recirculating cooling system (open wet cooling tower) is to condition the water in the system in such a way (inhibitors, pH control, etc.), that use of carbon steel for most parts of the system is economically acceptable.

This case is based on tap water. Depending on the composition and the cycles of concentration, the concentration of components in this water will increase (sometimes called 'thickening'), whereby the number of dissolved salts rises proportionally, which increases corrosiveness. With inhibitors and the right pH levels, this effect is suppressed. The design of such a system is usually based on the fact that the water is not corrosive for carbon steel.

Most parts, such as tubes and pumps, are therefore made of carbon steel. The tubes in a heat exchanger are also often made of carbon steel. In critical systems or to provide more security, the tubes are also often made of aluminium brass. Problems usually arise when the medium to be cooled is corrosive. In very many cases, austenitic steel or a better alloy must then be used, with the same risks as indicated above, for instance pitting or stress corrosion.

It is extremely important that pollution is kept to a minimum. This applies, in principle, to all cooling water systems. In an open circulation cooling system, 'side-stream' filtration is often used, or in critical coolers (condensers) a self-cleaning system (for instance with rubber balls) is installed.

IV.4.2 Salt water application in open wet cooling towers

[tm110, BDAG, 1995]

The use of salt or brackish water in cooling towers requires applications that particularly pay attention to corrosion of metal materials. A number of observations can be summarised. For salt water resistant structures good experience has been gained with hardwood species and pressure treated wood. However, the latter are done with CCA and cannot be regarded as an environmentally sound method. Sulphate resisting cement for concrete constructions and reinforcements for external and interior elements are well proven. Silicon, Aluminium Bronze and/or Stainless Steel can be applied, but coated galvanised only above water distribution level. Plastic coatings are recommended on Aluminium/Silicon bronze items.

Fill materials should be open low fouling with a high load capacity, where combinations of film (upper parts) and non-film (lower parts) have shown to be effective. Water velocity should be low enough to prevent corrosion, but sufficiently high to prevent settlement of heavy solids. These particular measures amongst others can reduce water treatment requirements in salt-water applications.

ANNEX V OVERVIEW OF CHEMICALS FOR THE CONDITIONING OF COOLING WATER SYSTEMS

In all water-cooled systems additives are applied to treat the cooling water with the aim to protect the cooling system and to avoid a reduction of heat exchange due to scaling, fouling and corrosion. A wide range of additives is applied against these cooling water problems. The Annex gives an overview of the different types of additives that are applied in the different wet cooling systems. In the final section, treatment of cooling water in a wet open cooling tower is explained to illustrate the complexity of cooling water conditioning and the elements that are in play.

V.1 Corrosion inhibitors

V.1.1 Corrosion

Corrosion can be defined as the destruction of a metal by chemical or electrochemical reaction with its environment. The result is a metal oxide or other salt having little structural ability, which causes damage to the material. In cooling systems, corrosion causes two basic problems. The first and most obvious is the failure of equipment with the resultant cost of replacement and plant downtime. The second is decreased plant efficiency due to loss of heat transfer, which is the result of heat exchanger fouling caused by the accumulation of corrosion products.

Corrosion is caused or favoured by the presence of oxygen, the salt content, formation of deposits, or an excessive low pH level.

Corrosion can also result from fouling by the growth of organism, so called microbiologically-influenced corrosion (MIC): acid producing bacteria cause corrosion and vibrating mussels cause erosion.

V.1.2 Applied corrosion inhibitors

Corrosion inhibitors can be identified by their function. They remove corrosive material, passivate, precipitate or adsorb it. Passivating (anodic) inhibitors form a protective oxide film on the metal surface. Precipitating (cathodic) inhibitors are simply chemicals, which form insoluble precipitates that can coat and protect the surface. Adsorption inhibitors have polar properties, which cause them to be adsorbed on the surface of the metal.

The use of corrosion inhibitors varies from system to system. In **once-through systems** polyphosphates and zinc are applied and there is limited use of silicates and molybdates. In some countries hardly any corrosion inhibitors are dosed in once-through systems except for yellow metal inhibitors (e.g. ferrosulphate) dosed in copper alloy heat exchangers or condensers.

In **open recirculating systems** normally a more comprehensive corrosion control programme is required. For many years chromate based programmes were used, but due to its toxicity the use has been reduced significantly and should not be used anymore as there are good alternatives.. Most current used corrosion programmes are based on phosphates, and zinc is added if water conditions require this. Often is chosen to operate the system under alkaline conditions (pH of 8-9), but biocide and dispersant treatments might have to be adjusted accordingly under these circumstances. Water is then inherently less corrosive. Disadvantage of alkaline operation is the increased potential to scaling. Alkaline conditions in combination with organic phosphonates are effective against corrosion and scaling.

Theoretically, **closed water systems** should not require corrosion inhibitors. Any oxygen introduced with the initial make-up water should soon be depleted by oxidation of system

metals, after which corrosion should no longer occur. However, closed systems usually lose enough water and leak enough air to require corrosion protection. Another theory is that the high residence time of the water, up to several months, is responsible for the heavy treatment with corrosion inhibitors. For closed systems the three most reliable corrosion inhibitors are chromate, molybdate, and nitrite materials. Generally, the chromate or molybdate have proven to be superior treatments. The toxicity of chromate restricts the use, particularly when a system must be drained. In many cases a non-chromate alternative is available, but in some member states their use is still permitted. Molybdate treatments provide effective corrosion protection and are seen as more environmental acceptable as chromate treatments.

Finally, it depends on the systems conditions (materials used and pH) what kind of corrosion inhibitors is best applicable. For instance the most effective corrosion inhibitors for copper are the aromatic azoles. Concentrations in evaporative recirculating cooling systems typically range from 2 to 20 mg/l as active compound. For some anodic inhibitors (such as chromates, molybdates and nitrites) concentrations used in the past are reported to be 500 to 1000 mg/l. in closed systems.

V.2 Scale inhibitors

V.2.1 Scaling

If concentration of salt in the water film within the heat exchanger exceeds its solubility, precipitation occurs, which is referred to as scaling. The main forms of scale are calcium carbonate and calcium phosphate, but also calcium sulphate, silicates, Zn and Mg deposition can occur depending on the minerals contained in the water. Scaling reduces the performance of the heat exchanger, since the thermal conductivity of calcium carbonate is about 25 times lower than that of steel. Scaling depends on three major factors: mineralisation (alkalinity), higher temperature and pH of the circulating water and of secondary factors: presence of complexing organic matters and chemical composition of the heat exchanger surfaces. Also, certain shape of the heat exchanger body favour scaling. Corrugations, oblique channels and an insufficient ratio of water flow per film surface area favour scaling. In recirculating systems high cycles of concentration can lead to scaling as well.

Scaling may cause problems in cooling towers, as the film fill can be very susceptible to various types of deposition. Because of evaporation (1.8% of the circulation per 10K of cooling) in the tower, minerals and organic substances in the recirculating water may concentrate to such a level that scaling can occur.

For power stations in particular, it was reported that scaling occurs due to:

- heating of the water up to 30°C in direct cooling and 45°C in tower assisted circuits,
- evaporation of water to affect cooling in passage through the cooling towers, which gives rise to concentration of the dissolved salt up to a factor of 1.6 or as high as the concentration factor determines, and
- the losses of free carbon dioxide during passage of water through the towers causing a rise in the pH which varies with the flow rate and the type of packing. With older timber statted packs the pH was 7.5-7.8, but with plastic film flow pack, this increases to 8.2-8.4 in small towers (250 MW_e) as well as in large towers (900 MW_e or larger).

V.2.2 Applied scale inhibition

Scale formation can play a role in once-through and open recirculating cooling systems. In closed recirculating systems it should not be a major issue. It can occur if spills require frequent additions of make-up water and depending on the factors mentioned above.

The increase of concentration of salts in cooling water in **open recirculating cooling systems** and distribution systems is caused by evaporation in the cooling tower and to be controlled by the blowdown. The ratio of particulate solute in the recirculating water to that in the make-up water is called *concentration factor*. The concentration factor ranges from as low as 2-3 for large power plants until 8-9 for some recirculating industrial cooling water systems. Typical concentration factors in industry (not power plants) range between 3 and 5.

In practice, scaling is controlled by adjustment of the pH value by dosing of acid and by the application of scale inhibitors. Experiences in large systems of power stations equipped with cooling towers show that treatment with acid (sulfuric acid or hydrochloric acid) does not lead to a change in pH, which remains alkaline. The acids rather neutralize the alkalinity to avoid the precipitation of CaCO_3 .

However, in decarbonated waters pH control can be done by addition of acids. Decarbonation by precipitation of calcium carbonates depends on three major factors, which are mineralisation (alkalinity), temperature, and pH of the circulating water. Secondary factors are presence of complexing organic matters in water and the chemical composition of the heat exchanger surfaces.

Three alternatives were reported for the chemical treatment of cooling water to avoid scaling in heat exchangers and wet cooling towers in large wet cooling systems :

- decarbonation of make-up water (resulting in a sludge to be disposed of)
- addition of acid
- addition of organic scale inhibitors

The most important scale control agents are polyphosphates, phosphonates, polyacrylates, copolymers and ter-polymers. Typical concentrations of scale control agents range from 2 to 20 mg/l, as active compound. Hardness stabilisers prevent the formation of crystals and are used in recirculating systems, but rarely or never in once-through systems.

Closed recirculating systems are not subject to scale formation in the primary system except when hard make-up water must be used. Many closed systems use zeolite-softened water or condensates as make-up water to prevent scale problems. Generally, some corrosion occurs due to loss of water or leakage of air. In the secondary cooling circuit water circulates in an open evaporative system. Here corrosion can occur on the outside of the coils where wet heat transfer takes place.

V.3 Fouling inhibitors (dispersants)

V.3.1 Fouling

Fouling occurs when insoluble organic particulates suspended in water of both **once-through** and **open recirculating cooling systems** form deposits on the systems' surface. Particulate matter, particle sizes and low water velocities are factors that enhance fouling. Foulants can be sand, silt, iron oxides and other corrosion products and they can react with some water treatment chemicals as well. They can either be airborne, can enter the cooling system with the water (silt, clay) or are introduced by process leaks and can be very finely dispersed with sizes as small as 1-100 nm.

Dispersants are polymers used to prevent fouling by removing particulate (organic) matter (e.g. microfouling and slime layer) from the heat exchanger surface by increasing the electric charge resulting from absorption. The particles repel each other and as a result remain suspended. To facilitate penetration of biocides into microfouling and slime layers surfactants often referred to as biodispersants can be used. Dispersants help to keep the surface of heat exchangers clean, thereby reducing the risk of corrosion. It is common practice to dose biocides in combination with dispersants at levels of 1-10 mg/l as active ingredient.

V.3.2 Applied fouling inhibitors

The most effective and widely used dispersants are low molecular weight anionic polymers. The most important dispersants are: organic and metal sulphonates, metal phenolate, metal dialkyl dithiophosphanates, sodium dialkyl sulphosuccinates, polyethylene alkyl and alicyclic amines, and monoethanolamine phosphate salts, polyacrylates, polymetacrylates and acrylate based polymers.

V.4 Biocides

V.4.1 Biofouling

Entrainment of organisms through water or air may lead to biofouling. Biofouling is generally of two main types: macrofouling (e.g. mussels) and microfouling (e.g. bacteria, fungi, algae).

Macrofouling is generally confined to **once-through systems** and is more severe in marine and brackish water than in fresh water. Macrofouling may cause gross blockage of pipework and culverts, and may cause so-called erosion corrosion. Macrofouling is very much location and water quality specific, both in terms of quantity and species variety.

Microfouling related problems occur both in **once-through and open recirculating cooling systems**. Microbial growth on wetted surfaces leads to the formation of biofilms. The result of uncontrolled microbial growth on surfaces is slime formation. The biological component or biofilm is produced by the living cells and their metabolic by-products. Microfouling is always the primary coloniser of surfaces in the development of biofouling.

The predominant effect of biofouling is reduction of heat transfer capacity of the heat exchangers and energy losses due to increased frictional resistance. Furthermore, where an exposed metal becomes fouled microbial induced corrosion can occur. In addition microbial species may threaten human health by spreading via cooling towers.

A number of antifouling techniques and treatments are available. These applications, the type of cooling water and the associated water problems are summarised in Table V.1.

Table V.1: Survey of fouling and clogging organisms, and degree of fouling in marine, brackish and fresh water. In the last column mitigation is presented (The degree of fouling is indicated as: + some; ++ fair; +++ heavy) (From: Applied Hydroecology 10, 1-2, 1998)

Country	Type of cooling water, associated fouling, clogging and scaling			Main antifouling mitigation techniques
	Marine	Brackish	Freshwater	
Belgium		Hydrozoa + Slime ++	Slime ++ Zebra mussels + Asiatic clam + Bryozoans ++ Gastropods ++ In cooling towers: scaling ++	Freshwater: Water filtration, debris filters. On-line condenser cleaning by sponge balls. Discontinuous Chlorination with hypochlorite
Denmark	Mussels + Slime +	See marine	Not used	Marine water: Water filtration, debris filters. On-line condenser cleaning by sponge balls. Non-toxic antifouling paints.
France	Mussels +++ Barnacles ++ Clogging by: Seagooseberries (jellyfish) +++ seaweeds +++	Fouling: no special problems due to wide variations in salinity in large estuaries. Clogging by driftings macrophytes +	Zebra mussels ++ Bryozoans ++ Algae ++ Gastropods ++ Asiatic clam + In cooling towers: scaling ++	Marine water: Water filtration, debris filters. On-line condenser cleaning by abrasive sponge balls (some units). Continuous chlorination at low dosage (0.5-1.0 mg/L), with electrochlorination Freshwater: Water filtration, debris filters. On-line condenser cleaning by sponge balls. Shock chlorination once or twice a year
Germany			Zebra mussels + Slime ++ In cooling towers: scaling ++	Freshwater: Water filtration, debris filters. On-line condenser cleaning by sponge balls. Discontinuous Chlorination with hypochlorite. H ₂ O ₂ , ozone
Ireland	Mussels + Slime + Clogging by: Fish +++	See marine	Zebra mussels	Marine water: Water filtration, debris filters. On-line condenser cleaning by balls. Continuous chlorination with hypochlorite

Table V.1 (cont.): Survey of fouling and clogging organisms, and degree of fouling in marine, brackish and fresh water. In the last column mitigation is presented (The degree of fouling is indicated as: + some; ++ fair; +++ heavy) (From: Applied Hydroecology 10, 1-2, 1998)

Country	Type of cooling water, associated fouling, clogging and scaling			Main antifouling mitigation techniques
	Marine	Brackish	Freshwater	
Italy	Mussels +++ Hydroids ++ Tubeworms ++ Barnacles ++ Slime ++ Clogging by: seaweeds + Posidonia +	(only one station) Clogging by: seaweeds + debris +	Zebra mussels Slime ++ Clogging by: drifting plants, leaves +	Marine water: Water filtration, debris filters. On-line condenser cleaning by abrasive sponge balls. Continuous or intermittent chlorination by hypochlorite or electrochlorination. Freshwater: Water filtration, debris filters. On-line condenser cleaning by sponge balls. Intermittent chlorination (very few cases)
The Netherlands	Mussels +++ Slime ++ Clogging by: jellyfish +++ fish ++	Mussels ++ Slime + Clogging by: fish +	Zebra Mussels + Slime ++ Clogging by fish ++	Marine & Freshwater: Water filtration, debris filters. On-line condenser cleaning by sponge balls. Heat treatment. Chlorination continuous or discontinuous, with hypochlorite
Norway			Hydro-power: only problems with migrating fish.	
Portugal	Mussels ++ Slime +		Asiatic clam +	Marine water: Water filtration, debris filters. On-line condenser cleaning by abrasive sponge balls (some units). Continuous chlorination at low dosage (0.5-1.0 mg/L), with electrochlorination Freshwater: Water filtration, debris filters. On-line condenser cleaning by sponge balls.
Spain	Slime + Tubeworms + Mussels ++ Oysters +		Slime ++ In cooling towers: scaling ++	Marine & Freshwater: Water filtration, debris filters. On-line condenser cleaning by sponge balls. Discontinuous chlorination, low and shock dosage, with hypochlorite and electrochlorination.
United Kingdom	Barnacles + Mussels ++ Slime ++ Clogging by: fish +++ Seaweeds ++ Jellyfish +	See marine	Slime ++ In cooling towers: scaling ++	Marine & Freshwater: Water filtration, debris filters. On-line condenser cleaning by sponge balls. Continuous chlorination (intermittent in winter) with hypochlorite and electrochlorination

V.4.2 Applied biocidal treatment

To combat biofouling in industrial open wet cooling systems, biocides are added to the cooling water. On biocides, their use and their effects, a lot of research has been done and a large number of publications can be found.

Biocides are substances that slow down the microbiological growth in the cooling water, reduce the total number of cells in the feedwater and weaken stability of the biofilm matrix, and thereby minimising organic pollution in the cooling system. Microbiological growth includes the development of micro-organisms, bacteria, algae and fungi, and also the developments of macro-organisms, such as oysters, barnacles and mussels.

Generally, biocides are defined as either oxidising biocides or non-oxidising biocides.

Oxidising biocides have a non-specific broad-spectrum biocidal mode of action, which limits the degree to which fouling organisms can develop resistance to these biocides. Non-oxidising biocides are more selective and more complex in their working and therefore need a longer reaction time than oxidising biocides.

The environmental problem of biocides, however, is their inherent toxicity. Some antimicrobials used in cooling systems are compounds that rapidly break down in water, thereby alleviating some potential environmental hazards. This chemical breakdown is often accompanied by a reduction in the toxicity of the compound. The compound can be added to the cooling water system, accomplish its task of killing the microbes in the system and then break down into less toxic chemicals.

The consumption of biocides is determined by the type of cooling system, the water resource (fresh or salt), the season and leakage of organic materials from the process and the systems half-time. In **once-through systems** almost solely biocides are used. Usually, these are oxidative biocides such as hypochlorite or derivatives as hypobromite.

In **open recirculating cooling systems** use of biocides is made on the basis of an oxidative biocide alone or in combination with a non-oxidative biocide. The consumption of non-oxidative biocides and other conditioning agents is almost completely determined by recirculating cooling water systems. Furthermore, it has been observed that in some closed recirculating systems no biocides are being added at all.

Table V.2 gives an indication of the amounts of biocides used in some European Member States.

V.4.3 Oxidising biocides

The oxidising biocides commonly used in industrial cooling systems are the halogens, chlorine and bromine, in liquid and gaseous form, organic halogen donors, chlorine dioxide and ozone, monochloramine and peroxides. In case of seawater conditions there is a growing interest in the application of chlorine dioxide, because of its effectiveness and the reduced formation of bromated hydrocarbons (in particular bromoforme, chlorodibromomethane, bromodichloromethane and dibromoacetonitrile) and trihalomethanes (THM) compared to hypochlorite, but on the other hand it produces ClO_3^- ions.

Chlorine gas (Cl_2) is also used in some places being compact and cheap, but has a safety risk when stored in bulk and gives some difficulties in handling.

Sodium hypochlorite is the most commonly oxidising biocide used in large once-through systems. It can be produced on marine sites by electrolysis of seawater. This process, called electrochlorination, avoids the transport and storage of dangerous chlorine gas or solution.

The consumption of sodium hypochlorite as active chlorine demand is generally lower in and around saltwater systems than on freshwater systems, because of a higher level of dissolved and particulate organic matter in fresh water. Due to its higher bromide content, the formation of

halogenated organics in seawater is reported to be lower than in freshwater (rivers), but no publications could confirm this.

Table V.2: Estimated consumption levels of some commonly used oxidising biocides in a few European Member States (kg/yr) (KEMA, 1996)

Group	Oxidising biocides	United Kingdom (1993) ²	Netherlands (1995) ³	France (1998)
Chlorine based	Sodium hypochlorite	731000 ^{1,5}	1800000 ⁴	817000 ⁶
	Sodium dichloroisocyanurate	19300		
	Chlorine dioxide	13000		
Bromine based	Sodium bromide	356000	22500	
	1-bromo-3-chloro-5,5-dimethylhydantoide (BCDMH)	286000	1000	
Other	Hydrogen peroxide	910		
	Peracetic acid	975		

Notes:
¹ estimated use as active ingredient, (as formulated product the amounts are much higher)
² in all cooling water systems
³ only in recirculating systems
⁴ measured as Cl₂
⁵ this figure is an underestimation as in the U.K much electrochlorination is employed in most coastal power stations
⁶ in Cl₂ produced by electrochlorination at fossil fuel power stations

This will also hold for cooling systems using water from heavily polluted harbours. Continuous ‘low’ chlorination is often preferred, although discontinuous or semi-continuous chlorination is more and more practised. However, this requires more intensive monitoring of the cooling system and the cooling water.

From both the chlorine gas and the sodium hypochlorite solution, the most active chemical species is the non-dissociated hypochlorous acid. This is a very reactive oxidising agent and reacts with most organics in the water to form the trihalomethane (THM) chloroform (3-5%) and other chlorinated organics. Free chlorine can also react with ammonia to produce chloramines or with diverse dissolved organic compounds forming different types of organohalogenated compounds (such as THM, chlorophenols). This occurs in the cooling system itself also and not before this first chlorine demand has been met, the residual chlorine will be able to do its biocidal work.

The use of the oxidising biocide hypobromous acid (HOBr) could be an alternative to hypochlorite. The hypobromous acid remains undissociated at higher pH values than is valid for hypochlorous acid. This implies that at pH 8 and above the free oxidant HOBr is a more efficient biocide than the dissociated hypochlorous ion OCl⁻. As a consequence, in alkaline freshwater, the effective dosage of hypobromite can be much lower than the equivalent hypochlorite. Although, brominated organics are 2-3 times more toxic than the chlorinated equivalents, they decompose more rapid and given the lower demand could provide a distinct environmental advantage. However, in marine water, the oxidation of bromide ions by hypochlorite leads to a rapid formation of hypobromite and the chlorination of sea water is almost equivalent to the bromination and there may be little environmental benefit in the hypobromous option compared with the hypochlorous option.

Bromide and sodium hypochlorite, chloramine and peroxyde are used in combination in recirculating systems, which is also expected to give less environmentally hazardous substances. A disadvantage of this treatment could be that at high concentrations of free oxidant (FO) solutions the formation of carcinogenous bromate could occur. Another possible source can be the ozonation of natural waters by the oxidation of bromide ions.

The bromate content depends on the bromide concentration in the brine water used to produce sodium hypochlorite. The theoretical maximum bromate concentration (BrO_3^-) in sodium hypochlorite solutions produced by electrolysis of seawater is around 100 mg/l or 3 mg per g of chlorine. A wide range of bromate concentration is found in commercial hypochlorite solutions. If concentrated brines are used for chlorine production it varies from 0.15 to 4.0 mg BrO_3^- per g of chlorine.

V.4.4 Non-oxidising biocides

Non-oxidising biocides are comparatively slow reacting substances that react with specific cell components or reaction pathways in the cell. The following non-oxidising biocides are reported to be commonly used: 2,2-dibromo-3-nitrilopropionamide (DBNPA), glutaric aldehyde, quaternary ammonium compounds (QAC), isothiazolones, halogenated bisphenols and thiocarbamates, but many others are in the market and within Europe the amount and the frequency of use of the individual biocide varies considerably. Table V.3 gives an indication of the consumption of some non-oxidizing biocides.

The application of non-oxidising biocides instead of oxidising biocides is recommended only in cases where oxidising biocides are not able to give sufficient protection, such as in systems with high organic loads, or in recirculating wet cooling systems where daily control is not a practice. In large recirculating wet cooling systems, where mostly sodium hypochlorite is used, sometimes constant monitoring is applied to ensure that the correct level of free oxidants is available in the circuit. For many smaller recirculating wet cooling systems however, and for those operated by water service companies who do not have personnel permanently on-site, application of non-oxidising biocides that are less influenced by the water quality are preferred over the oxidising biocides [tm005, Van Donk and Jenner, 1996].

Non-oxidising biocides are mainly applied in open evaporative recirculating cooling systems. Generally, they are applied to cooling water systems to give water active ingredient concentrations from about 0.5 ppm up to 50 ppm (exceptionally 100 ppm).

Non-oxidising biocides exert their effects on micro-organisms by reaction with specific cell components or reaction pathways in the cell. The first reaction involves damage to the cell membrane and in the other reaction damage is being done to the biochemical machinery in the energy production or energy utilisation of the cell.

Quaternary ammonium compounds are cationic surface-active molecules. They damage the cell membranes of bacteria, fungi and algae, thus increasing the permeability of the cell wall resulting in denaturation of proteins and finally death of the cell. Isothiazolones are non-specific and they interfere with ATP-syntheses in the cell. Of the others methylene(bis)thiocyanate (MBT) is widely used against bacteria and fungi and this biocide is believed to bind irreversibly to biomolecules preventing necessary reduction and oxidation reactions. Glutaraldehyde is used against both aerobic and anaerobic bacteria and its biocidal activity is based on protein cross-linking.

Table V.3: Estimated consumption levels in some of European Member States of some commonly used non-oxidising biocides in kg/yr (KEMA, 1996)

Group	Non-oxidising biocides	United Kingdom (1993) ²	Netherlands (1995) ³	France (1998)
QAC	Dimethyl cocobenzyl Ammonium chloride	23400 ¹		
	Bezyl-alkonium ammonium compounds	21400		
	Total QAC estimate	71152		
Isothiazolines	5-chloro-2-methyl-4-isothiazolin-3-one	13200		
	Total isothiazolines	18000	1500	
Others	Halogenated bisphenols (dichlorophen+fentichlor)	12150		
	Thiocarbamates	56800		
	Glutaraldehyde	56400	750	
	Tetraalkyl phosphonium chloride	9500		
	2,2-dibromo-3-nitrilo-propionamide	17200	800	
	Methylene(bis)thio-cyanate (MBT)	2270	1450	
	β -bromo- β -nitrostyrene (BNS)	231	1950	
	Fatty amines			20000 ⁴
	Others	4412		
	Estimated total	234963	6450	

Notes:
¹ estimated use as active ingredient (as formulated product the amounts are much higher)
² in all cooling water systems
³ only in recirculating systems
⁴ active product used at a marine fossil fuel power station

V.4.5 Factors determining the use of biocides.

[tm005, Van Donk and Jenner, 1996]

The following factors focus on the use of biocides, but could be applied to the use of other additives as well.

- Effectiveness

Obvious as this may sound, a biocide has to be effective in the specific situation it is used in. However, it is important to realise that a biocide - or a cooling water treatment program - that is effective in one system, may not be so in another system, even if these systems are apparently identical. One of the reasons for this can be the development of a resistant or tolerant population of micro-organisms. For oxidising biocides this is less of a risk than for non-oxidising biocides.

- System type

The system type determines the hydraulic half-time of the cooling water in the wet cooling systems, and thus the contact time between the biocide and the cooling water. In once-through wet cooling systems, where residence times are short, fast reacting - oxidising - biocides are generally used. At present if biocides are being used in once-through systems in the Netherlands sodium hypochlorite is applied. Slower reacting non-oxidising biocides are at present only used

in recirculating wet cooling systems. The majority (> 90%) of the recirculating cooling water systems is being treated with NaOCl, Cl₂, ClO₂ or NaOCl./NaBr.

The type of process is an important factor in the choice of a biocide, especially when considering the reactivity of some biocides with process fluids spilled into the cooling water. Some processes, like the direct cooling of metal in the metal industry create special conditions in the cooling water. Process fluids leaking into the cooling water may function as a nutrient for biological growth.

- Water quality

Chemical and biological water quality affects the choice of a cooling water treatment programme, and thus the choice of a biocide. Occurrence of macrofouling organisms is very much water quality related. Generally speaking, an increased quality of the surface water in biological terms may result in an increased occurrence of macrofouling in wet cooling systems.

For micro-organisms, water type does not play a major role in defining the types of organisms encountered. In theory a pH value of approximately 7 is optimal for microbial growth. Acid conditions will favour growth of fungi and pH values higher than 8 will reduce algae growth. However, in practice micro-organisms prove to be highly adaptable and can colonise a variety of systems. An illustration of this is the commonly held belief that fungi prefer acidic to neutral media for growth, and will be supplanted by bacteria in an alkaline system. This is fundamentally correct, but if such a system is treated with a bactericide with no antifungal activity, often contamination with fungal spores allows colonisation of the system, even at a pH value of 9.

In once-through systems, the pH value inside the cooling system is equal to that of the entrained water, although dosing of sodium hypochlorite may slightly increase the pH value but this is usually impossible to measure. In open evaporative recirculating systems the pH value is often controlled, ranging generally from 7 to 9, by addition of acids (often sulphuric acid) or a base (often sodium hydroxide) or cycling natural alkalinity.

For the application of sodium hypochlorite and sodium hypobromite as a biocide, it is well known that the pH value strongly influences the equilibrium between hypochlorous acid and the hypochlorite ion. Hypochlorous acids are approximately hundred times more toxic than their anionic form. Therefore, in theory, the pH value will affect the toxicity of for example hypochlorite dose.

In practice, the pH value cannot be influenced in **once-through systems**. Freshwater once-through systems typically use cooling water at pH 7 - 8; seawater cooled systems operate at a pH value of approximately pH 8. The above-mentioned equilibrium is therefore most relevant for the effectiveness of the treatment in once-through systems, since residence time of the cooling water - and thus contact time of the biocide with the organisms - in the cooling system is relatively short.

Wet recirculating systems generally are operated at a pH value ranging from 7 - 9. Experience in the chemical industry has shown that a recirculating system operating at pH value of 9 uses less hypochlorite than a system operating at a lower pH value, without loss of effectiveness of the treatment. The fate of hypochlorite in recirculating systems has been extensively studied. The main conclusion from this is that 5-10% of the hypochlorite dosed is lost in the tower when operating at pH value of 8.5, while at a pH value of lower than 7 this is 30 - 40%.

The explanation for this is that the hypochlorite anion cannot be stripped out of the cooling tower. This is in contrast with hypochlorous acid. It is concluded that hypochlorite dosage at a pH value of 9 is equally effective, in spite of the fact that only (1 - 5%) is present in the acid form, because the hypochlorous acid consumed will be instantly replenished from the surplus present in the anionic form. The overall conclusion therefore is that operating recirculating systems at a high pH value will reduce the amount of hypochlorite needed for effective microfouling control.

The temperature of the surface influences the growth of the marine biology and can therefore be used as a factor for the choice of a treatment programme in **once-through cooling systems**. Macrofouling in once-through systems in the Netherlands will not grow rapidly during winter months. Therefore it is not necessary to dose biocides when water temperatures are lower than 12°C. Industries with once-through systems on the Mediterranean coast, where severe macrofouling growth and spat fall take place all year round, dose oxidising biocides all year round. In general, water temperature will greatly affect species variability, growth rate and biocide demand. In once-through systems the water temperature added to the bulk water (ΔT) is 8 - 12 °C, restricted by a maximum discharge temperature. Recirculating systems face the same restriction at the point of discharge, although sometimes higher discharge temperatures are allowed. Temperatures in the recirculating bulk water can be 20 - 30 °C and higher. Most macrofouling species in the Netherlands do not tolerate long-term exposure to temperatures of 30 °C, but some species, such as the brackish water mussel, grow very rapidly at these temperatures.

For **recirculating systems** with high concentration factors, the hardness of the intake water and the amount of organic materials are of extreme importance, since this will affect the amount of scaling and corrosion inhibitors needed. Both for once-through and recirculating systems the amounts of organic material (dissolved solids, suspended solids) in the cooling water are important, since they influence biocide demand. The extent into which this influences biocides varies (e.g. hypochlorite will react with ammonia, chlorine dioxide will not). In general it is advisable to reduce to a minimum all substances that lead to increased biocide demand.

V.4.6 Interactions with other water treatment chemicals

Other additives such as corrosion and scale inhibitors can also affect the choice of a suitable biocide. Some biocides limit each other's effectiveness, but can also be of reciprocal benefit. For example:

- QACs are known to be partially neutralised by oxidative biocides and anionic dispersing agents;
- Isothiazolones on the other hand are stabilised by sodium hypochlorite;
- Ozone is such a strong oxidant that it will oxidise almost any other cooling water additive, which is specifically a problem for corrosion inhibitors that often have to be applied to some extent adjacent to the ozone application to protect the equipment.

V.5 Cycles of concentration and water balance

The application of additives in open evaporative cooling towers is complex and largely related to the water balance and the cycles of concentration with which the system is operated. The blowdown is an important measure to correct the solids balance and plays a role in the optimisation of cooling systems performance and cooling water treatment. A short explanation of the principle of blowdown is given below Figure V.1.

A quantity of cooling water (Q_c) is circulating through the system in m³ per minute. Passing the heat exchanger the cooling water is cooled down in the cooling tower by evaporation and convection. Evaporation (E), drift, windage and some leakage reduce the amount of cooling water and consequently the concentration of salts in the water increases which could lead to scaling and corrosion.

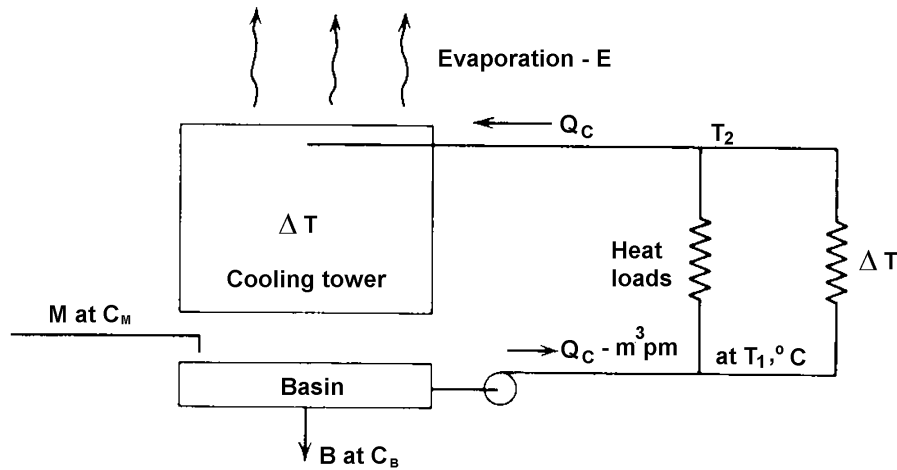

Figure V.1: Tower and solids balances for an evaporative cooling system using a cooling tower [tm135, Anonymous, 1988]

This is balanced by bleeding the system, which process is called blowdown (B with concentration C_b) and compensated by adding water called make-up (M with concentration C_m). As the system has to be balanced use is made of the concentration ratio (CR): $CR = M/B = C_b/C_m$ (because $M \times C_m = B \times C_b$).

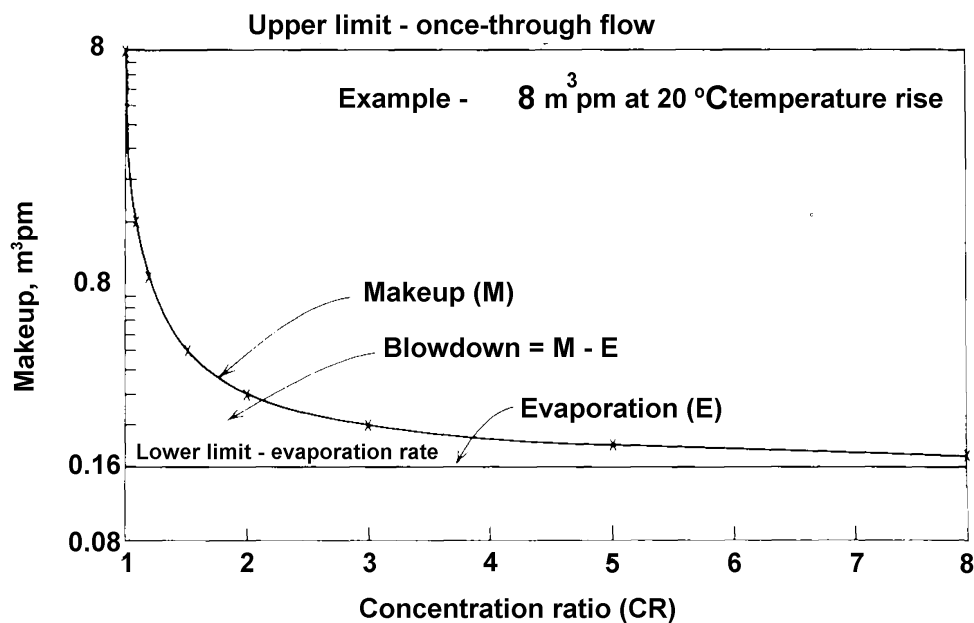

Figure V.2: Reduction of the make-up flow by concentration in an evaporative cooling system [tm135, Nalco, 1988]

$M = E+B$, thus $CR = (E+B)/B = E/B+1$ and from this equation follows that

$$\mathbf{B = E/(CR-1)}$$

This is a very useful equation in cooling water treatment. After the cycles of concentration have been determined based upon the make-up and blowdown concentrations, the actual blowdown being lost from the system, or the blowdown required to maintain the system at the desired number of cycles, can be calculated.

ANNEX VI EXAMPLE OF LEGISLATION IN EUROPEAN MEMBER STATES

The following text has been integrally included to give an example of legislation that has been successfully applied in Europe to reduce the emissions of cooling systems.

General Administrative Regulation of 31 January 1994

On the Amendment to the

General Administrative Framework Regulation on

Minimum Requirements for the Discharge of Waste Water into Waters

(currently, august 2000, being revised)

Excerpt of

Appendix 31: Water Treatment, Cooling Systems, Steam Generation

1 Scope

- 1.1 Waste water in which the contaminant load originates primarily from the treatment of water from cooling systems of industrial processes.

2 Requirements

The following requirements for the discharge of waste water must be complied with. The requirements for chemical oxygen demand, for nitrogen as the sum of ammonium, nitrite and nitrate nitrogen, for inorganic phosphorus compounds and for filterable substances are based on generally recognised technical rules, the remaining requirements on best available technology.

These requirements shall not apply to waste water discharges of less than 0.5 m³ per day.

2.1 General requirements

The waste water must not contain - with the exception of phosphonates and polycarboxylates - any organic complexing agents which are not readily biodegradable in accordance with the basic level requirements of the Chemicals Act for determining ready biodegradability by means of the OECD Guidelines 301 A - 301 E of May 1981.

The waste water must not contain chromium compounds or mercury compounds, nitrite, organometallic compounds (metal-carbon bonds) or mercaptobenzothiazole originating from the use of operating and ancillary resources.

The requirements in the first and second paragraphs shall be deemed to be complied with if the substances specified are not used, all operating and ancillary resources used are listed in an operating journal and manufacturers' information is available showing that such substances are neither present in the operating and ancillary resources used nor capable of forming under operating conditions.

2.3 Requirements for waste water from cooling systems

2.3.1 Water from single-pass or open-ended fresh water cooling systems

The requirements after shock treatment with microbicial substances shall be as follows:

	Qualified random sample or 2-hour composite sample (mg/l)
Chlorine dioxide, chlorine and bromine (expressed as chlorine)	0.2
Adsorbable organic halogens (AOX)	0.15

Microbicial substances other than hydrogen peroxide and ozone must not be present in the waste water. These requirements shall be deemed to be complied with if such substances are not used, all operating and ancillary resources used are listed in an operating journal and manufacturers' information is available showing that such substances are not present in the operating and ancillary resources used.

2.3.2 Water from flushing of primary cooling circuits in power stations (flushing water from recirculation cooling systems)

	Random sample (mg/l)
Chemical oxygen demand (COD)	30
Phosphorus compounds as phosphorus, total ²⁾	1.5
<i>If only inorganic phosphorus compounds are used, the value for the parameter phosphorus is increased to 3 mg/l.</i>	

The requirements after shock treatment with microbicial substances shall be as follows:

	Random sample (mg/l)
Adsorbable organic halogens (AOX)	0.15
Chlorine dioxide, chlorine and bromine (expressed as chlorine)	0.3
Toxicity to luminescent bacteria T _B	12

The luminescent bacteria toxicity requirement shall also be deemed to be complied with if the flushing circuit is kept closed until a T_B value of 12 or less is reached in accordance with manufacturers' information about input concentrations and biodegradation behaviour and this is substantiated by an operating journal.

Zinc compounds from cooling water conditioning agents must not be present in the waste water. This requirement shall be deemed to be met if all operating and ancillary resources are listed in an operating journal and manufacturers' information is available showing that the cooling water conditioning agents used do not contained any zinc compounds.

2.3.3 Waste water from flushing of other cooling circuits

	Random sample (mg/l)
Chemical oxygen demand (COD) <i>The value for the parameter COD is increased to 80 mg/l after cleaning with dispersants.</i>	40
Phosphorus compounds as phosphorus, total ²⁾ <i>The value for the parameter phosphorus is increased to 4 mg/l if only zinc-free cooling water conditioning agents are used. It is increased to 5 mg/l if the zinc-free conditioning agents used contain only inorganic phosphorus compounds.</i>	3
Zinc	4
Adsorbable organic halogens (AOX)	0.15

The requirements after shock treatment with microbicidal substances shall be as follows:

	Random sample (g/l)
Chlorine dioxide, chlorine and bromine (expressed as chlorine)	0.3
Adsorbable organic halogens (AOX)	0.5
Toxicity to luminescent bacteria T_B	12

The luminescent bacteria toxicity requirement shall also be deemed to be complied with if the flushing circuit is kept closed until a T_B value of 12 or less is reached in accordance with manufacturers' information about input concentrations and biodegradation behaviour and this is substantiated by an operating journal.

- 2.5 In the case of holding ponds, all values shall be for the random sample. Here the values relate to the quality of the water before emptying.
- 2.6 Compliance with the requirements in item 2.3 for the parameter COD may also be checked by determining total organic carbon (TOC). In this case, the COD value is to be replaced by three times the TOC value as determined in milligrams per litre.

2) Determination in the original sample in accordance with DIN 38406 - E22 (March 1988 edition) or an equivalent measurement and analysis procedure.

ANNEX VII EXAMPLE OF A SAFETY CONCEPT FOR OPEN WET COOLING SYSTEMS (VCI-CONCEPT)

VII.1 Introduction to the concept

This safety concept has been elaborated in order to provide assistance with regard to the protection of waters from the temporary discharge, via cooling water, of (process) substances causing long-term detrimental changes to water bodies. The concept specifies measures of monitoring and changeover in connection with once-through cooling systems and alternatives to once-through cooling systems as a function of the persistence of water pollution by substances, which can be discharged into the cooling water.

The capacity of a substance to cause long-term detrimental changes or to pose a hazard to a water body can be determined on the basis of the R - phrases established under European legislation on hazardous substances. A certain score is allocated, as shown in the table below, to each of the R - phrases relating to the protected assets aquatic-environment as well as human health and soil. The scores of all R - phrases assigned to the substance concerned are added up to obtain the total score. This total score is then linked with the required safety measure concerning the contaminated cooling water. Decisions relating to the implementation of such measures and the technology applied can, of course, only be taken within the individual companies concerned and with knowledge of the particular circumstances.

It will be recommended to apply this concept immediately to new plants and to refit existing cooling-systems if they do not meet these requirements within:

- 5 years for substances with total score ≥ 9

- 8 years for substances with total score from 0 - 8

For substances with total score ≥ 5 measures with regard to the monitoring of once-through cooling systems should be tackled immediately taking into account the requirements of individual cases.

The requirements of this safety concept refer to all cooling water streams, which are not connected to industrial purification plants or to an appropriate water-associated purification plant. The requirements concerning substances with total score ≤ 4 do not refer to indirect discharges which are fed to a sewage treatment plant.

Table VII.1: Score for a number of R-phrases to calculate the total score for process substances

Score	1	2	3	4	5	6	7	8	9
Ecotoxicity and Degradation/bio-accumulation				52/53		51/53		50/53	
Ecotoxicity and/or Degradation/bio-accumulation n.y.d.				* 3)		* 2)		* 1)	
Ecotoxicity			52			50			
Ecotoxicity n.y.d.						*			
Degradation/bio-accumulation			53						
Degradation and/or bio-accumulation n.y.d.			*						
Acute mammalia toxicity (acute orale toxicity preferred)	22 20/22 21/22 20/21/22 21 20/21 65		25 23/25 24/25 23/24/25 24 23/24			28 26/28 27/28 26/27/28 27 26/27			
Acute mammalia toxicity n.y.d.					*				
Carcinogenicity and/or mutagenicity		40							45 and/or 46
Irreversible effect		40/21 40/22 40/20/22 40/21/22 40/20/21/22		39 39/24 39/25 39/23/25 39/24/25 39/23/24/25		39/27 39/28 39/26/28 39/27/28 39/26/27/28			
Recurrent Exposure		33 48 48/21 48/22 48/20/22 48/21/22 48/20/21/22		48/24 48/25 48/23/25 48/24/25 48/23/24/25					
Reproduction toxicity		62 and/or 63		60 and/or 61					
Dangerous reaction with water			29 15/29						

Legend to the table on the previous page:

n. y.d. = attributes not yet determined (tested or known)
 * = score, if one or more of the attributes, "ecotoxicity", "degradation/bioaccumulation" and "acute toxicity" were not tested or not known

Footnote 1) - Ecotoxicity and degradation and/or bioaccumulation n.y.d. or ecotoxicity n.y.d. and easy degradation not proved or
 - ecotoxicity n.y.d. and potential of bioaccumulation available or classified into R 50 and degradation and/or bioaccumulation n.y.d.

Footnote 2) - Ecotoxicity > 1 and ≤ 10 mg/l and degradation and /or bioaccumulation n.y.d.

Footnote 3) - Ecotoxicity > 10 and ≤ 100 mg/l and degradation n.y.d.

Footnote 4) - See Appendix 2 for description of R-phrases

VII.2 Requirements of the concept

The requirements put on the cooling technology is determined by the respectively highest total of points of those process substances that can enter the cooling water. These requirements are summarized in the following table.

Table VII.2: Requirements of VCI safety concept for cooling technology

score: 0 points	score: 1 - 4 points	score: 5 - 8 points	score: ≥ 9 points
(D1 + A1)	(D1 + A1 + U1)	(D1 + A2 + U1) (D2 + A1 + U1)	(D3 + A2 + U1) / (D2 + A2 + U2) / (Z) (E) / (K) / (L) / (S)
... alternative options			

D1, A1 and U1 are always replaceable by the higher measures D2 (or D3), A2 and U2.

The codes in the table are described as follows:

- D1 Once-through cooling system;
- D2 once-through cooling system with a cooling water pressure which is kept clearly and in a controlled way above the process pressure (cooling water pressure should not fall below process pressure at any point in the cooling system, also not by hydraulic processes);
- D3 Once-through cooling system with cooler made of high-quality anticorrosive material and regular maintenance;
- Z Intermediate storage with analytical control prior to discharge;
- E Cooling via primary/secondary circuits (decoupling);
- K Circulation cooling via recooling systems;
- L Air cooling system;
- S Special cooling system (e.g. heat pumps, absorption cold plants, vapour compression systems, heat transformers);

- A1 Analytical or other adequate monitoring of cooling water;
- A2 Automatic analytical monitoring of cooling water (according to the appendix);

- U1 Immediate changeover of the cooling water discharge to holding facilities or a purification plant provided that such a plant is appropriate for the disposal of the released substance or immediate changeover to reserve cooling system or switch-off of the part of the production plant concerned;

- U2 Automatic changeover of the cooling water discharge to holding facilities or a purification plant provided that such a plant is appropriate for the disposal of the released substance or automatic changeover to reserve cooling system or switch-off of the part of the production plant concerned.

VII.3 Appendix 1 - Automatic analytical monitoring of once-through cooling systems

Automatic analytical systems are appropriate for the monitoring of once-through cooling systems if leakage can be determined with sufficient safety and sufficiently rapid. In this connection it is sufficient that the analytical system provides trend data. The measurement of absolute concentrations is not necessary for such systems, but merely the detection of deviations from normal states.

Measurement can either occur directly by sensors in the cooling water stream or via automatic sampling semi-continuously outside the cooling water stream.

For the following parameters and analytical methods, equipment is on the market which is appropriate for automatic monitoring of once-through cooling systems in the above sense. With regard to the selection of equipment for this function, the reliability of the system is generally more important than increased demands on its accuracy.

The selection of the appropriate system is determined by the substance(s) released in connection with a leakage and it is, moreover, strongly dependent on the special circumstances of individual cases. In this connection it should first be checked whether the automatic analytical monitoring can be carried out by means of a parameter or of an analytical method of the following List 1. If this proves not to be possible, the use of systems in accordance with List 2 should be checked.

List 1: - ph-value
- conductivity
- redox potential
- turbidity
- refractometry.
- photometry
- oil warning equipment
- foam warning equipment
- mercury monitors

List 2: - TC (total carbon),
- TOC (total organic carbon),
- DOC (dissolved organic carbon),
- purgable substances by means of FID (flame ionization detector),
- TOC/FID combination,
- purgable chloro-organic compounds,
- bacterial toximeters.

VII.4 Appendix 2 – R-phrases used to calculate VCI-score

Table VII.3: Description of R-phrases used to calculate VCI-score for cooling systems selection

R 20/21	Harmful by inhalation and in contact with skin.
R 20/21/22	Harmful by inhalation, in contact with skin and if swallowed.
R 20/22	Harmful by inhalation and if swallowed.
R 21	Harmful in contact with skin.
R 21/22	Harmful in contact with skin and if swallowed.
R 22	Harmful if swallowed.
R 23/24	Toxic by inhalation and in contact with skin.
R 23/24/25	Toxic by inhalation, in contact with skin and if swallowed.
R 23/25	Toxic by inhalation and if swallowed.
R 24	Toxic in contact with skin.
R 24/25	Toxic in contact with skin and if swallowed.
R 25	Toxic if swallowed.
R 26/27	Very toxic by inhalation and in contact with skin.
R 26/27/28	Very toxic by inhalation, in contact with skin and if swallowed.
R 26/28	Very toxic by inhalation and if swallowed.
R 27	Very toxic in contact with skin.
R 27/28	Very toxic in contact with skin and if swallowed.
R 28	Very toxic if swallowed.
R 29	Contact with water liberates toxic gas.
R 33	Danger of cumulative effects.
R 39	Danger of very serious irreversible effects.
R 39/24	Danger of very serious irreversible effects in contact with skin
R 39/25	Danger of very serious irreversible effects if swallowed
R 39/23/25	Danger of very serious irreversible effects through inhalation and if swallowed
R 39/24/25	Danger of very serious irreversible effects in contact with skin and if swallowed.
R 39/23/24/25	Danger of very serious irreversible effects through inhalation, in contact with skin and if swallowed
R 39/27	Danger of very serious irreversible effects in contact with skin
R 39/28	Danger of very serious irreversible effects if swallowed
R 39/26/28	Danger of very serious irreversible effects through inhalation and if swallowed
R 39/27/28	Danger of very serious irreversible effects in contact with skin and if swallowed
R 39/26/27/28	Danger of very serious irreversible effects through inhalation, in contact with skin and if swallowed
R 40	Possible risks of irreversible effects.
R 40/21	Harmful: possible risk of irreversible effects in contact with skin.
R 40/22	Harmful: possible risk of irreversible effects if swallowed.
R 40/20/22	Harmful: possible risk of irreversible effects through inhalation and if swallowed.

Table VII.3 continued	
R 40/21/22	Harmful possible risk of irreversible effects in contact with skin and if swallowed.
R 40/20/21/22	Harmful possible risk of irreversible effects through inhalation, in contact with skin and if swallowed.
R 44	Risk of explosion if heated under confinement.
R 45	May cause cancer.
R 48	Danger of serious damage to health by prolonged exposure.
R 48/21	Harmful: danger of serious damage to health by prolonged exposure in contact with skin.
R 48/22	Harmful: danger of serious damage to health by prolonged exposure if swallowed.
R 48/20/22	Harmful: danger of serious damage to health by prolonged exposure through inhalation and if swallowed
R 48/21/22	Harmful: danger of serious damage to health by prolonged exposure in contact with skin and if swallowed.
R 48/20/21/22	Harmful: danger of serious damage to health by prolonged exposure through inhalation, in contact with skin and if swallowed.
R 48/24	Toxic: danger of serious damage to health by prolonged exposure in contact with skin.
R 48/25	Toxic: danger of serious damage to health by prolonged exposure if swallowed.
R 48/23/25	Toxic: danger of serious damage to health by prolonged exposure through inhalation and if swallowed.
R 48/24/25	Toxic: danger of serious damage to health by prolonged exposure in contact with skin and if swallowed.
R 48/23/24/25	Toxic: danger of serious damage to health by prolonged exposure through inhalation, in contact with skin and if swallowed.
R 50	Very toxic to aquatic organisms.
R 51	Toxic to aquatic organisms.
R 52	Harmful to aquatic organisms.
R 53	May cause long-term adverse effects in the aquatic-environment.
R 60	May impair fertility.
R 61	May cause harm to the unborn child.
R 62	Possible risk of impaired fertility.
R 63	Possible risk of harm to the unborn child.
R 65	Harmful: may cause lung damage if swallowed.
R 15/29	Contact with water liberates toxic, highly flammable gas.

ANNEX VIII EXAMPLES FOR THE ASSESSMENT OF COOLING WATER CHEMICALS

VIII.1 Benchmark assessment concept for cooling water chemicals

VIII.1.1 Introduction

General

It is well established that the cooling BREF is “horizontal” in nature, and that it is not possible to identify a “BAT cooling system” as such because so much is dependent on the specific process being cooled, and its location (especially climate, water supply etc.).

Therefore, the approach to be taken in the BREF must be one of providing “tools” to help the Member State authorities rationalise what options are available, and select an optimal cooling solution (both in terms of equipment, and “operating conditions”) which will represent BAT for IPPC permitting purposes.

Firstly, in terms of “plant equipment”, such selections will mainly be made when new systems are built, but also in the context of upgrades or retrofitting of existing systems.

Secondly, the “operating conditions” which are applied in both existing and new systems have been singled out for attention in discussions. A key element of these “conditions” relates to the optimisation of the cooling system in terms of efficiency and plant longevity through the use of chemicals. BAT-based optimisation decisions will need to be made in terms of what chemicals are used, and in what quantities, for permitting purposes.

An approach has been developed within the TWG for a simple so-called “benchmarking” method to help the Member States compare different chemicals one with another on the basis of potential environmental impact. Without such a tool, the complexity of making such decisions could be a serious obstacle in determining what is BAT for cooling systems in a rational way at the local level.

As is described below, most of the main elements for establishing such a risk-based benchmarking tool can already be found in Community legislation and its official supporting documentation. The present approach seeks to draw together elements from: the IPPC Directive, the Water Framework Directive, and Risk Assessment legislation and the supporting “Technical Guidance Document” in a coherent manner, to provide a tool to help evaluate cooling chemicals.

VIII.1.1.1 Background

From its earliest meetings, the TWG agreed by consensus that any assessment of cooling water chemicals should involve both intrinsic properties and local situation characteristics (*risk based approach*).

The ensuing Benchmarking Assessment Concept arises as a result of consideration of existing assessment schemes and methodologies, and seeks to provide a starting point for proper consideration of both intrinsic properties and the local level situation in the assessment of different possible treatment regimes.

The assessment concept does not enter into a discussion of the Intrinsic Hazard Approach, but concentrates on the task of explaining and clarifying the Benchmarking (relative ranking) Procedure.

It essentially focuses on individual substances, giving brief indications of how the method could be extended to multi-substance complete chemical treatments.

Also, only the most complex case (and most frequent) of open recirculating systems (cooling systems with an evaporative cooling tower) is dealt with, with the possibility of later extension to once-through, closed systems, etc.

VIII.1.1.2 Relevant legislative background

There is no need, here, to evoke in any detail the legislative requirements which have led to the development of BAT reference documents. It is enough to mention Article 16.2 of the IPPC Directive on exchange of information, and the initiative of the Commission to develop, through the institution of the Information Exchange Forum, a tool which should assist and guide Member States Authorities to set Emission Limit Values (ELV) for IPPC Listed Plants.

It is of importance, though, to underline one of the key aspects of the Directive: the control of emissions and their impact on the environment through a “combined” method of BAT set emission limit values to be checked against environmental quality standards.

Also very relevant in this context is the shortly to be adopted Water Framework Directive (WFD).

Although it might be the case that a correct evaluation of the effects of chemical treatments used in cooling systems should be subject to a multimedia assessment, it is also correct to state that the major concerns associated to the use of these chemicals regard the main potential receiver of polluting substances: the aquatic-environment.

A few words are therefore necessary to briefly review the relevant parts of the WFD.

VIII.1.1.3 The water framework directive (WFD)

While the WFD goes much further than providing elements to prevent and control emissions from Industrial IPPC Plants, it does in fact supply one key link with the IPPC Directive. It fixes methods and procedures for the Commission to prioritize dangerous substances and to propose, for these, emission controls and EQSs (Environmental Quality Standards; or “Quality Standards”), to be adopted by the Council and the European Parliament.

Furthermore it gives to the Member States the right and the duty to fix Quality Standards for any other substances that are relevant, in any River Basin, to the achievement of the objectives set by the Directive itself.

More important than this, it introduces in an annex (Annex V Section 1.2.6) a simple procedure to be used by the Member States Authorities to calculate Environmental Quality Standards (EQSs) for chemical substances in water.

In other words, it provides one of the conditions required by the IPPC Directive to implement a combined approach: methods and procedures to calculate Quality Standards.

According to the Water Framework Directive (WFD) text (Annex V Section 1.2.6), Member States are to determine EQSs in the following way:

Test Method	Safety Factor
At least one acute L(E)C ₅₀ from each of three trophic levels of the base-set	1000
One chronic NOEC (either fish or daphnia or a representative organism from saline waters)	100
Two chronic NOECs from species representing two trophic levels (fish and/or daphnia or a representative organism from saline waters and/or algae)	50
Chronic NOECs from at least three species (normally fish, daphnia or a representative organism for saline waters & algae) representing three trophic levels	10
Other cases, including field data or model ecosystems, which allow more precise safety factors to be calculated and applied.	Case by case assessment

While a more detailed analysis of the significance and implications of this table will be made later, there are a few notes that need to be made at this point:

- a) The Quality Standards set on this basis only take into account the protection of the aquatic system, without considering the indirect-human effects
- b) The numbers resulting from the above table are Predicted No Effect Concentrations (PNEC) (See Technical Guidance Document for Regulation 793/93/EEC)
- c) The Commission has developed a Prioritization Procedure, which is based on a system in which an aquatic effect score is combined with a bio-accumulation score and a human effect score. The procedure has been used to provide the basis for the Commission's proposed "priority list" of substances to be controlled at EU level by means of emissions controls and EQSs to be adopted under the Water Framework Directive.

The following benchmarking assessment concept is also based on the above method of Calculating Quality Standards. This is for the following reasons:

- in the context of the BREF, the method must be clear, simple straight forward, transparent and easy to use
 - it is most probable, even if a lot of work is needed to prove this, that the aquatic-environment is the weakest link of the chain
 - the benchmarking methods will be used in combination with EU chemicals legislation (Intrinsic Hazards), which, implicitly includes evaluation of potential indirect adverse effects (both on the aquatic-environment and on humans) through the inclusion of bio-accumulation, the CMT properties (carcinogenic, mutagenic, teratogenic) as well as chronic effects in the classification of hazardous chemicals.
- The WFD also requires that Member States set EQS for waters intended for Drinking Water Abstraction: this will be another check point to take into account human health in one of the most important exposure routes.

VIII.1.2 Benchmarking : introduction of the concept

The Benchmarking Assessment Concept is founded on carrying out substance by substance comparisons using a standardised theoretical measure of the Predicted Environmental Concentration (here in referred to as PEC_{standardised}). This PEC_{standardised} is compared with the corresponding Predicted No Effect Concentration (PNEC) or EQS of the substance, determined in accordance with the method contained in Annex V of the Water Framework Directive. In this

way a ration can be calculated for each substance which permits a preliminary ranking of substances based on potential impact.

While the terms PNEC and PEC have now entered in the legislative language in the context of emissions law, and their significance will become common knowledge, it is worth at this point clarifying the concepts as they apply to the Benchmarking Procedure.

VIII.1.2.1 The PNEC

The Benchmarking Procedure does not attempt to rank the chemicals mentioned in the BREF itself.

The real-life situation is complicated by the fact that only rarely do chemical treatments for cooling systems consist of a single substance. The attempt to rank treatments in a BREF would imply the application of an “additive” procedure of some sort to an enormous list of possible substances combinations in the treatments. Assuming these combinations can be made available, this would require a large quantity of work and time, and would almost certainly fail to be either exhaustive or up to date.

Therefore, this Assessment Concept aims to offer a standard methodology, rather than a numerical assessment of substances or treatments.

The Member State (MS) Authorities may then use this methodology as they see fit, at MS level, or better still at local level.

At any rate, aquatic toxicity data must be available and be made available by chemical suppliers to permit evaluations of PNECs. This is a fundamental aspect of any ranking procedure.

It is worth noting, also, that the Annex V procedure, and the related table, have not been invented recently by the Commission in the context of the WFD. In fact the approach and the table have been strictly derived from the Technical Guidance Document on the assessment of Risk for Existing and New Chemicals.

(An extract of this pertinent portion is attached in VII.1.6 Appendix I).

Only a few words of clarification seem appropriate here.

The fewer data there are available the higher the assessment factor to be applied to convert toxicity data to PNECs.

The availability of chronic data reduces the factor. Progressing through a set of intermediate situations, having chronic data on three trophic levels allows the use of a factor of 10, compared to a factor of a 1000 when only acute toxicity data are available. The costs associated with performing chronic tests are much higher than the costs for acute testing. Thus it is likely that more acute than chronic toxicity data will be available.

When the Benchmarking Procedure is applied locally, the available data will have to be used together with the corresponding assessment factor.

It will be left, in this case, to the supplier of chemicals to decide whether or not to invest additional resources in obtaining chronic data, as and when this might prove necessary. For example, for a given plant it could be the case that using only acute data (which implies obtaining an EQS by dividing the LC50 by a “safety factor” of 1000 to take account of uncertainty) there may be difficulty in complying with the stringent resultant EQS. In this case the supplier might opt to obtain the more “certain”, but equally more time-consuming and more costly, chronic data. Chronic data implies dividing test result concentrations by a safety factor of only 10, which will lead to a more “certain” EQS, which may also be more achievable.

VIII.1.2.2 The PEC

The “real” PEC, in the context of chemicals used in a cooling system, must be seen and defined as the final concentration of the chemical in the river water, after discharge and after dilution with the river water at appropriate distance from the discharge.

When a chemical is used in a cooling system it is subject to a set of physico-chemical conditions which will determine its fate. As examples can be mentioned:
breakdown in the cooling system due to hydrolysis or photolysis,
adsorption by the system,
partitioning between water and air,
ending up in the sludge,
biodegradation in the cooling system itself, in the waste treatment plants (chemical/biological),
and in the river.

The portion that is not “lost” will end up in the river and will be diluted by the river flow. A precise appraisal of the final River PEC, is only possible at local level.

Models and algorithms to achieve this task are available, but they must take into account the very specific conditions of each site. Obviously, also, the final PEC will depend on the amount of chemical that is fed, and this in turn depends on the size of the system and on the operating conditions (Number of cycles of concentration, size of the plant and amount of heat to be removed).

Most of the following analysis will center on describing a simple method to calculate a “standard” PEC ($PEC_{\text{standardised}}$) which, while not bearing any resemblance with real PEC values, permits a rapid, preliminary evaluation of chemicals relative to one another. It is stressed that $PEC_{\text{standardised}}$ has only a very restricted, limited value, and can only be used as a general starting point for the evaluation of the potential effects of chemicals relative to one another.

VIII.1.3 Basic cooling towers material balances

A very simple sketch of a Cooling Tower System is reported in Figure VIII.1 below.

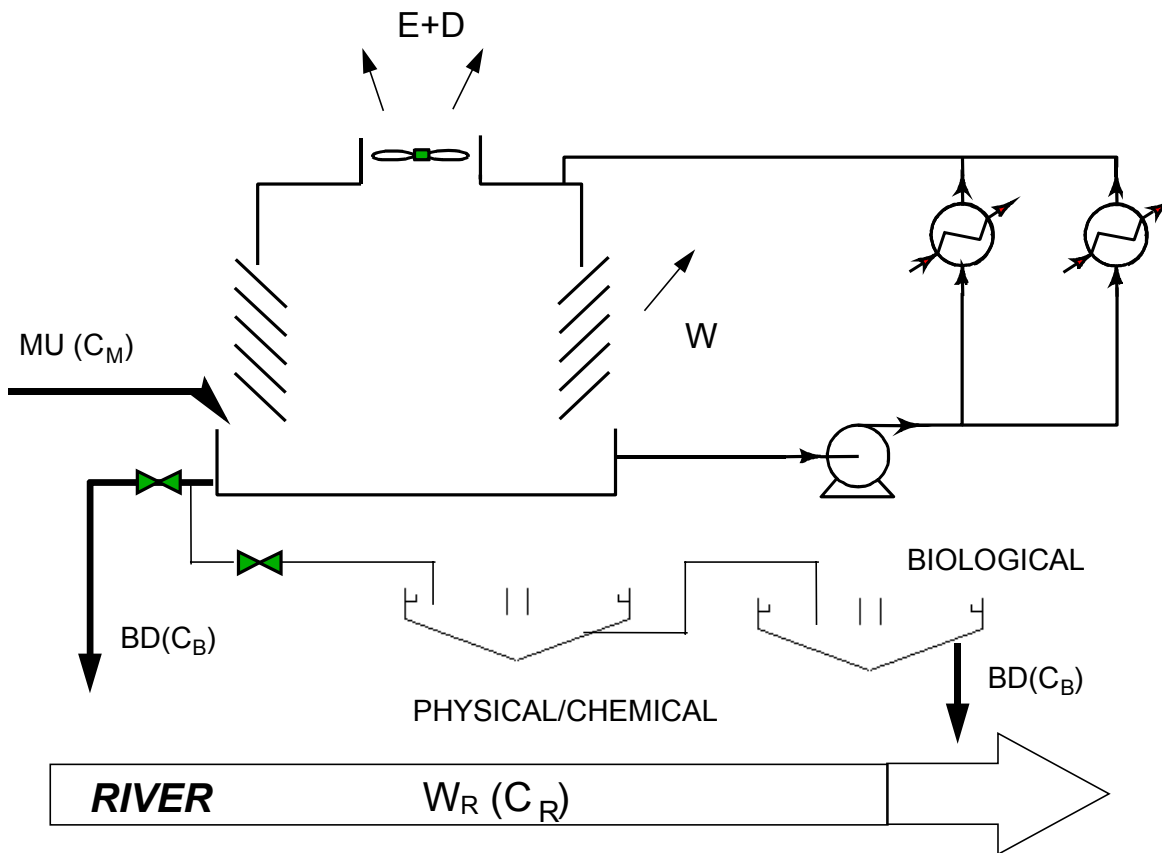

Figure VIII.1: Cooling tower material balance

VIII.1.3.1 Cooling towers basic equations

MU	: Make-Up Rate	mc/hr
BD	: Blow-Down Rate	mc/hr
W	: "Windage" (includes drift losses – "D")	mc/hr
E	: Evaporation Rate	mc/hr
C_M	: Concentration of Substance in MU	mg/l - gr/mc
C_B	: Concentration of Substance in BD	mg/l - gr/mc
N_C	: Cycles of Concentration = C_B/C_M	

VIII.1.3.2 Water balance

$$MU = BD + E + W$$

VIII.1.3.3 Material balance

$$MU \times C_M = (BD + W) \times C_B$$

VIII.1.3.4 Concentration

$$N_c = C_B/C_M = MU/BD + W$$

VIII.1.3.5 Discussion

Water enters the cooling system through the make-up line. Water must be “made-up” to compensate for the losses due to evaporation, “windage” and through the blow-down. The “windage” represents the quantity of water, which in the form of droplets escapes the cooling tower. It is assumed that the droplets carry with them the entrained chemicals at the same concentration as in the blow-down.

As water recirculates through the plant’s equipment, it takes heat with it, which in turn is taken out in the cooling tower through evaporation. No chemicals are carried-over with the water vapour (evaporated water).

The Evaporation Rate “ E”, results from design requirements. To compensate for the evaporation, windage (and blow-down losses - see below) it is necessary to continue to feed an equivalent amount of make-up water.

Make-up water, be it well water, or surface water, carries with it dissolved and suspended solids, and the concentration and type of which will vary from case to case. A portion of the recirculating water must, hence, be “blown-down” (discharged) to avoid the concentration of input substances to increase above tolerable values due to evaporation.

The value of the blow-down rate must be fixed in order to maintain an optimum concentration of substances in the recirculating water, which will avoid, together with the appropriate chemical treatment, fouling (through precipitation and deposition of solids) and corrosion.

The blow-down rate is fixed when designing the chemical treatment and operating conditions. Frequently in practice, and in older systems, the blow-down cannot be controlled. It results, at least partially, from unplanned water losses from various parts of the equipment being cooled.

The Number of Cycles of Concentration is the ratio between the concentration of substances in the blow-down and that in the make up water. For instance if the concentration of the Calcium ion in the make up is 200 ppm, with a Number of Cycles of 2, the concentration of Calcium in the recirculating water will be equal to 400 ppm.

The material balance above, shows that the Number of Cycles of Concentration is equal to the ratio $MU/(BD + W)$, and when ignoring the windage, to the ratio MU/BD .

Chemicals are fed to the cooling system either (rarely) in the make-up line, or into the cooling tower basin. A certain concentration of chemicals must be “maintained” in the recirculating water, which is equivalent to saying, maintained in the blow-down water. The higher the Number of Cycles the lower the blow-down, the more severe the conditions of the system, but the lower the quantity of chemicals continually lost.

This latest statement is true with the exception that when make-up substances are allowed to concentrate more and more in the tower, more and different chemicals may be necessary to maintain appropriate deposition-corrosion balance in the system.

In principle, though, in order to save water and chemicals (consumption, costs, and impact on the environment) a fine balance must be sought at the highest possible Number of Cycles of Concentration.

A certain concentration of treatment chemicals must be “maintained” in the recirculating water, and, hence, in the blow-down in order for the chemicals to perform their function.

Normally, in complex multi-substance treatments, it is prescribed that the level of one easily measurable substance, is controlled and maintained at the values advised by the chemicals suppliers. This corresponds to the implicit assumption that the ratio among the different chemicals stays the same, regardless of different rates of “losses” of the individual chemicals in the system.

It also corresponds to the important assumption that, if the concentration of chemicals is measured (one chemical measured, the others calculated) in the blow-down, this value corresponds to what is available in the cooling system, and that any other losses in the latter have already been taken into account.

In other words, to evaluate the impact of the chemical(s) on the aquatic-environment, only the fate, or the variations in the concentration of the chemical downstream of the blow-down line point, needs to be predicted (i.e. previously mentioned as “system” losses and the reductions in concentration, due to processes such as hydrolysis, adsorption etc -are already taken into account).

This assumption will be used in the Benchmarking Assessment Concept.

VIII.1.4 Calculation of PEC and benchmarking

Table VIII.1 below summarises the simple approach suggested for Benchmarking of single substances.

The suggested approach starts with the concept of calculating the “real” PEC_{river} , and to divide it by the correspondent EQS, as derived from the WFD.

Table VIII.1 below, shows how the “real” PEC can be calculated, and how, through successive approximations, it is possible to normalise/standardise the PEC estimation, and so render the calculation applicable for “benchmarking” purposes. If the BD rate, the River flow, and the losses of chemicals are known, the Concentration of the substance in the river results from the very simple equation (1) reported in the table.

Table VIII.1: Calculation of PEC and Benchmarking

PEC_{river}/EQS (EQS from Water Framework)C_B = Concentration in Blow-Down gr/mcC_R = Concentration in River gr/mc = PEC_{river}

BD = Blow-Down Rate in mc/hr

W_R = River Flow in mc/hr

t = (1 - % losses in Tower)

w = (1 - % losses in Waste Water Treatment Plant - WTP)

r = (1 - % losses in River)

$$(1) \quad C_R = \frac{BD \times C_B \times (t) \times (w) \times (r)}{W_R} \quad \text{Local Assessment/Predict}$$

t = 1

w = 1

r = 1

BD = 1

If also W_R = 1 we have C_B = C_R = proportional to PEC river

Equation (1), with all its elements known or calculated, can be used as such only for local level assessments.

To evaluate the losses in the cooling system, in the waste treatment plant, and in the river itself, a lot of specific data needs to be available regarding chemical and physicochemical data of each substance. This ranges from volatility, to biodegradability and deposition rate and concerns the specific conditions of the system, such as residence time of chemicals in the tower (proportional to the ratio Volume of System/Blow-Down rate), type and performance of waste treatment plants (chemical and biological), residence time in the river after initial mixing, and others.

In a “desk-top” benchmarking approach these data are not available. Hence the need for simplification and approximation.

- First of all it is assumed (see Table VIII.1) that the losses in the cooling system are taken already into account by referring to the concentration of the chemical in the blow down.
Secondly it is assumed that no losses take place in the waste treatment plant.
- This second assumption is clearly not correct in the “real world” - it puts all chemicals on the same level, whether or not they may be lost through precipitation in a chemical treatment plant, or through partial or complete bio-degradation in a biological treatment plant. Consideration may be given to introducing a correction factor for chemicals with different degrees of biodegradability; but it would also introduce a differentiation between different treatment situations, which will vary from case to case and site to site.
- Thirdly, it is assumed that no losses occur in the river, and this is normally done in risk assessment evaluations.

The key to the proposed Benchmarking approach lies in the next assumptions, that is that the Blow-Down Rate is equal to 1, and so is the river flow.

This means the PEC value has been normalised (i.e. PEC_{standardised}), to allow the comparison among chemicals, independent of Blow-Down rate (size of plant and operating conditions), and of River Flow.

It is obvious that for the same chemical the PEC will be higher in a larger plant with a higher blow-down rate, and when the plant discharges into a small river.

But this is unimportant when a set of chemicals needs to be compared (i.e. “benchmarked”). What will count for Benchmarking purposes is the feed rate of the chemical, or in other words,

the concentration which is recommended to be “maintained” in the recirculating system, and hence in the blow down. Normally chemical suppliers recommend a range of concentrations, varying from case to case: the average recommended feed rate should be used.

VIII.1.5 Computation methods

VIII.1.5.1 Single Substances

One-substance chemical treatments very rarely apply. In most cases various combinations of chemicals, inorganic and organic are used in cooling systems.

Examples of single substances are mostly related to the use of single biocides in the system, or single polymers in Waste Treatment Plants. Still, there is quite likely to remain a desire, possibly at Member State level rather than at local level, to Benchmark the most typical individual substances that are on the Market.

At local level it is easier to imagine that the necessity will arise to compare complete treatments, one against the other, rather than individual substances. A balanced vision of the overall impact of the various substances on the aquatic-environment can only be acquired at local level, when different proposed treatments have to be compared.

At any rate, the Benchmarking Procedure proposed here, does imply very simple computations for individual substances. The average prescribed concentration of the substance in the blow down is one of the terms that need to be known. It is generally expressed in parts per million (ppm) or milligrams per litre (mg/l) in the blow-down, and above we refer to this number as $PEC_{\text{standardised}}$.

The other element of the Equation is the PNEC or EQS. This may either have been already fixed by the Member State, or it will have to be “agreed” at local level using the WFD Annex V procedure, based on data furnished by the supplier of chemicals. EQSs are also normally expressed in ppm, and sometimes in ppb or micrograms per liter.

The PEC/PNEC ratio can hence be easily calculated for all the substances, which need to be assessed. The resulting value is a purely numerical ratio (if both PNEC and EQS are expressed in the same units, ppm, or ppb). The lower the ratio, the less the *potential* impact of the substance.

It is stressed once more that this Benchmarking Assessment Concept represents a standardised methodology for assessing potential impacts of cooling water chemicals, which strips out all local-specific characteristics, and all physico-chemical characteristics of substances except for toxicity. As such, it can perform a useful function in helping identify areas that require additional investigation, and in designing chemical treatments into the overall operating-design procedures of the plant. However, it is not suitable nor intended for use as a decision tool for local level assessments: the fact that one substance may have a lower $PEC_{\text{standardised}} : EQS$ ratio does not imply that this is necessarily the best choice for a particular situation once other local, plant and substance-specific factors are taken into account.

VIII.1.5.2 Complex multi-substances treatments

This will in practice most often be the case faced by local authorities and plant operators in permit applications.

Before carrying out, with the assistance of the supplier, a complete substance by substance real life PEC evaluation, which may be necessary in certain cases, the simplified benchmarking approach may be used to help design chemical treatments into the overall operating-design procedures of the plant.

Consideration may be given to using an additive procedure whereby the PEC/PNEC ratios for each individual substance is calculated with the method explained above, and they are then added together to yield a relative “index” number. This approach is similar to that used for the classification of chemical preparations based on the classification of the individual substances of which they are composed. The lower the value of the resulting sum the less is the foreseeable environmental impact of the complex treatment.

Needless to say, a sum of all the values of individual ratios, leading to a figure of less than 1 would be preferable to a result above 1. This would have meaning only when the real local dilution factor is known and inserted in the evaluation.

However, when values above 1 are found, and it is felt that, from a technical stand point the specific treatment presents other environmental/economic advantages (less water, less energy) it will be necessary to go into a more sophisticated risk assessment procedure. This may imply both a precise calculation of all the losses of the chemical in the system (fate) and a refinement of the evaluation of the PNEC (Chronic Data instead of Acute).

It would not seem that actually carrying out centrally in the BREF, or even at Member State level, a general benchmarking exercise including all possible treatments and combinations is a realistic idea. Multi-substance Benchmarking (i.e. of treatments) is more appropriately to be considered a local affair and reference is made to Section VII.2 of this Annex.

VIII.1.6 Appendix I: extract from technical guidance document

Chapter 3 (Environmental Risk Assessment), section 3.3.1 of Part II of “Technical guidance document in support of Commission Directive 93/67/EEC on risk assessment for new notified substances and Commission Regulation (EC) no 1488/94 on risk assessment for existing substances”.

3.3 Effects assessment for the aquatic compartment

3.3.1 Calculation of PNEC

The function of risk assessment is the overall protection of the environment. Certain assumptions are made concerning the aquatic-environment, which allow, however uncertain, an extrapolation to be made from single-species short-term toxicity data to ecosystem effects. It is assumed that:

- ecosystem sensitivity depends on the most sensitive species; and
- protecting of ecosystem structure protects community function.

These two assumptions have important consequences. By establishing which species is the most sensitive to the toxic effects of a chemical in the laboratory, extrapolation can subsequently be based on the data from that species. Furthermore, the functioning of any ecosystem in which that species exists is protected provided the structure is not sufficiently distorted as to cause an imbalance. It is generally accepted that protection of the most sensitive species should protect structure, and hence function.

For all new substances the pool of data from which to predict ecosystem effects is very limited: only short-term data are available at the base-set. For most existing substances the situation is the same: in many cases, only short-term toxicity data are available. In these circumstances, it is recognised that, while not having a strong scientific validity, empirically derived assessment factors must be used. Assessment factors have also been proposed by the EPA and OECD (OECD, 1992d). In applying such factors, the intention is to predict a concentration below which an unacceptable effect will most likely not occur. It is not intended to be a level below which the chemical is considered to be safe. However, again, it is likely that an unacceptable effect will occur.

In establishing the size of these assessment factors, a number of uncertainties must be addressed to be able to extrapolate from single-species laboratory data to a multi-species ecosystem. These areas have been adequately discussed in other papers, and may best be summarised under the following headings:

- Intra- and inter-laboratory variation of toxicity data
- Intra- and inter-species variations (biological variance)
- Short-term to long-term toxicity extrapolation
- Laboratory data to field impact extrapolation
(Extrapolation is required from mono-species tests to ecosystem. Additive, synergistic and antagonistic effects arising from the presence of other substances may also play a role).

The size of the assessment factor depends on the confidence with which a $PNEC_{\text{water}}$ can be derived from the available data. This confidence increases, if data are available on the toxicity to organisms at a number of trophic levels, taxonomic groups and with lifestyles representing various feeding strategies. Thus, lower assessment factors can be used with larger and more relevant data sets than the base-set data. The proposed assessment factors are presented in Table VII.1.

For new substances and assessment factor of 1000 will be applied on the lowest L(E)C₅₀ of the base-set. Also for existing substances the assessment factor is generally applied to the lowest of the relevant available toxicity data, irrespective of whether the species tested is a standard organism (see notes to Table 14). For short-term tests, the L(E)C₅₀ is used, while the NOEC is used with long-term tests. For some compounds, a large number of validated short-term L(E)C₅₀ values may be available. Therefore, it is proposed to calculate the arithmetic mean if more than one L(E)C₅₀ value is available for the same species. Prior to calculating the arithmetic mean an analysis of test conditions has to be done in order to find out why differences in response were found.

The algal growth inhibition test of the base-set is, in principle, a multi-generation test. However, for the purposes of applying the appropriate assessment factors, the EC₅₀ is treated as a short-term toxicity value. The NOEC from this test may be used as an additional NOEC when other long-term data are available. In general, an algal NOEC should not be used unsupported by long-term NOECs of species of other trophic levels. However, if a chemical shows a specific toxicity to algae, the algal NOEC determined from the base-set test should be supported by a second algae species test.

Microorganisms representing a further trophic level may only be used if non-adapted pure cultures were tested. The investigations with bacteria (e.g., growth tests) are regarded as short-term tests. Additionally, blue-green algae should be counted among the primary producers to their autotrophic nutrition.

Table VIII.2: Assessment factors to derive a PNEC

Description	Assessment factor
At least one short-term L(E)C ₅₀ from each of three trophic levels of the base-set (fish, Daphnia and algae)	1000 ^(a)
One long-term NOEC (either fish or Daphnia)	100 ^(b)
Two long-term NOECs from species representing two trophic levels (fish and/or Daphnia and/or algae)	50 ^(c)
Long-term NOECs from at least three species (normally fish, Daphnia and algae) representing three trophic levels	10 ^(d)
Field data or model ecosystems	Reviewed on a case by case basis ^(e)

NOTES :

- (a) The use of a factor of 1000 on short-term toxicity data is a conservative and protective factor and is designed to ensure that substances with the potential to cause adverse effects are identified in the effects assessment. It assumes that each of the above-identified uncertainties makes a significant contribution to the overall uncertainty. For any given substance there may be evidence that this is not so, or that one particular component of the uncertainty is more important than any other. In these circumstances it may be necessary to vary this factor. This variation may lead to a raised or lowered assessment factor depending on the evidence available. Except for substances with intermittent release (see Section 3.3.2) under no circumstances should a factor lower than 100 be used in deriving a PNEC_{water} from short-term toxicity data. Evidence for varying the assessment factor could include one or more of the following aspects:
- evidence from structurally similar compounds (Evidence from a closely related compound may demonstrate that a higher or lower factor may be appropriate).
 - knowledge of the mode of action. (Some substances, by virtue of their structure, may be known to act in a non-specific manner. A lower factor may therefore be considered. Equally a known specific mode of action may lead to a raised factor).

- the availability of data from a wide selection of species covering additional taxonomic groups other than those represented by the base-set species.
- the availability of data from a variety of species covering the taxonomic groups of base-set species across at least three trophic levels.
In such a case the assessment factors may only be lowered if these multiple data points are available for the most sensitive taxonomic group.

There are cases where the base-set is not complete: e.g., for substances, which are produced at < 1 t/a (notifications according to Annex VII B of Directive 92/32/EEC). At the most the acute toxicity for *Daphnia* is determined. In these exceptional cases, the PNEC should be calculated with a factor of 1000. Variation from a factor of 1000 should not be regarded as normal and should be fully supported by accompanying evidence.

- (b) An assessment factor of 100 applies to a single long-term NOEC (fish or *Daphnia*) if this NOEC was generated for the trophic level showing the lowest L(E)C₅₀ in the short-term tests. If the only available long-term NOEC is from a species (standard or non-standard organism) which does not have the lowest L(E)C₅₀ from the short-term tests, it cannot be regarded as protective of other more sensitive species using the assessment factors available. Thus, the effects assessment is based on the short-term data with an assessment factor of 1000. However, the resulting PNEC based on short-term data may not be higher than the PNEC based on the long-term NOEC available.

An assessment factor of 100 applies also to the lowest of two long-term NOECs covering two trophic levels when such NOECs have not been generated from that showing the lowest L(E)C₅₀ of the short-term tests.

- (c) An assessment factor of 50 applies to the lowest of two NOECs covering two trophic levels when such NOECs have been generated covering that level showing the lowest L(E)C₅₀ in the short-term tests. It also applies to the lowest of three NOECs covering three trophic levels when such NOECs have not been generated from that level showing the lowest L(E)C₅₀ in the short-term tests.
- (d) An assessment factor of 10 will normally only be applied when long-term toxicity NOECs are available from at least three species across three trophic levels (e.g., fish, *Daphnia*, and algae or a non-standard organism instead of a standard organism).

When examining the results of long-term toxicity studies, the PNEC_{water} should be calculated from the lowest available no observed effect concentration (NOEC). Extrapolation to the ecosystem effects can be made with much greater confidence, and thus a reduction of the assessment factor to 10 is possible. This is only sufficient, however, if the species tested can be considered to represent one of the more sensitive groups. This would normally only be possible to determine if data were available on at least three species across three trophic levels. It may sometimes be possible to determine with high probability that the most sensitive species has been examined, i.e., that a further long-term NOEC from a different taxonomic group would not be lower than the data already available. In those circumstances a factor of 10 applied to the lowest NOEC from only two species would also be appropriate. This is particularly important if the substance does not have a potential to bioaccumulate. If it is not possible to make this judgment, then an assessment factor of 50 should be applied to take into account any interspecies variation in sensitivity. A factor of 10 cannot be decreased on the basis of laboratory studies.

- (e) The assessment factor to be used on mesocosm studies or (semi-)field data will need to be reviewed on a case by case basis.

For compounds with a high log Kow no short-term toxicity may be found. Also, even in long-term tests this may be the case or steady state may still not have been reached. For tests with fish for non-polar narcotics the latter can be substantiated by the use of long-term QSARs (see Section 3.2.1.2 and Chapter 4 on the Use of QSARs). It can be considered to use a higher assessment factor in such cases where steady state seems not to have been reached.

For substances for which no toxicity is observed in short-term tests a long-term test has to be carried out if the log Kow > 3 (or BCF > 100) and if the $PEC_{\text{local/regional}}$ is > 1/100th of the water solubility (see Section 4.5). The long-term toxicity test should normally be a Daphnia test to avoid unnecessary vertebrate testing. The NOEC from this test can then be used with an assessment factor of 100. If in addition to the required long-term test a NOEC is determined from an algae test of the base-set an assessment factor of 50 is applied.

The effects assessment performed with assessment factors can be supported by a statistical extrapolation method if the data basis is sufficient for its application (see Appendix V).

VIII.2 Concept of a local assessment method for cooling water treatment chemicals, with a particular emphasis on biocides

VIII.2.1 Introduction

One of the major environmental issues identified in the industrial cooling systems BREF concerning wet cooling systems is the chemical treatment of cooling water (anti-corrosion; anti-scaling, anti-fouling, biofouling control), and the resulting emissions to surface water. Particular emphasis is placed on biocides, due to their inherent high toxicity, which is necessary as a result of the particular function they must perform.

The cooling BREF identifies three levels at which techniques may be employed to reduce the impact of cooling water additives/ biocides on receiving water bodies:

1. Preventive measures (Table 4.7)
2. Optimisation of operation, including monitoring (Table 4.8)
3. Selection & application of additives (Table 4.8)

The three levels of control interact with each other, and discussions in the TWG have established that the selection of appropriate additives is a complex exercise, which must take into account a number of local and site-specific factors.

The need to provide an outline of the concepts underlying assessment of cooling water additives/biocides has been identified as an important BAT measure to help reduce the environmental impact of additives, and biocides in particular. In this connection, the BREF contains an Annex which establishes a screening assessment tool based on existing methodologies and data (“Benchmarking Assessment”); and Chapter 3 also provides some background information on the assessment regimes used in the Netherlands and Germany.

In a horizontal BREF it is only possible and appropriate to conclude in general terms on the concepts which will facilitate the application of BAT principles regarding selection of biocides and other additives. Specific installation characteristics, climatic conditions and the local environment are key elements in the determination of a BAT compatible approach at the local level for individual installations.

The justification for the emphasis on biocides in any assessment regime is that their intrinsic properties result in them being considered to be of higher potential concern in terms of impacts on receiving water bodies. At the point of exit, discharges from cooling systems using biocides may exhibit acute toxicity. Local circumstances, the characteristics of the substances employed, and in particular the actual dilution in the receiving water, determine whether Environmental Quality Standards (EQSs) can be met. Proper selection and reduction of potential impacts resulting from biocide use can only be adequately addressed when potential impacts can be assessed. The yardstick by which a BAT-compatible approach to the application of additives/biocides can be judged is the environmental status of the receiving water body.

For the above reasons, the horizontal cooling BREF should provide guidance on how to address site-specific issues in the local level assessment of biocides used in cooling systems. Such a local assessment can be seen as a subsequent, and more detailed step following an (optional) preliminary screening exercise such as the Benchmark Method presented in the Annex VI.1.

Therefore, the BREF aims to provide guidance on the concepts relevant to assessment of local circumstances, without prescribing the methodology itself. Numerous and constantly evolving methodologies and models are available for assessing local level emissions scenarios (ranging from simple to highly sophisticated). It should be up to permit applicants and Member State authorities to select and use methodologies, which are appropriate to the local conditions and the level of concern about potential environmental effects.

VIII.2.2 Key elements

In the context of how to address minimisation of the impact specifically of biocide use in cooling systems according to the principles of BAT, there are two key building blocks that it is important to be aware of:

- The Biocidal Products Directive 98/8/EC (BPD), which since 14/5/2000 has regulated the placing on the European market of biocidal products. In this context, the EU will examine exposure scenarios in order to evaluate the risks associated with all the 23 product-categories which are covered. One of the product-types considered for authorisation covers biocides used in cooling systems (product-type 11). New biocides are to be assessed and approved immediately according to the Directive. An extension has been made for existing substances, which will be reviewed in due course.
- The future Water Framework Directive (WFD), which provides a whole host of quality related objectives. These specifically include a methodology to be used to establish Environmental Quality Standards (EQSs) for chemical substances, which is laid down in Annex V of the WFD text. The methodology for setting EQSs is identical to that used to determine conservative Predicted No Effect Concentrations (PNECs) according to the testing methods laid down in EU chemicals legislation. The method incorporates a “safety factor” of up to 1000 in order to take account of the uncertainties involved in extrapolating from toxicity testing on selected organisms to the protection of the aquatic ecosystem.

Toxicity data for biocides used in cooling systems is either already generally available, or will be made available together with data on other relevant intrinsic properties (e.g. biodegradability, bioaccumulation) according to the registration procedures laid down under the BPD. Based on this data the methodology laid down in Annex V of the WFD can be used to determine the EQS (i.e. the PNEC value) for a substance in water.

The EQS can then be compared to the Predicted Environmental Concentration (PEC) to help determine what potential there may be for impact to occur. Since the EQS corresponds to the PNEC, this is frequently referred to as a “PEC : PNEC comparison”. As noted above, numerous methods are available to calculate the concentration of substances expected to be found in receiving waters as a result of a discharge (i.e. PEC).

The PEC/PNEC value can be used as a yardstick for the BAT determination for a BAT compatible approach for biocides used in cooling systems. It should however be recognised that a certain distinction in this approach has to be made between new and existing installations. A PEC : PNEC value of <1 in the receiving water after realistic mixing & dilution could provide the yardstick (as a limit value) for biocide use in new cooling systems. For existing cooling systems where many design parameters & other installation characteristics are already established it will not always be possible to achieve PEC : PNEC <1 at a cost which is economically viable as described in the definition of BAT. In these cases the PEC : PNEC <1 should remain the target (as a benchmark), but may have to be considered a longer term goal which fits with equipment replacement cycles etc.

Figure VIII.2 shows a graphical presentation giving an example of how a BAT-compatible approach might be determined for the use of biocides in existing cooling systems. Properly optimised operation in a well designed cooling system can be considered BAT when a PEC : PNEC value <1 is achieved. For installations that cannot achieve PEC : PNEC <1 due to sub-optimal design or other local/ site-specific factors, it will be necessary to optimise the operation of the system as far as is feasible.

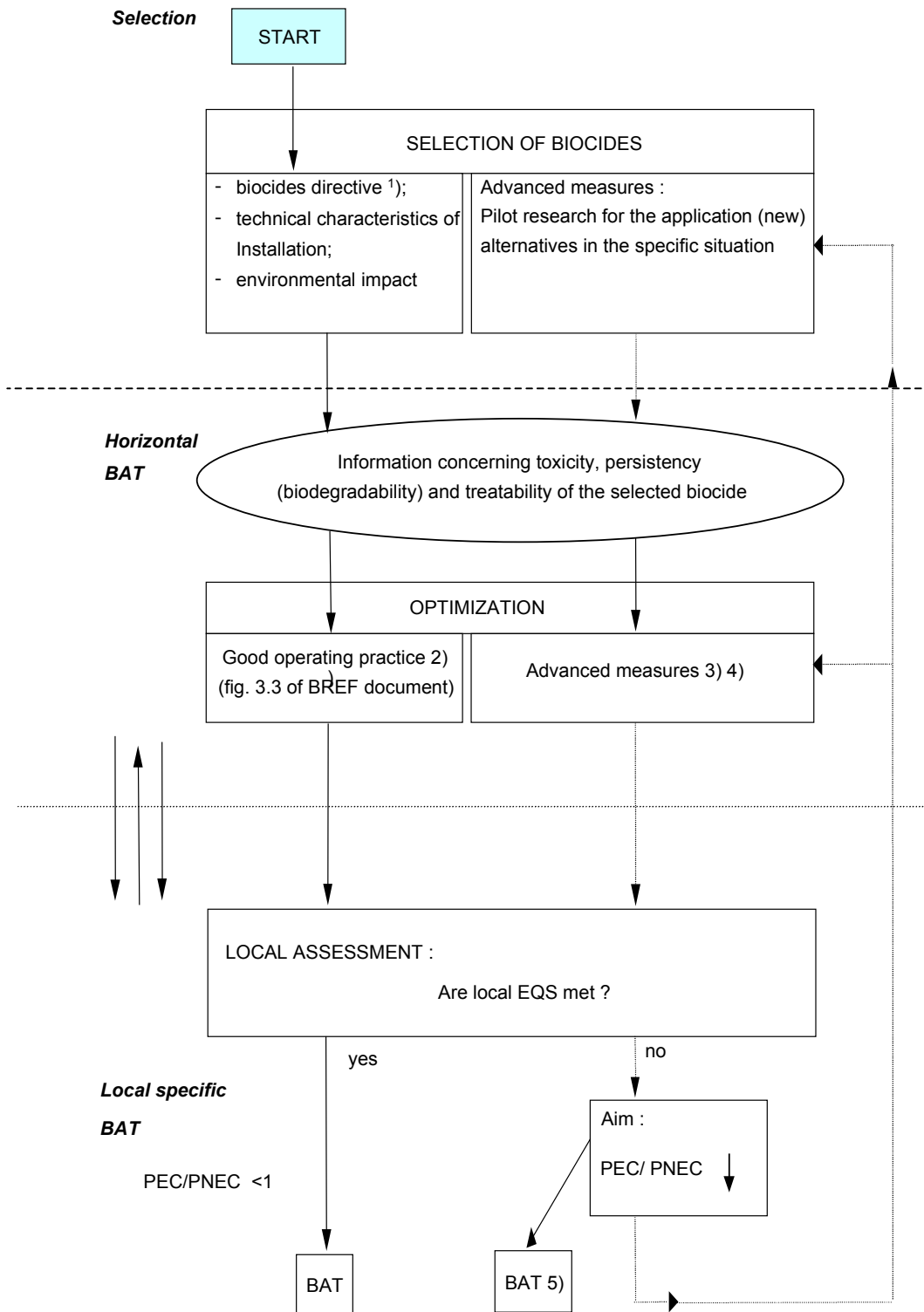

Figure VIII.2: Combined approach for the assessment of cooling water biocides for existing installations

Legend to Figure VIII.2:

- 1) implementation of this directive is under preparation;
- 2) optimisation of the use biocide due to monitoring of parameters relevant for the control of the cooling system and optimisation of dosage (prefer automatic dosage);
- 2) measures such as pretreatment, side-stream filtration can be considered. Also end-of-pipe measures can be taken into account. A choice for a measure is often situation related. A wide variety of end-of-pipe measures can be considered such as biological treatment, sand filtration, adsorption techniques, oxidation by ozone etc. etc.
- 4) in this case (normal) BAT criteria towards measures have to be applied; this means an evaluation of different aspects such as: availability of measures, economic impact of the necessary measures related to environmental impact of a measure;
- 5) in this case if we are dealing with an optimised situation in terms of implementation of measures (process control, optimisation of the use of biocides and implementation of end-of-pipe measures) all within the normal criteria of BAT for abatement measures (see 4). The result of the above evaluation represents the solution which comes closest to the aim $PEC/PNEC = 1$. Other appropriate additives (with less environmental impact) are not available. For this reason this can be considered as BAT for existing installations.

VIII.2.3 Example of proposed local assessment method

[tm004, Baltus and Berbee, 1996] and [tm149, Baltus et al, 1999]

In the following an example has been worked out according to the method which has been discussed at 29-31st May TWG Meeting in Seville and elaborated since that time into the proposal for the assessment of biocides in Annex VII of this BREF.

According to the scheme of the proposal three major steps can be distinguished:

- 1) **The SELECTION OF BIOCIDES:**
The selection of biocides is a tailor made choice for each and every cooling system, and normally is the result of expert discussions between plant operators and chemical suppliers. The benchmark methodology described in appendix VII of this BREF document can be a very use full support tool in the considerations for the selection of biocides. It should be noted that the result of this step is only a first prioritisation of possible biocides. The further elaboration in step 2 and 3 might result in a different order of preference of possible biocides.
- 2) **The OPTIMISATION STEP :**
The optimisation step includes all kinds of process-, dosage- and monitoring techniques as well as purification of make up water, side-stream filtration and process control measures such a temporally closure of the bleed of a recirculation system.
- 3) **The LOCAL ASSESSMENT :**
The local assessment is the final step in the assessment of biocides and provides plant operators, chemical suppliers and regulators a yard stick which enables them to determine to what extent operations, control techniques and measures have to be applied in order to meet local EQSs.

As example the following situation has been elaborated: a recirculating cooling system has to be treated with chemicals to prevent microbiological fouling of the cooling system. The dimensions of the cooling system are presented in Figure VIII.3.

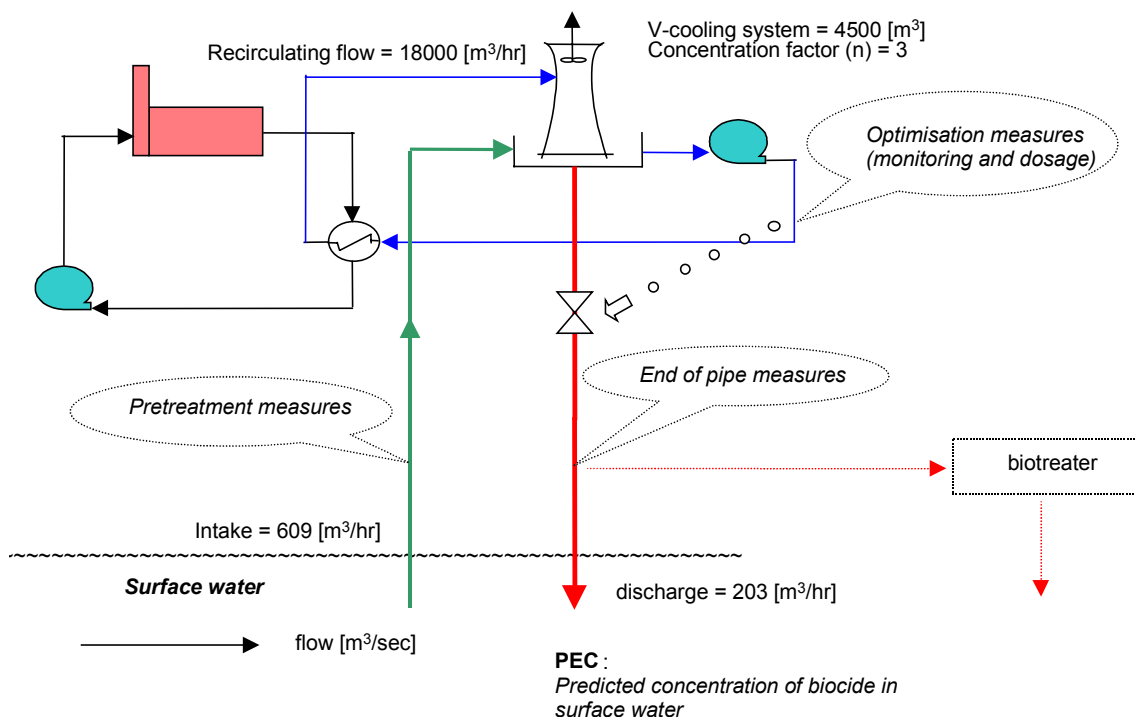

Figure VIII.3: Schematic representation of a recirculating cooling system with the data for the example of a local selection method of cooling systems chemicals

For this example the assumption is made, that the result of step 1 (Benchmark method) resulted in the selection of the biocides hypochlorite in combination with dibromonitrilopropionamide (DBNPA).

The optimisation in terms adequate monitoring and dosage of the hypochlorite shows that the average concentration in the effluent should not exceed a concentration of 0.2 [mg FO/l]. For the non-oxidising biocide DBPNA the optimisation results in a shock dosage at a concentration of 4 [mg/l] (frequency: once a day).

DPBNA is an additive which readily hydrolyses in water ($\tau_{1/2} = 2$ hr). This property of the additive can be a benefit in reducing the emissions from the cooling system and the realisation of a more effective use of the biocide. By closing the discharge during and after dosage for a certain period the concentration of the biocide will be reduced in the system. In this particular case, where DPBNA is been considered, the temporally closure of the bleed provides an additional (optimisation) option to reduce the amount of biocides discharged into the environment. From the operators point of view the question is: to what extent will it be possible to close the bleed of the recirculating system, in order to reduce the concentration of DBPNA through hydrolysis to a sufficient level, without hampering a good operational performance of the cooling system? This sufficient level is a concentration of DPBNA in the effluent leading to a concentration in the recipient (PEC: predicted environmental concentration) which will not exceed the EQS.

In the next table the predicted concentration of DBNPA in several types of surface water is calculated and in the last column the reduction percentage required to meet the EQS for these surface waters has been determined.

Table VIII.3: Predicted concentrations of DBNPA in different surface waters for this example

Situation: Recirculating cooling system ; discharge volume (bleed) : 203 [m ³ /hr]; biocide used : DBPNA ; Dosage : shock (daily) : concentration : 4 [mg/l] ; EQS : 7 [µg/l].							
Receiving water	Dimensions				Dilution after discharge	PEC [µg/l]	Necessary reduction [%] to meet EQS
	Flow [m ³ /sec]	Width [m]	Depth [m]	Velocity [m/sec]			
Average river	25	50	2,6	0,192	110	36,4	80,5
Large river	262	125	3,8	0,552	770	5,2	0
Small river/brook	1	10	1,5	0,067	10	400	98,5
Large canal	40	200	6	0,033	92	43,5	83,9
Small canal	2	25	2	0,04	14	286	97,6
Ditch	0,15	5	1	0,03	3	1333	99,5
Lake	-	-	1,5	0,01	3	1333	99,5

The Table VIII.3 shows that a direct discharge leads to an exceeding of the EQS for most of the selected surface waters. Only a discharge of the effluent in a large river leads to an acceptable concentration of DBPNA in surface water.

For this example the PEC is calculated using a model which is generally excepted in the Netherlands and is used by permitting authorities for a local impact assessment after BAT in a more general sense has been determined (combined approach). The Dutch model is based on the Fisher equations. The PEC is calculated at a distance of 10 times the width of the receiving water system with a maximum of 1000 m (for lakes at a distance of ¼ of the diameter). It is expected that most member states will have their own methodologies or will use dilution factors for different type of recipients to determine the PEC.

The Environmental Quality Standard for DBPNA is calculated according the methodology that has been laid down in Annex V of the Water Framework Directive. The data listed in the table below result in a n EQS for DBNPA of 7 [µg/l]. (one NOEC and 3 acute data result in a safety factor of 100; lowest concentration /100 → 7 [µg/l] [1]).

Table VIII.4: Ecological data of DBNPA

Parameter	Concentration
LC-50 (fish) 96-hr	2 [mg/l]
MIC (algea)	2 [mg/l]
LC-50 (crustacean)	0.7 [mg/l]
NOEC (fish)	4 [mg/l]

Temporarily closure of the bleed of the system is a good option to optimise the use of biocides and to decrease the load of biocides discharged when readily degradable additives are used. In the following table the necessary *time* needed to reduce the emission of biocides to such a level that EQS after discharge can be met in the surface water is presented. In the last column of this table the consequences of this closure in terms of the increase of the salt concentration in the recirculating water has been calculated.

Table VIII.5: Consequences of closing the discharge

Situation: biocide DBPNA : $k = 0,3 \text{ [sec}^{-1}\text{]}$; $\tau_{1/2} = 2 \text{ hr}$; $C_0 = 4 \text{ [mg/l]}$; $C = C_0 * \exp -(Q_v/V+k)*t \text{ [1]}$; $V = \text{volume of the system [m}^3\text{]}$; $Q_v = \text{discharge [m}^3\text{/hr]}$; $t = \text{time [hr]}$.			
Receiving water	Necessary reduction [%]	Necessary time the discharge is closed [hr]	Remarks
Average river	80.5	3.7	increasing concentration of salts : factor 1,2
Large river	0	0	
Small river/brook	98.5	10.7	increasing concentration of salts : factor 1,8
Large canal	83.9	4.3	increasing concentration of salts : factor 1,2
small canal	97.6	9.7	increasing concentration of salts : factor 1,7
Ditch	99.5	14.2	increasing concentration of salts : factor 2,5
Lake	99.5	14.2	increasing concentration of salts : factor 2,5

Depending on the specific situation it has to be evaluated whether or not the above-mentioned consequences in terms of concentration of the inert fraction (salts) are acceptable. On the other hand it is always possible to anticipate on these consequences by means of extra discharge before dosage and closing, which will create lower concentrations of inert fraction in the cooling system.

Further Measures:

If EQS cannot be met it has to be evaluated whether alternative biocides should be considered and/or other measures can be taken.

Examples of measures are:

- pre-treatment of the cooling water used (side-stream filtration);
- optimisation by improvement of dosage and monitoring;
- end-of-pipe treatment, e.g. treatment of blow down in biological treatment.

ANNEX IX EXAMPLE OF A MODEL FOR ESTIMATING EMISSIONS OF BIOCIDES IN THE BLOWDOWN

RIZA developed a simplified model to estimate the discharge of biocides of an open recirculating cooling tower [tm004, Baltus en Berbee, 1996]. This model assumes:

- that the major way by which biocides are lost is via the blowdown and via volatilisation, adsorption etc.
- that this blowdown is very small compared to the circulating amount of water;
- that pH and temperature are constant;
- that with shock dosage, the initial concentration is the same in the entire cooling system immediately after dosage;
- that hydrolysis is a first order chemical reaction and that the resulting dissociation rate is known;
- the volume of the purge is much smaller than the volume of the recirculating water flow.

Resulting from these assumptions, which slightly simplify reality, the following equation could be derived to calculate the fraction of a biocide that will finally be released into the receiving environment:

$$\text{Fraction (\%)} = \Phi_v \times 100 \% / (\Phi_v + kV)$$

Φ_v = purge (m^3/hr)

k = dissociation factor (hr^{-1}) ($k=0$ if substances do not dissociate)

V = volume of the system (m^3)

The difference between 100% of the substance and the actual fraction released is assumed to be hydrolysed. With no other chemical reactions assumed to take place, this model could be seen as describing the worst case. It is realistic to expect the percentage of biocide emitted in reality to be lower than the result of this model. It is important to acknowledge that this is just a model to roughly estimate the discharge and that it does not give any information on the toxicity of the purge. Especially, in the case of largely hydrolysed biocides the resulting substances can be even more harmful than the original treatment.

The dissociation factor (k) is an important factor as it is a measure of the speed with which a biocide disappears from the system by dissociation. If this happens in a very short period of time, it could be worthwhile to close the blowdown and to wait for the moment that the concentration of the biocide reaches its lowest level. To prevent the system from salting up the water in the system should be refreshed just before dosage. The blowdown has to be opened after a few hours to prevent salt concentrations to raise. It is obvious that this is more successful with fast hydrolysing than with slow hydrolysing biocides. Fast hydrolysing biocides are e.g. β -broom- β -nitrostyreen or DBNPA. A slow hydrolysing biocides is e.g. isothiazolines.

Some results from the use of this model were that with a pH of 8 and temperatures between 25-40°C biocides can still be quite persistent and can be emitted in the blowdown for more than 80%. The percentage of fast hydrolysing biocides in the blowdown appeared to be much lower (25%). It shall not be concluded that they are more favourable as their toxicity or that of their dissociation products can be very high and thus create an even less favourable situation in the receiving water.

ANNEX X INVESTMENT COSTS AND OPERATIONAL COSTS OF EQUIPMENT AND ELEMENTS OF COOLING SYSTEMS FOR NON-POWER PLANT APPLICATIONS

[tm001, Bloemkolk, 1997]

In this annex some data are presented on cost data for large industrial cooling systems. Prices in practice will vary widely as indicated by the ranges given. For smaller systems (series) costs on investment and operation will be different again, but will also show a wide variation.

The general picture shows that higher investment costs go together with lower operational costs. It is suggested that this simultaneously could indicate a lower environmental impact.

For each configuration a cost indication has been given, however calculations made on the costs of cooling systems show a wide variety and it can be concluded that the differences in costs between the different systems do not necessarily indicate the least expensive variant. Of the different factors that in the end influence overall costs the users' requirements and the legal requirements to be met are very important. For this reason an estimate of the feasibility of a system or the application of a technique should be made for each individual case. Also, the energy price has to be taken into account and especially in those cases where heat recovery is being considered it plays an important role. Costs are based on the year 1995.

An important aspect in calculating the costs of a cooling system and of possible improvements is the comparison between the initial investment costs of a system (or an applied measure) and the resulting annual costs. In practice high investment costs can lead to lower maintenance costs, but also to higher annual fixed costs, which can be an obstacle to investment itself. For the sake of comparison cost should be expressed in the heat capacity the system is designed for (kW_{th} or MW_{th}).

Elements and costs

For industrial (non-power plant) applications a number of cost-determining elements Table X.1 were listed for both water-cooled and air-cooled systems to calculate total costs and to compare the different systems. The costs are based on the cost levels of the separate parts of a cooling system. In the same reference costs and cost variations of separate elements of cooling systems were described.

Fixed costs

Costs of heat exchangers depend on type, material and size.. Plate heat exchangers are cheaper than shell & tube even in more expensive material such as titanium, but are limited in allowed pressure level. Condensers are approximately 25% more expensive than shell and tube exchangers. Materials such as stainless steel or special CuNi are more expensive than steel (up to 2-5 times). Special tubes may be 10-15% more expensive.

Costs for air-coolers primarily depend on the heat exchanging surface area and the type of fan. The required end temperature is also reported as a deciding factor. The material of the air-cooled heat exchanger generally is less important than in water cooled systems, but this also depends on the corrosiveness of the substance to be cooled.

Costs for conduits and distribution vary strongly with diameter, material and length.

Inlet and outlet provisions are an extremely location-dependent issue. Especially the length, diameter and construction of the supply and drainage pipes can determine the level of the costs. A cost level of about Euro 13000 per MW was indicated for a 300 MW installation. These costs will remain relatively high for smaller installations.

Cooling-water systems are fitted with pumps to pump the water around. Indirect systems have two cooling-water circuits and therefore need extra pumps. Pump investments vary according to

lift, capacity and material. The cleaner the cooling water the less critical is the choice of required materials.

Cooling tower prices strongly depend on model and size. Plume suppression may be required in which case the investments for the cooling tower will be about 1.5-2 times higher. Collection water trays are also part of the cooling tower installation.

The cooling tower price is partially dependent on the design space desired. A smaller approach over the cooling tower leads to a larger and more expensive cooling tower, both as regards the investment for the cooling tower itself, and as a result of energy consumption. The table below shows this with an example:

Variable costs

The variable costs of cooling systems are highly system-dependent. The most striking cost factors are (1995):

- energy (0.05-0.06 euro per kWh)
- groundwater including levy, tax and pumping (0.09-22 euro per m³)
- groundwater excluding pumping (0.09-0.11 euro per m³)
- including levy and tax drinking water (0.4-1.4 euro per m³)
- in some cases, semi-manufactured products are also used, for instance flocculated river water or raised condensation. The costs of these are lower than those of purchased water.

The determining operational aspects of cooling-water systems are the pump energy and, in the case of a cooling tower, the extra ventilator and supplement water. Furthermore cooling water treatment will add to the cost, but this varies on the applied treatment which is associated with the cooling system. Once-through generally only need biofouling control, whereas recirculating systems need additional dispersing and anticorrosion agents.

The operational costs of dry air-cooled systems consist primarily of energy costs. The energy costs of air coolers result from the use of fans. The maintenance costs of air-coolers are one-third to half of those of systems with shell & tubes.

Methodology

Different methodologies have been developed for cost comparisons between different cooling systems. The following approach is used as an example, but other costs methods are based on the same principle. The method is not accurate in absolute terms and, in other words, is not meant to be used for accurate investment estimates. It is however suitable for comparing investment costs of different cooling systems.

For the various systems universal cost factors have to be included and can be expressed as a fixed percentage of the equipment installation costs (Direct Field Costs, or DFC). These cost factors and the associated percentages in this example are:

- indirect costs (5% of investment costs)
- engineering (8% of investment costs)
- unforeseen (15% of equipment installation costs)

The investment costs and the cost factors make up the total investment costs (TIC).

Annual costs are the total of fixed costs (interest + depreciation) and variable (operational) costs. It should be kept in mind that a higher investment not only leads to higher annual fixed costs, but can also be an obstacle to investment itself. Also included in the annual costs are the maintenance costs.

Comparisons

Based on the elements above, the investment for the various cooling systems was calculated and compared. A calculation was also made of the accompanying operational costs. The total is summarised in Table X.2. In calculating annual costs the period of depreciation at a certain

interest has to be applied. The operational costs are also calculated. Annual maintenance costs are based on the total investment costs (TIC).

Table X.1: Cost elements for water and air cooling systems [tm001, Bloemkolk, 1997]

Cost type	Cost elements	Water cooling systems	Air cooling systems	
Fixed	Heat exchanger(s) (type, size and model)	X	x	
	Heat exchanger (material)	X	x	
	Pipelines in process, tube-bridges	X	x	
	Pumps/reserve pumps	X	x	
	Inlet facilities	X		
	Tube intake/drainage	X		
	Outflow facilities	X		
	Cooling tower(s) (possible)	X	x	
	Fans	X	x	
	Sound attenuation	X	x	
	Indirect system (extra heat exchanger, pipes, pumps)	X	x	
	Variable	Water (groundwater, tap water)	X	
Water discharge fee		X		
Leakage monitoring		X	x	
Water conditioning		X		
Energy consumption (pumps and fans)		X	x	
Maintenance		X	x	

Calculations have shown that the investment level and the consumption of energy determine cost sensitivity to a large extent. The variation in the costs of heat exchangers (shell & tube) due to the chosen configuration and to the choice of material is very important. Cheap materials and models determine the calculated lower limits and special materials determine the upper limit. At the same time it should not be forgotten that good materials could considerably decrease the costs of maintenance and operating, and of the use of chemicals.

Calculated as annual costs, investments and operational costs differ significantly. Factors such as (make-up) water requirement and price, and energy consumption are influential. The choice of material also has consequences for the annual operating costs. In the case dry air-cooling is applied, the achievable end temperature is important and the lower the required end temperature, the more expensive air-cooling will become. With water-cooling, low end-temperature have less affect for cost estimations, unless small approaches are used in the calculation.

Table X.2: Cost indications for water and air cooling systems for industrial applications with the exception of power plants (1993-1995)
 [tm001, Bloemkolk, 1997]

System	Installation x 1000 (EUR/MW _{th})	Total investment (TIC) x 1000 (EUR/MW _{th})	Investment determined by	Operational costs x 1000 (EUR/MW _{th})	Interest and depreciation ⁶ x 1000 (EUR/MW _{th}) per year	General total annual costs (EUR/MW _{th})
Once-through (range 0.2- 10 MW _{th}) (range > 10 MW _{th}) to elements -heat exchangers ² -tubes etc. -pumps -supply/drainage	68 – 182 34 - 91 68 (36 - 136) 9.1 - 14 4.5 - 9.1 (9.1 - 14) ¹		- material, model - length, material - capacity, DP - location (supply/drainage)	- energy 4.5 - 6.8 - conditioning 0.5 - 1.8 - maintenance ⁵ 2.7 – 7.7		
Total	59 - 173	77 - 227		7.7 -16	10 - 30	18 - 46
Indirect once-through	18 - 50 ^{2,3} (extra)		extra heat exchangers			
Total		100 - 269	extra heat exchangers	10 - 19	13 - 37	23 - 56
Recirculating with open wet cooling tower (range 0.2-1 MW _{th}) (range>1MW _{th}) to elements -cool tower -heat exchangers -tubes/pumps	59 - 136 45 - 68 18 - 45 ⁴ 36 – 136 14 - 23		- model - material, model - material heat exchangers	- supplement 6.3 - 22 - energy 6.5 - 13 - maintenance 2.3 - 9.1 - conditioning 1.8 - 4.5		
Total	68 - 203	89 - 266		19-41	11-35	30-76
Indirect recirculating with open wet cooling tower	18- 45 ^{2,3} (extra)		extra heat exchangers extra pumps	- energy 9.3 - 16 - maintenance 2.7 – 11 - conditioning 1.8 – 4.5 - supplement 6.3 – 22		
Total	86-255	112 - 331		20 - 43	14-43	34-86

Table X.2 continued

System	Installation x 1000 (EUR/MW _{th})	Total investment (TIC) x 1000 (EUR/MW _{th})	Investment determined by	Operational costs x 1000 (EUR/MW _{th})	Interest and depreciation ⁶ x 1000 (EUR/MW _{th}) per year	General total annual costs (EUR/MW _{th})
Dry air cooling						
Direct			end temperature ⁸	- energy 1.4 - 5.4 - maintenance 1.4 - 3.4 ⁵		
Total	81-220	105-288		2.8 - 8.8	14-38	17- 47
Indirect	extra 14-45 ^{2,3}		end temperature ⁸	- energy 3.6 - 8.9 - maintenance 1.8 - 5.4		
Total	95-266	123-351		5.4- 14.3	16-46	21-60

1. see text
2. costs for extra heat exchanger depending on type
General costs factors materials:
 - steel 1 special (bv Cu/Ni alloy) 1.5-5.0
 - coated steel 1.3-1.7 copper 1.5-2
 - rvs 304/316 1.5-3 titanium 1.7-2.5
3. cost depend on heat exchanger plus extra pumps and distribution; often plate heat exchangers.
4. system is factor 2-2.5 times more expensive with steam plume suppression
5. maintenance costs 3.5%; for air-cooling 1-1.5%
6. assumes depreciation at 5% interest, where the annual fixed costs come to approx. 13% of the investments (annuities).
7. number of operating hours per year 8000
8. upper price limit for deep cooling functions up to 30° C; lower price limit for 60° C
9. no cost data known

ANNEX XI EXAMPLES OF TECHNIQUES TO BE CONSIDERED WITHIN THE PRIMARY BAT APPROACH FOR INDUSTRIAL COOLING SYSTEMS

XI.1 Introduction

Many options are available for reduction of the environmental effects of industrial cooling systems. The general approach aims at prevention by proper design and construction, which in case of new industrial cooling systems is generally easier to achieve than for existing systems. The application of reduction measures depends on the cooling configuration as well as on-site related limits, such as space. Other factors such as energy consumption, operational requirements and economics will play an important role as well. Based on the general approach presented in chapter 1 and applied to reduce environmental impact as described in chapter 3 this Annex describes techniques and alternatives in more detail. The techniques can be considered in the optimisation of cooling systems in line with the BAT-approach.

The list is an overview of the more detailed information on a number of reduction techniques brought forward by the TWG in the exchange of information on BAT for industrial cooling systems. For each technique that has been reported by the TWG a short description is given followed by the reducing effect (quantitatively/qualitatively), cross-media effects, plant size limits, costs, and example plants. Similar to the assessment of the appropriate cooling technique the application of any of the techniques presented hereafter will have to be assessed in the light of the cooling configuration used or planned. As far as selecting between techniques with a similar environmental objective is possible, their environmental performance and their technical applicability should be the initial selecting criteria followed by investment and maintenance costs and the crossover effects on other environmental compartments. Generally, for many of the techniques described neither cost data, nor cross-media effects were as yet available and need further research.

With respect to the application and feasibility of the techniques care must be taken. The environmental results obtained are achieved under certain process conditions and give no guarantee for similar quantitative results in a different process environment. The results are useful to illustrate the direction of the improvement. Particularly in the case of industrial cooling systems, process requirements and cooling system's size and operation vary widely and will affect the results of any abatement measure applied.

XI.2 Cooling water savings through water reuse

The use of water for cooling is or might become restricted either in general or, temporarily, by seasonal changes in availability thus creating periodic shortage. In several European Member States an increasing pressure is put on industry to limit and optimise their water use. Thus, emphasis has been placed on industry to change the technology and change once-through systems into recirculating cooling systems if possible or to operate their recirculating cooling towers at higher cycles of concentration. Other options in cooling towers that are commonly applied are drift eliminators.

Also, a number of water treatment options can be to regain the water used and prepare it for re-use in the cooling cycle. Also, some policies aim at increasing the share of dry air cooling, where this does not require water and thus none of the associated problems, whereas other considerations might be a limit for this option (climate, investment costs, space).

An overview of treatment methods revealed the following options [tm065, Meier and Fulks, 1990]:

- Cold lime-softening
- Hot process softening
- Brine concentrators
- Biological treatment
- Reverse osmosis
- Electro-dialysis reversal
- Evaporation ponds

Of these options reverse osmosis and electro-dialysis reversal are very energy demanding processes and thus turn out to be relatively expensive. Hot process softening is very efficient, but has the disadvantage that additional cooling or heat recovery is necessary. Biological treatment is used to remove organic matter from water and is especially interesting as part of a treatment programme for wastewater treatment effluent to be used as make-up water. Evaporation ponds are an easy method of plant effluent reduction. Their size requirements and limits to the disposal of the remaining sludge may prohibit their use.

XI.2.1 Reuse of (waste) water for cooling tower make-up

[tm066, Phillips and Strittmatter, 1994] and [tm064, Meier, 1990]

Description

Water from within or outside the plant can be used as make-up water for cooling towers. Both process effluents from within the same plant as well as effluents of municipal wastewater treatment plants can be applied. The chemistry of the water is important. A water audit can provide a complete water balance for each portion of the plant. This audit should give information including the tower water chemistry, on cycles of concentration, holding time index, velocity, system metallurgy, temperatures and the current treatment chemistry and operating performance. Some times the water needs to be filtered first and a wide range of filtration methods can be applied, but in the scope of this paper are not addressed.

The chemistry of the water decides upon the chemical treatment required in the cooling tower to maintain the number of cycles. Especially, an increasing corrosivity level has been reported to occur. In some cases the limiting concentration factor can be extended by using scale inhibitors to increase the cycles of concentration or by using techniques as reverse osmosis to remove dissolved solids.

Reduction:

The percentage of reduction is largely depending on the demand of the recirculating cooling system and the availability of reusable water at the required moment. Percentages of up to 15% are being reported.

Cross-media effects:

Waste as filter-residue due to filtering the water before use might have to be disposed. The saving of fresh water use will have to be assessed against the environmental and financial costs of the extra use of additives to condition the waste-water. The chemical treatment of the stream to be reused can be very complex and may require extra manpower to operate the system.

Application limits:

Water reuse is an option for both new and existing plants and irrespective of plant size, although for larger demands the supply of alternative water resources might not be sufficient. Organic content (BOD) can be a limiting factor that must be checked.

Costs:

Cost indications vary widely and are quite specific for the plant. No indicative data are known.

Example plants:

For refineries it has been demonstrated that municipal waste water can be used as make-up water [066, Phillips and Strittmatter, 1994]. An example of applying zero blowdown was described in [tm064, Meier, 1990].

Considerations:

Typical problems to be encountered using waste streams are:

- the higher microbiological activity due to dissolved nutrients;
- increased risk of scaling due to increased level of dissolved salts
- fouling problems as a result of high levels of iron and/or suspended solids;
- corrosion problems due to high levels of total dissolved solids (TDS).

Possibilities to encounter the aforementioned problems successfully depend on the composition of the waste stream. Municipal waste waters will differ greatly in water quality (it contains typically relatively high levels of ammonia and phosphate, in addition to significant levels of dissolved organic matter. Furthermore, municipal wastewater typically contains relatively high concentration hardness, which may cause scaling. High levels of iron and/or suspended solids can lead to fouling problems. Total effluent of a refinery may contain high oil and grease and suspended solids levels, which may increase the demand for oxidising biocides.

XI.2.2 Zero discharge system

[comment, D]

Description:

A staged cooling system is used to eliminate any liquid discharge from the cooling tower blowdown.

Blowdown from the primary tower is performed to maintain the balance of salts within the limits of good operating practice. Water which has a high level of highly insoluble salts (calcium salts) is converted to water which has a high level of highly soluble salts (Sodium salts). This process occurs in a softener reactor/clarifier.

After this the blowdown flows to a direct osmosis (DO) membrane concentrator which pulls water from the blow down through membranes into a sodium chloride brine. The brine is reconcentrated in a secondary cooling tower, the so called brine cooling tower, using waste heat from the main condenser as an energy source. The brine cooling tower will have a much lower waterflow than the primary tower. A typical ratio of the brine flow to the primary flow is 1 to 750.

The concentrate from the DO membrane system is further concentrated in a small crystallizer, with the solids being removed and disposed of off-site. The liquid discharge of the crystallizer is recycled to the brine tower.

Reduction:

The reuse of primary blowdown water is reported to be about 75%, where the remaining part evaporates in the secondary cooling tower (about 16%) or is contained as residual humidity in the solid disposal.

Using waste heat in the brine-cooling tower reduces the cooling load on the primary tower with about 3.5 MW at a blowdown of 45m³/h.

Cross-media effects:

Lower cooling load on the primary tower. Some energy is required to operate the staged cooling system. Emissions in the blowdown are not discharged in a receiving surface water but transformed into waste. Waste will need a way for disposal.

Application limits:

The system will be efficient where strict environmental limits exist with regard to waste water discharge. The system is an option for new power and chemical plants, but can be a retrofit option for existing installations.

Costs:

The capital investment for this system is higher than for stand-alone wet cooling towers. It is claimed that the capital investment costs of a wet cooling tower with this system are significantly lower than for an air-cooled system of the same capacity. Operating costs with respect to power requirements can be lower due to the use of waste heat of the main condenser. The operating costs of the staged cooling system and the costs of the disposal of solids are to be assessed against the environmental costs for conditioning and discharging the wastewater.

Example plant:

Within the European Community no installation is reported to exist. Several applications can be found in the USA.

Considerations:

In conventional technologies for water reuse (for instance brine concentrators) the high temperature brines that are generated are extremely corrosive, leading to exotic materials and continuing maintenance issues. In the system described, the low pressure (ca. 1.5 bar) and low temperatures (less than 32°C) operation of the DO allows the use of HDPE PVC and other non-corrosive materials in areas where corrosion may be of concern. Further experiences are that the crystallizer is smaller than in conventional systems. Both lead to lower maintenance.

Operation is simple and does not require specialised training. No additional biological treatment is required.

It needs local consideration if the environmental costs of no discharge to the surface water outweigh the environmental costs of waste disposal.

XI.2.3 Spray ponds

[tm154, Besselink et al, 1999]

Description:

In the past spray ponds have been used to cool down the cooling water and some may still be operated in Europe. Currently research is carried out on the applicability of spray ponds for industrial use to reduce the thermal discharge and to save water. A feasibility study looks into the use of a spray pond and into the energy saving compared to a cooling tower with a capacity of 18-21 MW_{th}. A model has been developed that calculates the cooling efficiency of a spray pond depending on weather conditions, on the dimensions of the spray nozzles and on the characteristics of the spray pond (surface area, water quality). With the model it should then be possible for any specific local conditions to design the required spray pond.

All or part of the cooling water flow is led to a pond through spraying nozzles. The spraying enhances the cooling and theoretically the cooling efficiency of a spray pond is about 36 times higher than that of cooling pond. Spray ponds cool by evaporation, conduction and convection. Evaporation is most important at high air temperatures, but conduction and convection are more important under cold weather conditions. The capacity depends on surface, weather conditions (wind speed), spray nozzles and spraying characteristics. The heat dissipation of an effective spray pond can amount to 722 J/m²K.

Reduction:

Results for the studied cooling system show a potential energy saving compared to the energy use of a cooling tower that can amount to approximately 6.5 kW_e per MW_{th} of cooling. This is equivalent with a decrease of CO₂-emissions of about 38 tons per MW_{th} per year.

Cross-media effect:

By spraying the water aerosols occur. They play an important role in the spreading of biological contamination. Therefore, and particularly in summer, operating a spray pond needs an adequate water treatment programme.

Application:

Lack of sufficient space on-site will limit the options for a spray pond depending on the required capacity of the cooling system. For large systems it may not be an option for the entire but for part of the cooling water need and can reduce the water intake. In the US several conventional power plants (up to 500 MW_e) use spray ponds, nuclear power stations use them for emergency cooling.

Costs:

Spray pond investments are slightly advantageous to cooling tower investments if it includes the costs for power supply and also considering the costs for purchase of land. The difference is larger in case purchase of land is not taken into consideration, but this of course is dependent on the price of land.

Table XI.1: Investment and energy costs per MW_{th} for spray pond and cooling tower [tm154, Besselink et al, 1999]

Costs	Spray pond	Cooling tower
Investment ('000 EUR/MW _{th})	39 (25)	48
Spraying and fan energy (kWe/MW _{th})	4	11
Designability	reliable	Reliable
Notes: Capacity 18-21 MW _{th} Cooling from 32°C to 24°C		

Reference plant:

Dow Europe, Terneuzen (NL).

Considerations:

Although based on an existing technique the current modifications are still in a stage of research. Application could be particularly interesting in those circumstances where restrictions of heat discharge may lead to restrictions in production capacity, which occurs during summer months with power plants. Also, a spray pond may be considered with the expected increase in restrictions on the use of groundwater.

XI.2.4 Cold storage

[Comment-1, Belgium]

Description:

A special application for smaller industrial use is the underground storage of water to cool it down. Here groundwater, warmed up after use, is stored at an adjacent location underground for an extensive period of time, where it cools off. It is also possible to cool the water above ground, using air coolers in winter, for instance, after which the water is stored underground and used (in summer). This application is mainly used when there is need for cooling at a level of about 6 - 9° C.

Reduction:

Reduction of energy and operating costs reported to be 40- to 80% less compared to using small cooling towers.

Cross-media effect:

unknown

Application limits:

Application becomes interesting above a minimum of 150 kW and as addition to cooling with cooling towers in case of industrial application. Cooling of several MW has already been realised. As yet, use is limited. Examples are utility construction and greenhouse horticulture.

Costs:

Not indicated

Reference plant:

Not available

Considerations:

Technique is still in stage of development. Full industrial application was not mentioned.

XI.3 Reduction of emissions through optimized cooling water treatment

In the introduction to the paragraph on cooling water savings a number of treatments were listed that can be applied to prepare effluent to be re-used as make-up for recirculating cooling systems. The same techniques could be applied to water from a natural source to optimise the chemistry of the water at the same time minimising the need for an extensive water treatment programme. As presented before the application is strongly related to the chemistry of the water and the demand of the cooling system.

XI.3.1 Side-stream-biofiltration in an open recirculating cooling water system

[tm 146,Savelkoul, 1999]

Description:

For many reasons it is economically interesting to operate an open recirculating cooling system on a minimum blowdown level. This however results in increased biological activity in the cooling water, which often is treated by applying biocides.

Amongst other factors, biological activity and growth is primarily dependent on the availability of nutrients. Irrespective of the cooling system, water circulation or climate, biological activity will not survive under conditions of nutrient shortage. Every treatment therefore should aim at a reduction of the biological growth by removal of dissolved nutrients from the cooling water circuit. For an effective treatment the so-called dead volume (or the circuit volume) of the cooling water system is important. It is in fact, this dead volume that is treated in a filter and subsequently chlorinated at low levels and frequency.

This can be done by applying a continuous sand filter on a side-stream breaking down the dissolved nutrients and at the same time filtering suspended micro-organisms and other dissolved solids. Consequently less chlorine is needed and higher cycles of concentration are possible.

This technique can be improved by creating an active biology in the sandfilter with a high concentration of micro-organisms, which is called side-stream biofiltration. To maintain an active biology the sand filters are by-passed during periods of high concentration levels of biocide (chlorine) in the cooling water circuit, because this high level would break down the biology in the sand filter as well as their effect in the cooling water. As soon as the chlorine-level is reduced the cooling water is led through the sandfilter again. In effect it means that the cooling water only needs to pass the filter a limited number of times down to once or twice a day only.

The application has been applied to an open recirculating system with a capacity of 152 MW_{th}, a water circulation of 11000 m³/h and a circuit volume of 3500 m³. The case system applied two filters of 5 m² of filtersurface and about 10 kg VSS/m³ of filter, 4 m filterbed height, filtering sand (of 1.4-2.0 mm and 0.8 – 1.25 mm). The design model was based on the first order reaction mechanism of nutrients removal with a reaction rate constant of 6.0 /heure (= sand 0.8 – 1.25 mm, so 3.800 m²/m³) and 4.5 /heure (= for sand of 1.4 – 2.0 mm, so 2.250 m²/m³) in the sand filter. This significantly decreased the growth rate of organisms at the filter effluent side compared with the circulating water.

Reduction:

The resulting reductions depended on the optimized combination of blowdown, biocide use and application of side-stream biofiltration. For example, the functioning of the sandfilter depends on the side-streamflow, washwaterflow, sandcirculation, filter resistance and water temperature. The efficiency of the filter is reduced by higher through flow (higher hydraulic pressure), which is similar to a lower contact period, and by using larger sandparticles, which means a lower specific surface.

Results show an increased concentration factor (5.0 to 5.5) with a simultaneous reduction of Cl⁻ dosage frequency of less than once every two days (0.42/day). This means a reduced blowdown of 12 %, reduced water intake of 2.4% and reduced additive use of 12% or seven times less chlorine for the same effect.

Due to the lower dosage of chlorine, the level of corrosive elements (expressed as the summation chlorine and sulphate) remain within the required range for that system (max. 86 ppm Cl⁻ and 77 ppm HSO₄⁻ respectively). This explains the achieved 12 % reduced blowdown due to the biofilter, which is based on the same corrosiveness of the water.

Cross-media effect:

If the starting point for application of side-stream biofiltration is to reduce the amount of chlorination, all other results mentioned are regarded as positive cross-media effects. Data on extra energy requirements for pumps were not mentioned.

Separate pumping equipment is avoided and the performance of the biofilter is maximised by sending the hot effluent cooling water directly to the side-stream filter and this filter effluent is sent directly to the cooling tower basin. A slip stream of hot filter effluent is then de facto bypassing the cooling tower fill and will warm up the cooling tower basin with average 0.15 K, which is equivalent with an increased indirect energy usage of 0.5 kW_{th}/MW_{th cooling}. A separate pump to transport the biofilter effluent back to the cooling tower header where the static pressure is 14 mwg, can avoid this drawback. On average, 1½ m³/hr per MW_{th cooling} have to be pumped, which is equivalent with a direct energy consumption of 0.1 kW_e/MW_{th cooling} or 0.25 kW_{th}/MW_{th cooling} (with 40% efficiency of power plant). This is also quite limited in comparison with the standard (in) direct energy use for cooling tower processes.

The saved energy based on the decreased sodium hypochlorite consumption is also very limited (a 1 litre 15 % solution per day per MW_{th cooling} is equivalent with the oxidant “production” of 1 kW_{th} for one hour per day per MW_{th cooling} or 0.04 kW_{th}/MW_{th cooling}). The saved energy, based on the reduced make-up due to the 12 % reduced blowdown of 0.04 m³/hr per MW_{th}, is also negligible even if the transportation energy of the reduced make-up is included.

In general, the net energy balance of all these energy differences due to the biofilter are negligible and in the magnitude of 1% of the standard direct energy consumption for cooling tower processes of 20 kW_{th}/MW_{th cooling} (See Table 3.2). These small numbers are expected since only 1 to 2 % of the cooling water circulation flow is in general necessary for the biofilter to avoid microfouling in the heat exchangers.

Application limits:

With a corresponding upgrading of the filter capacity there does not seem to be an application limit. It can be applied to existing cooling systems.

Costs:

Costs depend on the scale of application and the results obtained as expressed in reduced operating costs. The operational costs of chlorination were reduced with 85 %. For the given example the expected investment return period was estimated to be three to four years.

Reference plant:

DSM, Geleen (Netherlands) and Dow Benelux, Terneuzen (Netherlands)

Considerations:

The side-stream filter was designed on a purposely chosen low efficiency removal of nutrients, by choosing a high linear velocity of 25 m/hour, instead of the standard of 10 - 14 m/hour, which is normally applied for suspended matter removal only. High removal rates of nutrients will be achieved with a counter-current sand bed filter, if the influent is at least above 200 RLU as ATP (= colony counts units expressed as decrease of adenosine tri phosphate) and preferably 600 RLU as a criteria to start the shock dosage of sodium hypochlorite. This occurs together with the high linear velocities to prevent anaerobic conditions.

The chlorination criteria of the cooling tower system, without a side-stream biofilter, was on halving the micro organisms expressed as 500 to 250 RLU as ATP by means of a first order reaction ($= 0.5 [1/\text{hour}]$), which was achieved with 1 litre sodiumhypochlorite solution of 15% per MW_{th} for every shockdosage.

The organic load on the filterbed becomes 10 kg organics per m^3 filter bed, and together with a desired contact time of 10 minutes it becomes necessary to design a sand height of 4 m, which influences the capital cost lesser than enlarging the filter diameter. The filter surface was for every 15 MW_{th} 1 m^2 , which results in 1.7 m^3/hour filtration flow per MW_{th} , and this is almost equal to the evaporation rate of 1.3 m^3/hour per MW_{th} together with a slightly decreased blowdown of 0.3 m^3/hour due to the installed filter. In fact every drop of circulating cooling water passes the side-stream filter 1.7 times a day. By doing so, the hydraulic half time of the whole cooling system decreases from 40 to 7 hours. At the same time the blowdownrate decreased with 12% as well as the conditioning chemicals and the frequency of chlorination decreased drastically from 3 times a day to only once every 2.4 days. The corrosiveness of the circulating cooling water, expressed as the summation of chlorine and sulphate, remains the same.

Based on this model, the outcome for most existing cooling towers systems in Europe will be in the magnitude of 1 - 2 times per day that the known dead water volume as warm water will pass over the filter. This will occur together with a limited one hourly shock dosage of an oxidative biocide only twice a week. Expressed in units: 1 m^2 filter surface only per 15 MW_{th} is expected to be sufficient in most cases together with a filter height of 4 m to create a residence time of several minutes. For a common situation, the reduction in water and chemical usage delivers a pay back time of 3 - 4 years for the capital cost of the side-stream filter. It is expected that other filtermedia then sand like basalt can result in even smaller filters per MW_{th} .

XI.3.2 Physical methods

Cleaning devices for water cooled systems can be on-line (or continuous) cleaning such as the use of sponge rubber balls or brushes, or off-line cleaning by using for instance high-pressure water jets and shooting of so-called 'pigs' through the condenser tubes. The better the cleaning the less need there is for application of cooling water chemicals, not only because fouling of the tube surface is removed mechanically, but also because the applied additives will be more effective as they can reach the surface more easily. It has been stated that mechanical cleaning could be considered as a prerequisite for the use of a macrofouling control programme.

Cleaning of dry air cooling systems is restricted to the fin side of the heat transfer surface. For maintenance of the heat transfer (also avoiding indirect emissions) and longevity of the coils cleaning should be implemented.

A number of physical methods to combat macrofouling and the experiences in industry are listed Table XI.2. [005, Van Donk and Jenner, 1996]

- Reducing entrainment of (bio)fouling in the system. Intake structures should be designed in such a way that entrainment of fish, debris, organic and inorganic material, including suspended matter is kept to a minimum. Additionally, side-stream filtration can be an option in open recirculating systems.
- Maintaining velocities at a level high enough to avoid fixation of organic organisms (velocity higher than 2 m/s). Too high velocities, however, may introduce a risk of corrosion. Critical water velocities depend very much on the type of material used.
- Sudden temperature increase by raising the temperature of the cooling water beyond 40 °C for some dozens of minutes; this technique eliminates the fixed organisms (mussels), but nevertheless requires an appropriate design of the cooling system (recirculation of the cooling water). Also it limits the cooling capacity of the system and can only be done during an interruption in the process in case this cannot withstand a rise in temperature.
- Non-toxic coating and paints, which reduce the fixation of the organism, reinforce the velocity effect and facilitate cleaning.
- The use of sonic technology. The principle underlying the application of sound is that the vibration created by the energy associated with the transmission of sound will remove deposits on surfaces, by 'shaking' the deposit free.
- Osmotic shock. This physical-chemical based method applies osmotic shock by either fresh- or seawater systems, by subjecting them to seawater and freshwater, respectively. As a result, cells of organism may come under the effects of internal pressure, which may result in death.

**Table XI.2: Physical techniques to minimize biocide use
(derived from [tm005, Van Donk and Jenner, 1996])**

Technique	Equipment	Field experience	Possibilities/Restrictions
Filtration/water pretreatment	Macrofouling: drumscreens, band sieves, trashracks, mussel sieves	Yes, power station	Both for once-through and recirculating cooling water systems
	Microfouling: rotating drum and sand filters	Yes, chemical industry	Not for large once-through systems
	Microfouling: continuous backwashed microfilters (50-100 μ m)	Yes, desalination plant	For water flows up to 4 m ³ /s
Side-stream filtration	Rapid sand filters	Yes, chemical industry	Only recirculating systems All biocides Filter can become added source of bacteria
	Continuous backwashed filters	Yes, glass industry	
On-line cleaning	Sponge rubber balls	Yes, power stations	Large once-through Not for open recirculating
	Brush and cage system	Limited, chemical industry and power plant	Once-through and recirculating cooling systems
Off-line cleaning		Yes, power stations and industry	Needs double lay-out or regular operation stops
Heat treatment	Macrofouling: 38-40°C	Yes, seawater and fresh water systems	Option restricted to new systems, needs special design;
	Microfouling: 70-80°C	?	Replacement for biocides
Coatings and paints	Toxic coatings	Varying	Based on zinc and copper, use might be restricted against micro- and macrofouling
	Non-toxic coating	Power stations in U.S.	For new systems; fouling releasing; Silicone based and susceptible
U.V. light		Small scale tests	Preventative additional technique to chemical biofouling control in recirculating cooling water systems
Sonic technology		No, only test results	High energy costs
Electric water treatment	High frequency transformer	No, only test results	Test results in small industrial system
Osmotic shock		Yes, once-through system using sea-water	Materials need to be corrosion-resistant Fresh water system might corrode if treated with sea-water

XI.3.3 Optimization of biocide use

XI.3.3.1 Monitoring

[tm005, Van Donk and Jenner, 1996]

For monitoring of microfouling the plate count technique and the ATP measurement are used. For monitoring of macrofouling use is made of exposure panels or glass windows. Scaling and corrosion indirectly influence biocide use and therefore monitoring of the occurrence of these effects can also be important to measure the occurrence of biofouling. Examples of monitoring techniques given in the reference are the KEMA Biofouling Monitor[®] and underwater video equipped robotic devices are used to detect macrofouling, and effects of biocide treatment. For more accurate measurements particularly for microfouling and biocide treatment techniques are applied using features as valve movement and as light emission of microorganisms as a result of their metabolic process. Of both techniques an example is given to illustrate the principle, but many more are on the market.

XI.3.3.1.1 Monitoring of macrofouling

[tm157, Jenner e.a., 1998]

To be able to target the dosing of biocides to combat macrofouling in once-through systems a so-called biofouling monitoring system has been developed. The KEMA Biofouling[®] Monitor consists of a closed cylindrical container, made of PVC, with a vertical water flow from top to bottom. It can be used to monitor all macrofouling organisms in freshwater, brackish water and seawater systems. It allows direct observation, weekly and monthly counts of bivalve spat settlement. Spat are the metamorphosed larvae of the last larval stages of bivalves (so called "pediveligers"). In order to obtain adequate information on macrofouling development in the cooling system it is recommended to place a biofouling monitor at the intake, before the dosing point, and another one at a critical spot in the cooling system, after the dosing point.

When installed parallel to a cooling water conduit as a bypass, the monitor is an effective tool to detect all possible macrofouling in the cooling system. The water velocity in the monitor is much lower than in the cooling system. This provides an optimal environment for settlement of bivalve-spat, and allows easy inspection of the point of time of settlement, growth, and effectiveness of control measures. Based on the information from the monitor biocide application can be limited to the periods where it is really necessary. Further research on the behaviour of the organisms can further target the dosage concentration of the biocide.

Other techniques are applied, such as those using immersed plates near the inlet channels. They give the operator of the plant an indication of the periods when to avoid chlorination.

XI.3.3.1.2 Traced biocides for biocide and microbiological activity

[tm096, McCoy e.a, 1995]

The tracer diagnostic system consists of an analyser, a data collection system, analytical software and a luminescent reagent. The analyser measures the light output of the microorganisms. Within minutes, the test can determine biocide concentration and biological activity in the cooling water. The method is based on a bioluminescence bioassay of biocide active ingredient. It is aimed at optimising the use of non-oxidising biocides in recirculating cooling systems by measuring systems' consumption.

XI.3.3.2 Biocide dosage

XI.3.3.2.1 Different conditioning regimes to obtain optimum annual total oxidant use in once-through systems against macro- and microfouling

To avoid macro- as well as microfouling different conditioning regimes can be applied in once-through cooling water systems. This can be low-level chlorination executed as continuous, semi-continuous as well as discontinuous, also called shock chlorination, of twice an half hour a day, targeted chlorination in only a part of the heat exchanger or a part of the cooling system itself,

pulse-chlorination and alternating pulse-chlorination. The different regimes objectives are to achieve and remain a high energy efficiency by operating with clean heat exchangers through the year and at the same time minimise adverse environmental effects.

The environmental assessment of chlorination can be split into two main categories: oxidants and non-oxidants. They differ in their ecotoxicological risk expressed as component life time, bioaccumulation and toxicity towards aquatic organisms. The non-oxidants like chlorinated hydrocarbons are persistent and some components will accumulate in the fats of aquatic organisms as well as show a chronicle mutagenic and carcinogenic toxicity. The oxidants react quite rapidly with reductants and will only be available for antifouling after overstoichiometric dosage. Only under those circumstances the result of the dosage is acute toxic at even low concentrations, but without bioaccumulation of the free oxidants.

Acute toxicity is what is needed in the cooling system including the heat exchangers to prevent settlement and to keep the heat exchangers clean, but this toxicity is unwanted in the cooling water discharge.

Since even a continuous low-level chlorination regime has a significant low PEC/PNEC ratio, the main environmental issue is to reduce the formation of halogenated hydrocarbons, also called chlorinated by-products, which are due to the inefficiently used oxidant mass. However, these components are not measured easily on a regular or even continuous basis and also don't have any potential acute toxicity. Therefore, performance of a conditioning regime is monitored in terms of free oxidants, which is also more applicable on a continuous control basis. All oxidative conditioning regimes have in common that continuous measurement of free oxidants is favoured regarding the necessary process control. At the same time natural waters have a minimum detection limit and threshold around 0.1 mg/l ($\pm 0,05$ mg/l) depending on the applied analytical technique and in relation to components present in the natural cooling water that have no direct contribution to the effect of the conditioning regime itself. Since chlorine just like other oxidants is non-selective and non-specific and reacts practically with all reducible components present in (natural) waters and together with the analytical threshold, this can be an explanation why reported successful conditioning regimes use at least 0.2 mg/l free oxidants before the condensers.

Production of the halogenated hydrocarbons is an almost linear function of the dosed oxidant mass irrespective of the conditioning regime.

Comparing discontinuous and continuous low level conditioning regimes it may look as if a discontinuous conditioning regime (with higher oxidant mass) results in a higher measurable concentration of halogenated by-products. If the mass balance is corrected for those periods that the dosage was stopped, then the yearly-emitted mass of a discontinuous regime can be even lower than that of a continuous low-level regime. In fact, not the applied conditioning regime, but the water quality does affect the minimum amount of oxidant needed. The higher initial free oxidant concentration, needed in the case of discontinuous chlorination, is necessary to compensate for the lower contact time to achieve the same treatment results. This does not mean that the yearly needed oxidant amount is higher with a higher associated quantity of halogenated by-products in the outlet. Due to mixing in the receiving water rapid decay occurs of any oxidant conditioning regime, of acute toxicity as well as of formation of halogenated by-products.

The effectiveness of a conditioning regime is a combination of the level of temporary acute toxicity and the availability and quantity of nutrients in the water and the deprivation of the filter rate of the filter feeding organisms, such as oysters and mussels (or bivalvia).

It is necessary that the region from the pump pit until the exchangers as well as the stagnant zones becomes temporarily acute toxic to prevent settlement in the water distribution piping and the conducts and to keep the heat exchangers clean. The shorter the periods chosen the higher the temporary acute toxicity must be for the same effect. Or the longer the contact time is, the lower the acute toxicity needed to achieve the same result.

All oxidative conditioning regimes have in common that they take advantage of the reduced food intake of filter feeding organisms like mussels and oysters under stress. All oxidative conditioning regimes have also in common that spat settlement and growth is mitigated by prevention of opening their shells for prolonged periods of time. If they are forced to close their shells – which is the natural fugitive capacity – the organisms switch to anaerobic metabolism and live on their food reserves. Depending on their condition and local water temperature they can survive such stress periods for many months. Spat as well as youngster however avoids these circumstances through a second fugitive behaviour by non-settling or detaches its byssus wires, which explains the potential failures of intermittent regimes in specific areas.

Favourable conditions for spat settlements and growth are present in eutrophicated waters found at specific coastal areas and some harbours and it is further accelerated by increased water temperatures within limits. For that reason all conditioning regimes have in common that chlorination is not necessary when the nutrients are scarce at low water temperatures (12 °C). However in specific areas its threshold is 10 °C due to the rich nutrient availability even at relative low temperatures.

All these circumstances determine the necessary free oxidant concentration measured before or direct behind the heat exchangers with the related chosen time intervals between the intermittent dosages.

Continuous and discontinuous conditioning regimes show different levels of chlorination. In most waters, if the prevention of settlement is done with a continuous low-level chlorination nearby the pump pit, a FO-level before the heat exchangers of 0.3 mg/l has to be maintained. It results in a level of 0.2 mg/l at the outlet, which can generally be expected in cooling water circuits with a time span of 15 minutes. However, in nutrient rich waters the biofouling is so severe that higher inlet and thus higher outlet concentrations become necessary and sporadically can reach levels of 0.7 mg/l FO at the outlet to preserve its efficacy.

Discontinuous low-level chlorination in case of an ideal plug flow cooling water system will need higher FO-levels up to 0.5 mg/l before the exchangers to reach the same result and will automatically result in higher temporary outlet FO-concentrations. Indissoluble, the production of halogenated hydrocarbons will be higher also during these temporarily elevated oxidant dosages. Low frequency shock dosages are rarely done, which is based on their low conditioning efficiency towards bivalvia. These organisms will fully use the offered long respiration periods to recover. In general, intermittent regimes applied in nutrient rich waters are only effective if applied as frequently repeated chlorine dosages to minimise the recuperation ability of bivalvia. If these non-dosage periods are reduced to a quarter of an hour it is called pulse-chlorination. The organisms will interpret this as a continuous chlorination regime, since the frequency gives period too short for mussels and oysters to recover after being exposed to short successive periods of oxidation. Time intervals between the oxidant dosing periods have a much larger influence on the behaviour of these organisms than the free oxidant concentration, as long as this concentration is high enough to produce an initial stress effect on bivalvia.

If the whole cooling system is not an ideal plug flow system, than even higher frequency dosage regimes called alternating pulse chlorination (XI.3.3.2.2) can be successfully applied. It will make full advantage of the present reductants availability in a part of the cooling water that will mix just before the outlet system with previously chlorinated cooling water. Essential is that a

part of the oxidised cooling water will have a different residence time in the system and will reach at different times either as previously or future non-chlorinated cooling water, which still contains reductants. By shortening the dosage periods to an extend of three quarter of the residence time of the mechanical water system, an understoichiometric oxidant/reductant mixture is then created in the outlet zone. At the same time an overstoichiometric oxidant/reductant condition is created between the dosage point and the area where the different cooling water streams meet.

In summary, the (alternating) pulse conditioning regime reduces the annual use of additives and is particularly effective against macro-fouling. However, it may produce peak free oxidant concentrations at the outlet of the cooling system, which do not meet permissible release levels.

XI.3.3.2.2 Pulse alternating chlorination in once-through systems

[tm153, Paping et al, 1999], [tm168, De Potter et al, 1996], [tm169, De Potter et al, 1997], [tm170, De Potter and Polman, 1999], [tm171, Polman, 2000]

Description:

For an existing once-through system using seawater with flows up to 11 m³/s, a number of measures was developed and applied as part of an integrated system (“total care system”). The system comprises of 200 heat exchangers (mostly copper/nickel 90/10 and coated carbon steel) connected by 4 km of main conduits. Failure of the system as a result of damaged tubes was predominantly due to erosion corrosion failure (65%). The measures reduced the number of leakage incidents and at the same time the amount of biocide applied could be reduced. In the underlying situation hypochlorite had been dosed as antifouling treatment. As a result of long term experience it was considered to be the most adequate biocide for this system and for the available cooling water quality. Thus, no alternative biocide was being considered as a solution.

Optimisation was achieved by applying different levels of biocide treatment. The environmental impact of different regimes was evaluated by measuring and comparing the amount of chlorination by-products (predominantly bromoform) and the potential toxicity formed. The effectiveness was evaluated by looking at:

- the incidence of leakage of heat exchanger tubes caused by mussels,
- the amount of biological growth (macrofouling attachment)
- the behaviour of the valve movement of oysters.

Accordingly, the conditioning regimes were improved. It is important to realize that in this case use is made of knowledge about the local biotope. This is essential to reach the required accuracy of the treatment and the associated results.

Reduction:

The results of the optimisation show that an initial increase of hypochlorite (dosage A) did not reduce the leakage incidents in the first place, but was able to remove almost completely the macrofouling from the system as was observed from the mussel monitors. Once the cooling system was clean, reduced levels of hypochlorite (dosage B and C) were applied in the following years removing the macrofouling completely as well as reducing the number of leakages down to zero. The methodology applied is able to maintain the required level of FO at the right place. It is based on knowledge of the life cycle of macrofouling species, of microfouling areas in the system and of varying residence times and water velocities in different parts of the cooling system.

By maintaining low oxidant concentrations during longer periods the settlement and growth of bivalves in the distribution conduits can be prevented. Short term alternating dosage near the heat exchangers leads to temporarily high concentrations and is able to control microfouling. Over-stoichiometric dosage is applied in the influent at areas where water velocity rapidly decreases forming stagnant zones. The results are summarised in the following table.

Table XI.3: Effect of applying an optimized dosage regime on the number of leakage caused by mussels
[tm153, Paping et al, 1999]

Period	Regime	Number of leakages caused by mussels		Hypochlorite (metric tonne/year)
		Unit 1	Unit 2	
Year 1	A	28	4	1222
Year 2	A	28	12	2095
Year 3	A+B	32	10	2817
Year 4	B	16	1	2480
Year 5	C	0	2	1994
Year 6	C	0	0	2013
Year 7	C + freq.	1	0	1805
Year 8	C + freq.	0	0	1330

C + freq. = regime C with higher frequency (i.e. 5 minutes dosage per 20 minutes interval)

An even more targeted dosage regime is the pulse alternating chlorination that takes account of the variation in residence times in different parts of the process (Figure X.1.). At different times and at different points the required levels of chlorine are dosed following the flow patterns of the cooling water stream in the different process parts. At the end of the process and before discharge of the cooling water stream, dilution occurs by the mixing of the different process stream. Where only one of the stream is chlorinated and the other is not, the FO is further reduced and emission levels of < 0.1 mg/l are achievable.

Cross-media effect:

Considerable lower frequency of heat exchanger failure reduced necessary maintenance and consequently non-production periods. Cleaner heat exchanger increased cooling and reduced emissions from production process.

Application limits:

The conditioning regime cannot be applied to once-through systems without varying cooling water residence times.

The optimisation of dosage intervals the system needs careful monitoring of the free oxidant levels in the cooling system and of required stress periods of the bivalves.

Costs:

Research costs amounted to EUR 1 million during first 5 years. The first dosage installation was EUR 0.2 million, and further modifications again EUR were 0.2 million. The pay back period of the dosage installation was in the order of one year and based on the following costs:

- reduced cost level for yearly maintenance and use of sodiumhypochlorite,
- increased costs for yearly preventive and predictive maintenance, and
- costs for analyses.

Costs did not include research cost since these costs were spend to obtain the fundamental knowledge of pulse alternating chlorination in once-through systems.

Reference plant:

Dow Europe, Terneuzen (NL)

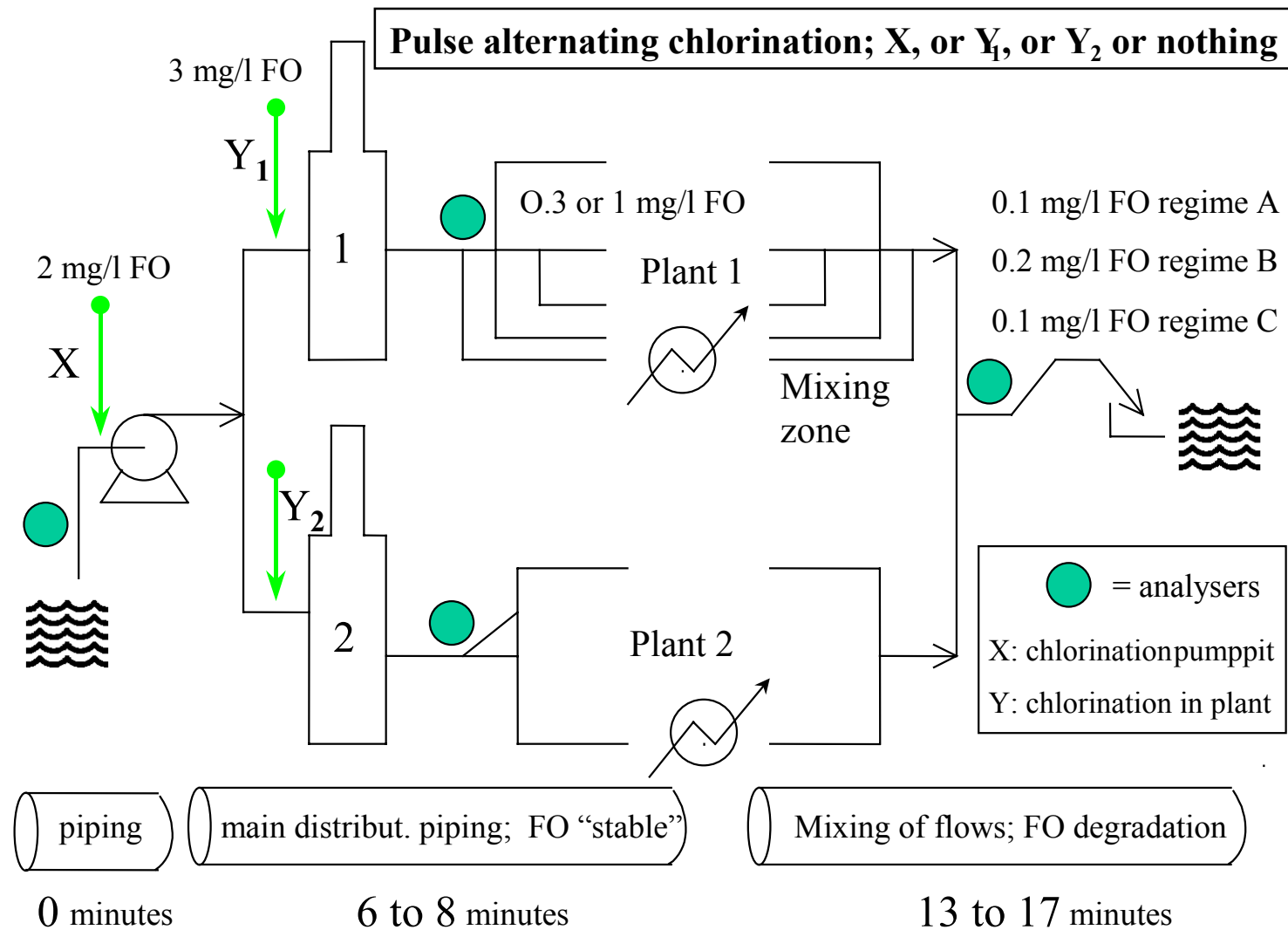

Figure XI.1: Optimised hypochlorite dosage (pulse-alternating chlorination) taking account of fouling and cooling system characteristics
Derived from [153, Paping et al, 1999]

XI.3.4 Alternative cooling water treatments

In this document the alternative cooling water treatment techniques consist of non-chemical methods as well as alternative chemicals or combinations of chemicals. It has already been illustrated how proper monitoring can lead to a more effective dosage regime reducing the amount of additive required and simultaneously maintaining a low incidence of system's failure.

XI.3.4.1 Ozone

[tm032, Zimmermann and Hamers, 1996], [039, Strittmatter et.al., 1996], [tm084Rice and Wilkes, 1992], [tm096, Mc Coy et al. 1990], [131, Dziobek, 1998] and [tm156, Schmittecker, 1999]

Description:

Extensive experience has been obtained with ozone treatment of drinking water. In Germany and the United States varying experiences have been obtained with ozone applied to recirculating cooling system. Ozone is a strong oxidant, more so than chlorine dioxide, which in turn is a stronger oxidant than sodium hypochlorite. Being very reactive ozone reacts with practically all organic material present in the cooling water and the residual effect is low if not absent. Also, ozone has considerable potential to destroy other cooling water additives, e.g. some corrosion inhibitors.

The reactivity of ozone depends on the pH of the water. When ozone is added to cooling water with a pH value higher than 8 - which can be often encountered in recirculating cooling system - it decomposes to form free hydroxyl radicals, which are stronger oxidising agents than molecular chlorine, but of microsecond half-life. In case that bromide ions are present in natural surface waters they will react with ozone to produce hypobromous acid, which is what is actually measured as residual ozone rather than ozone itself. Another important factor is the hardness of the water and it has been recommended to keep this between 100 and 400 ppm CaCO₃ and the chlorides below 200 ppm Cl⁻.

Reduction:

The reduction of microfouling, measured in microbiological activity, is variable and can be compared with a chlorine/bromine treatment. Reduction of up to 90% of the initial activity was measured resulting in concentrations of 20-50 colonies per ml. [tm156, Schmittecker, 1999]. Not only the amount, but also the character of the microbiology showed a change as a result of ozone treatment. A reduced number of colonies forming species could be detected in comparison with no treatment.

The concentration of ozone present in a system showed no direct influence on corrosion or scaling rate, although it was also concluded that mild steel and yellow metals corrode easily when ozone concentrations are too high (1.0 ppm). With the appropriate ozone-concentration those materials will initially corrode and form a corrosion layer. This layer will protect against increased corrosion, particularly pit corrosion. In the example, steel (C 1010) corrosion was reduced with 50% to 0.05 mm/year and brass (CuZn28Sn1) corrosion was reduced to less than 0.004 mm/yr.

Reduction of about 50% of AOX- and COD-levels in the effluent has been reported on different occasions due to ozone treatment. The resulting levels were less than 0.01 mg/l (AOX) and 10 mg/l (COD) respectively. The COD level was reached in the presence of a dosed hardness stabilizer.

Cross-media effect:

Although the formation energy of ozone is high, the application of ozone is often referred to as more environmentally acceptable than hypochlorite, since it leads to less formation of trihalomethanes (THMs) and extractable organic halogens (EOX). Ozonation may lead to the formation of by-products e.g. bromate and bromohydrins, but compared to chlorination by-product formation, relatively little attention has been paid to by-product formation resulting from ozonation.

As far as was reported, ozone emission into the air has not been observed from any part of the cooling systems.

Applicability:

Ozone is predominantly applied in the chemical and petrochemical industry and in refineries and to a limited extent in power industry, but from recent experiences wider application can be expected for smaller industries. The advantages are:

- Efficiency,
- low concentration of by-products,
- low stability of ozone with low or no ozone in the discharge as a result,
- reduction of COD and AOX.

In the U.S, it was concluded that ozone is not a “total” package for cooling water treatment covering all purposes, but does represent an alternative for a limited number of users. Furthermore, it is only useful as a stand-alone treatment in cooling water systems, which require no supplemental corrosion or scale control. Its reactivity limits the application of other biocides that would be destroyed immediately and if any biofouling occurs beyond the radius of ozone activity, it may not be dealt with.

Ozone is preferably to be used in very clean recirculating cooling system, and it is commented that its high reactivity makes ozone unsuitable for application in once-through system or long line systems. The speed with which ozone can disappear from a system is illustrated by the example, in which after the first application of ozone in a contaminated system the ozone concentration was reported to decrease below the detection limit within 50 meters from the point of dosage. For conditioning of a cooling tower of power plants a minimum concentration of 50 µg/l in the cooling basin is currently suggested, but positive results have been reported also with lower levels. It is considered best practice to apply ozone continuously at low level.

Costs:

Ozone production requires a considerable amount of energy and is relatively expensive due to the fact that the efficiency of the ozone generators is very low (100 g to 150 g O₃/1000 g O₂, 10 kWh/ kg O₃). Observations on costs may however differ as they depend on the alternative treatments available. For instance, observations were made that the ozone treatment can be compared to that of treatment with chlorine gas and that other chlorine or bromine based treatments could contain additional costs. Care must be taken when interpreting costs, where investment costs of equipment may or may not have been included and reference is made only to operating cost.

Reference plants:

Hoechst (Germany), power station Seraing (Belgium), power station EZH-Rotterdam Capelle (Holland) [see references]

Considerations:

A minimum concentration in the aquatic-environment of the cooling system is required to obtain the required biocidal effect of ozone. Recent work shows that to overcome the contamination already present, the initial dose may have to be between 0.1 and 0.3 mg/l and depending on the systems' environment it may take months before any residual ozone can be measured in the residual effluent [tm131, Dziobek, 1998]. It is claimed that in 60% of the applications ozone treatment can be reduced to 50% within 9 to 12 months with the surfaces being clean. This type of treatment resulted in a residual ozone concentration in the cooling tower basin of 0.05 mg/l. It was further reported that cleaner cooling tower fill led to an increased number of cycles and to a corresponding 70% decrease in water losses.

The point of dosage is very important in order to maintain the required ozone concentration in the right area of the cooling system. To avoid the breakdown of ozone, sensitive inhibitors and other cooling water treatment chemicals, side-stream treatment of the make-up was suggested. Ozone could also be applied in the cooling tower itself [tm131, Dziobek, 1998].

Ozone can be generated on-site by subjecting dry air or oxygen to an electric discharge. After this the product needs to be absorbed in the cooling water. According to the American Congress of Industrial Hygienists, 0.1 mg/l is the recommended maximum concentration for continuous exposure [tm059, Swinnen, 1995]. Ozone is very volatile compared with other oxidising biocides. [tm096, Mc Coy et al. 1990] investigated the volatility of various biocides in cooling towers. From this study the following order of volatility appeared: ozone > chlorine dioxide > chloramine > hypochlorous acid > hypobromous acid, with ozone being about 167000 times more volatile than hypobromous acid at 20°C.

XI.3.4.2 UV treatment

Description:

UV treatment of water to be used in recirculating cooling systems needs clear water for a start to give good transmission of UV irradiation and prefiltering of water might be necessary.

Reduction:

Particularly in summertime the treatment effected in reducing amoeba formation in the blowdown before discharge in the river.

Cross-media effect:

Energy costs were not reported.

Application limits:

It is mentioned that in sunny locations algae growth has been observed if no anti-algae was applied due to lack of residual effectiveness. To overcome this an anti algae will have to be added or the tower basin will have to be kept clean and free from sludge to prevent microorganisms to grow in the sludge. UV-lamps also need frequent cleaning.

Costs:

Not reported in full scale application.

Reference plant:

Hydro Power Station, Ontario, Canada, EDF Nuclear power Station, Poitiers, France (both experimental, 1999)

Considerations:

With the tendency to increase the re-use of water it is uncertain whether the required clearness of the water can still be reached in the future without considerable and expensive treatment..

XI.3.4.3 Catalytic hydrogen peroxide treatment

[comment, D]

Description:

The catalytic hydrogen peroxide treatment is a technique for decontaminating cooling water from the presence of microorganisms. The technology aims at meeting low limit values for levels of bacteria in the water. The system acts to prevent the formation of biofilms and algae and this in turn prevents the spread of bacteria, including legionellae colonies, through the systems. Hydrogen peroxide is used as an oxidizing agent, which in the instance of the metal catalyst generates a significant amount of •OH-radicals. These radicals have a very strong oxidizing effect, which is reported to be larger than that of e.g. ozone or chlorine.

The technology is reported to have a broad spectrum, which means that the radicals are effective against a large range of microorganisms including legionellae. Genetic resistance has not been reported and therefore shock dosing is not required. A relatively small concentration of H₂O₂ in the water is maintained and keeps the water practically bacteria free.

Reduction:

Catalytic hydrogen peroxide treatment will reduce the levels of AOX and COD. It is reported that it does not produce any residual hazardous chemicals in the discharge flow. It extends the operating period as it reduces the frequency of maintenance where the whole installation remains free from biofilms, algae and bacteriae.

Cross-media effect:

The catalyst treatment does not need any additional energy applied. The typical concentration of hydrogen peroxide (0.5 to 2 ppm) has shown no influence on the corrosion or scaling rate. Hydrogen peroxide acts as a corrosion inhibitor as well.

Application limits:

For each application the best option for installing the catalyst (in the form of light knitted wire mesh, normally on a stainless steel or PE mount) has to be selected individually. The catalyst may be placed on the bottom of the water basin or in the water distribution if an open system is used. A concentration of 30% of hydrogen peroxide solution was determined as very effective with respect to storage and application. It has been applied in cell type **cooling towers**. Limits with respect to the size of the cooling tower have not been reported. The data point at applications in small to medium capacity towers, but application for large capacity installations is under development.

Costs:

This treatment requires the investment for a metal catalyst. It is reported that with usual depreciation time for the catalyst of 4 to 5 years, the operation costs, including depreciation for the catalyst and the dosing system, are substantially lower than for either the application of a biocide (including hypochlorite) or the ozone treatment, when applied to the same cooling tower capacity.

Reference plant:

Ausimont Deutschland GmbH, Bitterfeld (D).

Considerations:

From experience two alternatives can be chosen as dosage point for the hydrogen peroxide: H_2O_2 can be applied in the common pump intake chamber of the cooling tower or direct into the rising pipes of each cell.

XI.3.4.4 Chlorine dioxide

Description:

Chlorine dioxide (ClO_2) has been considered as an alternative to hypochlorite ($HOCl$) for seawater conditions and as a freshwater biocide due to its effectiveness as a disinfectant and to its strong reduction in the formation of organohalogenated by-products in the effluent. It has been reported as an effective and economical application in cooling water systems for control of micro-organisms at relatively low dosages. It may be used over a broad pH range and is effective over the entire spectrum of micro-organisms. It has been reported to be effective particularly in systems with the following contaminants: ammonia and ammonia salts, alkanes, alkenes and alkynes, alcohols, primary amines, glycols, ethers, unsaturated aromatics, most inorganic acids, organic acids, diols, saturated aliphatics.

The conditions under which the application of chlorine dioxide is considered attractive are:

1. process contamination
2. alkaline pH systems
3. effluent chlorine discharge limitations
4. elimination of gaseous chlorine from the site.

The last advantage may be at question, where chlorine dioxide has been reported as difficult to transport and must be therefore produced on-site [tm059, Swinnen, 1995]

Chlorine dioxide does not react with water and is highly soluble in water. It has been found that blowing air through aqueous solutions of chlorine dioxide can cause chlorine dioxide to be expelled from the solution. Therefore solutions treated with chlorine dioxide should not be fed into areas of strong aeration such as splash tanks prior to going over a cooling tower. Aqueous solutions of chlorine dioxide are subject to photodecomposition upon long exposure to ultraviolet light. As with chlorination, treatment with chlorine dioxide could be scheduled during the hours of darkness to achieve greatest effectiveness.

On the treatment it was further observed that after initial high feeds of ClO_2 , shortly after the start-up, total plate count should normally decrease. After this initial period, ClO_2 begins to clean up the biomass accumulations of slime and entrapped debris. As the slime masses are attacked, micro-organisms break loose into the recirculating water. Consequently, the total plate counts, calcium and turbidity readings will increase for a period of time and then subside to normal levels. Moreover, foaming may also occur during this period.

Reduction:

Experiments in Italy were confirmed by observations in Spain for a large coastal power station with a **once-through system** [068, Ambrogi, 1997]. It appeared to be possible to lower the dosage of ClO_2 after an initial concentration of 0.22 mg/l. (8 kg/hour) during the growth season to about 0.18 mg/l. (6.5 kg/hour) and to reduce this even further in wintertime. These levels correspond well with other reported dosage levels. Dosage was continuous and effective in restricting mussel growth. The resulting concentrations of trihalomethane formations (THM) were considerably lower than in case HOCl was being used irrespective of reaction temperature or reaction time. They ranged from 0.31 $\mu\text{g/l}$ with a dose of 0.50 mg/l ClO_2 at 10 minutes and 15°C to 460.48 $\mu\text{g/l}$ with a dose of 0.40 mg/l at 60 min. and 60°C.

Considering the maximum initial dosage at 0.22 mg/l, needed to get an effective treatment, the expected concentration in the seawater at the end of the channel would be considerably lower than the LC_{50} (96 h.) of 54.7 $\mu\text{g/l}$. It has been proven that efficient antifouling of ClO_2 occurs at concentrations in the range 0.05 – 0.25 mg/l.

In open recirculating cooling water systems the typical dosage is 1-5 ppm chlorine based on the estimated volume plus make-up during feed to the entire system. Typically at start-up, chlorine dioxide is fed to a clean system at about 1 ppm for one hour, three times per day. Contaminated or dirty systems may require increased doses (3-5 ppm) and feed times. Mechanical cleanup of systems may be required to further optimise the programme.

It was recommended for systems where process contamination is suspected, to run a chlorine dioxide demand on the system. From the determined demand value the initial dosage can be derived, which from experience shows to be 30-50% of the demand value may be used for the initial dosage.

Table XI.4: Typical dosage of chlorine dioxide for once-through and recirculating systems in Europe

[CEFIC Sodium hypochlorite group, comment]

Cooling system	Mode of application	Time of application	Typical dose (mg/l)
Once-through system	continuous	8 hours a day/ during 8 months a year	0.4
Recirculating system	discontinuous	6 times for 1 hour/day	0.3
	continuous	all year round	0.2 in winter 0.5 in summer

Table XI.5: Effect of chlorine dioxide applied in once-through system on larvae settlement [U.S. data, Van Hoorn, comment]

Dose	Frequency	Settlement-reduction
0.25 mg/l	4 x 15 min/d	95%
0.25 mg/l	2 x 30 min/d	35%

Cross-media effect:

Although it does not form any THM or chlorophenols it is expected to find reaction products like aldehydes, ketones and quinones or even epoxydes under certain circumstances. The latter are known to be carcinogenic or mutagenous.

Application:

Treatment with chlorine dioxide requires an installation for in situ production. Due to its sensitivity for pressure and temperature the gas cannot be compressed and transported in cylinders. Three ways of in situ generation are mentioned by [tm059, Swinnen, 1995]:

1. from sodiumchlorite/chlorous gas
2. from sodiumchlorite/sodiumhypochlorite/(chlorine acid)
3. from acid activation or sodiumchlorite by means of chlorine acid

Feeding point

To obtain the best results, chlorine dioxide should be fed directly into the recirculating water of a **cooling tower**, at a point of good mixing, such as below the water line in the cold well or just ahead of the equipment that is most critical. A side-stream of chlorine dioxide can be fed to the basin at the far end (opposite cold well) to create a "sweep" effect across the basin or into the return riser for additional control within the tower.

Monitoring

When chlorine dioxide is used as a microbiocide in cooling water it is important to monitor the amount used and its effectiveness. Close control of chlorine dioxide residuals with attention to plate counts provides the best results at the most economical cost.

At times a free chlorine dioxide residual can be found in the return water of a recirculating loop or the effluent of a once-through system. The free residual is less than 0.5 ppm in most cases as tested by the Chlorophenol Red method. In systems where no free chlorine dioxide residual is found, visual observation of the biomass, through biological organism counts or differential pressure measurement can judge results.

In the U.S., Redox control is most often used as on-line monitoring technique. Typical ORP values for good control are reported to be 350 – 500mV.

Costs:

Costs have not reported, but it was concluded that further research was needed on application strategy to reduce the amount needed in **once-through cooling systems** and thus lower the price. At the moment of investigation it was considered too high for full scale operation (1996).

Reference plant:

Brindisi Nord power station, Italy (experiment).

Considerations:

With respect to the application in **once-through systems**, a comparison with chlorination would need to normalize dosage regimes to be able to consider the features of both chlorine dioxide and chlorination as a biocide and in the discharge. Further research seems necessary based on the above-mentioned promising results.

XI.3.4.5 Ionic water purification to treat cooling tower water

[tm036, Wilsey, 1997]

Description:

Based on an already existing concept of supplemental ionic water purification is an alternative method to treat cooling tower water with copper ions. It is claimed that a chemical-only water treatment system can be replaced by this technique leading to less harmful substances being more economical to the environment.

Reduction:

Microbiologists are quoted that have determined that small amounts of copper acting as supplement to chlorine at 0.4 ppm have the same efficiency as 2.0 ppm free chlorine.

Cross-media effect:

Costs have not been reported, but could be energy input for copper ion generator.

Application limits:

To apply this treatment a copper ion generator is needed together with a device to control total dissolved solids, a magnetic water conditioning system and a system to analyse the water composition. With these systems the treatment can be optimised.

A number of factors have to be taken into account. The composition of the make-up water has to be such that the tower sump contains an alkalinity level between 40 ppm and 130 ppm and the pH between 7 and 8. The effects of copper are that it functions as a coagulant to reduce scale, forming larger complexes to be separated and filtered more easily. It also acts as a bacterial disinfectant forming copper compounds that are lethal to bacteria and algae. Finally it has a function as algacide to blue-green algae in particular.

Attention should be given however to the amount of cycled copper that will also dictate the concentration in the purge or blowdown. Also the residual concentration of the lethal copper compounds need further examination as the discharge to the receiving water could cause harmful effects.

Costs:

Not reported

Reference plant:

Not reported.

Considerations:

Results will have to be proven yet in full scale application.

XI.3.4.6 Stabilizing halogenated biocides in cooling tower water

[tm62, Dallmier et.al, 1997]

Description:

Particularly chlorine and bromine based products are often applied. As the biocidal effect of a halogenated biocide depends on the total halogen residual and it is important to prevent any reactions that can decrease the amount of residual in the cooling water. Reactions with other corrosion and scale inhibitors can occur (e.g Br with tolyltriazole). Halogens can be stabilised to reduce halogen volatility and to increase compatability with inhibitors and to maintain sufficient effective halogen. Stabilising of bromine was achieved with the application of hydantoines. On the stabilising process no further information is reported.

Reduction:

Application of stabilised bromine in cooling towers revealed the following effects:

1. the loss of Br due to volatilization is less when Br is stabilised thus leaving more free Br present in the cooling water;
2. stabilised Br appeared to be one third faster in killing slime-forming bacteria than unstabilised Br;
3. stabilised Br appeared to be very effective in removing mixed culture biofilm, the removal of 45% of the biofilm was measured to create a 47% reduction of the pressure across the tube;
4. application in an office chiller system showed effective against *Legionella pneumophila*;
5. more than 95% of the yellow metal corrosion inhibitor tolyltriazole was maintained in the cooling water when stabilised Br was added.

Cross-media effect:

No information was available on the effects of the application of an additional chemical to stabilise the halogen.

Application limits:

It has been applied in recirculating systems (wet cooling towers). Comments on the applicability of this technique concerned the application of hydantoines. It was reported that handling of hydantoines (in pellet form) is difficult requiring dissolving devices. This limited the application to small size cooling systems. Currently a liquid stabilised bromine product is on the market, which can be applied in large size systems as well.

Costs:

Costs of the stabilizing have not been reported.

Reference plant:

On the stabilized liquid product 2 refineries (in Germany and Austria) and 1 chemical plant in Germany were reported.

Considerations:

Above-mentioned effects were confirmed by the results of field experiments. Two remarks have to be made. On the addition of stabiliser and its behaviour in the cooling system or the purge no observations were reported. The hazardousness or environmental acceptability could not be established.

Its working on *Legionella* was tested in a chiller system, but a translation to conditions in cooling tower systems has not been made.

XI.3.4.7 Filming agent against fouling, corrosion and scaling

Description:

Filming agents are applied that cover the surface of conduits on the waterside to prevent or reduce fouling and corrosion or scaling and do not treat the cooling water flow. A commercially available compound, called Mexel[®]432/0, is applied primarily constituting of long chain aliphatic amines. In aqueous emulsions, this product forms a film on the cell membranes causing destruction of tissues in a varying proportion depending on the dosage. The efficiency of this technological alternative is not linked to the modification of the water chemistry properties nor the water biology of the cooling circuit, but rather to the adsorption or integration of Mexel[®] onto all the surfaces present in the circuit. The anti-fouling effect can be explained by the integration of the Mexel constituents into the biological membranes, and into the biofilm. This integration disturbs the cohesion of the biological structure and at high concentrations results in the destruction of the membranes. At sublethal concentrations, the constituents of the Mexel insert themselves into the membranes and disrupt the ionic or gaseous transfer of the membranes. In this case, the treatment produces a state of stress for the animal (mussels, etc) sufficient to avoid their definitive installation in the circuit treated.

It has a broad spectrum of action on microfouling and macrofouling in both seawater and freshwater. The product has also anti corrosion and anti-scaling properties and the treatment procedure is generally intermittent, intended to renew the film on the surfaces to be protected. Suggestions were made that periodic treatments can be more effective on macrofouling. The film lasts for 10-20 days.

Dosage is done automatically and starts with an initial dosage to establish the film. Concentration in the discharge is measured and dosage levels are reduced as soon as Mexel 432 can be detected in the discharge. The initial period for a large seawater once-through system is about 10 days.

In once-through systems, the analysis of the product is performed either by a spectrophotometric laboratory method or by a colourimetric field analysis method. This second analysis method allows a rapid control of product concentration at various points in the circuit.

Results:

The treatment conditions, defined by the concentration to be injected as well as the duration of the injections, are dependant upon the results researched (bio-fouling, corrosion, fouling or scale), the physico-chemical properties of the water medium and the circuit characteristics (type, temperatures, surface condition, materials, flow rates, etc).

It can be effective against bivalves on a periodic treatment basis and at a residual concentration of 3.5 mg/l. The efficacy of long-term intermittent treatments on zebra mussels has also been shown in experiments: a dosage of 3 hours per day at 6 mg/l kills 100% of zebra mussels.

At the example plant, for corrosion protection of aluminium brass a dosage of 5 ppm for 30 min. per day was sufficient. For macrofouling a dose was applied of 0.5 ppm at 5 hrs/day. By way of bio-monitoring reactions of mussels on the dosage were researched to identify an optimised treatment regime.

Cross-media effect:

On the visited site there was clearly an advantage as no electrolysis of seawater was anymore needed. This also ended the maintenance of the electrolyser, which is costly, both in terms of environment (human health) and finance.

Three processes are involved in the disappearance of Mexel in solution: immediate demand, turbulence of the water, and bacterial degradation in aerobic conditions. Bacteria showed degradation of up to 98% of the product in 10 days.

Regarding the toxic effects of the product on freshwater organisms, it showed rapid disappearance in natural waters of the product in its toxic form, and absence of detectable toxicity during its degradation.

Application limits:

Application is independent of the metal tested, (bronze, copper nickel alloys, iron and stainless steel 304L & 316L) or the water medium (fresh or seawater), Mexel can be an effective chemical or biological corrosion inhibitor.

It allows the treatment of open or semi-closed recirculating hydraulic systems which have flow rates ranging from a few cubic meters per hour (air conditioning systems) to 100.000 m³hr⁻¹ in fresh water, brackish or sea water. On a world-wide basis, the product is used to treat the hydraulic systems (cooling, fire fighting, etc) of electrical power plants, geothermal installations, shipping, the chemical industry, steel mills, refineries, off-shore platforms, and air conditioning units using water as the thermal fluid.

Costs:

Cost data have only been given in comparison with the application of chlorination and particularly in comparison with electrolysis. Confirmation could not be obtained on the cost balance of Mexel compared to chlorination. Costs depend on the surface to be treated and not on the cooling water volume.

Reference plant:

EDF Power Station, Le Havre (F).

Considerations:

Environmentally its low toxicity and the absence of any detectable toxic degradation products make it acceptable as an alternative to cooling water treatment.

As the product is easily biodegradable, this advantage may be a disadvantage when it comes to the amount needed for initial treatment of the surface. Its reactivity may raise the amount needed and the costs involved. Where fresh water generally has higher dissolved solid contents than seawater this could indicate a preferred application in seawater conditions.

XI.3.4.8 Stable organic corrosion inhibitors in open wet cooling towers

[tm091, CTI, Little et. al]

Description:

Organically based treatment used in an open wet cooling tower can be counteracted because of their susceptibility to strong oxidising agents, their sensitivity to high heat flux conditions, their tendency to precipitate as calcium salts at high hardness levels, and the need for constant water flows. To overcome these problems Ethanolamine Bisphosphono-methyl, N-oxide (EBO) was developed. EBO is an organic phosphonate that can be used in cooling water treatment as an anodic corrosion inhibitor. EBO is reported to exhibit good stability against halogens. Its stability at calcium levels of 500 mg/l calcium as CaCO₃, buffered at a pH of 8.3 and a temperature of 60°C, was compared with HEDP.

Reduction:

It was found that over 100 mg/l of EBO could be added without precipitation, whereas this was only 7 mg/l of HEDP under the same conditions. No adverse effects on yellow metal corrosion could be indicated. Corrosion was considerably reduced compared with an organic treatment without EBO.

Cross-media effect:

Lower water requirements occur due to potential option for higher cycles of concentration, as EBO is less sensitive to high calcium hardness levels.

Application limits:

Only applied in open recirculating system.

Costs:

Not reported.

Reference plant:

Pilot cooling tower, no full-scale application reported.

Considerations:

Application of EBO and similar cooling water treatment chemicals with improved working need further research of the levels of toxicity in the discharge respectively blowdown of the systems they have been applied to.

XI.3.5 Treatment of discharged cooling water

Minimisation of emissions from an integrated approach starts with minimisation of resources used. As such Chapter 1 presents the initial approach that should be taken. Within the limitations of cooling system and site-specifications a certain amount of chemicals might still have to be applied with a certain discharge as a consequence. Monitoring and optimised treatment are able to reduce the discharge further.

In some cases before discharging cooling water streams are treated in wastewater treatment facilities. For information on wastewater treatment reference is made to the concerning BREF. Particular examples of cooling water treatment have not been reported. With respect to treatment a few remarks can be made:

- blowdown treatment containing peak concentrations after dosage can be collected in a buffer basin to prevent the aquatic-environment or the water treatment facilities to be affected. In the basin further hydrolysis of the biocides can take place down to less toxic substances before the water is discharged or reused.
- Because of concentration of process substances, the blowdown of closed recirculating systems of refineries may have to be treated before it is sent to a wastewater treatment plant to avoid affecting the equilibrium of the treatment plant. It is maintained that the oil level of this blowdown generally is much lower than the residual oil level in pre-treated process water of other installations and therefore can be led to the waste water treatment plant without pretreatment.

XI.4 Variable frequency drives for reduction of energy use

[tm097, Immell, 1996]

In operating a cooling system the required direct energy input can be reduced by reducing the need for pumping capacity and by optimising the use of fans. In a greenfield situation many can be done on the design (e.g. cooling tower construction, type of fill, pump configuration), but in an existing installation options are more limited and comprise of changes of equipment.

Description:

The application of variable fan speed drives is an option to adapt the fan speeds specifically to the required cooling duty. One technique is the use of variable frequency drives (VFD). A VFD is a combination of a converter of the voltage and an inverter of the current (DC to AC).

Cooling towers are typically designed to provide a specified cold water leaving the tower for a specified heat load at a certain wet bulb temperature, that is only exceeded at minimum percentage of the year (1-2.5%). Most of the time they will perform at a lower wet bulb temperature than the design, but on a variable level based on seasonal variation of wet bulb temperatures.

With the VFD system this variation is translated into different fan speeds to obtain the required water temperature. VFD are commercially available from different suppliers.

Reduction:

Reduction in energy use as well as in reduced noise levels and reduced vibration due to slower operating speeds is achieved. Also, higher longevity of rotating equipment due to smoother speed change of the motor (so called soft start) was observed.

Cross-media effect:

See section on reduction.

Application limits:

To apply a VFD a number of specifiable features to be checked were mentioned, such as: an automatic temperature control, the proper layout of the VFD to the demands of cooling tower fan motor, and an analysis of resonance of the equipment.

Costs:

A cost indication was not given

Example plant:

Not mentioned with respect to experiences with application.

ANNEX XII SPECIAL APPLICATION: POWER INDUSTRY

[tm132, Eurelectric, 1998]

Synthesis

In order to synthesise the specific knowledge and enable other industries to benefit from it, this Annex has been drawn up within EURELECTRIC. It is the outcome of collaboration mainly between ELECTRICITÉ DE FRANCE, ELECTRABEL, LABORELEC and VDEW resp. VGB representing German Power Plant Operators. The results of the permanent various working groups of UNIPEDE¹⁹ and CORECH²⁰ have also been included.

The Annex is meant to give some background information for a better understanding of the information presented in the main document. It explains in a simplified way the operation of thermal power plants. It sets out the main functions of the cooling systems of the condenser and auxiliaries. The possible environmental impacts of cooling systems are then examined in more detail. This part of the Annex particularly concerns heat discharges, the suction of living organisms into water intakes, any discharges of treatment reagents and other potential detrimental effects, such as noise.

Also, an analysis of the various cooling techniques conceivable is made. It is referred mainly to the design of a new system and to be used as additional information for the determination of BAT. It deals with not only the technical and economic aspects, but also and especially with the ecological and energy impact of the various solutions. Its conclusions, although specifically aimed at the power industry, fall within the general BAT conclusions of Chapter 4 of the main document.

The main conclusions that have emerged from the analysis are:

- The impact of a cooling system on the receiving environment must be studied before the power plant is designed; to do so, numerical modelling and on-site tests in pilot loops are recommended;
- The design of the cooling systems must be studied while taking into account the ecological and energy impact to a maximum;
- The implementation of physical processes intended to limit fouling must be sought systematically (continuous mechanical cleaning, temperature increase, filtration, etc.);
- Chemical solutions must be studied on a case-by-case basis so as to limit their utilisation to the utmost;
- One best solution cannot be selected as too many local factors influence the choice of the cooling system of a power plant. They include not only the flow-rates available, but also visual aspects.

XII.1 Introduction

The thermodynamic cycle of conventional thermal power plants obeys CARNOT's principle. Efficiency levels reach about 40% for conventional new design but can achieve 47% in advanced design and under very favourable climatic conditions in particular when cooling water conditions are suitable (once-through cooling system), even with hard coal firing. The result is that nearly 45% of the amount of energy provided by combustion must be dissipated at the condenser level.

The condenser is the key point of the facility. Regardless of the mode of cooling adopted, it is in fact one of the main interfaces between the power plant and the surrounding environment. The

¹⁹ The International Union of Producers and Distributors of Electrical Energy.

²⁰ Committee on Research.

efficiency and availability of a power plant depend to a great extent on the integrity and cleanness of the condenser. These are reasons why specific solutions have been adopted for a long time now: continuous mechanical cleaning by foam balls, corrosion-resistant alloys, such as titanium and stainless steel, etc. Also cooling water treatment systems have been developed and are in operation, in particular for circulating cooling systems.

Likewise, as cooling flowrates may reach several dozen m^3/s , the modes of treatment adopted and solutions selected may be difficult to extrapolate to other industries.

XII.2 Power plant cooling systems - principles and reminders

The operation of power plants is governed by CARNOT's principle. The heat source, the boiler, provides the energy required for water vaporisation. The cold source, the condenser, condenses the steam coming out of the low-pressure turbine.

One of the main characteristics of a power plant, from the technical and economic standpoints, is its **specific consumption**, in other words, the amount of heat needed to produce one kWh of electrical energy. This specific consumption results from the thermal cycle balance (table 1).

Table XII.1: Example of simplified balance of a thermal cycle for conventional new design

Energy transformation	Energy (kJ)	(%)	Efficiency (%)
Energy from combustion	9000	100	100
Steam generator loss	1050	- 11.7	88.3
Condenser "loss"	4200	- 46.5	41.8
Feedwater heating	(2000)	(22.2)	(Looping)
Turbogenerator losses	65	- 0.75	41.05
Power supply of auxiliaries	65	- 0.75	40.3
Loss in main transformer	25	- 0.2	40.1
Overall efficiency of the facility			40.1

The presence of the cold source is the main consideration. Not always can cooling systems use water drawn directly from a river, sea or lake. It may be necessary to use a recirculating system with a cooling tower. A look at the thermal cycle balance shows that 4200 kJ must be yielded for each kWh generated. In addition, this energy cannot be recovered because its exergy is low.

New generation systems, especially combined cycles (or gas-steam turbines), make it possible to obtain higher efficiencies of even more than 55%.

The cooling system, which serves to evacuate this energy, is generally called the circulating system. The condenser tube bundle contains cold water drawn from a river, the sea or a lake. The heating and flowrate of this water depend on the installed capacity (table 2).

Table XII.2: Relationship between the installed capacity and cooling parameters

(Values as an example, depending on type of the circulating system, the ambient air temperature, cooling water resource temperature)

Rated capacity of the unit (MW)	Circulating water flowrate (m^3/s)	Heating of water in the condenser (K)
125	3 – 5	7 – 12
250	6 – 10	7 – 12
600	14 – 24	7 – 12

Each unit also has an auxiliary cooling water system:

- generator seal oil coolers,
- compressor coolers;
- etc.

Closed-loop cooling systems, supplied with demineralised water, are systems for:

- generator stator cooling water coolers;
- generator hydrogen coolers;
- etc.

Depending on the units, the cooling water flowrate of this cooling system of the **auxiliaries** represents normally about 4 to 8% of the circulating water flowrate. Heating is limited and amounts up to 10 K, according to the auxiliaries in operation. However, even with a low thermal load, it can remain in service several days after the shut down of the unit to evacuate the residual heat.

XII.3 Possible environmental impacts of cooling systems

The heat releases at the cold source mainly concern two receiving environments: air and water. But, in fact, even if the discharge occurs into an aquatic-environment, the ultimate heat sink remains the atmosphere. Indeed, the water gradually transfers the heat received by various natural processes: evaporation, conduction, radiation. For economic reasons, water is the first area where one looks.

Before wondering what techniques may be acknowledged as BAT for cooling systems, it seems desirable to make an analysis of any detrimental effects on the natural environment, estimate their nature and amplitude and judge them, in other words decide whether they remain tolerable or not.

XII.3.1 Heat discharges to the atmosphere

Regardless of the type of cooling system, all of the heat conveyed to the cold source is transferred to the atmosphere. This is carried out on a specific basis in the case of cooling towers, air-cooled condensers and dry cooling towers. In the case of once-through cooling systems on a river, lake or the sea, the heat is transferred via the surface of the receiving water body, over a large area and with a certain time lag, depending on the local situation.

In power plants cooled by a **once-through system** (Figure XII.1, Section XII.11), pumped water is generally heated from 7 to 12 K when the units operate at their rated capacity. The discharged cooling water is progressively cooled by mixing with the receiving water. The heat is then transferred to the atmosphere by three conventional processes: evaporation (35 to 45% of the energy released), by radiation of the water surface (25 to 35%) and by conduction with air (20 to 30%). Depending on the local situation the outlet temperature could be limited by the local authority.

Energy transfer by evaporation represents a vapour flowrate of 20 kg/s per 100 MW_{th}. Considering the rapid decrease of water heating process downstream of the discharge, the only atmospheric phenomena likely to be modified are occurrence frequencies and the persistence of evaporation fog in the area close to the release, where temperature differences are still considerable, but the extent of which is limited.

It is worthwhile noting that, all things considered equal, the temperature of the formation or disappearance of evaporation fog is higher above salt water than above soft water. This circumstance is therefore favourable to power plants sited in estuaries or along seacoasts.

For power plants equipped with **wet cooling towers** (Figure XII.2, Section XII.11), everything occurs as if the heat was released directly to the atmosphere. Two kinds of operation methods are in practice:

- once-through cooling with cooling tower (Figure XII.3, Sector XII.11) and
- recirculating cooling (Figure XII.4, Sector XII.11).

The discharge takes place in a concentrated way over a small area. Wet cooling towers transfer to the atmosphere about 70% of residual heat in the form of latent heat (wet vapour) and about 30% by sensitive heat. Thus, the vapour flowrate released to the atmosphere is roughly twice that resulting from once-through cooling without cooling tower. Air saturated with humidity is released to the atmosphere at a temperature of about 10-20 K above ambient temperature and at a velocity up to 3-5 m/s in the case of natural draught cooling towers. This velocity is doubled in the case of mechanical draught cooling towers. This air saturated with humidity, by cooling through turbulent mixing with ambient air, may give rise to the formation of artificial clouds or plumes.

The risks of fog formation on the ground resulting from the lowering of the condensation plume may be relatively frequent especially with mechanical draught cooling towers (Figure XII.5 XII.6 and XII.7, Section XII.11) due to their low height and in conditions of cold humid weather without wind. The relevant area is about 500 m from the emission source.

The frequency is considerably reduced, when the cooling towers get higher. In plains, one may estimate that the lowering of plumes reaching the ground is exceptional as of a height of 50 to 75 m depending on the local situation.

The formation of frost may result from the contact with the ground frozen either by the fog due to the lowering of the plume, or by precipitation linked to priming, or by sprays from the base of the cooling towers. However, the impact of such sprays remains confined to an area near the cooling tower and concerns at the very most the several dozen metres close to the base of the cooling tower.

The main climatic modification due to the operation of wet cooling towers concerns a local increase of nebulosity by the development of the condensation plume which results in the reduction of sunshine and light in the vicinity of the power plant.

For power plants equipped with **dry cooling towers** (Figure XII.11, Section XII.11) or **air-cooled condensers** (Figure XII.9 and 10, Section XII.11), the absolute humidity of the air is not changed, but its temperature is higher by about 15 to 20 K above the ambient temperature. All of the heat is released in sensitive form and the non-saturated hot air, which rises in the atmosphere, seldom leads to cloud formation.

Hybrid cooling towers (wet/dry) (Figure XII.8, Section XII.11) make it possible most of the time to avoid the formation of plumes. Water consumption (i.e. make up water) is 20% less than that of a wet cooling tower. However, at the present time, the only hybrid cooling towers available are of the mechanical draught type. The annual balance of a power plant with mechanical draught type hybrid cooling tower can be in the same range to that with a comparable mechanical draught wet cooling tower. This takes into account the operation mode.

Since a few years at fossil fired power stations the discharge of desulphurised flue gases via cooling tower is state of the art at least in Germany. It is an alternative to traditional discharge by stack and has ecological and economical advantages.

XII.3.2 Heating of receiving aquatic-environments

Although the final heat sink is the atmosphere, in most cases, a fairly large part of the discharge of a thermal power plant takes place in the aquatic-environment. Various physical phenomena come into play here:

- turbulent diffusion,
- convection in water,
- flow of fluids of variable density,
- evaporation, radiation, convection in the air.

Depending on the extent of the discharge and according to the receiving environment, such a phenomenon is preponderant and affects the way the heat is distributed in the receiving environment.

The near field of the cooling water discharge should be distinguished from the far field.

The **near field** is defined in a river as the area in which the mixing of the warm water plume with river water is incomplete.

The water temperature in the near field depends upon the mixing of water released by the power plant with the water of the receiving environment. Heating can be reduced in this area by rapidly mixing the effluent with the water of the receiving environment by means of specific devices.

The **far field** is the warm water geometry that is fully mixed with depth within the water column and is thus a background heat field. The excess temperature in the far field is gradually reduced due to the dilution with ambient waters and heat exchange with the atmosphere.

As concerns discharges in a **tidal sea or sea with strong currents**, the warm water plume formed by the discharge of the power plant is mainly governed by the existence of major velocities in the receiving environment. They bring about a rapid mixture of the water preventing any stratification caused by the difference in density between the warm water and cold water. The temperature drop in the warm water plume principally comes from the mixing and not from heat losses at the surface of the water area. The extent of the warm water plume in a tidal sea, defined as the area within the 1 K heating isotherm, covers an area from 2 to 10 km² for a discharge corresponding to that of a 5 000 MW_e nuclear power plant.

The behaviour of the warm water plume in a **tideless sea** is first of all that of a stratified flow. The temperature drops very quickly through dilution due to friction and turbulence. In a tideless sea (or lake) the spreading or transport of cooling waters is strongly influenced by wind-induced currents and thermocline conditions and is estimated as roughly 1 ha/MW_e.

Normally for coastal power plants the cooling water is discharged to the sea surface through an open discharge channel.

The behaviour of the warm water plume in an **estuary** is similar to that in a tidal sea with strong currents. The alternative movement of water plays an essential role. The river flow will tend to transport the heat towards the sea. The incoming tide will slow down or change the direction of flow, and will thus affect the spreading of the warm water plume in the estuary.

The assessment of the heating of a river subsequent to a warm water discharge is relatively complex. Indeed, the cooling mechanism of the river downstream mainly results from the exchange of energy between the river and the atmosphere. The energy flow between the stretch of water and the atmosphere fluctuates considerably depending on the meteorological conditions and the time of day.

In a river, diffusers distributed all along the width of a waterway serve to carry out the mixture over a distance of several dozen to several hundred metres. If the discharge is performed along the bank, complete mixing by natural flow is carried out over a few kilometres instead.

In all cases, **recirculation in the river must be avoided** or the recirculation rates for discharges into the sea and especially in the estuary reduced to a minimum to ensure efficiency and safe operation of power plants. The position and design of water intake and outlet structures are determined to eliminate the risk of recirculation.

Preliminary studies make it possible to design water intake and outlet structures and devices best adapted to avoid recirculation and favour the initial mixing of heated water discharges. They rely on physical models (hydraulic models) and numerical models. Where possible the numerical modelling etc. should be based on site-specific hydrographic survey data.

The use of these tools as part of the impact study of projected facilities serves to give assurance that regulatory thermal limitations will be respected, whether they concern maximum heating in the mixing area or the temperature level after the mixing.

XII.3.3 Suction of organisms into water intakes

When pumping the water needed for cooling, thermal power plants draw in microscopic organisms (algae and plankton), as well as organisms which swim in the open water (some crustacea and fish). The plankton passes through the rotating filters the mesh of which is generally between 1 mm and 5 mm. This does not hold true for crustacea and fish, which are flattened against the filtering panels, drawn up and discharged with the washing water of the filters.

Some studies have shown that most of the organisms drawn into the water intakes are small in size: Shrimps, larvae and alevin in the sea and estuary or alevin in rivers. The case of young salmon migrating downstream, which are particularly drawn into the water intakes, is specific for the behaviour.

To limit the entrainment of these species, three types of measures may be taken:

1. Place the intakes outside critical areas, such as spawning grounds and "fish nurseries" on the seaside, or migration routes for eel larvae in estuaries;
2. Design intake structures which minimise the drawing in of organisms;
3. Equip intakes with repulsive devices or equipment, which restore organisms to the environment without damage.

A lot of deterrent systems (repulsive devices) have been developed and installed at water intakes of hydropower and thermal power stations over the last decades:

- In freshwater bodies, electric fish screens can frighten away fish of specific stages, but do not affect fingerlings or even attract them into the intakes;
- Air bubble curtains generally had very bad results;
- Light is partly efficient on certain species, but fish can be acclimated and the deterrent effect is not constant;
- Some results with sound deterrent systems are promising, but there are contradictory results.

The investment costs depends on the size of the intake and the flowrate and can be roughly estimated to be in the range of Euro 40000 to 200000.

4. Equip intakes with recovery systems, which restore organisms to the aquatic-environment without damage.

In large water intakes with travelling screens, the organisms can be removed with a fish pump or washed out of the screen by low-pressure water jets (1 bar). At a power station on the

Gironde Estuary (France), such systems showed relatively good efficiencies with survival results of 80% to 100% for shrimps, plaices and eels. Other attempts have been less effective or very costly.

The first two actions, of a preventive nature, are preferable to curative actions the efficiency of which presently remains problematical. A universal, widely applicable, solution is not available.

XII.3.4 Alteration of the receiving environment by chemical discharges

The water withdrawn for cooling purposes may sometimes be the cause of chemical releases into the receiving environment. The following may be concerned in particular:

- reagents used to avoid the scaling of cooling systems equipped with cooling towers;
- reagents used to fight against biological developments, reaction products of some of them;
- iron sulphate anti-corrosion treatments to protect, in some cases, copper alloy condensers;
- corrosion products of heat exchangers and piping.

As concerns the **marine environment**, the purpose of the biocide treatment is to maintain the systems sufficiently clean so as to ensure their proper operation. For the sea intakes, the main problem is to avoid the development of molluscs (mussels, oysters, etc.) inside the cooling system. The current practice is the injection of chlorine. It is generally produced on-site by sea water electrolyses. This process avoids the risk involving the transport of NaOCl by truck. The chlorination can be made on continuous or discontinuous (seasonal) basis depending on many factors such as meteorological characteristics of the site, water quality, cooling circuit design and biofouling typology (settlement periods and growth rates).

Mainly the injection takes place in low doses so that the concentration in free chlorine in the discharge is generally between 0.1 and 0.5 mg/l normally (sporadically 0.7 mg/l). The value of this limit concentration is set by local regulations.

However, when it reacts with some organic matter, chlorine may lead to the formation of organo halogenated substances (mainly bromoform in seawater). Some studies nevertheless show that bromoform concentrations in the plumes of warm water discharges from coastal-sited power plants remain extremely low (about 15 µg/l).

It would be advisable here to compare this figure with the natural production of organohalogenated substances in the oceans. According to Grimvall and deLeer (1995), the annual production of a number of organohalogenes is:

- chloromethane : 5.000.000 t;
- bromomethane : 300.000 t;
- iodomethane : 300.000 t to 1.200.000 t;
- chloroform : 90.000 t to 360.000 t;
- bromoform : 500.000 t to 1.000.000 t;
- iodoform : not detectable in sea water.

The natural concentrations in AOX ranging from 6 to 17 µg Cl/g of sediment in the Gulf of Bothnia and from 50 to 180 µg Cl/g of sediment in the Gulf of Finland were measured. The presence of these organohalogenated molecules has been attributed to biohalogenation reactions.

Chlorination is the anti-fouling chemical treatment method that is the most commonly used to protect the systems of coastal-sited power plants. Another oxidant, chlorine dioxide, has nevertheless been tried with success on thermal power plants.

For a great many years, the choice of the alloy for the tubes of heat exchangers in coastal-sited power plants has gone towards titanium. Under these conditions, the contribution of corrosion products is insignificant, or even inexistent. However, there are still condensers in copper alloy

which are protected by a film of ferric hydroxide produced by adding ferrous sulphate to the cooling water.

For **river-sited** power plants the contribution of chemical reagents will depend to a great extent on the type of cooling system and any biological problems.

Generally, operation with recirculation increases the **risks of scaling**. This often requires setting up a specific treatment of make up water or cooling water. The modes of treatment that may be used are as follows:

- no treatment when the water is not very mineralised,
- lime softening of make up water,
- acid vaccination of circulating water,
- treatment with precipitation retarder,
- combined treatments of the type: acid vaccination and scale inhibitors or lime softening and acid vaccination.

The choice of the mode of treatment depends on many criteria the following of which are mentioned for example:

- concentration factor,
- chemical composition of the river water,
- design of the cooling system.

The treatment depends on the concentration factor of the cooling system:

- with a low concentration factor (1.05 to 1.2), it is not generally necessary to treat the water of the system,
- with an average concentration factor (1.2 to 2), an acid vaccination of the circulating water is necessary when the hardness of the water is high,
- with a high concentration factor (3 to 7); the lime softening of make up water often becomes the only choice possible, and may be supplemented by a light acid vaccination.

The **acid vaccination** of circulating water can be carried out in three different ways: either by maintaining the pH within a range generally included between 7.5 and 8.5, or by limiting the total alkalinity to 100 mg CaCO₃/l (for make up water with low sulfate-content), or by respecting regulation instructions which take into account the alkalinity, calcic hardness and temperature. Sulphuric acid is used in most cases.

The purpose of the **lime softening** of make up water is to raise the pH of the water up to 10 so as to precipitate the calcium and part of the magnesium in the form of carbonate and hydroxide. At the outlet of the decarbonator, the concentration of residual calcium varies between 0.5 and 1 mequivalent. However, it is combined with carbonate, which makes the treated water extremely scaling. To restore the balance of decarbonated water, a post vaccination with sulphuric acid is often carried out. The lime softening results in the production of a large amount of sludge. In addition, by increasing the pH, lime softening may result in the precipitation of some heavy metals present in the withdrawn water.

The sludge produced by precipitation in the softening process is collected in the bottom of a clarifier. It is normally pumped to a sludge thickener, where the solids concentration increases by further sedimentation usually assisted by injection of polyelectrolyte. The clear water returns to the clarifier while the concentrated sludge is further dehydrated in vacuum drum filters or belt filters.

The cake produced by dehydration with remaining water content of approximately 50% is removed for disposal in landfills. No environmental effects have been reported from softening sludge landfilling sites.

The **continuous chlorination** of the circulating systems so as to eliminate the formation of biofilm on the condenser tubes was given up a long time ago since mechanical methods have been applied (Taprogge, Technos systems, etc.). But chlorination as such is still an effective treatment. In practice, five chlorination treatments can be applied:

- end-of-season; for example continuous chlorination at low level (0.5 mg/l) for 2 to 4 weeks at the end of the settlement period of the freshwater Zebra mussel *Dreissena polymorpha*;
- periodic treatment: several periods of continuous addition of biocide during the settlement season;
- intermittent treatment: frequent dosing (every day or three days for example) for short periods of time (some minutes to hours);
- continuous treatment at low level during the settlement period; for example in the North Sea and the English Channel, chlorination at 0.5 to 1.0 mg/l., 7 months a year, to eliminate marine mussels. Residual oxydant at the outlet 0.1-0.2 mg/l;
- semi-continuous treatment consisting of short term periods of treatment (15-60 minutes) then stopped for equally brief periods. A semi-continuous chlorination or pulse-chlorination at low level is used in Canada against the Zebra mussel and in France and the Netherlands to control the marine mussels in power stations.

The **massive chlorination or shock dosing** is a specific procedure that has been developed to eliminate filamentous algae which develop in the basins and the fills of cooling towers. The concentrations at the injection point vary between 5 and 25 mg Cl₂/l. In order to avoid the release of chlorine into the receiving environment, the blowdowns are closed for a few hours. They are open when the concentration of free chlorine in the circulating water is lower than the discharge limit. Depending on the authorisations, this limit varies between 0.1 and 0.5 mg TRO/l. Some discharge authorisations are expressed in flows. These treatments are not carried out on all the sites.

The frequency of massive treatments depends to a great extent on the quality of the water, the concentration factor and the general state of cleanness of the circulating system. It may be weekly, monthly or quarterly.

The reaction of chlorine with humic and fulvic matter leads to the formation of organochlorinated compounds. In fact, bromide ion concentrations in river water are generally insignificant. Under these conditions, only organochlorinated compounds can be formed. Volatile compounds such as chloroform, dichloromethane, (POX) and adsorbable compounds (AOX) can be distinguished.

However, as is the case for sea water, the presence of organohalogenated compounds in inland surface waters is not solely due to the chlorination of the cooling systems. Among the other possible sources, particular mention should be made of agriculture and natural production. In unpolluted lakes - for example in Sweden - AOX concentrations ranging from 10 to 190 µg Cl/l. The highest concentrations have been measured in highly eutrophicated lakes.

Among the parameters which affect the reactions resulting in the formation of organochlorinated compounds during the disinfection of cooling water, the following should be mentioned:

- humic or fulvic concentration,
- free chlorine concentration,
- reaction time,
- pH of the environment,
- reaction temperature,
- presence of ammonium ions.

These complex reactions can be modelled and validated by measurements carried out on the sites.

The chlorination of the once-through systems does not result in significant increases of organochlorinated compounds. Indeed, the contact times are short, about 10 minutes at most, and the concentrations of free chlorine are low. According to the chlorination procedures used, the POX and AOX concentrations measured at the peak vary between 0 and 10 µg Cl/l and between 20 and 150 µg Cl/l, respectively. These values correspond to free chlorine concentrations at the injection included between 0.5 and 10 mg/l.

The chlorination in a closed loop of circulating systems may lead to higher concentrations of organochlorinated compounds. The following factors play an unfavourable role here:

- the contact time is longer,
- the recirculation increases the concentration of precursors.

It should nevertheless be mentioned that the increase of pH linked to the degassing of CO₂ is favourable to the formation of POX. The latter are easily transferred to the atmosphere via the cooling tower.

Under these conditions, the concentrations of POX are included between 0 and 10 µg Cl/l and the concentrations of AOX between 200 and 2 500 µg Cl/l. For concentrations of free chlorine at the injection included between 5 and 25 mg/l and stay times varying between 2 and 70 hours.

One should note, however, that the presence of low concentrations of ammonium ion in natural water may considerably reduce POX and AOX concentrations. Actually, the kinetics of the chlorine-NH₄⁺ reaction is more rapid than those of the reactions taking place between the chlorine and aromatic compounds.

XII.3.5 Other possible harmful effects resulting from the choice of some cooling systems

The use of natural draught, forced draught and hybrid cooling towers, or also of dry condensers and cooling towers, makes it possible to considerably reduce the water flow requirements of a power plant and, consequently, to limit the possible impact on the aquatic-environment. However, the presence of cooling systems on a site may pose other problems. They concern in particular problems of aesthetics and noise of wet cooling towers. For dry cooling towers and condensers, in addition to the two previously mentioned aspects, there is also the possible dissemination into the air of corrosion products from the heat exchange surface area, in particular, when the heat exchangers consist of finned tubes made of galvanised steel.

Natural draught wet cooling towers, the sober form of which is generally not unpleasant, are nevertheless structures that can be seen from afar and that cannot be concealed in a fairly flat landscape.

On the other hand, **mechanical draught wet cooling towers or hybrid cooling towers**, the aesthetics of which is itself much more debatable, present the advantage of generally being lower than the main part of the power plant.

Nevertheless beyond that it is required to quote comparative factors between different technologies since a lot may depend on the assumptions made by manufacturers in giving cost data.

Similar remarks may be made for **dry cooling towers and air-cooled condensers**. The size effect is nevertheless much more considerable. This is because the low exchange properties of air require much larger structures. In addition, in the case of mechanical draught systems, the power necessary for air supply is about 2% of the unit's net electrical output. For the same

thermal power to be dissipated, the size effect is therefore three times higher than that required for wet cooling towers and combined systems.

A certain detrimental effect that can be caused by a cooling system resides in the emission of noise at the air inlet and outlet. Even for a **natural draught wet cooling tower**, the sound level may reach 60 dBA at 100 m. For a **mechanical draught wet cooling tower and hybrid cooling tower**, the noise level comes to about 70 dBA under the same conditions. It is close to 80 dBA for **air-cooled condensers**.

XII.4 Prior study of the sites: indispensable tool for the evaluation of their receiving capacity, impact control and prevention of harmful effects

XII.4.1 Analysis of the situation

The cold source is one of the determining elements in the choice of a site. That's why great care is taken at a very early stage with regard to the environmental problems posed by the cooling of a power plant. As mentioned earlier on, these problems may be of several kinds:

- water heating by once-through systems,
- effect on the quality of water and on aquatic organisms, in the case of wet cooling towers,
- effect on the quality of air, in the case of dry cooling towers,
- meteorological effects, discharges of chemical substances and problems of noise regardless of the mode of cooling adopted.

The designer is not powerless in the face of the problems posed. The knowledge acquired through great many observations made in the vicinity of existing power plants constitutes a solid experimental basis serving to effectively orient the studies to be undertaken prior to the installation of a new power plant.

XII.4.2 Mathematical modellings, simulations on models and tests on pilot loops, first indispensable tools

The interest of **numerical models** has been mentioned for forecasting thermal changes in the near field as in the far field.

In the near field, fairly sophisticated tools serve to describe the dilution conditions of thermal discharges. They are used at the local discharge level. These models serve to dimension the outfall structures to the best possible extent so as to ensure the optimum dispersion of the warm water plume in the receiving environment as quickly as possible and thus limit its impact to a minimum (meteorological and hydrobiological data).

In the far field, the parameters that have to be taken into account are much more complex. They concern not only the characteristics specific to the receiving environment, but also discharges originating from other companies. Much more complex models have been developed to this effect. They take into account biological parameters of water quality and take into account the presence of chemical pollutants. They integrate various pollution sources and provide an assessment of response of waterways or lakes to thermal and chemical disturbances or the excessive contribution of nutrients (eutrophication phenomenon).

There are also other models used to simulate the accumulative impact of several wet cooling towers installed on the same site.

The forecast making use of numerical models must rely on field data and experimental knowledge. These **in situ and laboratory studies** are required to define and optimise the anti-fouling treatment or systems cleaning periods. Biological studies make it possible to know the

periods of reproduction and fixation of larvae, as well as the rate of growth of the main biological species. These field and laboratory studies are long. Indeed, in the ecological field, forecast analytical tools have not yet been wholly validated.

To determine the mode of treatment of the recirculating systems, systematic tests on pilot loops are carried out. The purpose of these tests is to grasp the **scaling risks** on the one hand and on the other hand to define the optimum mode of treatment, as well as the operating instructions. Among the laboratory studies are to be found model simulations, such as for the visualisation of water vapour and warm water plumes phenomena.

XII.5 Design of components and choice of materials

XII.5.1 Wet cooling

As mentioned previously the problems encountered in wet cooling systems may be of three types:

- corrosion,
- scaling,
- biological developments.

For many years now, and almost naturally, the choice of materials used in the cooling systems of power plants has been oriented towards corrosion-resistant materials. It must be mentioned that the pressure within the condenser of a power plant is about 35 mbar but can be lower in units optimised to achieve higher efficiency - in particular when climatic conditions are suitable or may be even higher when climatic conditions are unfavourable. Under these conditions, the slightest leak in the tubes leads to the ingress of impurities into the water-steam cycle. The damage incurred by these intrusions may be substantial and reduce the efficiency of the unit, or even lead to its shutdown.

In order to avoid the ingress of raw water into the water-steam cycle, the choice of materials went to highly resistant alloys. Titanium is thus almost always used in seawater and brackish water. For river water, condensers are equipped with 316L (or even higher Mo-content if concentration of chloride ions is higher than 100 mg/l) stainless steel tubes most often or brass or sometimes made of titanium. In order to limit the formation of deposits (sediments and biological developments) in the tubes, the minimum average velocity is fixed at 1.8 m/s for brass. For other material as stainless steel or titanium, the maximum average velocity is much higher. The choice of the average velocity is in fact the result of the optimisation of the cold end taking into account the power required for the pumping that is the function of the velocity in the tubes. Generally, the optimisation for stainless steel or titanium leads to a velocity in the range of 1.8 - 2.5 m/s.

The tube plates are often made of carbon steel or titanium cladding. Appropriate painting (epoxy or ebonite coating) protects the side in contact with the recirculating water. In some particular cases, cathodic protection devices have been installed to solve galvanic corrosion problems among others.

Even if rich, alloys such as stainless steels may be the subject of particular corrosion, like corrosion beneath deposits. To avoid these phenomena, the tubes must remain clean under all circumstances. This objective may be met in two ways:

- either by a continuous injection of rapid-action biocides, generally an oxidising biocide, such as chlorine;
- or by a continuous mechanical cleaning process. There are various processes in existence. They consist in the injection of brushes or foam balls, which are recovered and reused on a continuous basis.

The desire to reduce the use of chemical reagents imposed the second solution.

To avoid corrosion of stainless steel, a particular procedure is recommended for the conservation of the tubes that is carried out during long shut down of the installation. This conservation consists of draining, washing and drying the inside of the tube.

The main heat exchangers of auxiliary cooling systems generally consist of coolers made of steel or stainless steel. The distance between the plates is relatively short, which sometimes leads to silting up. However, these systems operate according to the one of two or two of three principle. In other words, the operation of one or two systems is sufficient to carry out the cooling of the auxiliaries, with the additional train playing the security role. This design choice serves to schedule periodic cleaning operations. These operations consist in dismantling the unused heat exchanger and in cleaning the plates with pressurised water.

The make up and outfall structures, main circulating water conduits and cooling towers are made of reinforced concrete. The choice of cement used depends on the mode of treatment to be adopted for the circulating water. Thus, in the case of sulphuric acid vaccination, it is sometimes indispensable to use special cements. The addition of fly ash is recommended. In the case of higher sulfur acid concentration the use of special coatings is required.

The **fill** of cooling towers is usually made of thermoplastic materials. Specific loads are often added during fabrication so as to make them fire resistant. The risk of fire in the fills is particularly high during the maintenance operations. This choice avoids the problems of asbestos encountered with the packings of the previous generations. In addition, recent developments have made it possible to substantially increase the thermodynamic properties of the fill. The choice of lighter synthetic materials and enhanced performances has served, for an identical thermal load, to appreciably reduce the size of cooling towers. However, some present profiles show a larger sensitivity to (bio)fouling and scaling.

As can be seen, the choice of a fill depends on several factors. More than the performances sought, it is rather the quality of water (presence of suspended matter, scaling tendency) which imposes the choice of the profile. The manufacturers still have a great deal of progress to make with regard to this particular point. The ideal profile is, of course, the one which guarantees high performances while being not very sensitive to (bio)fouling and scaling.

The standard **drift eliminators** currently used make it possible to limit the amount of water drawn in by priming to 0.01% or even less of the total flowrate. For facilities built near major trunk roads, these values can be further reduced. A compensation of loss of capacity is necessary in this case. Separators are also made of plastics.

Part of the **pumping energy** can be recovered by installing cooling towers equipped with recuperators located under the fill. However, these cooling towers are extremely sensitive to frost. Before opting for this solution, a study of local climatic conditions is absolutely necessary.

XII.5.2 Hybrid cooling

Hybrid cooling towers are recommended for special site conditions. The essential characteristic of hybrid cooling towers is to combine an evaporative process with a non-evaporative process. This results in a decrease of relative humidity and therefore the almost complete disappearance of the plume at the outlet of the cooling tower. In connection with mechanical draught it is possible to reduce the tower height considerably. The investment costs are higher than for a wet cooling tower.

In general the energy consumption related to the operation of fans and the higher temperature of the cold source, result in lower cycle efficiencies and higher fuel consumption.

XII.5.3 Dry cooling

Dry cooling is mainly used in regions with insufficient water supply.

XII.5.3.1 Forced draught air-cooled condenser (Figure XII.9, Section XII.11)

In an air-cooled condenser arrangement the exhaust steam from the steam turbine is ducted to the air-cooled condenser (ACC) where the steam is distributed through a large number of finned tubes. Cooling air is forced over these tube bundles by fans. The steam rejects heat directly to the atmosphere via the finned tubes, condenses and flows by gravity into a condensate tank. From the condensate tank it is returned to the boiler. A typical design for the heat exchanger is the “A” frame condenser (other framework designs are also possible to accommodate the tube elements, fans, and steel structure).

Large dry condensers tend to have long and complex steam tube systems, which may cause siting, and pressure drop problems. To minimise pressure losses in the steam ductwork the cooling bundles are generally located immediately adjacent to the turbine hall. Depending on-site conditions, the ACC concept is technically feasible to cover a wide range of power plant unit sizes.

Compared to wet cooling systems, the ACC’s efficiency of heat transfer to the atmosphere is relatively low with the re-cooled water temperature being determined by the dry bulb air temperature. The system needs to be designed to exclude formation of dead zones by non-condensable gases and thus eliminate the danger of undercooled condensate or freezing. The design of tube bundles also needs to be robust to allow for periodic high-pressure water cleaning of the external surfaces to maintain efficiency and plant output. However, this method of dry cooling with an ACC avoids the need for large cooling towers, eliminates the vapour plume and greatly reduces the consumption of cooling water. In particular using low noise fans and drives can meet stringent noise restrictions.

In comparison to indirect dry cooling systems, then the ACC provides a greater temperature difference between the condensing steam and the cooling air, and consequently the ACC system will have a relatively smaller heat transfer surface. The indirect dry cooling system, which has two heat transfer processes (i.e. steam condenser and Air-cooled heat exchanger) would need to compensate by either adopting a larger cooling surface and/or by increasing its cooling airflow. The investment costs for an ACC will be smaller than an indirect dry cooling system as the latter will have to include the costs of the cooling water recirculation pumps and surface condenser. On the other hand, the auxiliary power consumption and maintenance requirements for the mechanically forced draught ACC will be significantly greater than the natural draught dry tower.

XII.5.3.2 Natural draught air-cooled condenser (Figure XII.10, Section XII.11)

Although the characteristics of placing a direct air-cooled condenser inside a natural draught tower make it as feasible as a forced draught air-cooled condenser, the disadvantages are that the height of the natural draught tower structure will be larger and so will its investment costs. For example, the cost of the tower itself, the routing of the large steam exhaust ducts to the cooling tower, and the larger heat transfer surface required as the natural air draught may be only half that of a forced air draught tower.

The advantages of this natural draught ACC system would include:

- reduced/no sound emissions
- reduced/no air recirculation due to high tower structure
- no maintenance for fans, drives or circulation water pumps
- no auxiliary power consumption for steam condensation.

XII.5.3.3 Closed recirculating dry cooling towers

(Figure XII.11, Section XII.11)

In dry cooling towers water flows through the cooling elements in a closed system. Waste heat is exclusively transmitted by convection. The lack of heat dissipation through evaporation loss leads to a significant increase of the temperature of the cooling water and thus a low efficiency compared to wet-cooling.

In case of dry cooling two flow arrangements are possible:

- closed circuit cooling with dry-type cooling towers as direct cooling in connection with a surface condenser and
- closed circuit cooling with dry-type cooling tower as direct cooling in connection with injection condenser.

Advantages of dry cooling are as follows:

- no visible plume formation,
- simple set-in and examination of chemical parameters of the circulating cooling water,
- no need to make up water during operation, only replacement of possible leakage losses.

Compared to wet cooling, dry cooling has the following disadvantages:

- considerably higher investment and operation costs,
- larger dimensions of the building,
- stronger influence of the ambient air temperatures (summer/winter) on cooling performance,
- operation in winter requires special ice prevention measures during standstills,
- the tendency to fouling of the cooling elements requires an efficient stationary cleaning device.

XII.5.4 Cooling towers with discharge of cleaned flue gas

(Figure XII.12, Section XII.11)

During the last years the emission of desulphurised flue gas via cooling towers (as an alternative to the emission via chimneys) in fossil-fired plants has proved to be favourable regarding environmental and economical aspects. The effect of the transport of flue gas to higher atmosphere areas is achieved in this case by differences in density between the flue gas/cooling tower plume mixture inside the cooling tower and the relatively cold ambient air, and not by the high temperature of the flue gas itself. Using this method an increase of the efficiency of the power plant is obtained.

Flue gas desulphurisation plants of coal-fired power plants often work according to the principle of wet desulphurisation. Wet cleaning cools down warm flue gases to between 50 °C and 70 °C. For environmentally-compatible and troublefree emission of these cleaned flue gases via a chimney a heating under additional utilisation of energy is necessary. An alternative for reheating is the clean gas emission via a natural draught cooling tower: up to now this principle has been exclusively used for wet cooling. The clean gases are led into the cooling tower above the packing and thus emitted into the atmosphere together with the cooling tower plumes.

The inner side of the cooling tower shell including the upper ring beam must be completely **coated against corrosion**. During the inlet of clean flue gases into the cooling tower, condensate can flow down the cooling tower shell, which is, compared to concrete, heavily aggressive due to its low pH value.

Concrete parts of the internal structure, e.g. the top framing of the fill supporting structure of channel segments and riser heads respectively, must also be coated similar to the inner side of the shell.

Steel parts, e.g. slides or handrails that might get into contact with acid condensate from the plumes must be made out of special stainless steel.

The **clean gas channel** conducts the clean gases from the FGD²¹ building to the middle of the cooling tower. It can be inserted into the cooling tower at the height of the FGD outlet (high elevation) or right above the internal tower fill (low elevation). The maximum channel diameter is about 8 m.

The clean gas channel should be made out of glass fibre reinforced vinylester or equivalent. To this end, especially chemical-resistant moulding materials on the basis of penacryl resins and, as textile processing, especially acid-resistant fibres out of ECR glass are to be used.

Due to the condensate formation inside the channel, it should have a slight inclination against the cooling tower. For the outlet of the condensate, an outlet facility at the clean gas channel inside the cooling tower is to be provided, leading into the cooling tower basin.

XII.6 Cost comparison between the various types of cooling towers

The cost elements of cooling systems are mainly of three kinds:

- investment costs,
- costs related to energy consumption (i.e. efficiency),
- and maintenance costs.

For power plants, operating costs related to energy have to take into account the financial gain that is linked to the difference in efficiency between different options. Generally for power plants, the comparison of different options is executed through a socio-economic method based on an 'actualised' balance with an 'actualisation' ratio that varies from country to country (e.g. 8% for France, 5% for Germany and Italy, 10% for Portugal). This method is described in reference L. Caudron, "Les réfrigérants atmosphériques industriels", Collection de la Direction des Études et Recherches d'Électricité de France, 1991.

The 'actualised' balance is composed of:

- investment added with indirect charges to technical solutions considered I;
- algebraic 'actualised' expenses (maintenance of equipment) and receipts in operation (production during the estimated life « t_f »);
- « P_i » is the balance of expenses and receipts of the year « i », supposed in the middle of the year.

The balance is represented by the following enumeration with « α » as the actualisation ratio:

$$I + \sum_{i=1}^{i=t_f} P_i / ((1 + \alpha)^{I-1/2})$$

With the expenses counted positively, the criterion of choice between different solutions is the lowest actualised balance.

²¹ Flue gas desulphurisation.

In the case of mechanical draught cooling towers, one may suppose that the maintenance costs are very similar because they are mainly linked to the maintenance of the fans. By taking into account the first two criteria and by selecting the least expensive solution as the reference, Table XII.3 shows that the wet system is much more economical than the dry system, natural draught more than mechanical draught. From an economic point of view dry systems would be less recommendable as they are more expensive and have a higher influence on the cost of kWh. So dry systems may be recommended only in the case of lack of water.

Table XII.3: Comparison of different types of recirculating cooling systems with a lifetime of 25 years and an actualisation ratio of 8% (study on EDF units of 1300 MWe)

[L. Caudron, "Les réfrigérants atmosphériques industriels", éditions Eyrolles]

Type of refrigeration system	Wet cooling tower		Wet/dry cooling tower	Dry cooling tower	
	Natural draught	Induced draught	Induced draught	Natural draught	Induced draught
Approach K (dry air 11°C/wet air 9°C)	12.5	12.5	13.5	16	17
Nominal condensation pressure (mbar)	63	63	66	82	80
Thermal power (MWth)	2458				
Electrical power Delivered (MWe)	1285	1275	1275	1260	1240
Fan power MW	0	10	12	0	26
Pump power MW	13	13	8	14	13
Cost of refrigerant	1	1.25	2.3	5.7	4.8
Cost of cold end	1	1.1	1.6	3.6	3.1
Difference of cost of kWh/cost of kWh (%)	0	1.0	2.4	8.4	8.9

Table XII.4: Comparison of wet cooling towers and aircooled condenser with a life-time of 20 years and an actualisation ratio of 8% for a combined cycle unit 290 MWth

Type of refrigeration system	Once-through	Wet cooling tower		Air-cooled condenser
		Natural draught	Induced draught	
Approach K (dry air 11°C/wet air 9°C)	/	≈8	≈8	≈29
Nominal condensation pressure (mbar)	34	44	44	74
Thermal power (MWth)	290	290	290	290
Difference of electrical power delivered (MW_e)	+ 0.6	0	0	- 1.8
Fan and pump power (MW)	1.9	1.95	3	5.8
Global difference on electrical power in (MEuro)	-4.7	-2.9	0	12.6
Difference in cost on water consumption (MEuro)	-8.9	-8.9	0	0
Difference in cost of cooling system in (MEuro)	-3.0	1.9	0	8.9
Cost of cooling system	0.82	1.11	1	1.54
Global balance of costs (MEuro)	-16.5	-1.0	0	12.6

The same comparison can be done for combined cycle plants. Table XII.4 shows that dry systems are more expensive again than wet systems, but the difference is smaller than in case of conventional power plants. The difference between mechanical and natural draught is small and is more or less comparable. Wet systems are preferred to dry systems. Maintenance costs, eventual taxes for make-up or blowdown flows of water and costs of chemical products necessary to the treatment of water are not taken into account in this table, which may underestimate the cost of wet systems or overestimate the cost for dry cooling. Thus, dry systems may be recommended depending on the price of water and water treatment for wet systems or taking into account the lifetime of the plant, where a shorter lifetime reduces the differences between dry and wet systems.

An important factor in cost comparisons is the efficiency or rather the loss of efficiency due to cooling with less efficient cooling systems. This loss is measured in the dimensionless energy-temperature factor $\text{kW}_{\text{th}}/\text{MW}_{\text{th}}$ per degree temperature difference of the cooling water (in K). In the following theoretical example this factor is derived [Paping, pers. comm.].

From the definition that 100 bar steam of 530 °C is equal to 3451 kJ/kg it follows (using Mollier diagram) that:

50 [mbar]	32.7 [°C]	2110 [kJ/kg]
60 [mbar]	35.6 [°C]	2130 [kJ/kg]
70 [mbar]	38.8 [°C]	2150 [kJ/kg]

Above mentioned vacuum pressures and their related condensation temperatures are also related to an average cooling water temperature in Europe of 15 °C together with a increase of 10 °C of the cooling water in the condenser itself.

Including the heat transfer coefficient of the condenser, the condensate will leave it with a total temperature of 30 °C and an inseparable vacuum pressure of about 43 mbar (see Table XII.3 and Table XII.4). Thus, to calculate the energy-temperature factor for increasing cooling influent temperatures the calculation for is started with 50 mbar.

The efficiency is calculated following the Carnot cycle resulting in an efficiency, which is in line with the commonly used 40% for conventional power plants:

$$\begin{aligned} \text{at 50 mbar} &= (3451 - 2110) / (3451 - 4.18 * 32.7) \times 100 = 40.4609\% \\ \text{at 60 mbar} &= (3451 - 2130) / (3451 - 4.18 * 35.6) \times 100 = 40.0037\% \\ \text{at 70 mbar} &= (3451 - 2150) / (3451 - 4.18 * 38.8) \times 100 = 39.5583\% \end{aligned}$$

The minimum efficiency loss expressed per degree temperature difference under ideal (thermodynamic) circumstances:

$$\begin{aligned} \text{efficiency difference between 50 mbar and 60 mbar} &= 4.572\text{‰ per 2.9 K difference} \\ \text{efficiency difference between 60 mbar and 70 mbar} &= 4.454\text{‰ per 3.2 K difference} \\ \text{efficiency difference between 50 mbar and 70 mbar} &= 9.026\text{‰ per 6.1 K difference} \end{aligned}$$

This efficiency loss can be further expressed with respect to the total efficiency and per K:

$$\begin{aligned} 4.572\text{‰} / (2.9 \text{ K} * 0.4) &= 3.9 \text{ kW}_{\text{th}}/\text{MW}_{\text{th}} \text{ per K difference} \\ 4.45\text{‰} / (3.2 \text{ K} * 0.4) &= 3.5 \text{ kW}_{\text{th}}/\text{MW}_{\text{th}} \text{ per K difference} \\ 9.026 \text{‰} / (6.1 \text{ K} * 0.4) &= 3.7 \text{ kW}_{\text{th}}/\text{MW}_{\text{th}} \text{ per K difference} \end{aligned}$$

From this simplified calculation it appears that for an efficiency of about 40% the loss or gain per degree of temperature difference of the cooling water can be estimated using the factor of $3.5 \text{ kW}_{\text{th}}/\text{MW}_{\text{th}}$ per K.

XII.7 Choice of the treatment of circulating water alternative methods - monitoring

As mentioned previously, problems of corrosion seldom arise in the cooling systems of power plants. The use of corrosion inhibitor products is therefore unnecessary for cooling systems cooled by raw water.

XII.7.1 Anti-scale treatment

With a wet cooling system, the only way of reducing heat discharges into the aquatic-environment consists in the recirculation of the cooling water. This practice results in increasing the concentration factor (Table XII.5). It is often applied for power plants located on **inland waterways and in estuaries**.

This concentration tends to result in the precipitation of calcium salts that are not very soluble: carbonate, sulphate, phosphate. The scale most commonly encountered is calcium carbonate. It settles on the tubes of condensers and in the fill of cooling towers, which leads to a reduction in efficiency. Two prevention techniques are generally used to avoid the precipitation of calcium carbonate in the cooling systems of power plants. One is the lime softening of make up water and the other is the vaccination of circulating water with sulphuric or hydrochloric acid.

Table XII.5: Relationship between the concentration factor, the withdrawn water flowrate and the energy discharged into the receiving waterway (individual example)

Concentration factor	Withdrawn water flowrates (m ³ /h)	Energy discharged into the receiving waterway (%)
1	36000	100
1.2	3600	8.3
1.3	2600	5.5
1.4	2100	4.2
1.5	1800	3.3
2.0	1200	1.7
3.0	900	0.8
4.0	800	0.5
5.0	750	0.4
6.0	720	0.3

Only organic scale inhibitors for which there are ecotoxicological data are used within the limits laid down by regulations. Their use is extremely limited. Indeed, current ecotoxicological data are often insufficient. Furthermore, these substances released into the receiving waterway may disturb the water treatment operations of industries situated downstream of the discharge point.

Coastal-sited power plants are generally cooled by a once-through system. Cooling towers operating on an after cooling basis can be installed in order to reduce the thermal load. This choice will mainly depend on local conditions (tides, mixture, etc.).

On the other hand, operation with sea water recirculation is exceptional. Indeed, high concentration factors may cause the precipitation of a great many salts (calcium carbonate, calcium sulphate, barium sulphate, etc.). Although the formation of calcium carbonate may be avoided by adding acid, the same does not hold true for the other salts which can only be stabilised by organic inhibitors (phosphonates, polyacrylates, copolymers, etc.).

XII.7.2 Anti-fouling treatments (biocides)

A recent review of the experience acquired in EUROPE in methods to reduce biological fouling enables to draw the following conclusions:

Mechanical cleaning of the systems and **water filtration** are the most commonly used processes. They involve the continuous cleaning of the tubes of condensers by foam balls or brushes, manual cleaning, use of trash rakes, filters with meshes of different widths.

Three other physical methods are also regularly used for the anti-fouling treatment of industrial systems. They concern the following:

- maintaining of velocities high enough to avoid the fixation of organic organisms ($v > 2$ m/s), this recommendation is applied to a large extent today;
- temperature increase which consists in raising the temperature of the cooling water beyond 40°C for some dozens of minutes; this technique eliminates the fixed organisms (mussels), but nevertheless requires an appropriate design of the cooling systems;
- non-toxic coatings and paints, which reduce the fixation of the organisms, reinforce the velocity effect and facilitate cleaning; these coatings are nevertheless expensive and must be renewed every 4 to 5 years.

Other techniques are sometimes used, the following in particular:

- dryout;
- installation of specific filters (mussel filters).

The physical methods can be applied both in sea water and soft water.

A non-chemical treatment applied in a few cases is UV.

Chemical treatment can be applied in cases where physical methods are not appropriate or show insufficient results. There are oxidising products, chlorine, monochloramine, ClO_2 and ozone, which can be used as antifouling treatments. Some degradable organic compounds applicable intermittently and non toxic in the receiving environment, might be an alternative to chlorination. Among these, some amine filminducing polymers appear to be promising as anti-corrosion chemicals, but so far intermittent treatment of ferro-sulphate is more efficient.

XII.7.3 Monitoring

Given the flowrates of power plant cooling systems, one cannot conceivably operate them without an advanced monitoring and control system. This reasoning is applicable both for problems concerning scale and biological development.

To avoid **scaling**, the regulation of acid injection into the circulating water is generally subject to the continuous monitoring of physico-chemical parameters such as: alkalinity, calcic hardness, conductivity, temperature at the condenser outlet. A computer uses these various parameters as a basis to calculate a specific scaling index and compares it with the operating instructions. If necessary, the regulator adapts the injection pump flowrate. Finer control methods are also implemented in high-risk sites. They concern in particular the measurement of the critical pH 4 and other scale monitors.

As concerns the follow-up of **biological developments**, many types of sensors exist and are implemented. Among these should be mentioned biomonitors, and electrochemical sensors.

A control of the quality of drainage water is desirable in order to monitor parameters like temperature, oxygen concentration, pH, conductivity etc.

XII.8 Design of the cooling system

As a non-neglecting requirement it should be recognised that the adoption of cooling water systems at a particular site can be the collaboration of many different factors. The most obvious one is the site-specific characteristics.

XII.8.1 Design and energy recovery

In conventional thermal power plants, the thermodynamic cycle imposes the overall efficiency of the facility. The economiser, superheater and reheater optimise the operation of the boiler. The low and high-pressure superheaters raise the temperature of feedwater by recovering part of the energy withdrawn by means of steam extractions. In order to reduce the electrical consumption of the auxiliaries, turbine-driven feedwater pumps are also used, these being also supplied by steam extractions. Combustion air is also heated by air heaters prior to entering the boiler. All of these devices have one objective: **reduce the energy losses of the cycle.**

Thermodynamic laws govern the energy loss in the condenser.

If energy gains can be obtained in the cooling systems, it is mainly at the level of design and the resulting choices that it is possible to do so. Some golden rules may be applied:

- limit the number of pumps,
- avoid mechanical draught cooling towers,
- if cooling tower is needed, prefer wet cooling tower to recovery systems (recuperators),
- if deconcentration flowrates are sufficient, install a hydraulic recovery turbine on the deconcentration blowdown;
- where flowrates must not be constant, use frequency variators on the pumps or fans.

The following conclusions therefore emerge from these observations:

- two sets of pumps are sufficient, one for the supply of the auxiliary cooling system, the other for the main cooling system;
- if once-through cooling is not possible, natural draught wet cooling towers should be preferred to other cooling systems;
- two schemes are therefore conceivable (Figure XII.13 and Figure XII.14 in Section XII.11) and make it possible to eliminate the heat from the auxiliary system via the cooling tower.

XII.8.2 Design and noise reduction measures

The reduction of noise of the cooling systems can be carried out in different ways:

- installation of anti-noise walls around cooling towers,
- modification of the relief of the site (wooded slopes),
- choice of "low noise" fans,
- utilisation of anti-noise panels.

These various solutions generally make it possible to meet stringent noise restrictions.

XII.8.3 Implementation of physical methods

Right from the design stage, it is absolutely necessary to reflect on the possibilities of implementing physical methods, particularly so as to avoid biological developments. It concerns the following in particular:

- guarantee an adequate velocity in all the portions of the system;
- install continuous cleaning systems on all heat exchangers whenever this is technically possible;
- provide for mussel filters on sites at risk;

- design the systems so as to be able to carry out manual cleaning operations under normal operating conditions (alternate heat exchanger operation);
- design the systems so that temperature increase is possible (recirculation with cooling tower in by-pass);
- in natural draught wet cooling towers prefer fill with a suitable surface and/or structure to reduce fouling; periodic cleaning should be optional, e.g. in case of high contents of solids in the used cooling water.

XII.8.4 Modelling and pilot tests

The purpose of **modelling** is to study any physico-chemical impacts and adapt to the facilities so as to reduce these impacts to the greatest extent possible. It is particularly important to study:

- water withdrawals and discharges,
- the visual aspect of the site,
- the evolution of plumes,
- the thermal and chemical impacts on the receiving environment.

The objective of the **pilot loop tests** is to define the optimum treatment of cooling water both with regard to scaling and to any biological developments. To do so, pilot facilities representative of real commercial operating conditions are installed on the site for up to one year. In general those pilot test should last for a period with a minimum length which makes it possible to integrate the variations of the quality of the cooling water due to seasonal differences. This also serves to assess the opportunity of some choices on a representative scale (examples: choice of cooling tower fill, choice of alloys, etc.).

XII.8.5 Choice of the cooling system

As can be seen in the examination of the previous analysis, the choice of the type of cooling system essentially depends on local site-specific conditions. It is therefore extremely difficult and may not be appropriate to offer a unique recommendation. The decision-making logic diagram shown in (Figure XII.15, Section XII.11) gives an idea of all the conceivable cases involved.

From the energy standpoint, wet cooling (once-through cooling if necessary with wet cooling tower) is by far the most economical solution combined with the ecological advantage of saving energy and avoiding flue gas emissions. Whether it is carried out using the once-through technique or via a circulating system with wet cooling tower, the energy balances are favourable to this solution.

Of course, such wet cooling can only be envisaged if the receiving waterway is able to accommodate it. Within the scope of the sustainable management of water resources, it is absolutely essential that this point has to be examined carefully, particularly by taking into account future developments. A long-term modelling, integrating statistical data, is a necessary tool for estimation and assessment of the environmental impacts. It is in the basis of this essential approach that the choice of the cooling mode, concentration factor and any treatments must be made.

XII.9 Conclusions

A BAT approach for the cooling systems of **new** thermal power plants requires a series of reflection points:

1. the need to carry out prior studies concerning site-conditions;
2. the choice of corrosion-resistant materials for the heat exchange surface of condensers and cooling towers;
3. the implementation of local protection (paints, cathodic protection, etc.);
4. the reduction of energy consumers (fans, pumps);
5. the installation of anti-noise systems (walls, panels, modification of the site-relief, etc.) or the choice of solutions resulting in lower emissions (low noise fans);
6. the optimisation of the use of treatment reagents and the setting up of (bio)monitors and chemical monitoring and control devices;
7. the study of systems so as to be able to carry out temperature increase operations;
8. the design of water intakes to limit the drawing in of living organisms;
9. a control of the quality of water discharges by the drain (temperature, oxygen, etc.).

Points 3, 4, 5, 6 and 9 are also relevant for **existing** power stations as they concern the way a plant is operated and maintained. The other issues relate to the site assessment, which in for an existing installation is a given fact. With respect to those points, the result of an evaluation for an existing installation may lead to a considerable change in the design of an existing cooling system, which generally is expensive and likely to be not cost effective. In those situations the depreciation time of the installation (heat exchanger, intake structure), will affect any possible change resulting from a site assessment.

From the experience no single solution seems to have emerged. Each case is a specific one and depends, for example, on the cycle of the power plant. In the case of units with recirculating systems, the choice of the water treatment will depend on the concentration factor selected, maximum temperatures and the quality of the water withdrawn. The same holds true for the fight against biological developments. Although macroorganisms can generally be eliminated by thermal shocks, this solution cannot be applied to eliminate biofilm.

XII.10 Literature

- B. Vincent, "Exploitation et maintenance de la source froide", Revue Générale Nucléaire, n° 3, 247-257, mai/juin 1986.
- R. Gras et J. Jacquet "Problèmes d'environnement liés à la source froide des centrales thermiques", École d'Été de mécanique des fluides, 353-393, 6-10 octobre 1975.
- H.A. Jenner, C.J.L. Taylor, M. Van Donk, M. Khalanski, "Chlorination By-products in Chlorinated Cooling Water of some European Coastal Power Stations", Marine Environmental Research, vol. 43, n°4, pp. 279-283, 1997.
- R. Ambrogi, "Environmental Impact of Biocidal anti-fouling Treatment by Chlorine Dioxide". Proceedings of the First European Symposium on Chlorine Dioxide. Collana ambiente, vol. 17, pp. 119-132, Rome, 1996.
- L. Duvivier, "Etude des divers procédés de lutte contre l'entartrage des circuits de réfrigération des centrales électriques", Travail de Fin d'études, Université Catholique de Louvain, Facultés des Sciences Appliquées, juin 1988.
- G. Gutner, "Aéroréfrigérants secs et mixtes", École d'Été de mécanique des fluides, 60-69, 6-10 October 1975.
- Proceeding: Cooling Tower and Advanced Cooling Systems Conference, EPRI TR-104867, February 1995.
- L. Duvivier, "Concentration et conditionnement des eaux de surface intérieures dans les circuits de refroidissement atmosphériques des grandes centrales thermiques", 36^{èmes} Journées internationales du CEBEDEAU, 205-234, Liege, 25-27 mai 1983.
- Deleval, Duvivier, Hosdain, "Lutte contre l'entartrage des circuits de réfrigération des centrales électriques", 9th Cooling Tower and Spraying Pond Symposium-International Association for Hydraulic Research, Institut von Karman, 20-23 septembre 1994.
- L. Duvivier, "Considérations générales relatives à l'entartrage des circuits de réfrigération industriels", Proceedings Journées Information Eaux, Vol. 1, 311-3111, 18-20 septembre 1996.
- H.A. Jenner, J.P.M. Mommen, "Driehoeksmosselen en aangroeiproblemen", H₂O, 18^{de} jaargang, nr. 1, pp. 2-6, 1985
- Guide de l'environnement non radioactif - Protocole de chloration massive des réfrigérants, EDF-SPT, Département Sécurité - Radioprotection - Environnement, juillet 1984.
- Aprosi, Bidard, Nepveu de Villemarceau, "Expérience d'exploitation des réfrigérants des centrales françaises: hydrobiologie - chimie aquatique", Revue Generale Nucléaire, n° 5, 425-429, septembre/octobre 1986.
- Rook, "Formation of Haloforms during Chlorination of Natural Waters", Water Treatment and Examination, 23 (part 2), 234, 1974.
- Bellar, Lichtenberg, Kroner, "The Occurrence of Organohalides in Chlorinated Drinking Waters", JAWWA, 66, 73, December 1974.
- Amy et al., "Evaluation of THM Precursor Contributions from Agricultural Drains", JAWWA, 57-64, January 1990.

-
- G. Asplund, A. Grimvall, "Organohalogenes in Nature - More widespread than previously assumed", *Environmental Science and Technology*, 25, pp. 1346-13450, 1991.
 - L. Duvivier, "Formation et élimination des organo-halogénés lors de la désinfection des eaux", Thèse de Doctorat en Sciences Appliquées, Université Catholique de Louvain, juin 1993.
 - C.T. Jafvert, R.L. Valentine, "Reaction Scheme for the Chlorination of Ammoniacal Water", *Environ. Sci. Technol.*, Vol. 26, n° 3, 1992.
 - Bilello, Singley, "Removing Trihalomethanes by Packed Column and Diffused Aeration", *JAWWA*, 62-71, February 1986.
 - Munz, Roberts, "Air-Water Phase Equilibria of Volatile Organic Solutes", *JAWWA*, 62-69, May 1987.
 - Isaac, Morris, "Rates of Transfer of Active Chlorine between Nitrogenous Substances", *Water Chlorination - Environ. Impact and Health Effects*, Vol. 3, 1980.
 - Weil, Morris, "Kinetics Studies on the Chloramines. The Rates of Formation of Monochloramine, N-chloromethylamine and N-chlorodimethylamine", *Jour. Am. Chem. Soc.*, Vol. 71, 1979.
 - 4 S.A. Hubbs et al., "Use of Chlorine Dioxide and Chloramines as alternate Disinfectants at Louisville", *Proceedings AWWA Seminar, AWWA Conference*, pp. 51-60, Atlanta, 15 June 1980.
 - Neden et al., "Comparing Chlorination and Chloramination for Controlling Bacterial Regrowth", *JAWWA*, 80-88, July 1992.
 - "Centrale de CHOOZ B1 B2-Examen des Salissures biologiques- Rapport de synthèse", *Rapport LABORELEC CO3-800-95-005F/LDU/RVM, 22/03/05*.
 - "CHOOZ B - Essais sur poste pilote. Conditionnement des eaux de réfrigération", *Rapport LABORELEC CO3/06578 - 1, 15/01/1991*.
 - "Eaux de réfrigération: Centrale de Seraing-Résultats des essais en station pilote", *Rapport Laborelec SER/ER/LD-CO3, 04/11/92*.
 - "Eaux de réfrigération: Centrale de Drogenbos-Résultats des essais en station pilote", *Rapport Laborelec DROG/ER/LD-CO3, novembre 91*.
 - L.C. Neale, "Cooling Problems of Thermal Power Plants - Physical Model Studies", *École d'Été de mécanique des fluides*, 159-180, 6-10 October 1975.
 - J.P. Benque, "Modèles mathématiques des rejets thermiques", *École d'Été de mécanique des fluides*, 184-200, 6-10 octobre 1975.
 - J. Smitz, "Pégase-Planification et gestion de l'assainissement des eaux", *Ministère de la Région Wallonne, Rapport de Synthèse*, 1991.
 - Ernst, Winkler, "Flow Patterns of Cooling Tower Plumes in the near atmosphere Results from a mathematical model", *9th Cooling Tower and Spraying Pond Symposium - International Association for Hydraulic Research, Institut von Karman*, 20-23 September 1994.
 - , "Cycle Chemistry Guidelines for Fossil Plants: All Volatile Treatment", *EPRI, TR-105041*, April 1996.

- Mortensen, Conley, "Film Fill Fouling in Counterflow Cooling Towers: Mechanism and Design", Cooling Tower Institute, Paper TP94-05, Houston, February 13-16, 1994.
- Montjoie, Noble, Mirsky, "Research of Fouling Film", Cooling Tower Institute, New Orleans, February 17-19, 1993.
- Duvivier, van Damme, Bolsée, "Le choix des corps d'échange des tours de réfrigération et leur influence sur les phénomènes d'entartrage par le carbonate de calcium", Proceedings Journées Information Eaux, Vol. 1, 371-3711, 18-10 septembre 1996.
- Dedieu, "Etude expérimentale de l'entartrage des corps d'échange de réfrigérants industriels", Thèse de doctorat INSA Toulouse, 05/06/97.
- J.P. Fesson, "Le primage et la séparation dans les réfrigérants", École d'Été de mécanique des fluides, 202-215, 6-10 octobre 1975.
- G. Ribier, "Optimisation dans le calcul thermique et la détermination d'un réfrigérant atmosphérique à tirage naturel"; École d'Été de mécanique des fluides, 217-229, 6-10 octobre 1975.
- Manoha, Lepage, Pechon, "Le Modèle TELEMAT-3D pour les écoulements tridimensionnels: de nouvelles perspectives pour les études d'environnement", Hydroécologie Appliquée, Tome 4, Vol. 1, 13-20, 1992.
- Nagel, "New Developments in Air-Cooled Steam Condensers and Dry cooling Towers", 9th Cooling Tower and Spraying Pond Symposium - International Association for Hydraulic Research, Institut von Karman, 20-23 September 1994.
- van der Spek, "Advanced Low Noise Cooling Fan", 9th Cooling Tower and Spraying Pond Symposium - International Association for Hydraulic Research, Institut von Karman, 20-23 September 1994.
- Kosten, Wyndrum, Wet, Dry and Hybrid Systems - A Comparison of the Thermal Performance", EPRI - Conference on Cooling Towers and Advanced Cooling Systems, St Petersburg, August 3, 1994.
- Burns, Nicholson, Annett, Alexander, "The Impacts of Retrofitting Cooling Towers at a Large Power Station", EPRI - Conference on Cooling Towers and Advanced Cooling Systems, St Petersburg, August 3, 1994.
- Lindahl, Jameson, "Plume Abatement and Water Conservation with the Wet/Dry cooling Tower", EPRI - Conference on Cooling Towers and Advanced Cooling Systems, St Petersburg, August 3, 1994.
- Gill et al. "A Mechanistic Approach to the Development of Chemical Solutions for Fouling of Cooling Tower Film Fills", EPRI - Conference on Cooling Towers and Advanced Cooling Systems, St Petersburg, August 3, 1994.
- J.F. Commaille, "Perturbations apportées par le rejet de produits tartrifuges dans les rivières sur les traitements physico-chimiques ultérieurs de ces eaux", Thèse de doctorat, INSA Toulouse, 25 octobre 1982.
- L. Duvivier, "Elimination des tartrifuges avant rejet. Conséquences industrielles", Tribune du Cebedeau, n° 487-488, 37, 247-252, 1984.
- "Zebra Mussel Monitoring and Control Guide", EPRI TR-101782, December 1992.

-
- Leyen et al., "Mitigation of Macrofouling: A Comparative Study of Ozone and on Organic Filminducing Polymer", 7th International Zebra Mussel and Aquatic Nuisance Species Conference, New Orleans, January 28-31, 1997.
 - Duvivier et al., "Do we need Chlorine for Water Treatment?", Proceedings Power-Gen '96 Europe, Vol. 1, 757-770, June 96.
 - Duvivier et al., "Fighting Zebra Mussel Fouling with Ozone", EPRI-Service Water System Reliability Improvement Seminar, Daytona Beach, June 25-27, 1996.
 - K. D'Hondt, "On-line Analyse van de "Kritische pH", Applitek, Vergadering Scheikunde, Laborelec, 28/04/93.
 - Lin et al., "Surveillance de la menace d'entartrage du circuit de refroidissement d'une centrale nucléaire par un capteur électrochimique automatique", Proceedings Journées Information Eaux, Vol. 1, 331-3316, 18-20 septembre 1996.
 - G.J. Licina, "Monitoring Corrosion and Biofilm Formation in the Emergency Service Water System at Susquehanna", EPRI-Service Water System Reliability Improvement Seminar, Daytona Beach, June 25-27, 1996.
 - L. Caudron, "Les réfrigérants atmosphériques industriels", Collection de la Direction des Etudes et Recherches d'Electricité de France, 1991.
 - Y. Coeffe, P-M. Clique, B. Manoha, "Thermal Impact Studies for French Coastal Nuclear Sites", 18th ICCE. Cape town, pp 2342-2356, 1982.
 - M. Darras, J. Montfort, J.F. Parent, "Ouvrages de prise et de rejet d'eau, conception et réalisation. A. The Dilution of Heated Discharges of Power Plants. B. Seashore Power Stations and Protection of the Marine Environment", Rapport EDF DER HE/ 42/85.18, 1985.
 - F. Bordet, "Conception des ouvrages d'eau des centrales nucléaires littorales", Rapport EDF DE E-3011, 1983.
 - B. Manoha, "Three-dimensional numeric Modelling of Thermal impact for Gravelines Nuclear Power Plant", 23rd IAHR Congres. Ottawa, 1989.
 - A. Gilbert, R. Gras, D. Roul, "Numeric Computation of Natural River Temperatures", International Conference on Water Quality Modelling in the Inland Natural Environment. Bornemouth England, paper M1, pp. 457-472, 10-13 June 1986.
 - A.W.H. Tumpenny, T.E. Langford, R.J. Aston, "Power Stations and Fish", CEGB Research, pp. 27-39, April 1985.
 - F. Travade, "Aspiration d'organismes aux prises d'eau des centrales", Revue générale nucléaire, n°1, pp. 59-62, 1987.
 - EDF International, "Cordemais Coal-Fired Power Station. Units 4 and 5. Environmental Impact Study", 1987.
 - J.W. Whitehouse, M. Khalanski, M. Saroglia, "Marine Macrofouling Control Experience in the UK with an overview of European Practices", Proceedings of the Symposium on Condenser Macrofouling Control Technologies, Hyannis, Mass. EPRI report CS 3343, pp. 17.1-17.16, Dec., 1983.

- J.W. Whitehouse, M. Khalanski, M. Saroglia, H.A. Jenner, "The Control of Biofouling in Marine and Estuarine Power Stations", Joint report of CEGB, EDF, ENEL and KEMA, 48 pp., 1985.
- M. Khalanski, G. Aprosi, F. Travade, "Biofouling Control in Power Station Circuits. Overview of Electricité de France's experience", Condenser Biofouling Control Symposium; the State of the Art, EPRI Meeting, Lake Buena Vista, Florida, 1985.
- M. Khalanski et Ph. Lutz, "La chloration de l'eau de réfrigération", Revue Générale Nucléaire, n°1, pp. 52-58, 1987.
- NCASI, "Naturally occurring Organohalogen Compounds - A Survey", Technical Bulletin, n°629, 1992.
- H. Palm, R. Lammi, "Fate of Pulp Mill Organochlorines in the Gulf of Bothnia Sediments", Environmental Science and Technology, 29, pp. 1722-1727, 1995.
- H. Kankaanpää, J. Tossari, "Background Levels of EOX and AOX in Sediments of the Gulf of Finland. Molecular Weight Distribution of EOX in Sediments", Chemosphere, 28, pp. 99-116, 1994.
- 3 G. Asplund, "The Origin of Organohalogenes found in the Environment", Linköping Studies in Arts and Science, n° 77, Linköping University, Sweden, 1992.
- Ph. Gosse, M. Khalanski, "La modelisation numerique appliquee a l'évaluation d'impact hydrobiologique", Revue Generale Nucleaire, n° 1, pp. 46-51, 1987.
- M.J. Saleçon, J.M. Thébault, "Modélisation d'écosystème lacustre" Masson, ISBN 2-225-85627-3, 1997.
- G. Aprosi, C. Nepveu de Villemarceau, "French operational Experience of fouling Problems (Algae, Bryozoa) in cooling Towers", 6th IAHR Cooling Tower Workshop, Pisa, Oct. 4-7, 1988.
- J.C. Moretteau, M. Khalanski, "Settling and Growth of *D. polymorpha* in raw Water Circuits of the Cattenom Nuclear Power Plant (Moselle, France)", Proceedings: Fourth International Mussel Conference, Madison, EPRI Report, March 1994.
- M. Khalanski; "Zebra Mussel and other invasive Species in cooling Water Circuits of French Power Stations on Rivers", Seventh International Zebra Mussel and Aquatic Nuisance Species Conference, New-Orleans, 28-31 Jan. 1997.
- H.A. Jenner, J. Whitehouse, C. Taylor, M. Khalanski, "Cooling Water Management in European Power Stations", to be published in Hydroécologie Appliquée.
- B. Comby, "Un écologiste pour le nucléaire", La compagnie du livre, ISBN 2-84155-035-4, 1994.
- VGB-Richtlinie für die Planung von Kühlturmanlagen, R 135 P, 1997.
- VGB-Richtlinie „Empfehlung für den Winterbetrieb von Kraftwerks-Naßkühltürmen“, R 129 P, 1988
- VGB-Richtlinie „Einsatz von Holz im Kühlturbau“, R 611 U, 1996
- DIN 1947: Wärmetechnische Abnahmemessungen an Naßkühltürmen.

- VGB-Richtlinie: "BTR Bautechnik bei Kühltürmen", R 610 U, 1997.
- VGB-"Kühlwasser-Richtlinie", R 455 P, 1990.
- VGB-Merkblatt "Aufbereitung von Betriebswasser und Kühlturm-Zusatzwasser durch Entcarbonisierung bzw. Flockung und Entcarbonisierung", M 403 G, 1992.
- VGB-Fachbuch: Bautechnik in Wärmekraftwerken, B 009, 1993.
- Tesche, W.; Planerische Berücksichtigung von Rezirkulation bei Zellenkühltürmen in Reihenanzordnung. VGB-TB 110, VGB-Kraftwerkstechnik GmbH, Essen (1996).
- VDI-Wärmeatlas: Berechnung von Rückkühlwerken.
- Held: Kühlwasser-Verfahrenstechnik und chemische Methoden für die Kühlwasserbehandlung in Industrie und Kraftwerken, Vulkan-Verlag, Essen (1994).
- DIN EN 45 531: Bestellrichtlinien Turbinenhilfseinrichtungen, Trockenkühlturm.
- DIN EN 45 532: Bestellrichtlinien Turbinenhilfseinrichtungen, Naßkühlturm.
- VDI 3734 B12: Emissionswerte technischer Schallquellen; Rückkühlanlagen; Kühltürme, 1990.
- Abwärme-Auswirkungen, Verminderung, Nutzen. Bericht 82-3 der Abwärmekommission 1982.
- Auswirkungen von Kühltürmen. Bericht 82-1 der Abwärmekommission, 1982.
- Ernst, Wurz: Naturzug-Naßkühlturm des Kernkraftwerks Philippsburg (Block 1). Untersuchungen des Betriebsverhaltens der Emissionen und der Schwadenausbreitung. Fortschritt-Bericht R. 15, Nr. 25 der VDI-Zeitschriften, 1983.
- Ernst Schnabel: Naturzug-Naßkühlturm des Kernkraftwerkes Philippsburg (Block 1). Ergebnisse der Schwadenausbreitungsrechnungen. Fortschritt-Berichte R. 15 Nr. 30 der VDI-Zeitschriften, 1984.
- Baer et al.: Thermodynamische Untersuchungen am Naturzug-Naßkühlturm des Kraftwerks Neurath und Modelle für das Betriebsverhalten und die Schwadenausbreitung, Fortschritt-Berichte R. 15 Nr. 7 der VDI-Zeitschriften.

XII.11 Illustrations

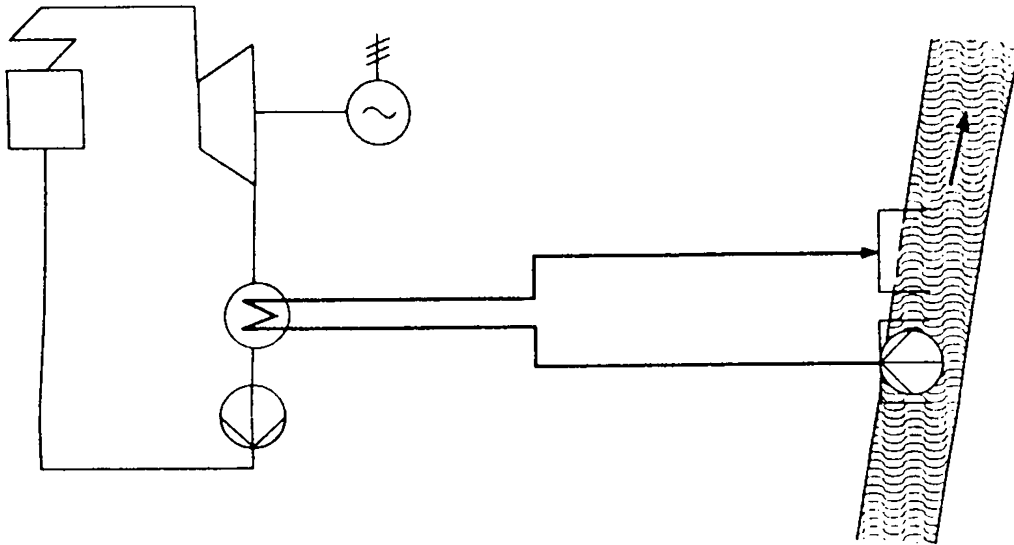
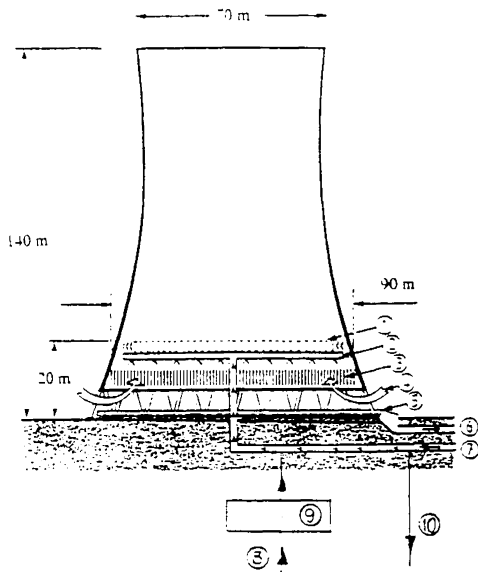

Figure XII.1: Once-through system



Wet cooling tower:

- 1 drift eliminator
- 2 water distribution
- 3 film pack
- 4 air inlet
- 5 water outlet

Once through cooling with cooling tower

- 6 to aquatic environment
- 7 from aquatic environment through condenser to cooling tower
- 8, 9, 10 not existent

Recirculating cooling

- 6 to condenser
- 7 from condenser
- 8 from aquatic environment
- 9 water treatment
- 10 to aquatic environment

Figure XII.2: Wet cooling tower

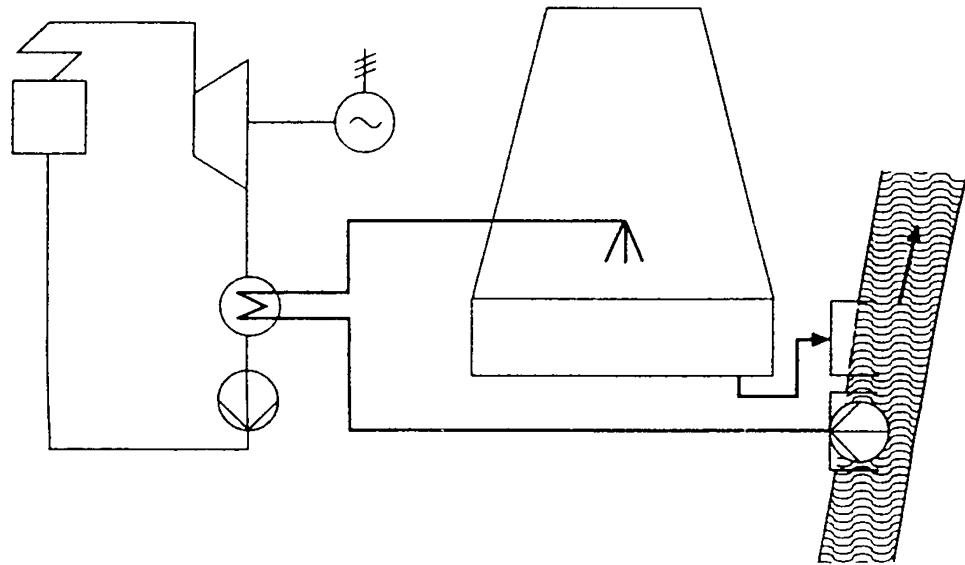

Figure XII.3: Once - through cooling with cooling tower

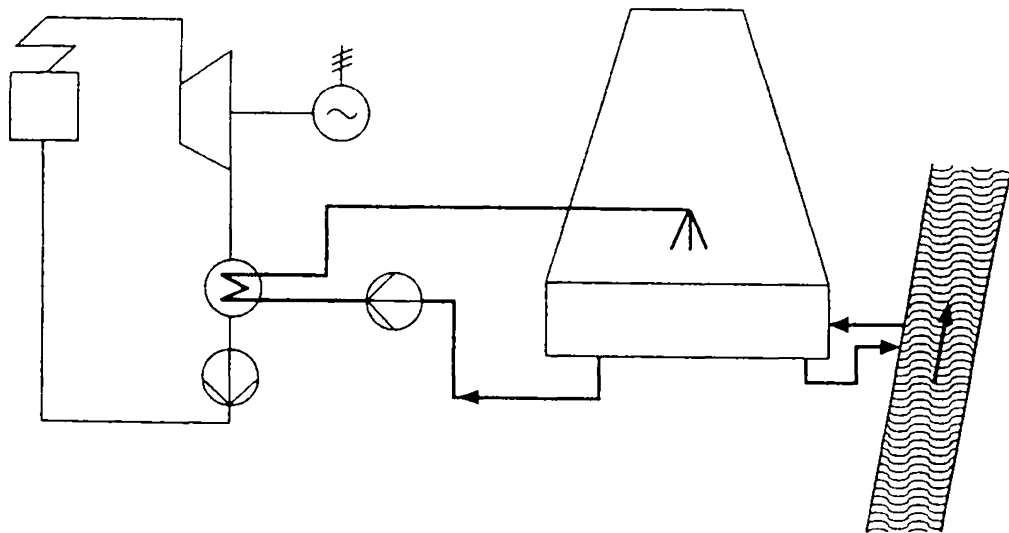

Figure XII.4: Recirculating cooling

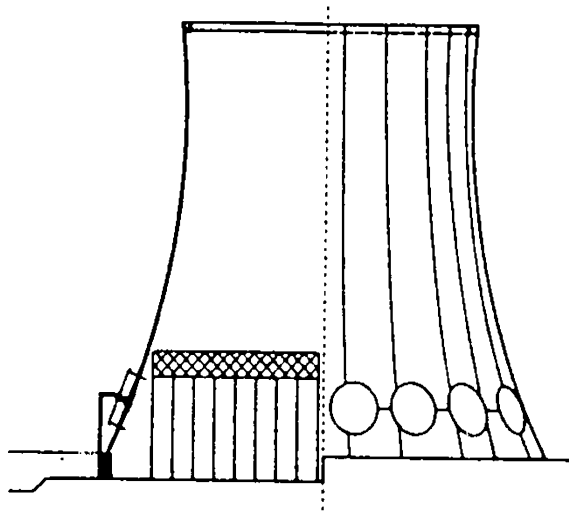

Figure XII.5: Mechanical draught cooling tower (pressure fans)

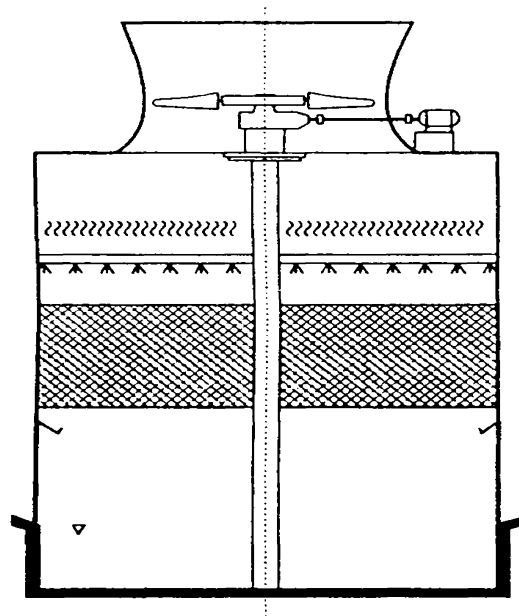

Figure XII.6: Mechanical draught cooling tower (suction fans, cell construction)

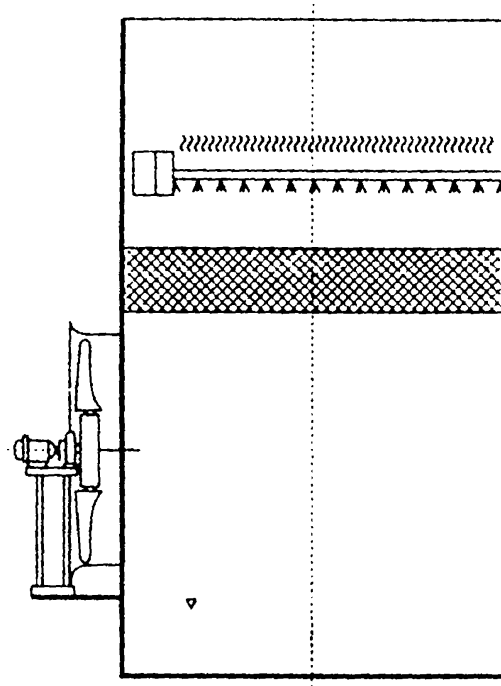

Figure XII.7: Mechanical draught cooling tower (pressure fans, cell construction)

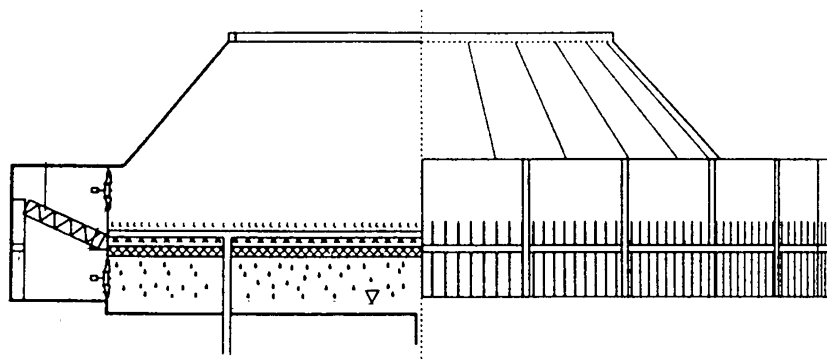

Figure XII.8: Hybrid cooling tower

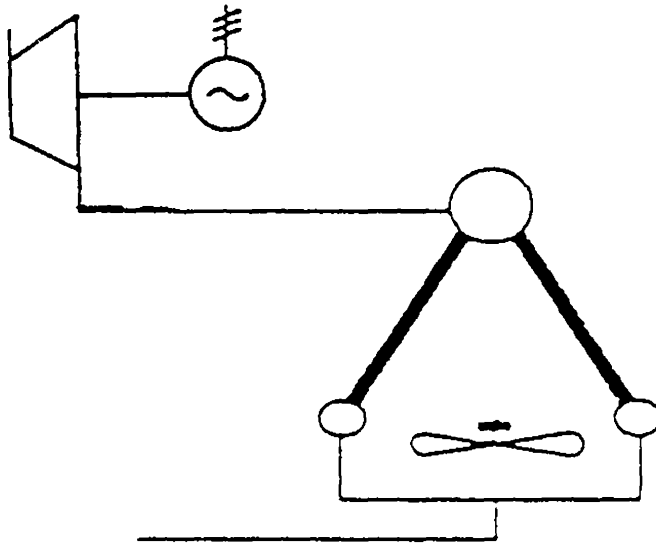

Figure XII.9: Forced draught air-cooled condenser

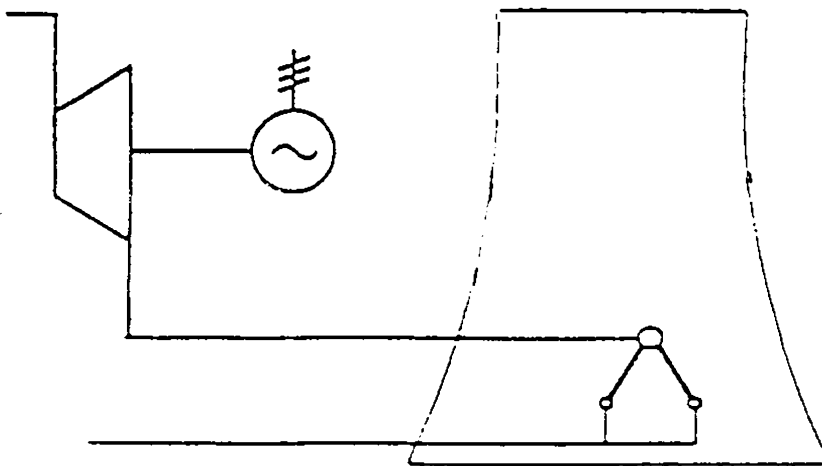

Figure XII.10: Natural draught air-cooled condenser

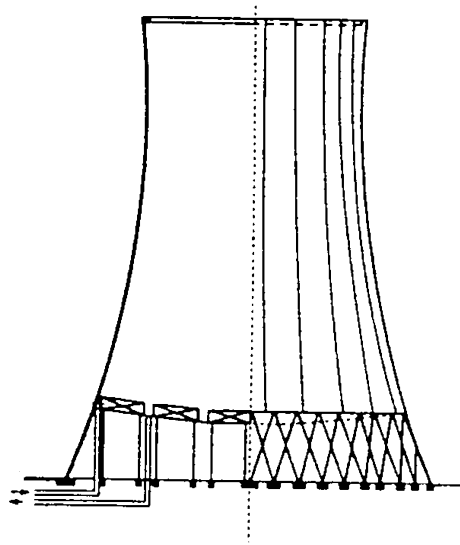

Figure XII.11: Closed recirculating indirect dry cooling tower

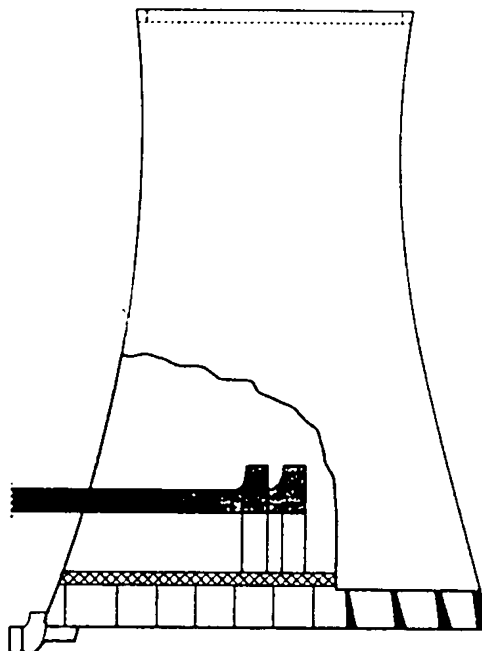

Figure XII.12: Cooling tower with discharge of cleaned flue gas

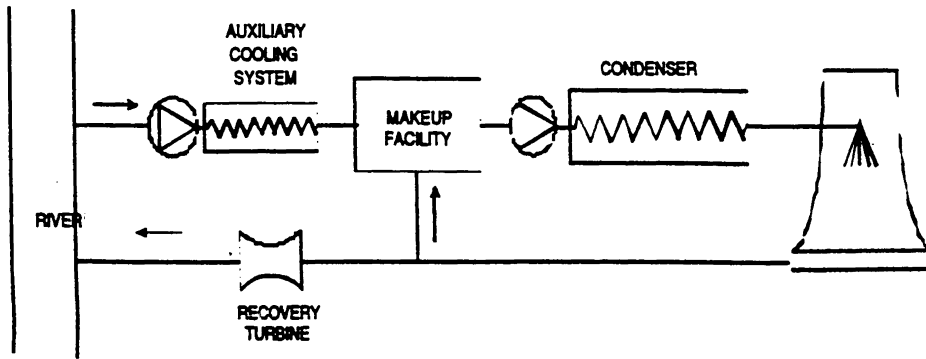

Figure XII.13: Cooling system with fixed concentration factor

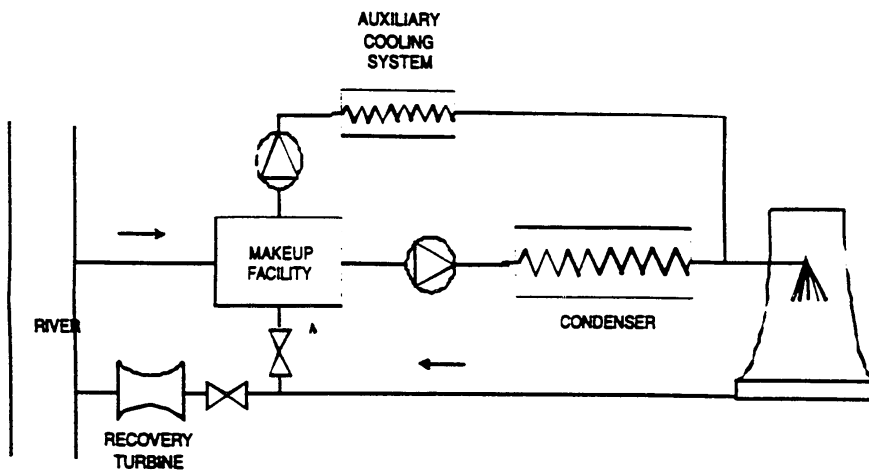

Figure XII.14: Cooling system with sliding concentration factor

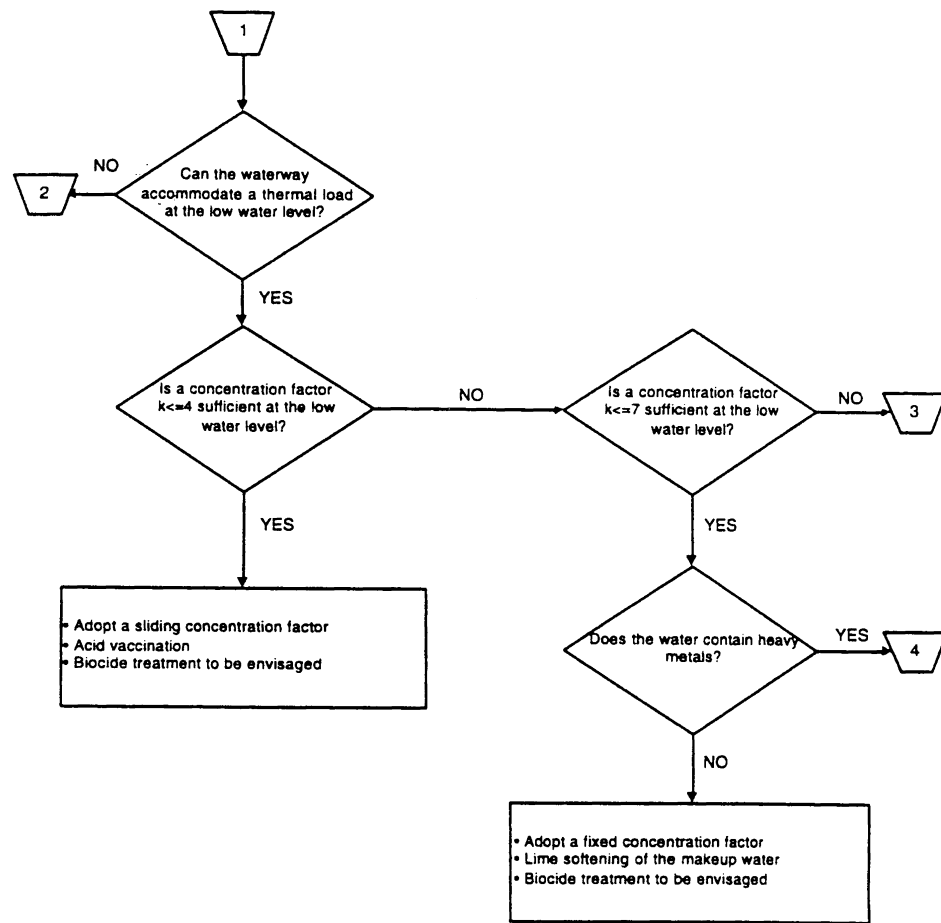

Figure XII.15: Decision-making logic diagram for the choice of the cooling system