

# Best Available Techniques (BAT) Reference Document for the Production of Cement, Lime and Magnesium Oxide

Industrial Emissions Directive 2010/75/EU  
(Integrated Pollution Prevention and Control)

JOINT RESEARCH CENTRE  
Institute for Prospective Technological Studies  
Sustainable Production and Consumption Unit  
European IPPC Bureau

## Colour code:

Black: text from the existing CLM BREF

Red: indicates text that was added for the  
adaptation of the CLM BREF to the provisions of  
the IED

**Draft CLM BREF (June 2012)**



---

WORKING DRAFT IN PROGRESS

---

This document is one from the series of **foreseen** documents as listed below (at the time of writing, not all documents have been drafted):

<b>Reference Document on Best Available Techniques</b>	<b>Code</b>
Ceramic Manufacturing Industry	CER
Common Waste Water and Waste Gas Treatment/Management Systems in the Chemical Sector	CWW
Emissions from Storage	EFS
Energy Efficiency	ENE
Ferrous Metals Processing Industry	FMP
Food, Drink and Milk Industries	FDM
Industrial Cooling Systems	ICS
Intensive Rearing of Poultry and Pigs	IRPP
Iron and Steel <b>Production</b>	IS
Large Combustion Plants	LCP
Large Volume Inorganic Chemicals – Ammonia, Acids and Fertilisers Industries	LVIC-AAF
Large Volume Inorganic Chemicals – Solid and Others industry	LVIC-S
Large Volume Organic Chemical Industry	LVOC
Management of Tailings and Waste-Rock in Mining Activities	MTWR
<b>Manufacture of Glass</b>	GLS
Manufacture of Organic Fine Chemicals	OFC
Non Ferrous Metals Industries	NFM
<i><b>Production of Cement, Lime and Magnesium Oxide Manufacturing</b></i>	<i>CLM</i>
<b>Production of Chlor-Alkali</b>	CAK
Production of Polymers	POL
<b>Production of Pulp, Paper and Board</b>	PP
Production of Speciality Inorganic Chemicals	SIC
<b>Refining of Mineral Oil and Gas</b>	REF
Slaughterhouses and Animals By-products Industries	SA
Smitheries and Foundries Industry	SF
Surface Treatment of Metals and Plastics	STM
Surface Treatment Using Organic Solvents	STS
Tanning of Hides and Skins	TAN
Textiles Industry	TXT
Waste Incineration	WI
Waste Treatments Industries	WT
<b>Wood and Wood Products Preservation with Chemicals</b>	<b>WPC</b>
<b>Wood-based Panels Production</b>	<b>WBP</b>
<b>Reference Document</b>	
Economics and Cross-Media Effects	ECM
General Principles of Monitoring	MON

Electronic versions of draft and finalised documents are publicly available and can be downloaded from <http://eippcb.jrc.ec.europa.eu>.

**\*\* NOTE to Article 13 Forum members: Executive summary has been deleted according to the new standards for BREFs under the IED\*\***

WORKING DRAFT IN PROGRESS

## PREFACE

**\*\* NOTE to Article 13 Forum members: Old Preface text has been deleted and replaced with the new standard text with some modifications in order to reflect the situation of the CLM BREF\*\***

### 1. Status of this document

Unless otherwise stated, references to 'the Directive' in this document refer to Directive 2010/75/EU of the European Parliament and the Council on industrial emissions (integrated pollution prevention and control) (Recast).

This document is a working draft of the European IPPC Bureau (of the Commission's Joint Research Centre). It is not an official publication of the European Union and does not necessarily reflect the position of the European Commission.

### 2. Participants in the information exchange

As required in Article 13(3) of the Directive, the Commission has established a forum to promote the exchange of information, which is composed of representatives from Member States, the industries concerned and non-governmental organisations promoting environmental protection (Commission Decision of 16 May 2011 establishing a forum for the exchange of information pursuant to Article 13 of the Directive 2010/75/EU on industrial emissions (2011/C 146/03), OJ C 146, 17.05.2011, p. 3).

Forum members have nominated technical experts constituting the technical working group (TWG) that was the main source of information for transforming BAT sections of the CLM BREF to BAT conclusions for use under IED. The work of the TWG was led by the European IPPC Bureau (of the Commission's Joint Research Centre).

### 3. Structure and contents of this document

This document contains three main chapters: Chapter 1 – Cement industry, Chapter 2 – Lime industry and Chapter 3 – Magnesium oxide industry by using the dry process route.

Sections 1 and 2 of Chapters 1 – 3 provide general information on the industrial sector concerned and on the industrial processes and techniques used within this sector.

Section 3 of Chapters 1 – 3 provides data and information concerning the environmental performance of installations within the sector in terms of current emissions, consumption and nature of raw materials, water consumption, use of energy and the generation of waste reflecting the situation in installations in operation at the time of writing.

Section 4 of Chapters 1 – 3 describes in more detail the techniques to prevent or, where this is not practicable, to reduce the environmental impact of operating installations in this sector that were considered in determining the BAT conclusions. This information includes, where relevant, the environmental performance levels (e.g. emission and consumption levels) which can be achieved by using the techniques, the associated monitoring and the costs and the cross-media issues associated with the techniques.

Section 5 of Chapters 1 – 3 presents information on 'emerging techniques' as defined in Article 3(14) of the Directive.

Chapter 4 presents the BAT conclusions as defined in Article 3(12) of the Directive.

Concluding remarks and recommendations for future work are presented in Chapter 5.

#### **4. Information sources and the derivation of BAT**

This document is based on information collected from a number of sources, in particular through the TWG that was established specifically for the exchange of information under Article 13 of the Directive. The information has been collated and assessed by the European IPPC Bureau (of the Commission's Joint Research Centre) who led the work on determining BAT, guided by the principles of technical expertise, transparency and neutrality. The work of the TWG and all other contributors is gratefully acknowledged.

The BAT conclusions have been established through an iterative process involving the following steps:

- identification of the key environmental issues for the sector;
- examination of the techniques most relevant to address these key issues;
- identification of the best environmental performance levels, on the basis of the available data in the European Union and worldwide;
- examination of the conditions under which these environmental performance levels were achieved, such as costs, cross-media effects, and the main driving forces involved in the implementation of the techniques;
- selection of the best available techniques (BAT), their associated emission levels (and other environmental performance levels) and the associated monitoring for this sector according to Article 3(10) of, and Annex III to, the Directive.

Expert judgement by the European IPPC Bureau and the TWG has played a key role in each of these steps and the way in which the information is presented here.

Where available, economic data have been given together with the descriptions of the techniques presented in Section 4 of Chapters 1 – 3. These data give a rough indication of the magnitude of the costs and benefits. However, the actual costs and benefits of applying a technique may depend strongly on the specific situation of the installation concerned, which cannot be evaluated fully in this document. In the absence of data concerning costs, conclusions on the economic viability of techniques are drawn from observations on existing installations.

#### **5. Review of BAT reference documents (BREFs)**

BAT is a dynamic concept and so the review of BREFs is a continuing process. For example, new measures and techniques may emerge, science and technologies are continuously developing and new or emerging processes are being successfully introduced into the industries. In order to reflect such changes and their consequences for BAT, this document will be periodically reviewed and, if necessary, updated accordingly.

#### **6. Contact information**

All comments and suggestions should be made to the European IPPC Bureau at the Institute for Prospective Technological Studies at the following address:

European Commission  
Institute for Prospective Technological Studies  
European IPPC Bureau  
Edificio Expo  
c/ Inca Garcilaso, 3  
E-41092 Seville, Spain  
Telephone: +34 95 4488 284  
Fax: +34 95 4488 426  
E-mail: [JRC-IPTS-EIPPCB@ec.europa.eu](mailto:JRC-IPTS-EIPPCB@ec.europa.eu)  
Internet: <http://eippcb.jrc.ec.europa.eu>

# Best Available Techniques Reference Document for the Production of Cement, Lime and Magnesium Oxide

PREFACE.....	I
SCOPE .....	XIX
<b>1 CEMENT INDUSTRY .....</b>	<b>1</b>
1.1 General information about the cement industry.....	1
1.2 Applied processes and techniques in cement manufacturing.....	9
1.2.1 Raw materials and their winning.....	11
1.2.2 Raw materials – storage and preparation .....	13
1.2.2.1 Storage of raw materials.....	13
1.2.2.2 Grinding of raw materials .....	13
1.2.2.2.1 Grinding of raw materials – dry and semi-dry kiln systems.....	14
1.2.2.2.2 Grinding of raw materials – wet or semi-wet kiln systems.....	14
1.2.2.2.3 Raw meal or slurry homogenisation and storage.....	15
1.2.3 Fuels – storage and preparation.....	15
1.2.3.1 Storage of conventional fuels.....	16
1.2.3.2 Preparation of conventional fuels.....	16
1.2.4 Use of waste .....	17
1.2.4.1 General aspects.....	17
1.2.4.2 Use of wastes as raw materials.....	19
1.2.4.3 Use of wastes as fuels .....	22
1.2.4.3.1 Types of waste fuels.....	22
1.2.4.3.1.1 Solid waste fuels.....	23
1.2.4.3.1.2 Liquid waste fuels .....	24
1.2.4.3.2 Quality requirements of waste and input control.....	24
1.2.4.3.2.1 Metal concentrations of wastes.....	26
1.2.4.3.3 Storage and handling of waste.....	26
1.2.5 Clinker burning .....	26
1.2.5.1 Kiln firing.....	28
1.2.5.2 Long rotary kilns.....	29
1.2.5.3 Rotary kilns equipped with preheaters .....	29
1.2.5.3.1 Grate preheater technique.....	29
1.2.5.3.2 Suspension preheater technique .....	30
1.2.5.3.3 Shaft preheaters.....	31
1.2.5.3.4 Four stage cyclone preheater.....	31
1.2.5.4 Rotary kilns with preheater and precalciner.....	31
1.2.5.4.1 Bypass systems.....	33
1.2.5.5 Shaft kilns .....	34
1.2.5.6 Kiln exhaust gases.....	34
1.2.5.6.1 CO trips.....	34
1.2.5.7 Clinker coolers .....	35
1.2.5.7.1 Rotary coolers .....	35
1.2.5.7.1.1 Tube coolers .....	35
1.2.5.7.1.2 Planetary (or satellite) coolers.....	35
1.2.5.7.2 Grate coolers .....	36
1.2.5.7.2.1 Travelling grate coolers.....	36
1.2.5.7.2.2 Reciprocating grate coolers.....	36
1.2.5.7.2.3 Third generation of grate coolers.....	37
1.2.5.7.3 Vertical coolers .....	37
1.2.5.8 Cogeneration .....	38
1.2.6 Cement grinding and storage .....	38
1.2.6.1 Clinker storage .....	38
1.2.6.2 Cement grinding.....	39
1.2.6.2.1 Metering and proportioning of the mill feed .....	39
1.2.6.2.2 Grinding of cement.....	39
1.2.6.2.3 Grinding of mineral additions .....	40
1.2.6.2.4 Separation by particle size distribution .....	41
1.2.6.2.5 Reduction of chromates – chromium (VI).....	41
1.2.6.3 Storage of cement.....	42

1.2.7	Packaging and dispatch .....	42
1.3	Current consumption and emission levels.....	43
1.3.1	Consumption of water .....	44
1.3.2	Consumption of raw materials.....	45
1.3.2.1	Consumption of wastes as raw materials .....	45
1.3.3	Use of energy.....	46
1.3.3.1	Thermal energy demand .....	46
1.3.3.2	Electrical energy demand.....	48
1.3.3.3	Consumption of waste fuels.....	49
1.3.4	Emissions to air .....	53
1.3.4.1	Dust (particulate matter).....	56
1.3.4.1.1	Channelled dust emissions.....	56
1.3.4.1.2	Fine dust emissions PM <sub>10</sub> and PM <sub>2.5</sub> .....	58
1.3.4.1.3	Diffuse dust emissions .....	60
1.3.4.2	Nitrogen oxides.....	60
1.3.4.3	Sulphur dioxide.....	66
1.3.4.4	Carbon oxides (CO <sub>2</sub> , CO) .....	69
1.3.4.4.1	Carbon dioxide (CO <sub>2</sub> ) .....	69
1.3.4.4.2	Carbon monoxide (CO) .....	70
1.3.4.5	Total organic compounds (TOC).....	71
1.3.4.6	Polychlorinated dibenzo-p-dioxins (PCDD) and dibenzofurans (PCDF) .....	73
1.3.4.7	Metals and their compounds .....	76
1.3.4.7.1	Mercury.....	81
1.3.4.8	Hydrogen chloride and hydrogen fluoride (HCl and HF).....	83
1.3.4.8.1	Gaseous inorganic chlorine compounds .....	83
1.3.4.8.2	Gaseous inorganic fluorine compounds.....	86
1.3.4.9	Ammonia (NH <sub>3</sub> ).....	89
1.3.4.10	Benzene, toluene, ethylbenzene and xylene (BTEX).....	91
1.3.4.11	Polyaromatic hydrocarbons (PAH).....	91
1.3.4.12	Other organic pollutants .....	91
1.3.4.13	Impacts on emissions behaviour and energy efficiency by using waste materials.....	92
1.3.4.14	Impacts on product quality by using wastes .....	93
1.3.5	Process losses/waste .....	93
1.3.6	Emissions to water.....	94
1.3.7	Noise.....	94
1.3.8	Odours .....	95
1.3.9	Monitoring.....	95
1.3.9.1	Monitoring of parameters and emissions.....	95
1.4	Techniques to consider in the determination of BAT .....	97
1.4.1	Consumption of raw materials.....	99
1.4.2	Reduction of energy consumption (energy efficiency).....	99
1.4.2.1	Reduction of thermal energy use .....	99
1.4.2.1.1	Kiln systems.....	100
1.4.2.1.2	Raw material properties .....	102
1.4.2.1.3	Fuel properties .....	103
1.4.2.1.4	Gas bypass system .....	104
1.4.2.1.5	Reduction of the clinker content of cement products.....	105
1.4.2.2	Reduction of electrical energy use.....	105
1.4.2.3	Process selection.....	106
1.4.2.4	Energy recovery from kilns and coolers/cogeneration.....	107
1.4.3	General techniques .....	109
1.4.3.1	Process control optimisation.....	109
1.4.3.2	Choice of fuels and raw materials.....	111
1.4.3.3	Use of wastes as fuels .....	112
1.4.4	Emissions of dust (particulate matter) .....	113
1.4.4.1	Techniques for dusty operations .....	114
1.4.4.2	Techniques for bulk storage areas and stockpiles.....	115
1.4.4.3	Reduction of channelled dust emissions.....	116
1.4.4.3.1	Electrostatic precipitators (ESPs) .....	117
1.4.4.3.2	Fabric filters.....	119
1.4.4.3.3	Hybrid filters.....	124
1.4.5	Gaseous compounds .....	125
1.4.5.1	Reduction of NO <sub>x</sub> emissions.....	125



1.4.5.1.1	Flame cooling .....	128
1.4.5.1.2	Low NO <sub>x</sub> burners .....	129
1.4.5.1.3	Staged combustion .....	130
1.4.5.1.4	Mid-kiln firing .....	132
1.4.5.1.5	Mineralised clinker .....	133
1.4.5.1.6	Process optimisation (NO <sub>x</sub> ) .....	133
1.4.5.1.7	Selective non-catalytic reduction (SNCR) .....	134
1.4.5.1.8	Selective catalytic reduction (SCR) .....	140
1.4.5.2	Reduction of SO <sub>2</sub> emissions .....	143
1.4.5.2.1	Absorbent addition .....	145
1.4.5.2.2	Wet scrubber .....	146
1.4.5.2.3	Activated carbon .....	148
1.4.5.3	Reduction of carbon oxides (CO) emissions and CO trips .....	149
1.4.5.4	Reduction of total organic carbon emissions (TOC) .....	152
1.4.5.5	Reduction of hydrogen chloride (HCl) and hydrogen fluoride (HF) .....	153
1.4.6	Reduction of polychlorinated dibenzo-p-dioxin (PCDD) and polychlorinated dibenzofuran (PCDF) emissions .....	154
1.4.7	Reduction of metal emissions .....	155
1.4.8	Examples of cost data for different flue-gas abatement techniques and primary techniques which can be used for emissions reductions .....	156
1.4.8.1	Example cost data for dust abatement techniques .....	156
1.4.8.2	Example cost data for NO <sub>x</sub> abatement techniques .....	158
1.4.8.3	Example cost data for SO <sub>x</sub> abatement techniques .....	160
1.4.9	Process losses/waste .....	162
1.4.10	Noise .....	163
1.4.11	General considerations for odours .....	164
1.4.12	Environmental management tools .....	164
1.5	Emerging techniques in the cement industry .....	168
1.5.1	Fluidised bed cement manufacturing technique .....	168
1.5.2	Staged combustion combined with SNCR .....	169
1.5.3	Cement kiln flue-gas treatment with dry sodium bicarbonate and chemical re-use .....	169
<b>2</b>	<b>LIME INDUSTRY .....</b>	<b>173</b>
2.1	General information about the lime industry .....	173
2.1.1	Lime and its application .....	173
2.1.2	World lime production .....	174
2.1.3	Geographical distribution and general economic considerations in Europe – principal indicators .....	174
2.1.3.1	Annual production .....	174
2.1.3.2	Key environmental and sustainable development issues .....	175
2.1.3.3	Type of lime and dolomitic lime .....	176
2.1.3.4	Lime Installations .....	177
2.2	Applied processes and techniques in lime manufacturing .....	182
2.2.1	General production process description .....	183
2.2.2	Raw materials and winning of limestone .....	184
2.2.3	Limestone preparation, cleaning and storage .....	185
2.2.3.1	Limestone preparation .....	185
2.2.3.2	Limestone storage .....	186
2.2.3.3	Limestone washing .....	186
2.2.4	Fuels – preparation and storage .....	187
2.2.5	Use of waste .....	190
2.2.5.1	General aspects .....	190
2.2.5.2	Technical aspects .....	191
2.2.5.3	Types of waste fuels used .....	193
2.2.5.4	Quality control of solid waste fuels .....	195
2.2.6	Quicklime and dolomite production .....	195
2.2.6.1	Calcination of limestone – chemical reaction .....	195
2.2.6.2	Calcining of limestone in the kiln .....	197
2.2.6.3	Quicklime processing .....	199
2.2.6.3.1	Production of milled ground quicklime .....	199
2.2.6.4	Production of slaked and/or hydrated lime .....	200
2.2.6.4.1	Production of hydrated lime .....	200
2.2.6.4.2	Production of milk of lime and lime putty .....	201

2.2.7	Types of lime kilns – techniques and design .....	201
2.2.7.1	Mixed feed shaft kiln (MFSK).....	204
2.2.7.2	Parallel flow regenerative kiln (PFRK) .....	205
2.2.7.3	Annular shaft kilns (ASK) .....	208
2.2.7.4	Other kilns (OK).....	211
2.2.7.4.1	Other single shaft kilns .....	211
2.2.7.4.2	Double inclined shaft kilns .....	211
2.2.7.4.3	Multi-chamber shaft kilns .....	212
2.2.7.4.4	Travelling grate kilns .....	212
2.2.7.4.5	Top-shaped kilns.....	212
2.2.7.4.6	Gas suspension calcination (GSC) kilns .....	212
2.2.7.4.7	Rotating hearth kilns .....	213
2.2.7.5	Long rotary kilns (LRK).....	213
2.2.7.6	Rotary kilns with preheaters (PRK).....	216
2.2.8	Storage and handling .....	219
2.2.8.1	Storage.....	219
2.2.8.1.1	Storage of quicklime .....	219
2.2.8.1.2	Storage of hydrated lime .....	220
2.2.8.1.3	Storage of milk of lime .....	220
2.2.8.2	Handling .....	221
2.2.9	Other types of lime .....	221
2.2.9.1	Production of hydraulic limes.....	221
2.2.9.2	Production of calcined dolomite .....	221
2.2.9.3	Production of sintered dolime by the double pass process .....	222
2.2.10	General considerations for captive lime kilns.....	222
2.2.10.1	Lime kilns in the iron and steel industry.....	222
2.2.10.2	Lime kilns in the Kraft pulp industry.....	223
2.2.10.3	Lime kilns in the sugar industry .....	223
2.3	Current consumption and emission levels.....	224
2.3.1	Consumption of limestone .....	224
2.3.2	Use of energy.....	224
2.3.2.1	Limestone calcining.....	224
2.3.2.2	Lime hydrating .....	226
2.3.2.3	Lime grinding .....	226
2.3.3	Emissions to air .....	226
2.3.3.1	Dust (PM) .....	228
2.3.3.1.1	Channelled dust emissions .....	228
2.3.3.1.2	Diffuse dust emissions .....	230
2.3.3.2	Nitrogen oxides.....	231
2.3.3.3	Sulphur dioxide.....	232
2.3.3.4	Carbon oxides (CO <sub>x</sub> ).....	235
2.3.3.4.1	Carbon dioxide (CO <sub>2</sub> ) .....	235
2.3.3.4.2	Carbon monoxide (CO) .....	236
2.3.3.5	Organic compounds/total organic carbon (TOC).....	240
2.3.3.6	Polychlorinated dibenzo-p-dioxins (PCDD) and polychlorinated dibenzofurans (PCDF) .....	241
2.3.3.7	Hydrogen chloride and hydrogen fluoride (HCl and HF).....	242
2.3.3.8	Hydrogen sulphide (H <sub>2</sub> S).....	243
2.3.3.9	Metals .....	243
2.3.3.10	Impact on emissions behaviour by using waste materials .....	246
2.3.3.10.1	Emissions examples for the use of waste oil.....	246
2.3.3.10.2	Examples of emissions from the use of solid waste in rotary kilns .....	247
2.3.4	Process losses/waste .....	248
2.3.5	Water use and purification.....	249
2.3.6	Noise.....	249
2.3.7	Odours .....	249
2.3.8	Monitoring.....	250
2.3.8.1	Continuous measurements .....	250
2.3.8.2	Periodic measurements .....	250
2.4	Techniques to consider in the determination of BAT .....	252
2.4.1	Consumption of limestone .....	254
2.4.2	Reduction of energy consumption (energy efficiency).....	254
2.4.3	Process control optimisation.....	256

2.4.4	Choice of fuels (including waste fuels).....	257
2.4.5	Emissions of dust (particulate matter).....	259
2.4.5.1	Techniques for dusty operations.....	259
2.4.5.2	Techniques for bulk storage areas and stockpiles .....	260
2.4.5.3	Reduction of channelled dust emissions .....	261
2.4.5.3.1	Electrostatic precipitators (ESPs).....	262
2.4.5.3.2	Fabric filters .....	264
2.4.5.3.3	Wet dust separators .....	267
2.4.5.3.4	Centrifugal separators/cyclones.....	270
2.4.5.3.5	Examples of cost data for different flue-gas cleaning techniques .....	270
2.4.6	Gaseous compounds.....	274
2.4.6.1	Reduction of NO <sub>x</sub> emissions .....	274
2.4.6.1.1	Process optimisation.....	275
2.4.6.1.2	Air staging .....	276
2.4.6.1.3	Low NO <sub>x</sub> burners .....	277
2.4.6.1.4	Selective non-catalytic reduction (SNCR) .....	278
2.4.6.1.5	Selective catalytic reduction (SCR).....	281
2.4.6.2	Reduction of SO <sub>2</sub> emissions .....	282
2.4.6.3	Reduction of CO emissions.....	283
2.4.6.4	Reduction of total organic carbon emissions (TOC).....	284
2.4.6.5	Reduction of hydrogen chloride (HCl) and hydrogen fluoride (HF).....	284
2.4.7	Reduction of polychlorinated dibenzo-p-dioxins (PCDD) and polychlorinated dibenzofurans (PCDF) emissions.....	285
2.4.8	Reduction of metal emissions .....	288
2.4.9	Process losses/waste.....	289
2.4.9.1	General considerations concerning re-use of solid process losses/waste as raw material.....	289
2.4.10	Noise .....	290
2.4.11	General considerations for odours .....	292
2.4.12	Environmental management tools.....	292
2.5	Emerging techniques in the lime industry .....	293
2.5.1	Fluidised bed calcination .....	293
2.5.2	Flash calciner/suspension preheater .....	293
2.5.3	Ceramic filters.....	294
2.5.4	Post-combustion of flue-gases from mixed feed shaft kilns .....	294
<b>3</b>	<b>MAGNESIUM OXIDE INDUSTRY (DRY PROCESS ROUTE BASED ON MINED NATURAL MAGNESITE) .....</b>	<b>297</b>
3.1	General Information .....	297
3.1.1	Introduction.....	297
3.1.2	The magnesite industry worldwide and in Europe .....	297
3.1.2.1	Types of magnesium oxide (magnesia) products .....	301
3.1.2.1.1	Magnesia .....	301
3.1.2.1.1.1	Sintered/dead burned magnesia (DBM) .....	302
3.1.2.1.1.2	Caustic calcined magnesia (CCM) .....	302
3.1.2.1.1.3	Fused magnesia (FM).....	302
3.1.3	The use of magnesia.....	302
3.2	Applied processes and techniques .....	305
3.2.1	Raw materials and preparation.....	305
3.2.1.1	Magnesite .....	305
3.2.2	Fuels.....	306
3.2.3	General description of the production process of magnesia from magnesite (naturally sintered/dead burned magnesia).....	306
3.2.3.1	Firing processes.....	307
3.2.3.1.1	Direct firing process (single phase firing) .....	307
3.2.3.1.1.1	Preparation of the 'raw sinter' .....	307
3.2.3.1.2	Two phase firing process.....	309
3.2.3.2	Types of kilns – techniques and design.....	310
3.2.3.2.1	Rotary kilns .....	311
3.2.3.2.1.1	Rotary kilns with a preheater.....	311
3.2.3.2.1.2	Long rotary kilns .....	311
3.2.3.2.2	Shaft kilns.....	312
3.2.3.2.2.1	Shaft kilns with a rotating plate.....	312

3.2.3.2.2	Shaft kilns with a rotating grate .....	313
3.2.3.2.3	Double shaft kiln.....	313
3.2.4	Production of fused magnesia.....	314
3.3	Current consumption and emission levels.....	316
3.3.1	Consumption of raw materials (unprocessed magnesite) and water.....	316
3.3.2	Energy consumption.....	317
3.3.3	Emissions.....	318
3.3.3.1	Emissions to air .....	318
3.3.3.2	Process losses/waste .....	319
3.3.3.3	Emissions to water.....	320
3.3.3.4	Noise.....	320
3.3.4	Monitoring.....	320
3.4	Techniques to consider in the determination of BAT .....	322
3.4.1	General considerations concerning consumption of raw materials.....	324
3.4.2	General considerations concerning water .....	324
3.4.3	Reduction of energy consumption (energy efficiency).....	324
3.4.4	Process control optimisation.....	325
3.4.5	Fuel selection.....	326
3.4.6	Emissions of dust (particulate matter) .....	327
3.4.6.1	Techniques for dusty operations .....	327
3.4.6.2	Reduction of channelled dust emissions .....	328
3.4.6.2.1	Electrostatic precipitators (ESPs) .....	329
3.4.6.2.2	Centrifugal separators/cyclones .....	329
3.4.6.2.3	Wet dust separators.....	330
3.4.6.2.4	Fabric filters.....	331
3.4.7	Gaseous compounds .....	332
3.4.7.1	Reduction of NO <sub>x</sub> emissions.....	332
3.4.7.2	Reduction of CO emissions .....	334
3.4.7.3	Reduction of SO <sub>2</sub> emissions .....	335
3.4.8	General considerations concerning process losses/waste .....	336
3.4.9	Noise.....	337
3.4.10	Environmental management tools .....	338
3.5	Emerging techniques.....	339
<b>4</b>	<b>BAT CONCLUSIONS .....</b>	<b>341</b>
	SCOPE.....	341
	DEFINITIONS .....	342
	GENERAL CONSIDERATIONS .....	344
4.1	General BAT conclusions .....	345
4.1.1	Environmental management systems (EMS).....	345
4.1.2	Noise.....	346
4.2	BAT conclusions for the cement industry.....	347
4.2.1	General primary techniques.....	347
4.2.2	Monitoring.....	347
4.2.3	Energy consumption and process selection .....	348
4.2.3.1	Process selection.....	348
4.2.3.2	Energy consumption .....	349
4.2.4	Use of waste .....	350
4.2.4.1	Waste quality control.....	350
4.2.4.2	Waste feeding into the kiln .....	351
4.2.4.3	Safety management for the use of hazardous waste materials .....	351
4.2.5	Dust emissions.....	352
4.2.5.1	Diffuse dust emissions.....	352
4.2.5.2	Channelled dust emissions from dusty operations.....	353
4.2.5.3	Dust emissions from kiln firing processes .....	354
4.2.5.4	Dust emissions from cooling and milling processes .....	354
4.2.6	Gaseous compounds .....	355
4.2.6.1	NO <sub>x</sub> emissions .....	355
4.2.6.2	SO <sub>x</sub> emissions .....	356
4.2.6.3	CO emissions and CO trips.....	357
4.2.6.3.1	Reduction of CO trips .....	357
4.2.6.4	Total organic carbon emissions (TOC).....	358
4.2.6.5	Hydrogen chloride (HCl) and hydrogen fluoride (HF) emissions .....	358

4.2.7	PCDD/F emissions	359
4.2.7.1	Metal emissions	359
4.2.8	Process losses/waste	360
4.3	BAT conclusions for the lime industry	361
4.3.1	General primary techniques	361
4.3.2	Monitoring	362
4.3.3	Energy consumption	363
4.3.4	Consumption of limestone	364
4.3.5	Selection of fuels	364
4.3.5.1	Use of waste fuels	365
4.3.5.1.1	Waste quality control	365
4.3.5.1.2	Waste feeding into the kiln	365
	Safety management for the use of hazardous waste materials	365
4.3.6	Dust emissions	366
4.3.6.1	Diffuse dust emissions	366
4.3.6.2	Channelled dust emissions from dusty operations other than those from kiln firing processes	367
4.3.6.3	Dust emissions from kiln firing processes	367
4.3.7	Gaseous compounds	368
4.3.7.1	Primary techniques for reducing emissions of gaseous compounds	368
4.3.7.2	NO <sub>x</sub> emissions	369
4.3.7.3	SO <sub>x</sub> emissions	370
4.3.7.4	CO emissions and CO trips	371
4.3.7.4.1	CO emissions	371
4.3.7.4.2	Reduction of CO trips	371
4.3.7.5	Total organic carbon emissions (TOC)	372
4.3.7.6	Hydrogen chloride (HCl) and hydrogen fluoride (HF) emissions	373
4.3.8	PCDD/F emissions	373
4.3.9	Metal emissions	374
4.3.10	Process losses/waste	374
4.4	BAT conclusions for the magnesium oxide industry	375
4.4.1	Monitoring	375
4.4.2	Energy consumption	376
4.4.3	Dust emissions	377
4.4.3.1	Diffuse dust emissions	377
4.4.3.2	Channelled dust emissions from dusty operations other than kiln firing processes	377
4.4.3.3	Dust emissions from the kiln firing process	378
4.4.4	Gaseous compounds	379
4.4.4.1	General primary techniques for reducing emissions of gaseous compounds	379
4.4.4.2	NO <sub>x</sub> emissions	379
4.4.4.3	CO emissions and CO trips	380
4.4.4.3.1	CO emissions	380
4.4.4.3.2	Reduction of CO trips	380
4.4.4.4	SO <sub>x</sub> emissions	381
4.4.5	Process losses/waste	382
4.4.6	Use of wastes as fuels and/or raw materials	382
	DESCRIPTION OF TECHNIQUES	383
4.5	Description of techniques for the cement industry	383
4.5.1	Dust emissions	383
4.5.2	NO <sub>x</sub> emissions	384
4.5.3	SO <sub>x</sub> emissions	386
4.6	Description of techniques for lime industry	387
4.6.1	Dust emissions	387
4.6.2	NO <sub>x</sub> emissions	388
4.6.3	SO <sub>x</sub> emissions	388
4.7	Description of techniques for the magnesia industry (dry process route)	389
4.7.1	Dust emissions	389
4.7.2	SO <sub>x</sub> emissions	390
<b>5</b>	<b>CONCLUDING REMARKS AND RECOMMENDATIONS FOR FUTURE WORK</b>	<b>391</b>
5.1	Cement sector	391
5.2	Lime sector	394

5.3	Magnesium oxide sector .....	396
5.4	Consultation of the Forum and subsequent formal adoption procedure of the BAT Conclusions .....	399
<b>6</b>	<b>ANNEXES.....</b>	<b>401</b>
6.1	EC environmental legislation applicable to the production of cement and lime in the EU-27 ..	401
6.2	Annex cement manufacturing .....	402
6.2.1	CEMBUREAU's waste fuel groupings versus those of the EWC.....	402
6.2.2	Cement manufacturing – plant specific data.....	407
6.2.2.1	Examples of types of wastes used, the influence on emissions behaviour and concentration ranges for substances in waste materials (input criteria).....	407
6.2.2.1.1	Examples of concentration ranges for substances in waste materials/waste input criteria .....	412
6.2.2.2	Examples of energy consumption .....	419
6.2.2.3	Examples of emissions data.....	420
6.2.3	Cement manufacturing – cogeneration/recovery of excess heat.....	423
6.2.3.1	Cogeneration of electric power via the conventional steam cycle process – Slite cement plant in Sweden .....	423
6.2.3.2	Cogeneration with the Organic Rankine Cycle (ORC) process – cement plant in Lengfurt in Germany .....	424
6.2.4	Cement manufacturing – examples of NO <sub>x</sub> reduction by using a high efficiency SNCR technique .....	425
6.2.4.1	Example SNCR technique used in Sweden .....	426
6.2.4.2	Example SNCR technique used in Germany .....	430
6.2.5	Cement manufacturing – example of NO <sub>x</sub> reduction by using the SCR technique .....	431
6.2.6	Cement manufacturing – guideline regarding the control of CO trips.....	436
6.2.6.1	Objectives for reducing operational interruptions – CO trips .....	436
6.2.6.2	Strategy of CO minimisation development.....	437
6.2.6.3	CO monitoring system.....	437
6.2.6.4	Actions to be taken in the event of a CO trip.....	438
6.2.6.5	CO and CH <sub>4</sub> in fabric filters .....	438
6.3	Annex lime manufacturing.....	439
6.3.1	Lime manufacturing – distribution of metal concentrations in the flue-gas of lime kilns in the EU-27 .....	439
6.3.2	Lime manufacturing – plant specific data.....	447
6.3.2.1	Examples of raw material characteristics .....	447
6.3.2.2	Use of waste as fuels – examples of acceptable pollutant contents.....	447
6.3.2.3	Examples of consumptions and emissions data .....	449
6.3.3	Lime manufacturing – example for handling waste oil in a shaft kiln (OK) .....	456
6.3.4	Lime manufacturing – example for quality control of solid waste fuels burned in rotary kilns .....	458
6.3.5	Lime manufacturing – example of DeNO <sub>x</sub> treatment by using the SNCR technique in preheater rotary kilns (PRK).....	461
	<b>GLOSSARY .....</b>	<b>465</b>
	<b>REFERENCES .....</b>	<b>473</b>

## List of figures

Figure 1.1:	Cement production in the EU-27 and in the world from 1950 to 2006.....	1
Figure 1.2:	Estimated employment for the cement industry in the EU from 1975 to 2005.....	2
Figure 1.3:	Cement production inclusive of exported clinker and cement consumption in the EU-25....	3
Figure 1.4:	General overview of a cement manufacturing process .....	10
Figure 1.5:	Example of covered raw material storage.....	13
Figure 1.6:	Ternary CaO, SiO <sub>2</sub> and Al <sub>2</sub> O <sub>3</sub> +Fe <sub>2</sub> O <sub>3</sub> diagram for cement clinker and the ash constituents of different raw materials and fuels .....	21
Figure 1.7:	Hazardous waste – impregnated sawdust .....	24
Figure 1.8:	Specially prepared waste fuel based on, e.g. paper, plastics, textiles .....	24
Figure 1.9:	Specially prepared household waste used as fuel in cement kilns .....	24
Figure 1.10:	Schematic view of a preheater/precalciner/grate cooler kiln .....	27
Figure 1.11:	Example of a multi-channel burner.....	28
Figure 1.12:	Grate preheater .....	29
Figure 1.13:	Suspension preheater .....	30
Figure 1.14:	Suspension preheater with precalciner.....	30
Figure 1.15:	Gas and solids temperature profiles in a cyclone preheater kiln system.....	32
Figure 1.16:	Example of a separate line/calciner downdraft.....	33
Figure 1.17:	Example of waste feed points into a calciner.....	33
Figure 1.18:	Example of a planetary cooler .....	36
Figure 1.19:	Mass balance for the production of 1 kg cement using the dry process.....	44
Figure 1.20:	Wastes used as raw materials in 20 countries of the EU-27 .....	46
Figure 1.21:	Fuel energy use in the EU-25 cement industry in 2004.....	47
Figure 1.22:	Consumption of different types of hazardous and non-hazardous waste used as fuel in cement kilns in the EU-27 .....	52
Figure 1.23:	Ranges of emission values from continuous dust measurements in the clean gas from 253 rotary kilns in the EU-27 and EU 23+ countries.....	57
Figure 1.24:	Dust emission values from 180 spot dust measurements in the clean gas of rotary kilns in the EU-27 and EU 23+ countries.....	57
Figure 1.25:	NO <sub>x</sub> emissions (expressed as NO <sub>2</sub> ) from cement kilns in the EU-27 and EU-23+ countries in 2004 categorised by substitution rate.....	62
Figure 1.26:	Distribution of measurements categorised by the thermal substitution rate of NO <sub>x</sub> levels..	62
Figure 1.27:	Achieved NO <sub>x</sub> emissions ranges by using flame cooling in several cement plants in the EU-23+ .....	64
Figure 1.28:	Achieved NO <sub>x</sub> emissions ranges from several cement plant in the EU-23+ not using flame cooling .....	64
Figure 1.29:	NO <sub>x</sub> emissions achieved by several cement plants using SNCR for NO <sub>x</sub> reduction.....	65
Figure 1.30:	NO <sub>x</sub> emissions ranges achieved by several cement plants without using SNCR.....	65
Figure 1.31:	Sulphur flow diagram in a cement preheater/precalciner kiln .....	66
Figure 1.32:	Values of SO <sub>2</sub> measurements in the clean gas from cement plants in the EU-27 and EU-23+ countries.....	68
Figure 1.33:	Distribution of measurements categorised by the thermal substitution rate of SO <sub>2</sub> levels..	69
Figure 1.34:	CO emissions concentration values measured in the clean gas from 29 German rotary kilns in 2004 .....	71
Figure 1.35:	TOC emission values from continuous measurements in the clean gas of cement kilns in the EU-27 and EU-23+ countries .....	72
Figure 1.36:	Distribution of continuous measurements categorised by the thermal substitution rate of TOC levels .....	72
Figure 1.37:	Total organic carbon emissions concentration values measured in the clean gas from 27 German rotary kilns in 2004 .....	73
Figure 1.38:	Emissions of PCDD/F in the EU-27 and EU-23+ countries in 2004 categorised by thermal substitution rate.....	75
Figure 1.39:	Distribution of spot measurements categorised by the thermal substitution rate of PCDD/F levels from cement kilns in the EU-27 and EU-23+ countries .....	75
Figure 1.40:	Emissions of PCDD/F measured in the clean gas of 39 German rotary kilns in 2004.....	76
Figure 1.41:	Pathway of metals in cement kilns with preheaters in a dry process .....	77
Figure 1.42:	Cadmium and thallium emission values from 262 spot $\Sigma$ (Cd, Tl) measurements in the EU-27 and EU-23+ countries .....	79
Figure 1.43:	Distribution of measurements categorised by the thermal substitution rate of $\Sigma$ (Cd, Tl) levels.....	79

Figure 1.44: Emission values from spot $\Sigma$ (Sb, As, Pb, Cr, Co, Cu, Mn, Ni, V) measurements in the EU-27 and EU-23+ countries.....	80
Figure 1.45: Distribution of measurements categorised by the thermal substitution rate of $\Sigma$ (Sb, As, Pb, Cr, Co, Cu, Mn, Ni, V) levels.....	80
Figure 1.46: Mercury emission values from 306 spot Hg measurements in the EU-27 and EU-23+ countries .....	82
Figure 1.47: Mercury emission values from 306 spot Hg measurements in the EU-27 and EU-23+ countries .....	83
Figure 1.48: HCl emission values from continuous HCl measurement in the clean gas from 98 cement kilns in the EU-27 and EU-23+ countries .....	84
Figure 1.49: Distribution of continuous HCl measurements categorised by the thermal substitution rate .....	84
Figure 1.50: Emission values from 233 spot measurements in the clean gas of rotary kilns in the EU-27 and EU-23+ countries .....	85
Figure 1.51: Distribution of HCl spot measurements categorised by the thermal substitution rate of HCl levels .....	85
Figure 1.52: Emissions of gaseous inorganic chlorine compounds, stated as HCl, measured in the clean gas from 38 German rotary kilns in 2004.....	86
Figure 1.53: Emission values from continuous HF emissions measurement in the clean gas from rotary kilns in the EU-27 and EU-23+countries .....	87
Figure 1.54: Distribution of continuous HF emissions measurements categorised by the thermal substitution rate of HF levels .....	87
Figure 1.55: Emission values from spot HF measurements in the clean gas of rotary kilns in the EU-27 and EU-23+ countries .....	88
Figure 1.56: Distribution of HF spot measurements categorised by the thermal substitution rate of HF levels .....	88
Figure 1.57: Emissions of gaseous inorganic fluorine compounds, stated as HF, measured in the clean gas from 38 German rotary kilns in 2004.....	89
Figure 1.58: Ammonia emissions from a Swedish cement plant equipped with a SO <sub>x</sub> scrubber .....	90
Figure 1.59: Benzene emissions concentrations measured from 17 German rotary kilns .....	91
Figure 1.60: Example of a fabric filter and filter material used in a cement plant in the UK.....	120
Figure 1.61: Hybrid filter for dust collection.....	124
Figure 1.62: Injection methods used for flame cooling in cement manufacture in EU-23+ countries ...	128
Figure 1.63: Installation characteristics for flame cooling application in EU-23+ countries .....	129
Figure 1.64: Cement plant characteristics with SNCR application in EU-23+ countries .....	135
Figure 1.65: Nitrogen carriers/NH <sub>2</sub> -X agents used by SNCR in EU-23+ countries .....	136
Figure 1.66: Example of an SCR installation .....	141
Figure 1.67: Example of an individual catalyst used for the SCR technique.....	141
Figure 1.68: Example of a module position used for the SCR technique .....	141
Figure 1.69: Basic operational features of a wet scrubber.....	147
<b>Figure 1.70: Continuous improvement in an EMS model .....</b>	<b>165</b>
Figure 1.71: Fluidised bed cement kiln .....	168
Figure 2.1: Lime and dolomite production in the EU-27 in 2004.....	175
Figure 2.2: Production of commercial lime per type of kiln in the EU-27 in 2004 .....	178
Figure 2.3: Production of commercial dolime per type of kiln in the EU-27 in 2004 .....	179
Figure 2.4: Production of commercial sintered dolime per type of kiln in the EU-27 in 2004.....	179
Figure 2.5: Overview of the lime manufacturing process.....	182
Figure 2.6: Flow diagram of the cornerstones for lime manufacturing .....	183
Figure 2.7: Overview of a lime manufacturing process.....	184
Figure 2.8: Material flow diagram for limestone washing and washing water purification .....	187
Figure 2.9: Types of fuels used for the lime kiln firing process in 2005 in the EU-27.....	188
Figure 2.10: Flow diagram of a shaft kiln dosing system example .....	189
Figure 2.11: Example of a shaft kiln dosing system.....	190
Figure 2.12: Amount of lime produced by using waste fuels in different European countries.....	191
Figure 2.13: Distribution of lime kilns using waste fuels in different European countries.....	192
Figure 2.14: Front view of a multi-channel burner used in a rotary kiln (RK).....	193
Figure 2.15: RK burner engineering .....	193
Figure 2.16: Change of reactivity versus burning temperature and type of limestone.....	196
Figure 2.17: Morphology of soft, medium and hard burned lime.....	197
Figure 2.18: General principles of lime calcination.....	198
Figure 2.19: Flow diagram of a lime hydrator.....	200
Figure 2.20: Principle of a mixed feed shaft kiln.....	204
Figure 2.21: Mixed feed shaft kiln.....	204



Figure 2.22:	Principles of a PFRK .....	206
Figure 2.23:	Example of a PFRK .....	206
Figure 2.24:	Basic operating principle and gas flow in a PFRK .....	206
Figure 2.25:	Annular shaft kiln .....	209
Figure 2.26:	Example of an annular shaft kiln used in lime manufacture1 .....	209
Figure 2.27:	Operating principle of annular shaft kilns (ASK) .....	210
Figure 2.28:	Double inclined shaft kiln.....	211
Figure 2.29:	Gas suspension calcination process diagram .....	213
Figure 2.30:	Operating principle of long rotary kilns.....	214
Figure 2.31:	Example of a long rotary kiln used in lime manufacture .....	216
Figure 2.32:	Rotary kiln with a preheater or a preheater rotary kiln (PRK).....	217
Figure 2.33:	Operating principle of a rotary kiln with a preheater (PRK) .....	218
Figure 2.34:	Example of a rotary kiln with a preheater.....	218
Figure 2.35:	Dust emissions measured from different types of lime kilns using different types of dust abatement techniques in the EU-27 (spot measurements as half hourly values) .....	229
Figure 2.36:	NO <sub>x</sub> emissions measured from different types of lime kilns in the EU-27 (spot measurements as half hourly values) .....	231
Figure 2.37:	SO <sub>2</sub> emissions measured from different types of lime kilns using fossil fuels in the EU-27 (spot measurements as half hourly values) .....	233
Figure 2.38:	SO <sub>2</sub> emissions measured from different types of lime kilns using fossil fuels and waste fuels for kin firing in the EU-27 (spot measurements as half hourly values) .....	234
Figure 2.39:	CO emissions occurring from different types of lime kilns in the EU-27 .....	237
Figure 2.40:	Chemical reactions and energy use in a mixed feed shaft kiln (Boudouard reaction) .....	239
Figure 2.41:	TOC emissions occurring from different types of lime kilns in the EU-27 .....	240
Figure 2.42:	HCl emissions from different lime kilns in the EU-27 .....	243
Figure 2.43:	Schematic view of a conventional electrostatic precipitator (ESP) .....	263
Figure 2.44:	Schematic of a fabric filter with pulse jet cleaning.....	265
Figure 2.45:	Schematic view of an exhaust gas multistage wet scrubber example .....	268
Figure 2.46:	Investment costs as a function of kiln capacity for ESPs and fabric filters – EU-27.....	271
Figure 2.47:	Simulation dedusting cost as a function of dust emission limits for a rotary kiln (RK) with an ESP – EU-27 .....	271
Figure 2.48:	Simulation of maintenance costs for dedusting as a function of dust emission limits for a PFRK and fabric filters – EU-27 .....	272
Figure 2.49:	Simulation of maintenance costs for dedusting as a function of dust emissions ranges for PFRK and fabric filters in Italy in 2007.....	272
Figure 2.50:	NO <sub>x</sub> abatement depending on the temperature .....	279
Figure 2.51:	Flow diagram for the PCDD/F emissions in vertical lime kilns .....	286
Figure 2.52:	Flow diagram for the PCDD/F emissions in rotary kilns (LRK, RPK) .....	287
Figure 2.53:	Fluidised bed kiln .....	293
Figure 2.54:	Example flow diagram of a post-combustion technique.....	294
Figure 3.1:	Global sources of magnesium oxide and producer countries.....	298
Figure 3.2:	Raw magnesite production in the EU-25 and worldwide .....	298
Figure 3.3:	Worldwide production of magnesium oxide modifications in 2003.....	300
Figure 3.4:	Sector specific consumption of magnesia worldwide in 2003.....	303
Figure 3.5:	Worldwide magnesia demand for the production of refractories used in the steel industry .....	304
Figure 3.6:	Process scheme of the natural pathway for magnesia production.....	307
Figure 3.7:	Example process diagram of magnesia production using the dry process route from a DBM plant .....	309
Figure 3.8:	Pathway of coarse and fine magnesite for magnesia production .....	310
Figure 3.9:	Operating principle of rotary kilns with a preheater in magnesia production.....	311
Figure 3.10:	Operating principle of long rotary kilns in magnesia production .....	312
Figure 3.11:	Operating principle of shaft kilns in magnesia production .....	313
Figure 3.12:	Operating principle of double shaft kilns used in magnesia production.....	314
Figure 3.13:	Fuel comparison with regard to specific costs and sulphur content.....	327
Figure 6.1:	Flow diagram of a two step water-based heat recovery system for power cogeneration at the Slite cement plant in Sweden.....	423
Figure 6.2:	Flow diagram of a pentane based waste heat recovery system for power cogeneration at the Lengfurt plant in Germany .....	425
Figure 6.3:	Flow diagram of the cement manufacturing process in Slite (Sweden).....	426
Figure 6.4:	Flow diagram for the injection of NH <sub>3</sub> solution for SNCR at the Slite cement plant in Sweden .....	427

Figure 6.5:	Flow diagram and nozzle plan for the injection of NH <sub>3</sub> solution for SNCR at the Skövde cement plant in Sweden.....	427
Figure 6.6:	NO <sub>x</sub> emissions and the consumption of ammonia water at the cement plants in Slite and Skövde in Sweden from 1995 until 2005 .....	427
Figure 6.7:	NH <sub>3</sub> emissions and ammonia water consumption at two cement kilns at the Slite cement plant in Sweden from 1994 until 2005 .....	429
Figure 6.8:	High efficiency SNCR and place for injection of ammonia water via lances at places Nr. 21 to 26.....	430
Figure 6.9:	Flow diagram of the SCR example plant in Germany (Solnhofer Portland-Zementwerke) .....	432
Figure 6.10:	Distribution of arsenic concentrations in the flue-gas of lime kilns in the EU-27 .....	439
Figure 6.11:	Distribution of cadmium concentrations in the flue-gas of lime kilns in the EU-27 .....	440
Figure 6.12:	Distribution of cobalt concentrations in the flue-gas of lime kilns in the EU-27 .....	440
Figure 6.13:	Distribution of chromium concentrations in the flue-gas of lime kilns in the EU-27 .....	441
Figure 6.14:	Distribution of copper concentrations in the flue-gas of lime kilns in the EU-27 .....	441
Figure 6.15:	Distribution of mercury concentrations in the flue-gas of lime kilns in the EU-27.....	442
Figure 6.16:	Distribution of manganese concentrations in the flue-gas of lime kilns in the EU-27.....	442
Figure 6.17:	Distribution of nickel concentrations in the flue-gas of lime kilns in the EU-27 .....	443
Figure 6.18:	Distribution of lead concentrations in the flue-gas of lime kilns in the EU-27 .....	443
Figure 6.19:	Distribution of antimony concentrations in the flue-gas of lime kilns in the EU-27.....	444
Figure 6.20:	Distribution of selenium concentrations in the flue-gas of lime kilns in the EU-27 .....	444
Figure 6.21:	Distribution of tin concentrations in the flue-gas of lime kilns in the EU-27.....	445
Figure 6.22:	Distribution of tellurium concentrations in the flue-gas of lime kilns in the EU-27 .....	445
Figure 6.23:	Distribution of thallium concentrations in the flue-gas of lime kilns in the EU-27.....	446
Figure 6.24:	Distribution of vanadium concentrations in the flue-gas of lime kilns in the EU-27 .....	446
Figure 6.25:	Distribution of zinc concentrations in the flue-gas of lime kilns in the EU-27 .....	447
Figure 6.26:	Flow diagram of waste oil circulation – going from delivery to the shaft kiln (OK) .....	457
Figure 6.27:	Pumping station number 2 with a filter and a waste container for cleaning the filter .....	457
Figure 6.28:	Measuring and dosing station with pneumatic valves .....	457
Figure 6.29:	Location of injection and connecting points for SNCR in the Flandersbach lime plant in Germany .....	462

## List of tables

Table 1.1:	World cement production by geographic regions in 2006.....	2
Table 1.2:	Number of cement plants in the EU-27 .....	4
Table 1.3:	Domestic deliveries by type of cement in the EU-25 .....	4
Table 1.4:	European standard in the EU-27 for types of cement and their composition.....	6
Table 1.5:	Chemical composition of grey cement .....	7
Table 1.6:	Examples of chemical compositions of white cement clinker .....	7
Table 1.7:	Fuel consumption expressed as a percentage of heat generation by the cement industry in the EU-27.....	8
Table 1.8:	Chemical analyses of raw materials and cement raw meal for the production of cement clinker .....	11
Table 1.9:	Metals in raw materials and raw meal .....	12
Table 1.10:	Examples of chemical compositions of raw materials for white cement clinker production.....	12
Table 1.11:	Chemical analyses of metals in coal .....	15
Table 1.12:	Types of waste frequently used as raw materials in the European cement industry .....	20
Table 1.13:	Example list of wastes used as raw materials classified to their chemical composition and used in cement kilns in the EU-25 .....	20
Table 1.14:	Different types of wastes used as fuels in EU-27 cement kilns in 2003 and 2004.....	22
Table 1.15:	Consumption of raw materials in cement production .....	45
Table 1.16:	Wastes used as raw materials characterised by chemical elements used in cement manufacturing in the EU-27 in 2003 and 2004.....	45
Table 1.17:	Examples of thermal energy required for drying the raw meal.....	46
Table 1.18:	Fuel energy use in cement manufacturing in the EU-27.....	47
Table 1.19:	Comparison of grinding techniques based on key characteristics.....	49
Table 1.20:	Examples of calorific values for different types of wastes used as fuels in the EU-27 .....	50
Table 1.21:	Consumption of different types of waste used as fuels in EU-27 cement kilns in 2003 and 2004 .....	51
Table 1.22:	Substitution of waste fuels for cement production in EU-23+ countries .....	53
Table 1.23:	Data of emissions ranges from European cement kilns .....	55
Table 1.24:	Example of system types used for dust extraction, operational data and energy demand ...	58
Table 1.25:	Examples of frequencies of CO trips in a German cement plant.....	58
Table 1.26:	Investigation on fine dust distribution in total dust from German cement kilns .....	59
Table 1.27:	Examples of raw gas concentration of dust according to the RAINS model .....	59
Table 1.28:	Examples of dust reduction techniques along with reduction efficiencies according to the RAINS model .....	60
Table 1.29:	Ranges of heavy metal concentrations in the clean gas of cement kiln systems' measurements from 1996 to 1998.....	81
<b>Table 1.30:</b>	<b>Information for each technique.....</b>	<b>98</b>
Table 1.31:	Overview of techniques for controlling dust in the cement production process .....	117
Table 1.32:	Key characteristics of different filter media and costs schedules .....	121
Table 1.33:	Techniques for reducing NO <sub>x</sub> emissions used in the cement industries in the EU-27 and EU-23+ countries.....	126
Table 1.34:	Techniques for reducing NO <sub>x</sub> emissions occurring in cement manufacturing processes... ..	127
Table 1.35:	SCR parameters, emissions and costs reported.....	142
Table 1.36:	Overview of techniques for controlling and reducing SO <sub>2</sub> .....	144
Table 1.37:	Abatement techniques for SO <sub>2</sub> reduction used in the EU-27 and EU-23+ countries in 2008 .....	144
Table 1.38:	Example of primary techniques to prevent CO trips from ESPs.....	151
Table 1.39:	Examples of cost data for dust abatement techniques.....	158
Table 1.40:	Examples of costs for NO <sub>x</sub> abatement techniques .....	160
Table 1.41:	Example of costs for SO <sub>x</sub> abatement techniques .....	162
Table 2.1:	Lime, a versatile material – some industrial applications .....	173
Table 2.2:	Best estimate of world quicklime and dolomite production in 2006 in the EU-27, including captive lime production .....	174
Table 2.3:	Distribution of commercial lime by sectors in the EU-27 in 2004 .....	175
Table 2.4:	Trend of raw material limestone and dolomite use in the period 2003 – 2030.....	176
Table 2.5:	Lime nomenclatures, EC and CAS numbers .....	177
Table 2.6:	Number of non-captive lime plants in the EU-27 Member States with production exceeding 50 t/d - total from 2003.....	177
Table 2.7:	Number of operational lime kilns per type of kiln in 2004 in the EU-27 .....	178

Table 2.8:	Number of lime kilns per country in the EU-27 in 2003 for the production of lime and dolime, not including captive kilns .....	180
Table 2.9:	Distribution of fuels used in lime burning in the EU-27 in 2003 .....	180
Table 2.10:	Typical impurities and trace elements in limestone .....	185
Table 2.11:	Types of fuels used in different lime kilns in 2003 in the EU-27.....	188
Table 2.12:	Types of waste fuels used in different European countries .....	193
Table 2.13:	Components of liquid and solid waste fuels.....	193
Table 2.14:	Waste fuels used in different kiln types .....	194
Table 2.15:	Operational parameters for types of lime kilns .....	202
Table 2.16:	Relationship between kilns and types of lime generally produced in these kilns.....	202
Table 2.17:	Indicative lime specifications by consumer groups.....	203
Table 2.18:	Main technical characteristics of mixed feed shaft kilns.....	205
Table 2.19:	Technical characteristics of parallel flow regenerative kilns .....	208
Table 2.20:	Technical characteristics of annular shaft kilns.....	210
Table 2.21:	Technical characteristics of long rotary kilns (LRK) .....	215
Table 2.22:	Technical characteristics of preheater rotary kilns (PRK).....	219
Table 2.23:	Typical heat and electrical use by kiln types in the EU-27 for lime and dolime manufacture .....	225
Table 2.24:	Examples of typical emissions occurring from lime kilns in Europe .....	228
Table 2.25:	CO <sub>2</sub> emissions factors from different kiln types in the lime industry .....	236
Table 2.26:	Average PCDD/F emissions for different types of kilns in the EU-27 .....	241
Table 2.27:	Typical HCl and HF emissions from various types of lime kilns in the EU-27 .....	242
Table 2.28:	Number of plants achieving different metal emissions in the EU-27.....	245
Table 2.29:	Typical analysis results from the quality of waste oil used in German shaft kilns.....	246
Table 2.30:	Individual emissions measurements from a German shaft kiln using waste oil .....	246
Table 2.31:	Continuous emissions measurements taken in 2006 from a German rotary kiln using solid fuels.....	248
Table 2.32:	Periodical individual emissions measurements taken in 2006 from a German rotary kiln using solid fuels.....	248
<b>Table 2.33:</b>	<b>Information for each technique .....</b>	<b>253</b>
Table 2.34:	Options for energy efficiency improvement in lime kilns.....	255
Table 2.35:	Overview of techniques for controlling dust in the lime production process .....	262
Table 2.36:	Investments and costs of dust abatement techniques.....	273
Table 2.37:	Proportions of different kinds of costs included in operating costs for abatement techniques .....	274
Table 2.38:	Overview of NO <sub>x</sub> reduction techniques in the lime industry.....	275
Table 2.39:	Theoretical operational data for the SNCR process .....	279
Table 2.40:	Theoretical temperature ranges and reduction rates necessary for the SCR process.....	281
Table 2.41:	Flue-gas composition monitored over several hours.....	295
Table 3.1:	Worldwide production of raw magnesite (magnesium carbonate) from 2000 to 2005 .....	299
Table 3.2:	Worldwide production of sintered magnesium oxide/magnesia in 2003 .....	300
Table 3.3:	Producers of sintered magnesia in the EU-27 .....	301
Table 3.4:	Production of magnesite and magnesia by using the dry process route in the EU-25 in 2003 .....	301
Table 3.5:	Amounts of magnesia and carbon dioxide after decomposition.....	316
Table 3.6:	Yield of magnesia and carbon oxide in magnesite.....	317
Table 3.7:	Fuel requirements for the production of one tonne magnesia (MgO) .....	317
Table 3.8:	Examples of the relationship between grain size and sulphur content in the raw materials .....	318
Table 3.9:	Concentrations of emissions components occurring from the magnesium oxide industry in the EU-27 .....	319
<b>Table 3.10:</b>	<b>Information for each technique .....</b>	<b>323</b>
<b>Table 4.1:</b>	<b>BAT-associated energy consumption levels for new plants and major upgrades using dry process kiln with multistage preheating and precalcination .....</b>	<b>348</b>
<b>Table 4.2:</b>	<b>BAT-associated emission levels for NO<sub>x</sub> from the flue-gases of kiln firing and/or preheating/precalcining processes in the cement industry.....</b>	<b>355</b>
<b>Table 4.3:</b>	<b>BAT-associated emission levels for NH<sub>3</sub> slip from the flue-gases .....</b>	<b>356</b>
<b>Table 4.4:</b>	<b>BAT-associated emission levels for SO<sub>x</sub> from the flue-gases of kiln firing and/or preheating/precalcining processes in the cement industry.....</b>	<b>357</b>
<b>Table 4.5:</b>	<b>BAT-associated emission levels for metals from the flue-gases of kiln firing processes.....</b>	<b>360</b>
<b>Table 4.6:</b>	<b>BAT-associated levels for thermal energy consumption in the lime and dolime industry.....</b>	<b>364</b>
<b>Table 4.7:</b>	<b>BAT-associated emission levels for channelled dust emissions from dusty operations other than those from kiln firing processes.....</b>	<b>367</b>

Table 4.8:	BAT-associated emission levels for dust emissions from the flue-gases of kiln firing processes.....	368
Table 4.9:	BAT-associated emission levels for NO <sub>x</sub> from flue-gases of kiln firing processes in the lime industry.....	369
Table 4.10:	BAT-associated emission levels for SO <sub>x</sub> from flue-gases of kiln firing processes in the lime industry.....	371
Table 4.11:	BAT-associated emission levels for CO from the flue-gas of kiln firing processes.....	371
Table 4.12:	BAT-associated emission levels for TOC from the flue-gas of kiln firing processes.....	372
Table 4.13:	BAT-associated emission levels for HCl and HF emissions from the flue-gas of kiln firing processes, when using wastes.....	373
Table 4.14:	BAT associated emission levels for metals from the flue-gases of kiln firing processes, when using wastes.....	374
Table 4.15:	BAT-associated emission levels for SO <sub>x</sub> from flue-gases of kiln firing processes in the magnesia industry.....	381
Table 6.1:	CEMBUREAU's waste fuel groupings versus those of the EWC.....	406
Table 6.2:	Types and quantities of waste and waste fuels used in German cement kilns in 2004.....	407
Table 6.3:	Quantities of different types of waste fuels used in the German cement industry.....	407
Table 6.4:	Examples of accepted values of different parameters for the use of industrial waste and solvents.....	408
Table 6.5:	Operational data of a German cement kiln using waste fuels (average of the data for a period of three days).....	409
Table 6.6:	Results from emissions monitoring by using waste fuels in a German cement kiln.....	409
Table 6.7:	Quality data sheet for a waste fuel from Estonia.....	410
Table 6.8:	Analysis of characteristics from an Estonian cement plant.....	411
Table 6.9:	Quality requirements for the waste from an Estonian cement plant.....	412
Table 6.10:	Consumption of waste fuels used in an Estonian cement plant.....	412
Table 6.11:	Limit values in different permits and regulations in Austria, Switzerland and Germany for used wastes.....	413
Table 6.12:	Examples of limit values for waste fuels for different countries/regions based on individual permits.....	414
Table 6.13:	Examples of limit values for wastes to be used as raw materials in different countries/regions.....	415
Table 6.14:	Examples of typical concentration ranges of metals from waste fuels.....	415
Table 6.15:	Examples of input criteria for the use of suitable waste applied in German cement kilns.....	416
Table 6.16:	Examples of permit criteria (maximum values) for substances in wastes used in Austrian cement plants.....	416
Table 6.17:	Examples of permit criteria (median and 80 percentile values) for substances in waste used in Austrian cement plants.....	417
Table 6.18:	Examples of input criteria for substances for suitable waste fuels used in cement plants with French permits.....	418
Table 6.19:	Examples of input criteria for substances for suitable waste fuels used in cement plants in Spain and Poland.....	418
Table 6.20:	Input criteria specifications of a waste example.....	419
Table 6.21:	Fuel consumption in the Austrian cement industry.....	419
Table 6.22:	Examples of different emissions data from an Estonian cement plant in 2006 compared with permitted emissions data.....	420
Table 6.23:	Examples of fine dust emissions PM <sub>10</sub> and PM <sub>2.5</sub> measured from cement plants in Ireland.....	421
Table 6.24:	Amounts of pollutants in waste water in from an Estonian cement plant.....	422
Table 6.25:	Basic assumptions from the SCR plant in Germany.....	434
Table 6.26:	Comparison of costs for the NO <sub>x</sub> abatement techniques of SNCR versus SCR from German UBA for a German plant.....	434
Table 6.27:	Cost calculations for NO <sub>x</sub> abatement by using SCR for a German cement plant with a capacity of 1500 t/d.....	435
Table 6.28:	Example of primary techniques to prevent CO trips from ESPs.....	438
Table 6.29:	Example of raw material composition used in a Hungarian lime plant.....	447
Table 6.30:	Typical pollutant contents accepted for waste oil solvents, animal fat and animal meal (carcase meal) used in German lime plants.....	448
Table 6.31:	Examples of permit criteria (median and maximum values) for substances for different waste fuels used in German lime plants.....	449
Table 6.32:	Operating data and specific energy demand of Austrian lime kilns in 2004.....	449
Table 6.33:	Energy consumption by various types of lime kilns in Spain.....	450
Table 6.34:	Typical examples of emissions from lime kilns in Germany.....	451

---

Table 6.35:	Examples of NO <sub>x</sub> emissions observed in EU Member States .....	452
Table 6.36:	Emissions from Austrian lime kilns .....	453
Table 6.37:	Emissions of dust, NO <sub>x</sub> , SO <sub>x</sub> , CO and CO <sub>2</sub> from several Finnish lime plants using different types of lime kilns from 1998 to 2006.....	455
Table 6.38:	Metal emissions from a Finnish lime plant .....	456
Table 6.39:	List of wastes that can be used in these German lime kilns .....	458
Table 6.40:	Median and maximal concentrations of metals for each type of waste fuel.....	459
Table 6.41:	Minimum and maximum net calorific values for each type of waste fuel.....	459
Table 6.42:	Examples of techniques for the quality assurance of wastes.....	460

WORKING DRAFT IN PROGRESS

## SCOPE

**\*\*NOTE to Article 13 Forum members: Scope text has been deleted and replaced with the new Scope text included in the BAT conclusion\*\***

This BREF for the Production of Cement, Lime and Magnesium Oxide covers the following activities within the scope of Annex I of Directive 2010/75/EU:

- 3.1. Production of cement, lime and magnesium oxide:
  - (a) production of cement clinker in rotary kilns with a production capacity exceeding 500 tonnes per day or in other kilns with a production capacity exceeding 50 tonnes per day;
  - (b) production of lime in kilns with a production capacity exceeding 50 tonnes per day;
  - (c) production of magnesium oxide in kilns with a production capacity exceeding 50 tonnes per day.

Regarding point 3.1(c) above, these BAT conclusions only address the production of MgO using the dry process route based on mined natural magnesite (magnesium carbonate  $MgCO_3$ ).

In particular, this document covers the following processes and activities:

- production of cement, lime and magnesium oxide (dry process route)
- raw materials – storage and preparation
- fuels – storage and preparation
- use of waste as raw materials and/or fuels, quality requirements, control and preparation
- products – storage and preparation
- packaging and dispatch.

The following activities are not within the scope of this BREF:

- the production of magnesium oxide using the wet process route using magnesium chloride as the starting material, covered by the Reference Document on Best Available Techniques for Large Volume Inorganic Chemicals – Solids and Others Industry (LVIC-S)
- the production of ultra low-carbon dolime
- shaft kilns for cement clinker production
- activities which are not directly associated with the primary activity such as quarrying (covered in the Reference Document on Best Available Techniques for the Management of Tailings and Waste-rock in Mining Activities).

Other reference documents which are relevant for the sectors covered in this document are the following:

Reference documents	Activity
Emissions from Storage (EFS)	Storage and handling of raw materials and products
General Principles of Monitoring (MON)	Emissions monitoring
Waste Treatments Industries (WT)	Waste treatment
Energy Efficiency (ENE)	General energy efficiency
Economic and Cross-media Effects (ECM)	Economics and cross-media effects of techniques

The scope of the BREF does **not** include matters that only concern safety in the workplace or the safety of products because these matters are not covered by the Directive. They are discussed only where they affect matters within the scope of the Directive.

---

WORKING DRAFT IN PROGRESS

---



# 1 CEMENT INDUSTRY

## 1.1 General information about the cement industry

Cement is a finely ground, non-metallic, inorganic powder, and when mixed with water forms a paste that sets and hardens. This hydraulic hardening is primarily due to the formation of calcium silicate hydrates as a result of the reaction between mixing water and the constituents of the cement. In the case of aluminous cements, hydraulic hardening involves the formation of calcium aluminate hydrates.

Cement is a basic material for building and civil engineering construction. In Europe the use of cement and concrete (a mixture of cement, aggregates, sand and water) in large civic works can be traced back to antiquity. Portland cement, the most widely used cement in concrete construction, was patented in 1824. Output from the cement industry is directly related to the state of the construction business in general and therefore tracks the overall economic situation closely.

As shown in Figure 1.1, world cement production has grown steadily since 1950, with increased production in developing countries, particularly in Asia, accounting for the lion's share of growth in world cement production in the 1990s.

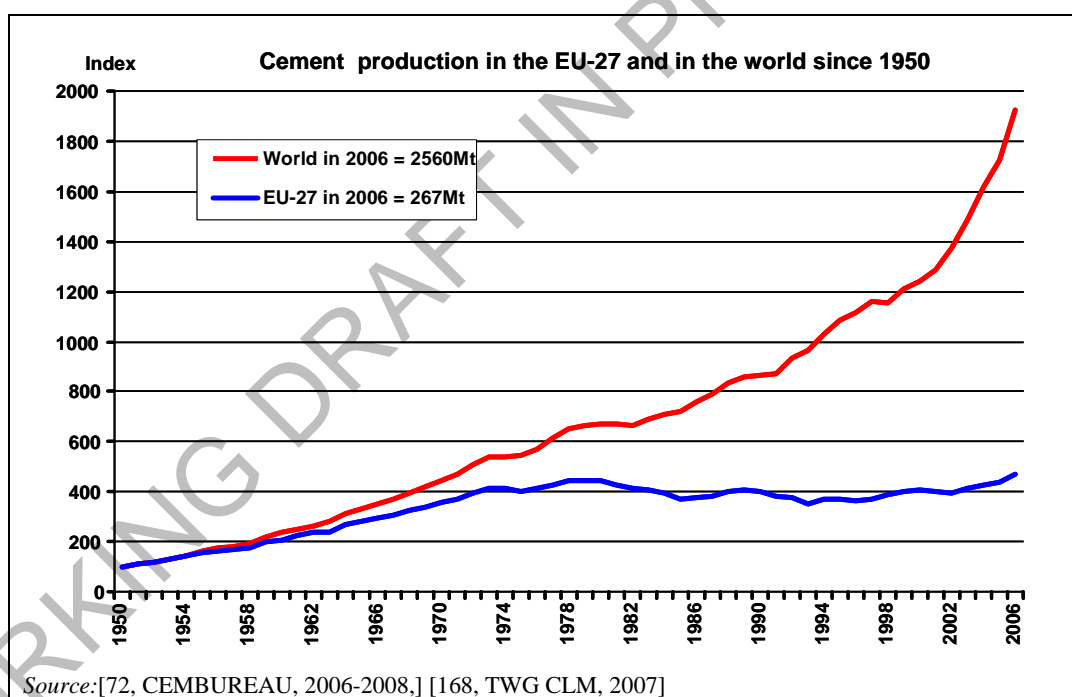


Figure 1.1: Cement production in the EU-27 and in the world from 1950 to 2006

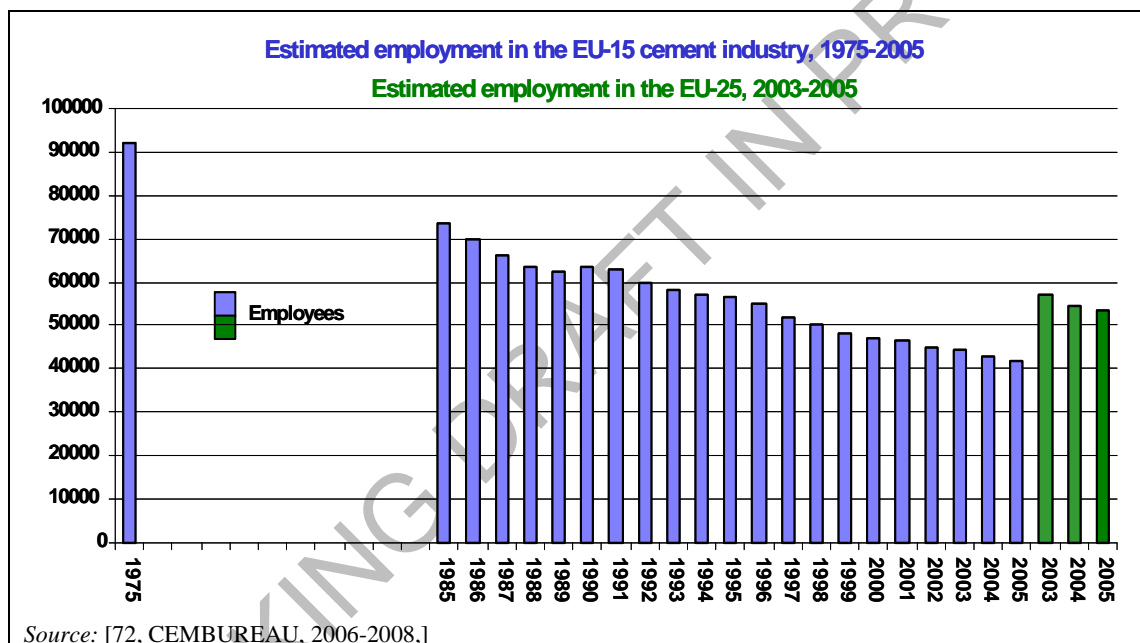
In 2006, world production of cement stood at 2540 million tonnes. Table 1.1 shows the distribution of cement production by geographic regions.

Region	Unit	2006	Region	Unit	2006
China	%	47.4	US	%	3.9
India	%	6.2	Other America	%	5.8
Japan	%	2.7	Africa	%	4.0
Other Asia	%	13.2	CIS	%	3.4
EU-27	%	10.5	Oceania	%	0.4
Other Europe	%	2.5			

*Source: [72, CEMBUREAU, 2006-2008.]*

**Table 1.1: World cement production by geographic regions in 2006**

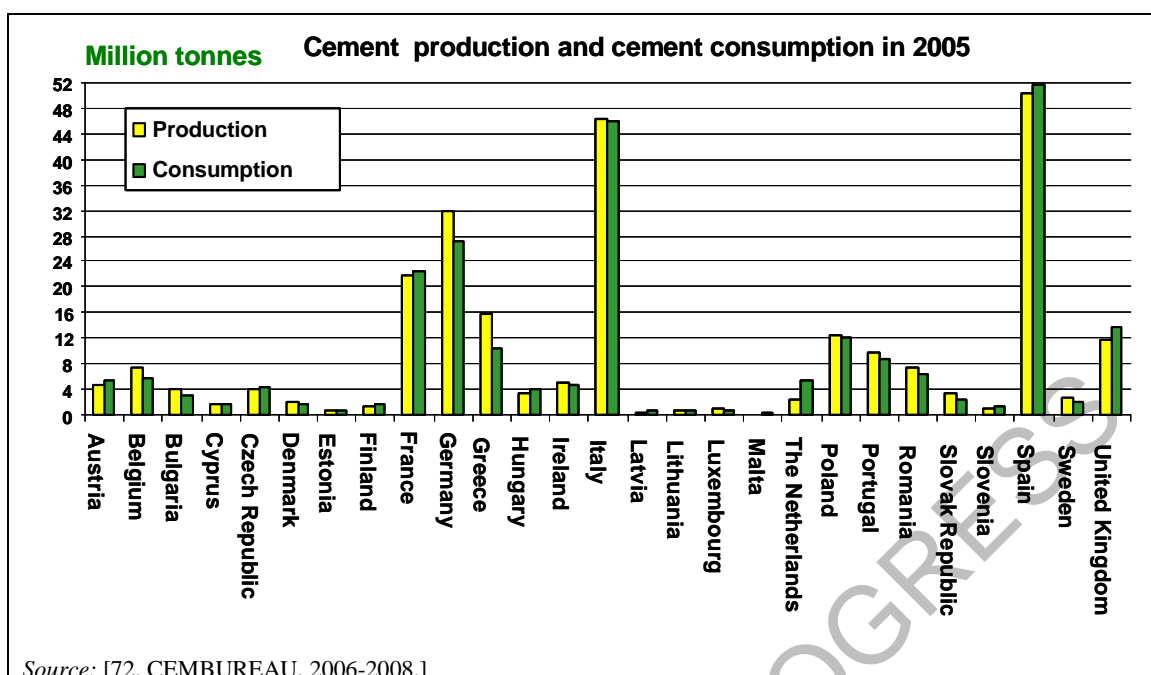
Producers in the European Union have increased cement output per man per year from 1700 tonnes in 1970 to 3500 in 1991. This increase in productivity is a result of the introduction of larger scale production units. These use advanced operation automation and therefore require fewer, but more highly qualified staff. The number of people employed in the cement industry in the European Union (EU-27) was about 54 000 in 2005. Figure 1.2 shows the estimated workforce of the cement industry in the EU from 1975 to 2005 along with employment figures for the EU-25. The figures related to the years before 1991 do not include employees from the former East Germany.



**Figure 1.2: Estimated employment for the cement industry in the EU from 1975 to 2005**

In 2006, cement production in the EU-25 totalled 267.5 million tonnes and consumption 260.6 million tonnes. 38 million tonnes of cement were imported and 32 million tonnes exported. These figures include trade between EU countries.

Production and consumption of cement in the EU-25 in 2005 is shown in Figure 1.3.



**Figure 1.3: Cement production inclusive of exported clinker and cement consumption in the EU-25**

The world's five largest cement producers are Lafarge, Holcim, Cemex, HeidelbergCement and Italcementi. Apart from producing cement, these companies have also diversified into several other building material sectors such as aggregates, concrete products, plasterboard, etc.

Cement is mainly delivered by producers to their customers by road in the EU and there is a limit to the distance over which it can be delivered by road under normal trading conditions due to costs of road transport and the relatively low unit selling price of cement. The maximum distance over which cement is transported by road is generally said to be between 200 and 300 km. However, where cement plants are located near water (sea, inland waterways), transport over longer distances is more common. Furthermore, having easy access to rail networks facilitates transport over longer distances in certain circumstances. Global trade does exist and in some cases it is economically viable to ship cement around the world. The presence of cement terminals (e.g. floating terminals) has contributed to the increase of imports of cement into EU markets from countries outside the EU. International competition is mainly a threat for individual plants, and within the EU increasing imports from Eastern Europe do affect local market conditions. It has been estimated that, in 2007, Greece, Italy, Portugal, Spain, southern France and the UK as a whole were regarded as areas open to imports. These areas represent 60% of the EU's cement production in volume. Denmark, Norway and Sweden are also vulnerable. In 2005, 15.5 million tonnes were imported into the EU from countries with no carbon constraint compared to 13.5 million tonnes in 2004.

There are 268 installations producing cement clinker and finished cement in the EU-27. In addition, there are two clinker plants (kilns) without mills and 90 grinding plants (cement mills) without kilns (cement mills without kilns are not covered by this document), as shown in Table 1.2.

EU Member State		Cement plants – with kilns –	Cement plants – with cement mills only –
Belgium <sup>1</sup>	BE	5	4
Bulgaria	BG	5	-
Czech Republic	CZ	6	1
Denmark	DK	1	-
Germany	DE	38	20
Estonia	EE	1	-
Ireland	IE	4	-
Greece	EL	8	-
Spain	ES	37	13
France	FR	33	6
Italy	IT	59	35
Cyprus	CY	2	-
Latvia	LV	1	-
Lithuania	LT	1	-
Luxembourg <sup>(1)</sup>	LU	1	1
Hungary	HU	4	-
Malta	MT		
Netherlands	NL	1	2
Austria	AT	9	3
Poland	PL	11	1
Portugal	PT	6	2
Romania	RO	8	1
Slovenia	SI	2	
Slovakia	SK	6	-
Finland	FI	2	-
Sweden	SE	3	-
United Kingdom	UK	14	1
Total		268	90
<sup>(1)</sup> Including one clinker plant Source: [72, CEMBUREAU, 2006-2008,]			

**Table 1.2: Number of cement plants in the EU-27**

There are a total of 377 kilns in the EU-27, but in 2007, not all were in operation. In recent years, typical kiln size has come to be around 3000 tonnes clinker per day, and although kilns of widely different sizes and ages exist, very few kilns have a capacity of less than 500 tonnes per day.

In 2007, about 90 % of Europe's cement production is from dry process kilns, a further 7.5 % of production is accounted for by semi-dry and semi-wet process kilns, with the remainder of European production – about 2.5 % – now coming from wet process kilns. The choice of manufacturing process is primarily motivated by the nature of the available raw materials.

The European standard (EN 197-1) for common cement, lists 27 different cement types into five groups. In addition, there is a range of special cements produced for particular applications. The European standard for cement produced in the EU-27 is shown in Table 1.4 while Table 1.3 shows the percentages of each type of cement supplied to domestic markets in 2005 in the EU-25. Furthermore, typical compositions of grey cement are shown in Table 1.5.

Type of cement	Unit	2005
CEM II Portland – composite	%	58.6
CEM I Portland	%	27.4
CEM III Blast furnace/slag	%	6.4
CEM IV Pozzolanic	%	6.0
CEM V Composite cement and other cements	%	1.6

Source: [72, CEMBUREAU, 2006-2008,]

**Table 1.3: Domestic deliveries by type of cement in the EU-25**

Main types	Notation of the 27 products (types of common cement)		Composition (percentage by mass <sup>(1)</sup> )											
			Main constituents									Minor Additional constituents		
			Clinker	Blast Furnace Slag	Silica Fume	Pozzolana		Fly ash		Burnt shale	Limestone			
						Natural	Natural Calcined	Siliceous	Calcareous					
K	S	D <sup>(2)</sup>	P	Q	V	W	T	L <sup>(4)</sup>	LL <sup>(5)</sup>					
CEM I	Portland cement	CEM I	95 – 100	-	-	-	-	-	-	-	-	-	0 – 5	
CEM II	Portland - slag cement	CEM II/A-S	80 – 95	6 – 20	-	-	-	-	-	-	-	-	0 – 5	
		CEM II/B-S	65 – 79	21 – 35	-	-	-	-	-	-	-	-	0 – 5	
	Portland - silica fume cement	CEM II/A-D	90 – 94	-	6 – 10	-	-	-	-	-	-	-	0 – 5	
	Portland – pozzolana cement	CEM II/A-P	80 – 94	-	-	6 – 20	-	-	-	-	-	-	-	0 – 5
		CEM II/B-P	65 – 79	-	-	21 – 35	-	-	-	-	-	-	-	0 – 5
		CEM II/A-Q	80 – 94	-	-	-	6 – 20	-	-	-	-	-	-	0 – 5
		CEM II/B-Q	65 – 79	-	-	-	21 – 35	-	-	-	-	-	-	0 – 5
	Portland - fly ash sement	CEM II/A-V	80 – 94	-	-	-	-	6 – 20	-	-	-	-	-	0 – 5
		CEM II/B-V	65 – 79	-	-	-	-	21 – 35	-	-	-	-	-	0 – 5
		CEM II/A-W	80 – 94	-	-	-	-	-	6 – 20	-	-	-	-	0 – 5
		CEM II/B-W	65 – 79	-	-	-	-	-	21 – 35	-	-	-	-	0 – 5
	Portland - burnt shale	CEM II/A-T	80 – 94	-	-	-	-	-	-	6 – 20	-	-	-	0 – 5
		CEM II/B-T	65 – 79	-	-	-	-	-	-	21 – 35	-	-	-	0 – 5
	Portland – limestone cement	CEM II/A-L	80 – 94	-	-	-	-	-	-	-	6 – 20	-	-	0 – 5
CEM II/B-L		65 – 79	-	-	-	-	-	-	-	21 – 35	-	-	0 – 5	
CEM II/A-LL		80 – 94	-	-	-	-	-	-	-	-	6 – 20	-	0 – 5	

Chapter 1

	Portland - composite cement	CEM II/B-LL	65 – 79	-	-	-	-	-	-	-	-	21 – 35	0 – 5
		CEM II/A-M	80 – 94	6 – 20									0 – 5
		CEM II/B-M	65 – 79	21 – 35									0 – 5
CEM III	Blast furnace cement	CEM III/A	35 – 64	36 – 65	-	-	-	-	-	-	-	-	0 – 5
		CEM III/B	20 – 34	66 – 80	-	-	-	-	-	-	-	-	0 – 5
		CEM III/C	5 – 19	81 – 95	-	-	-	-	-	-	-	-	0 – 5
CEM IV	Pozzolanic cement <sup>(3)</sup>	CEM IV/A	65 – 89	-	11 – 35					-	-	-	0 – 5
		CEM IV/B	45 – 64	-	36 – 55					-	-	-	0 – 5
CEM V	Composite cement <sup>(3)</sup>	CEM V/A	40 – 64	18 – 30	-	18 – 30		-	-	-	-	-	0 – 5
		CEM V/B	20 – 38	31 – 50	-	31 – 50		-	-	-	-	-	0 – 5
<p>(<sup>1</sup>) The values in this table refer to the sum of the major and minor additional constituents.</p> <p>(<sup>2</sup>) The proportion of silica fumes is limited to 10 %.</p> <p>(<sup>3</sup>) In portland - composite cements CEM II/A-M and CEM II/B-M, in pozzolanic cements CEM IV/A and CEM IV/B and in composite cements CEM V/A and CEM V/B the main constituents other than clinker shall be declared by designation of the cement</p> <p>(<sup>4</sup>) Limestone up to 0,50 % TOC</p> <p>(<sup>5</sup>) Limestone up to 0,20 % TOC</p> <p>Source: [149, CEN/EN 197-1, 2000]</p>													

**Table 1.4: European standard in the EU-27 for types of cement and their composition**

	IUPAC nomenclature <sup>(1)</sup>	CAS number	EC number	Mol. formula Hill method	Mol. weight	Typical concentration (% w/w)	Concentration range (% w/w)
<b>Composition information – Main constituents</b>							
A	Tricalcium silicate	12168-85-3	235-336-9	3CaO•SiO <sub>2</sub>	228	65	40 – 80
B	Dicalcium silicate	10034-77-2	233-107-8	2CaO•SiO <sub>2</sub>	172	15	10 – 50
C	Tricalcium aluminate	12042-78-3	234-932-6	3CaO•Al <sub>2</sub> O <sub>3</sub>	270	10	0 – 15
D	Tetracalcium aluminoferrite	12068-35-8	235-094-4	4CaO•Al <sub>2</sub> O <sub>3</sub> •Fe <sub>2</sub> O <sub>3</sub>	486	10	0 – 20
<b>Composition information – Impurities and additives</b>							
E <sup>(2)</sup>	Calcium oxide	1305-78-8	215-138-9	CaO		1	0 – 3
F	Magnesium oxide	1309-48-4	215-171-9	MgO		2	0 – 5
G	Dipotassium sulphate	10233-01-9	233-558-0	K <sub>2</sub> SO <sub>4</sub>		1	0 – 2
H	Disodium sulphate	7757-82-6	231-820-9	Na <sub>2</sub> SO <sub>4</sub>		0.5	0 – 1
Number of non-specified impurities:				<1 w/w %			
Total concentration of non-specified impurities:							
Additives				not available			
<sup>(1)</sup> International Union of Pure and Applied Chemistry nomenclature <sup>(2)</sup> Calcium oxide is found in free form as 'free lime'. CaO is also present bound in the four main phases A-B-C-D Note: Cements containing Portland cement clinker may release, upon reaction with water, traces of soluble chromate. Measures to prevent harmful dermatological effects are described in Commission Directive 2005/53/EC of 16 September 2005 amending Council Directive 91/414/EEC to include chlorothalonil, chlorotoluron, cypermethrin, daminozide and thiophanate-methyl as active substances. Source: [103, CEMBUREAU, 2006]							

**Table 1.5: Chemical composition of grey cement**

Besides grey Portland cement, other specifications of cement are also produced, such as white cement. Except for colour, this type of cement has the same properties as grey cement. For white cement production, only materials which do not have a negative effect on the colour of this special type of cement are used. Table 1.6 shows some examples of parameters corresponding to white cement of the American and European markets. The local demand for whiteness will influence these parameters. Furthermore, the great difference is shown in the Fe<sub>2</sub>O<sub>3</sub> content with respect to the range of grey cement.

Characteristics		White cement
Chemical composition (%)	SiO <sub>2</sub>	22.5 – 23.8
	Al <sub>2</sub> O <sub>3</sub>	2.3 – 6.2
	Fe <sub>2</sub> O <sub>3</sub>	0.19 – 0.4
	CaO	66.3 – 68.0
	MgO	0.48 – 1.0
	SO <sub>3</sub>	0.65 – 2.8
	F	0.24 – 0.85
	K <sub>2</sub> O	0.12 – 0.14
Loss on ignition (%)		0.50 – 1.7
Na <sub>2</sub> O		0.17
Potential compound composition (%)	C <sub>3</sub> S (3 CaO SiO <sub>2</sub> )	69.89
	C <sub>2</sub> S (2 CaO SiO <sub>2</sub> )	19
	C <sub>3</sub> A (3 CaO Al <sub>2</sub> O <sub>3</sub> )	8.08
	C <sub>4</sub> AF (4 CaO Al <sub>2</sub> O <sub>3</sub> Fe <sub>2</sub> O <sub>3</sub> )	1
Blaine fineness (m <sup>2</sup> /kg)		464
Source: [103, CEMBUREAU, 2006], [118, Germany, 2007], [119, Sobolev, 2001]		

**Table 1.6: Examples of chemical compositions of white cement clinker**

The whiteness of this type of cement is one of the most important characteristics. Different specifications are used for the whiteness of this cement according to different national standards [118, Germany, 2007], [119, Sobolev, 2001].

The cement industry is an energy intensive industry with energy typically accounting for about 40 % of operational costs, i.e. excluding capital costs but including electricity costs. Traditionally, the primary solid fossil fuel used was coal. A wide range of other solid, liquid or gaseous fossil fuels are used, such as petroleum coke, lignite, natural gas and oil (heavy, medium or light fuel oil). In addition to these traditional types of fossil fuels, the cement industry has been using large quantities of waste fuels or biomass fuels, for more than 15 years.

Type of fuel	Unit	2006
Petcoke (fossil)	%	38.6
Coal (fossil)	%	18.7
Petcoke and coal (fossil) <sup>(1)</sup>	%	15.9
Fuel oil including HVFO <sup>(2)</sup>	%	3.1
Lignite and other solid fuels (fossil)	%	4.8
Natural gas (fossil)	%	1.0
Waste fuels	%	17.9
Excluded: IE, CY, LT, SL Estimated: IT, PT, SE <sup>(1)</sup> reported by the EU-23+ members <sup>(2)</sup> HVFO = highly viscous fuel oil Source: [72, CEMBUREAU, 2006-2008,], [168, TWG CLM, 2007]		

**Table 1.7: Fuel consumption expressed as a percentage of heat generation by the cement industry in the EU-27**

The emissions from cement plants which cause greatest concern and which need to be dealt with are dust, nitrogen oxides (NO<sub>x</sub>) and sulphur dioxide (SO<sub>2</sub>). Other emissions to be considered are volatile organic compounds (VOCs), polychlorinated dibenzo-p-dioxins (PCDD) and dibenzofurans (PCDF) as well as hydrogen chloride (HCl). Also emissions of carbon oxides (CO, CO<sub>2</sub>), hydrogen fluoride (HF), ammonia (NH<sub>3</sub>), benzene, toluene, ethylbenzene and xylene (BTEX), polyaromatic hydrocarbons (PAH), metals and their compounds, noise and odours may be considered under special circumstances.

Conventional raw materials and fuels are replaced by suitable waste and/or biomass and are used in the cement manufacturing process.

The cement industry is also a capital intensive industry. The cost of a new cement plant is equivalent to around three years' turnover, which ranks the cement industry among the most capital intensive industries. The profitability of the cement industry is around 10 % as a proportion of turnover (on the basis of pre-tax profits before interest repayments).



## 1.2 Applied processes and techniques in cement manufacturing

The basic chemistry of the cement manufacturing process begins with the decomposition of calcium carbonate ( $\text{CaCO}_3$ ) at about  $900\text{ }^\circ\text{C}$  to leave calcium oxide ( $\text{CaO}$ , lime) and liberated gaseous carbon dioxide ( $\text{CO}_2$ ); this process is known as calcination. This is followed by the clinkering process in which the calcium oxide reacts at a high temperature (typically  $1400 - 1500\text{ }^\circ\text{C}$ ) with silica, alumina, and ferrous oxide to form the silicates, aluminates, and ferrites of calcium which comprise the clinker. The clinker is then ground or milled together with gypsum and other additives to produce cement.

There are four main process routes for the manufacture of cement – the dry, semi-dry, semi-wet and wet processes:

- in the dry process, the raw materials are ground and dried to raw meal in the form of a flowable powder. The dry raw meal is fed to the preheater or precalciner kiln or, more rarely, to a long dry kiln
- in the semi-dry process, dry raw meal is pelletised with water and fed into a grate preheater before the kiln or to a long kiln equipped with crosses
- in the semi-wet process, the slurry is first dewatered in filter presses. The filter cake is extruded into pellets and fed either to a grate preheater or directly to a filter cake dryer for raw meal production
- in the wet process, the raw materials (often with a high moisture content) are ground in water to form pumpable slurry. The slurry is either fed directly into the kiln or first to a slurry dryer.

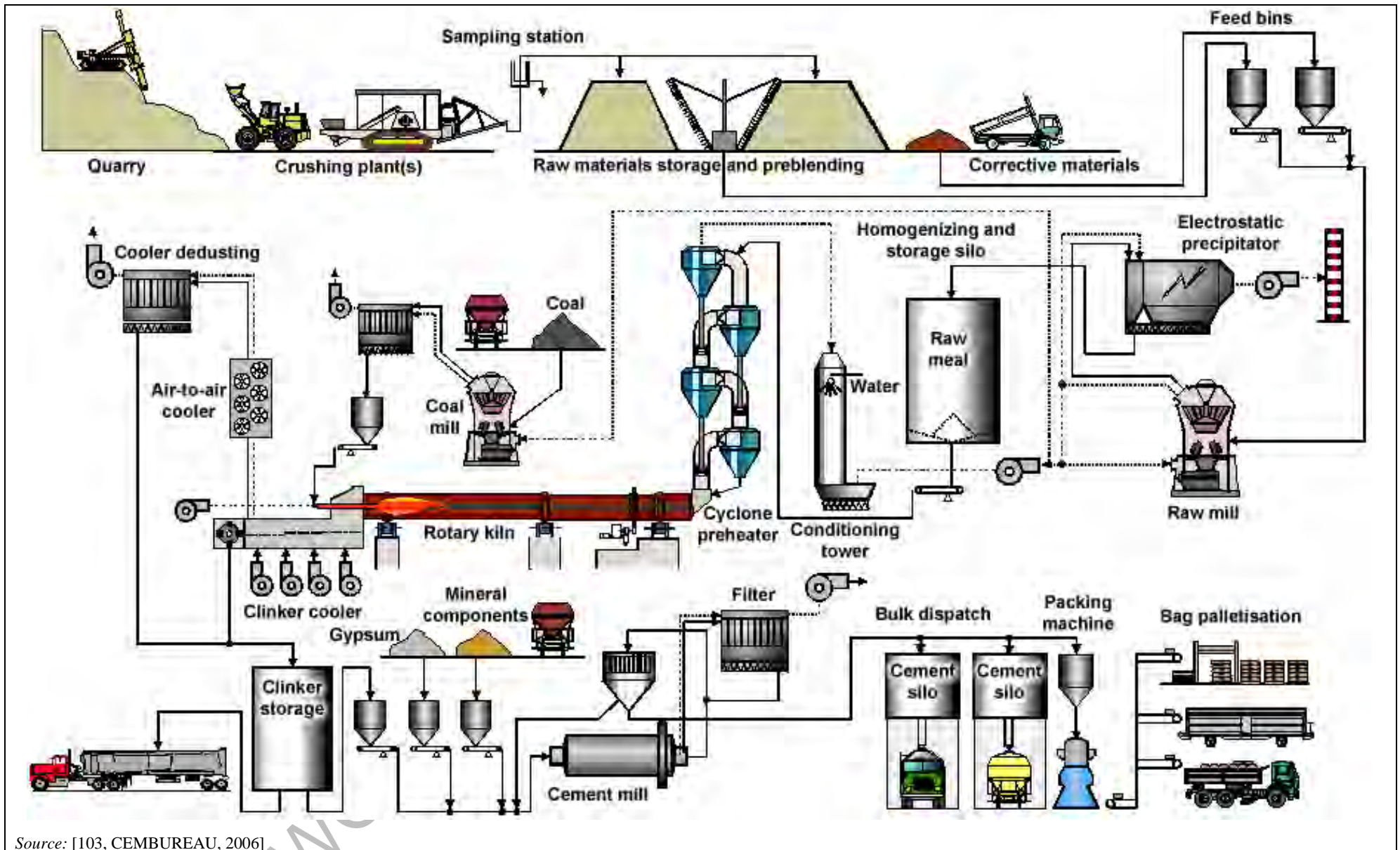
The choice of process is, to a large extent, determined by the state of the raw materials (dry or wet). A large part of world clinker production is still based on wet processes. However, in Europe, more than 90 % of production is based on dry processes thanks to the availability of dry raw materials. Wet processes are more energy consuming, and thus more expensive. Plants using semi-dry processes are likely to change to dry techniques whenever expansion or major improvement is required. Plants using wet or semi-wet processes normally only have access to moist raw materials, as is the situation in Denmark and Belgium, and to some extent in the UK.

All processes have the following sub-processes in common:

- raw materials – storage and preparation
- fuels – storage and preparation
- use of wastes as raw materials and/or fuels, quality requirements, control and preparation
- the kiln systems, kiln firing processes and emissions reduction techniques
- products – storage and preparation
- packaging and dispatch.

The process of manufacturing white cement is similar to grey Portland cement production. The process includes the selection of raw materials, storage and preparation, fuel storage and preparation, firing of clinker in a kiln system, whitening/cooling, and grinding under precisely controlled conditions through the stages of the process in order to avoid contamination and undesired changes of the product. However, the combination of cooling and whitening is the main technological difference. These steps are used and needed in order to improve the whiteness of this special type of cement and to provide a uniform colour.

A typical process flow diagram from a cement plant is shown in Figure 1.4.



Source: [103, CEMBUREAU, 2006]

Figure 1.4: General overview of a cement manufacturing process

## 1.2.1 Raw materials and their winning

Naturally occurring calcareous deposits, such as limestone, marl or chalk, provide the source for calcium carbonate. Silica, iron oxide and alumina are found in various ores and minerals, such as sand, shale, clay and iron ore.

Winning of nearly all of the natural raw materials involves mining and quarrying operations. The materials are most often obtained from open surface quarries. The operations necessary include rock drilling, blasting, excavation, hauling and crushing. Useful information regarding mining/quarrying can be found in the Reference Document on Best Available Techniques for Management of Tailings and Waste-Rock in Mining Activities [47, European Commission, 2004].

The main raw materials, like limestone, chalk, marl and shale or clay, are extracted from quarries. In most cases, the quarry is close to the plant. After primary crushing, the raw materials are transported to the cement plant for storage and further preparation. Other raw materials, such as bauxite, iron ore, blast furnace slag or foundry sand, are brought in from elsewhere.

Raw materials have to show and meet characteristics, chemical elements and components which are necessary for the clinker burning process and they may affect the production process and clinker quality. Table 1.8 shows example ranges from chemical analyses and characteristics of raw materials and cement raw meals for the production of cement clinker. Apart from the main components, these raw materials also contain a number of metals that are listed in Table 1.9.

Components	Limestone, lime marl, chalk	Clay	Sand	PFA <sup>(2)</sup>	Fe source	Raw meal
	(mass %)					
SiO <sub>2</sub>	0.5 – 50	33 – 78	80 – 99	40 – 60	0.5 – 30	12 – 16
Al <sub>2</sub> O <sub>3</sub>	0.1 – 20	7 – 30	0.5 – 7	20 – 30	0.2 – 4	2 – 5
Fe <sub>2</sub> O <sub>3</sub>	0.2 – 5.9	4.0 – 15	0.0 – 4	5 – 15	50 – 93	1.5 – 2.5
Mn <sub>2</sub> O <sub>3</sub>	0.02 – 0.15	0.090	0.051	0.127	0.1 – 4	0.0 – 0.5
Fe <sub>2</sub> O <sub>3</sub> and Mn <sub>2</sub> O <sub>3</sub>	0.1 – 10	2 – 15	0.5 – 2		19 – 95	≤2
CaO	20 – 55	0.2 – 25	0.1 – 3	2 – 10	0.1 – 34	40 – 45
MgO	0.2 – 6	0.3 – 5	0.3 – 0.5	1.0 – 3	0.5 – 7	0.3 – 5
K <sub>2</sub> O	0 – 3.5	0.4 – 5	0.2 – 3	1 – 5	0.1 – 1	0.1 – 1.5
Na <sub>2</sub> O	0.0 – 1.5	0.1 – 1.5	0.0 – 1	0.2 – 1.5	0.1 – 1	0.1 – 0.5
SO <sub>3</sub> <sup>(1)</sup>	0.0 – 0.7	0.0 – 4	0.0 – 0.5	0.0 – 1	0 – 3	0 – 1.5
Cl	0.0 – 0.6	0.0 – 1	Traces		0.0 – 0.5	0.0 – 0.3
TiO <sub>2</sub>	0.0 – 0.7	0.2 – 1.8	0.0 – 0.5	0.5 – 1.5	0.0 – 3	0.0 – 0.5
P <sub>2</sub> O <sub>5</sub>	0.0 – 0.8	0.0 – 1.0	0.0 – 0.1	0.5 – 1.5	0.0 – 1	0.0 – 0.8
ZrO <sub>2</sub>		0.02				
CaCO <sub>3</sub>	96					
Loss on ignition (CO <sub>2</sub> + H <sub>2</sub> O), LOI 950 <sup>(3)</sup>	2 – 44	1 – 20	≤5	6.74	0.1 – 30	32 – 36

<sup>(1)</sup> Total content of sulphur, expressed as SO<sub>2</sub>  
<sup>(2)</sup> Pulverised fly ash  
<sup>(3)</sup> LOI 950 = loss on ignition  
Source: [60, VDI 2094 Germany, 2003], [81, Castle Cement UK, 2006], [90, Hungary, 2006], [103, CEMBUREAU, 2006]

**Table 1.8: Chemical analyses of raw materials and cement raw meal for the production of cement clinker**

Elements		Clay and argillite	Limestone, marl and chalk	Raw meal
		mg/kg DS <sup>(1)</sup>		
Antimony	Sb	No data available	1 – 3	<3
Arsenic	As	13 – 23	0.2 – 20	1 – 20
Beryllium	Be	2 – 4	0.05 – 2	0.1 – 2.5
Lead	Pb	10 – 40	0.3 – 21	4 – 25
Cadmium	Cd	0.02 – 0.3	0.04 – 0.7	0.04 – 1
Chromium	Cr	20 – 109	1.2 – 21	10 – 40
Cobalt	Co	10 – 20	0.5 – 5	3 – 10
Copper	Cu	No data available	3 – 12	6 – 60
Manganese	Mn	No data available	≤250	100 – 360
Nickel	Ni	11 – 70	1.5 – 21	10 – 35
Mercury	Hg	0.02 – 0.15	<0.01 – 0.13	0.01 – 0.5
Selenium	Se	No data available	1 – 10	<10
Tellurium	Te	No data available	<4	<4
Thallium	Tl	0.7 – 1.6	0.05 – 1.6	0.11 – 3
Vanadium	V	98 – 170	4 – 80	20 – 102
Tin	Sn	No data available	<1 – 5	<10
Zinc	Zn	59 – 115	10 – 40	20 – 47

<sup>(1)</sup> DS: dry substance  
Source: [60, VDI 2094 Germany, 2003]

**Table 1.9: Metals in raw materials and raw meal**

Waste also can replace conventional raw materials. Regarding the use of wastes as raw material see Section 1.2.4.2.

For white cement production, the availability of highly pure raw material, such as purity of Si, Ca and Al sources, is essential. Raw materials, e.g. highly pure limestone, types of white clays, kaolin, quartz sand, feldspar, diatomaceous earth, are selected with low contents of metals such as iron and manganese. The metal oxides influence the whiteness of the product and are one of the determining factors. For the production of high-grade white cement, the chemical composition of the raw materials is essential and examples are shown in Table 1.10. However, the proportions of these components also need to meet the requirements of the firing process. To improve the burnability, sometimes mineralisers are used. Mineralisers known and used are fluxing agents, such as fluorides (generally CaF<sub>2</sub>) [119, Sobolev, 2001], [120, Spain, 2007].

Raw materials	Chemical components in the raw materials (%)						
	Fe <sub>2</sub> O <sub>3</sub>	MgO	SiO <sub>2</sub>	TiO <sub>2</sub>	Al <sub>2</sub> O <sub>3</sub>	Cr <sub>2</sub> O <sub>3</sub>	Mn <sub>2</sub> O <sub>3</sub>
Limestone	<0.15	<0.015					
Clay	≤1.0	Traces	65 – 80	<0.8			
Kaolin (suitable)	0.4 – 1.0	0	70 – 73	0 – 0.80	18 – 20		
Quartz sand (pure)	≤0.2		<96				
Others <sup>(1)</sup>	<0.5	<3.0		<0.2		<30 ppm	<0.05

<sup>(1)</sup> Italy  
Source: [119, Sobolev, 2001], [120, Spain, 2007], [138, Italy, 2007]

**Table 1.10: Examples of chemical compositions of raw materials for white cement clinker production**

## 1.2.2 Raw materials – storage and preparation

Preparation of the raw materials is of great importance to the subsequent kiln system both in getting the chemistry of the raw feed right and in ensuring that the feed is sufficiently fine.

### 1.2.2.1 Storage of raw materials

The need to use covered storage depends on climatic conditions and the amount of fines in the raw material leaving the crushing plant. In the case of a 3000 tonnes/day plant these buildings may hold between 20 000 and 40 000 tonnes of material. An example of covered raw material storage is shown in Figure 1.5.



Source: [81, Castle Cement UK, 2006]

Figure 1.5: Example of covered raw material storage

The raw material fed to a kiln system needs to be as chemically homogeneous as practicable. This is achieved by controlling the feed into the raw grinding plant. When the material from the quarry varies in quality, initial preblending can be achieved by stacking the material in rows or layers along the length (or around the circumference) of the store and extracting it by taking cross-sections across the pile. When the material from the quarry is fairly homogeneous, simpler stacking and reclaiming systems can be used.

Raw materials used in relatively small quantities, mineral additions for example, may alternatively be stored in silos or bunkers. Any raw materials with potentially harmful properties to public health and to the environment must be stored and prepared according to individual specific requirements.

### 1.2.2.2 Grinding of raw materials

Accurate metering and proportioning of the mill feed components by weight is important for achieving a consistent chemical composition. This is essential for steady kiln operation and a high quality product. Metering and proportioning are also important factors in the energy efficiency of the grinding system. The predominant metering and proportioning equipment for raw material feed to mills is the apron feeder followed by the belt weigh feeder.

For white cement production, care has to be maintained during milling operations in order to prevent introduction of different pieces or small quantities of metals providing colour.

Furthermore, the selection of grinding media and mill liners is important in order to avoid contamination of the raw mix with iron. Special steels or ceramic materials are used for the essential parts of the equipment. To improve the whiteness, humidity control of the raw mix is used and the grinding time is reduced by using any accelerating/surface active admixtures, which, however, could be different from commercially available grinding aids [120, Spain, 2007]. In some cases, granulating equipment is recommended for the final stage of the raw mix preparation process, especially when using a fluidised bed kiln for firing [119, Sobolev, 2001].

### 1.2.2.2.1 Grinding of raw materials – dry and semi-dry kiln systems

The raw materials, in controlled proportions, are ground and mixed together to form a homogeneous blend with the required chemical composition. For dry and semi-dry kiln systems, the raw material components are ground and dried to a fine powder, making use mainly of the kiln exhaust gases and/or cooler exhaust air. For raw materials with a relatively high moisture content, and for start-up procedures, an auxiliary furnace may be needed to provide additional heat.

Typical dry grinding systems used are:

- tube mill, centre discharge
- tube mill, airswept
- vertical roller mill
- horizontal roller mill (only a few installations in operation).

Other grinding systems are used to a lesser extent. These are:

- tube mill, end discharge in closed circuit
- autogenous mill
- roller press, with or without crushers (dryers).

The fineness and particle size distribution of the product leaving a raw grinding system is of great importance for the subsequent burning process. The target given for these parameters is achieved by adjusting the separator used for classifying the product leaving the grinding mill. For dry classification, air separators are used. The newest generation, rotor cage type separators, have several advantages. These are:

- lower specific energy consumption of the grinding system (less over-grinding)
- increased system throughput (efficiency of particle separation)
- more favourable particle size distribution and product uniformity.

### 1.2.2.2.2 Grinding of raw materials – wet or semi-wet kiln systems

Wet grinding is only used in combination with wet or semi-wet kiln systems. The raw material components are ground with added water to form a slurry. To achieve the slurry fineness required and in order to comply with modern quality demands, closed circuit milling systems are the main option.

The wet process is normally preferred whenever the raw material has a moisture content of more than 20 % by weight. Raw materials such as chalk, marl or clay, which are sticky and have an inherently high moisture content, are soft and as a first stage of preparation they may be ground in a wash mill. Water and crushed material are fed to the wash mill and broken down into slurry by shearing and impact forces imparted by the rotating harrows. When sufficiently fine, the material passes through screens in the wall of the wash mill and is pumped to storage. To achieve the required slurry fineness, further grinding in a tube mill is usually required, especially if an additional raw material such as sand is to be added.

To reduce kiln fuel consumption, water addition during raw material grinding is controlled so that the amount used is the minimum necessary to achieve the required slurry flow and pumpability characteristics (32 to 40 % w/w water). Chemical additives may act as slurry thinners permitting the water content to be reduced.

### 1.2.2.2.3 Raw meal or slurry homogenisation and storage

Raw meal or slurry leaving the raw grinding process requires further blending/homogenisation to achieve optimum consistency of the raw mix prior to being fed to any type of kiln system. The raw meal is homogenised and stored in silos, the raw slurry in either tanks or silos.

For raw meal transport to storage silos, pneumatic and mechanical systems are used. Mechanical conveyors normally require a higher investment cost but have much lower operating costs than pneumatic conveying systems. A combination of air-slide or screw/chain conveyors with a belt bucket elevator is the most commonly used conveying system.

## 1.2.3 Fuels – storage and preparation

Various fuels (conventional and waste) can be used to provide the heat and the energy required for the process. Different types of conventional fuels are mainly used in cement kiln firing; such as:

- solid fuels, e.g. coal as well as petcoke and lignite, and in some cases oil shale
- liquid fuels, e.g. fuel oil including highly viscous fuel oil (HVFO)
- gaseous fuels, e.g. natural gas.

The main ash constituents of these fuels are silica and alumina compounds. Furthermore, ashes may also contain traces of metals. These combine with the raw materials to become part of the clinker. This needs to be allowed for in calculating the raw material proportion and so it is desirable to use fuel with a consistent, though not necessarily low, ash content. Examples of chemical analyses of metals in coal used in Germany are shown in Table 1.11.

Elements		Hard coal/brown coal
		mg/kg DS <sup>(1)</sup>
Antimony	Sb	0.4 – 2
Arsenic	As	1 – 50
Beryllium	Be	<0.1 – 3.3
Lead	Pb	1.5 – 273
Cadmium	Cd	<0.1 – 10
Chromium	Cr	1.5 – 81
Cobalt	Co	<1 – 40
Copper	Cu	1 – 100
Manganese	Mn	82 – 250
Nickel	Ni	<1 – 100
Mercury	Hg	0.1 – 3.3
Selenium	Se	0.6 – 2
Tellurium	Te	0.2 – 1
Thallium	Tl	0.1 – 5.5
Vanadium	V	1 – 200
Tin	Sn	0.8 – 2.3
Zinc	Zn	6 – 220
<sup>(1)</sup> DS: dry substance		
Source: [60, VDI 2094 Germany, 2003]		

**Table 1.11: Chemical analyses of metals in coal**

The main fossil fuels used in the European cement industry are petcoke and coal. Costs normally preclude the use of natural gas or oil, but the selection of fuels depends on the local situation (such as the availability of domestic coal). However, the high temperatures and long residence times in the kiln system implies considerable potential for the destruction of organic substances (see Section 1.2.4.1). This makes a wide variety of less expensive fuel options possible, in particular different types of wastes. The use of wastes has been increasing over the last few years (see Section 1.2.4).

In order to keep heat losses to a minimum, cement kilns are operated at the lowest reasonable excess oxygen levels. This requires highly uniform and reliable fuel metering and fuel presentation in a form allowing easy and complete combustion. These conditions are fulfilled by all liquid and gaseous fuels. For pulverised solid fuels, good design of hoppers, conveyors and feeders is essential to meet these conditions. The main fuel input (65 – 85 %) usually consists of easily combustible fuel, whereas the remaining 15 – 35 % may be fed in coarsely crushed or lump form.

For white cement production, fuel selection has to be made very carefully in order to avoid elements in the fuel ash that could be incorporated in the clinker and could therefore alter the desired colour of the white cement. In 2007, selected waste fuels were used on a limited scale for white cement production.

### 1.2.3.1 Storage of conventional fuels

Raw coal and petcoke are stored similarly to raw materials; thus, in many cases, in covered stores. Outside storage in large, compacted stockpiles is used for long term stocks. Such stockpiles may be seeded with grass to prevent rainwater and wind erosion. Drainage to the ground from outside storage has shown to be a problem. However, sealed concrete floors under the stockpiles make it possible to collect and clean the water that drains off. Normal good practice in terms of compaction and stockpile height needs to be observed when storing coal with a relatively high volatile matter content in order to avoid the risk of spontaneous ignition when stored for long periods.

Pulverised coal and petcoke are stored exclusively in silos. For safety reasons (i.e. the danger of explosions being triggered by smouldering fires and static electricity spark-overs), these silos have to be of the mass flow extraction type and have to be equipped with standard safety devices.

Fuel oil is stored in vertical steel tanks. These are sometimes insulated to help keep the oil at a pumpable temperature (50 to 60 °C). They may also be equipped with heatable suction points to maintain the oil at the correct temperature locally.

Natural gas is not stored at the cement plant. The international high pressure gas distribution network acts as a gas storage facility.

### 1.2.3.2 Preparation of conventional fuels

Solid conventional fuel preparation (crushing, grinding and drying) is usually carried out on site. Coal and petcoke are pulverised to about raw meal fineness in grinding plants using equipment similar to the raw material grinding plants. The fineness of the pulverised fuel is important – too fine and flame temperatures can be excessively high, too coarse and poor combustion can occur. Low volatility or low volatiles contents of the solid fuel will need finer grinding. If sufficient hot air for drying is not available from the kiln or from the cooler, an auxiliary furnace may be needed. Special features have to be incorporated to protect the equipment from fires and explosions.



Three main types of coal milling and grinding systems are used:

- tube mill, airswept
- vertical roller or ring-ball mill
- impact mill.

Ground solid fuel may be fired directly into the kiln, but in modern installations it is usually stored in silos to allow the use of more thermally efficient burners (indirect firing) using low primary air.

Solid fuel grinding, storage and firing systems have to be designed and operated so as to avoid the risk of explosion or fire. The primary requirements are to control air temperatures properly, and to avoid the accumulation of fine material in dead spots exposed to heat.

Fuel oil preparation: In order to facilitate metering and combustion, the fuel oil is brought to 120 – 140 °C, resulting in a viscosity reduction to 10 – 20 cSt. Additionally, the pressure is increased to 20 – 40 bar.

Natural gas preparation: Prior to combustion the gas pressure has to be brought from the pipeline pressure of 30 – 80 bar down to the plant's network pressure of 3 – 10 bar and then reduced again to the burner's supply pressure of around 1 bar (overpressure). The first pressure reduction step is accomplished in the gas transfer station where consumption metering also takes place. To avoid freezing of the equipment as a result of the Joule-Thompson effect, the natural gas is preheated before passing through the pressure reduction valve.

Alternatively, the pressure reduction can be accomplished by passing the gas through a gas expansion turbine connected to a power generator. Thus, some of the energy required for gas compression can be recovered.

## 1.2.4 Use of waste

The European cement industry recovers a substantial amount of waste-derived fuels, which replace fossil fuels up to a level of more than 80 % in some plants. This enables the cement industry to contribute further to the reduction of greenhouse gas emissions and to the use of fewer natural resources.

The ban on the landfilling of unprocessed waste in some EU Member States has led to an increasing number of mechanical and mechanical biological waste treatment plants being put into operation. As a consequence, the utilisation of pretreated waste fractions is an issue of growing concern. After suitable treatment, individual waste fractions can meet the requirements for environmentally compatible re-use in cement plants. The cement industry of the EU-27 has been involved in the recovery of selected waste streams in cement plants for many years. This industry, traditionally a substantial user of non-renewable natural resources, minerals and fossil fuels, is committed to using waste for the conservation of these resources without, at the same time, producing final wastes [103, CEMBUREAU, 2006], [168, TWG CLM, 2007].

Since waste treatment is not covered in this document, useful information regarding waste treatment can be found in the Reference Document on the Best Available Techniques for the Waste Treatments Industries. Furthermore, the requirements of existing European and national regulations have to be considered **in particular** when co-incinerating waste.

### 1.2.4.1 General aspects

Different types of waste materials can replace primary raw materials and/or fossil fuels in cement manufacturing and will contribute to saving natural resources. Basically, characteristics

of the clinker burning process itself allow environmental beneficial waste-to-energy and material recycling applications. The essential process characteristics for the use of waste can be summarised as follows:

- maximum temperatures of approx. 2000 °C (main firing system, flame temperature) in rotary kilns
- gas retention times of about 8 seconds at temperatures above 1200 °C in rotary kilns
- material temperatures of about 1450 °C in the sintering zone of the rotary kiln
- oxidising gas atmosphere in the rotary kiln
- gas retention time in the secondary firing system of more than 2 seconds at temperatures of above 850 °C; in the precalciner, the retention times are correspondingly longer and temperatures are higher
- solids temperatures of 850 °C in the secondary firing system and/or the calciner
- uniform burnout conditions for load fluctuations due to the high temperatures at sufficiently long retention times
- destruction of organic pollutants due to the high temperatures at sufficiently long retention times
- sorption of gaseous components like HF, HCl, SO<sub>2</sub> on alkaline reactants
- high retention capacity for particle-bound heavy metals
- short retention times of exhaust gases in the temperature range known to lead to 'de-novo-synthesis' of PCDD/F
- complete utilisation of fuel ashes as clinker components and hence, simultaneous material recycling (e.g. also as a component of the raw material) and energy recovery
- product specific wastes are not generated due to a complete material utilisation into the clinker matrix; however, some cement plants in Europe dispose of bypass dust
- chemical-mineralogical incorporation of non-volatile heavy metals into the clinker matrix [60, VDI 2094 Germany, 2003], [76, Germany, 2006], [168, TWG CLM, 2007].

Investigations show that in rotary kilns hazardous substances are better absorbed by material and clinker than in other types of kilns, e.g. shaft kilns [75, Estonia, 2006], [76, Germany, 2006].

A wide range of different types of wastes are used as raw materials and/or as fuels. Before considering the use of waste materials, different basic principles have to be considered, such as appropriate selection of waste materials and an extensive analysing procedure of wastes and pretreatment. Treatment of these wastes has to be carried out in order to keep quality standards of the clinker, because the fuel ashes are fully captured in the clinker. The decision on what type of waste can finally be used in a certain plant cannot be answered uniformly.

Considerations and decisions have to be based on the clinker production process and the operation conditions, the raw materials and fuel compositions, the feeding points, the flue-gas cleaning technique used, the given waste management problems and the requirements of existing European and national regulations.

As a basic rule, wastes accepted as fuels and/or raw materials must give the following added value to the cement kiln:

- calorific value from waste material
- material value from waste material.

Furthermore, volumes and categories of wastes have to be considered as well as physical and chemical compositions, characteristics and pollutants. Waste-derived fuels used by the cement industry are derived exclusively from selected waste streams, which usually require a pretreatment, e.g. shredding, blending, grinding and homogenisation, and an appropriate quality assurance. Preparation of waste materials is usually carried out at waste treatment plants.

### *Feed points for inserting waste into the kiln*

Wastes used as raw materials are typically fed to the kiln system in the same way as conventional raw materials, e.g. via the normal raw meal supply.

As described in Section 1.2.5.1, different feed points can be used to insert fuels into the cement kiln. These feed points can also be used for feeding wastes as fuels and/or raw materials into the cement production process. It has to be noted that the way the fuels are fed into the kiln is very important because this can have an effect on the emissions. Of these feed points, there is, in general, only one way in which the flue-gases from fuels pass the highest temperature zone of the kiln, namely by feeding them through the main burner. Related to other feed points, temperature and residence time depends on kiln design and kiln operation, as described above.

Wastes, which are fed through the main burner, will be decomposed in the primary burning zone, at high temperatures of up to 2000 °C. Multi-channel burners are designed for the use of different types of fuels including waste fuels. Wastes fed to a secondary burner, preheater or precalciner will be burned at lower temperatures, which is not always enough to decompose halogenated organic substances. Volatile components in material that is fed at the upper end of the kiln or as lump fuel can evaporate. These components do not pass the primary burning zone and may not be decomposed or bound in the cement clinker. Therefore, the use of waste containing volatile metals (mercury, cadmium, thallium) or volatile organic compounds can result in an increase of the emissions of mercury, cadmium, thallium or organic emissions (e.g. VOCs) when improperly used. Consideration should be given to these waste materials containing components that can be volatilised at lower temperatures before the calcining zone (e.g. hydrocarbons, solvents, waste oils). They have to be fed into the adequately high temperature zones of the kiln system.

### *Energy efficiency by using waste*

The cement industry has achieved an improvement in energy efficiency regarding fuels used in the cement manufacturing processes and will continue to develop alternative means for improvements. However, the calorific values of the waste fuels which are used in the process are very important quality requirements necessary to receive an improvement in energy efficiency and a positive input to the thermal process that supports calcination [76, Germany, 2006], [89, ERFO, 2005], [103, CEMBUREAU, 2006].

### *Impacts by using wastes*

Information about impacts on the emissions behaviour by using waste materials can be found in Section 1.3.4.13 and information about impacts on product quality can be found in Section 1.3.4.14 of this document.

The monitoring of parameters and emissions for using wastes as fuels and/or raw materials can be found in Section 1.3.9. Furthermore, plant specific data for, e.g. using wastes, can be found in Section 6.2.2 of this document.

## **1.2.4.2 Use of wastes as raw materials**

The chemical suitability of wastes used as raw materials is important and they have to provide the constituents required for the production of clinker. Primary desired chemical elements are lime, silica, alumina and iron as well as sulphur, alkalis and others which can be classified into different groups according to their chemical composition. The use of wastes as raw materials as in the clinker burning process involves the substitution of sulphur and the oxides contained in the wastes used as raw materials. These include calcium oxide (CaO), silica (SiO<sub>2</sub>), alumina (Al<sub>2</sub>O<sub>3</sub>) or iron oxide (Fe<sub>2</sub>O<sub>3</sub>) for the respective raw material constituents. Power station ash (fly ash), blast furnace slag, and other process residues can be used as partial replacements for the

natural raw materials. Table 1.12 shows the types of wastes most frequently used as raw materials in the production of cement in Europe in 2006.

Fly ash	Blast furnace slag	Silica fume
Iron slag	Paper sludge	Pyrite ash
Spent foundry sand	Soil containing oil	
Artificial gypsum (from flue-gas desulphurisation and phosphoric acid production)		
<i>Source:</i> [8, CEMBUREAU, 2001], [91, CEMBUREAU, 2006]		

**Table 1.12: Types of waste frequently used as raw materials in the European cement industry**

Other waste materials are supplied as so-called ‘inter-ground’ additions to the grinding plants. Fly ash can be used both as raw material in the production of clinker (mainly for its content of alumina) and as an inter-ground addition for cement. Fly ash can replace up to 50 % of the Portland cement clinker; however, it may contain mercury. Furthermore, suitable industrial gypsum lends itself for use as a sulphate component. An overview of wastes used as raw materials classified into different groups according to their chemical composition is shown in Table 1.13.

Raw material group	Examples of wastes used as raw materials
Ca group	Industrial lime (waste limestone) Lime slurries Carbide sludge Sludge from drinking water treatment
Si group	Spent foundry sand Sand
Fe group	Blast furnace and converter slag Pyrite ash Synthetic hematite Red mud
Al group	Industrial sludge
Si-Al-Ca group	Fly ash Slags Crusher fines Soil
S group	Industrial gypsum
F group	CaF <sub>2</sub> Filter sludge
<i>Source:</i> [76, Germany, 2006], [91, CEMBUREAU, 2006], [103, CEMBUREAU, 2006]	

**Table 1.13: Example list of wastes used as raw materials classified to their chemical composition and used in cement kilns in the EU-25**

Like ash from conventional fuels, the ash from waste fuels provides mineral components for the cement clinker. The ternary diagram in Figure 1.6 shows the composition of different fuel ash and wastes used as raw materials, for which the contents of the main components CaO, SiO<sub>2</sub>, Fe<sub>2</sub>O<sub>3</sub> and Al<sub>2</sub>O<sub>3</sub> are represented. As shown, the clinker has a defined composition which is crucial to the characteristic hydraulic properties of the cement. This means that all raw materials and fuel ash must be carefully matched in terms of mineral composition and feed rate to obtain the desired clinker composition.

The wastes used as raw materials enter the clinker burning process or the calciner via the raw meal path or via the kiln inlet and/or the calciner. During the preheating phase in the preheater, organic components may be released from the kiln feed, because of lower temperatures, which are not always enough to decompose halogenated organic substances. When processing these

waste raw materials, these must be checked for potential emissions of volatile organic constituents and the feed point selected accordingly, e.g. kiln burner.

Spent foundry sand with a high volatile content, for example, should be fed to the kiln inlet. The residual organic binder used in chemically bonded sand cast systems can be decomposed in the preheater. However, a short residence time of the material in the low temperature phase of the preheater ensures that volatiles are not emitted. Pretreatment of spent foundry sand, such as the separation of dust, can reduce the content of heavy metals. By using industrial gypsum and fly ash, the feeding of gypsum takes place in the grinding plant. The recoverable calorific value of carbon rich ash, i.e. up to 20 % of carbon is possible, can be used in the cement clinker process [76, Germany, 2006], [91, CEMBUREAU, 2006], [168, TWG CLM, 2007].

Requirements to consider in the selection and use of waste as raw material:

- the waste consists primarily of the clinker components
- low volatile heavy metal concentration, i.e. mercury, thallium and other types of metals have to be taken into account
- regular monitoring of inputs, e.g. used waste materials by sampling and analysis.

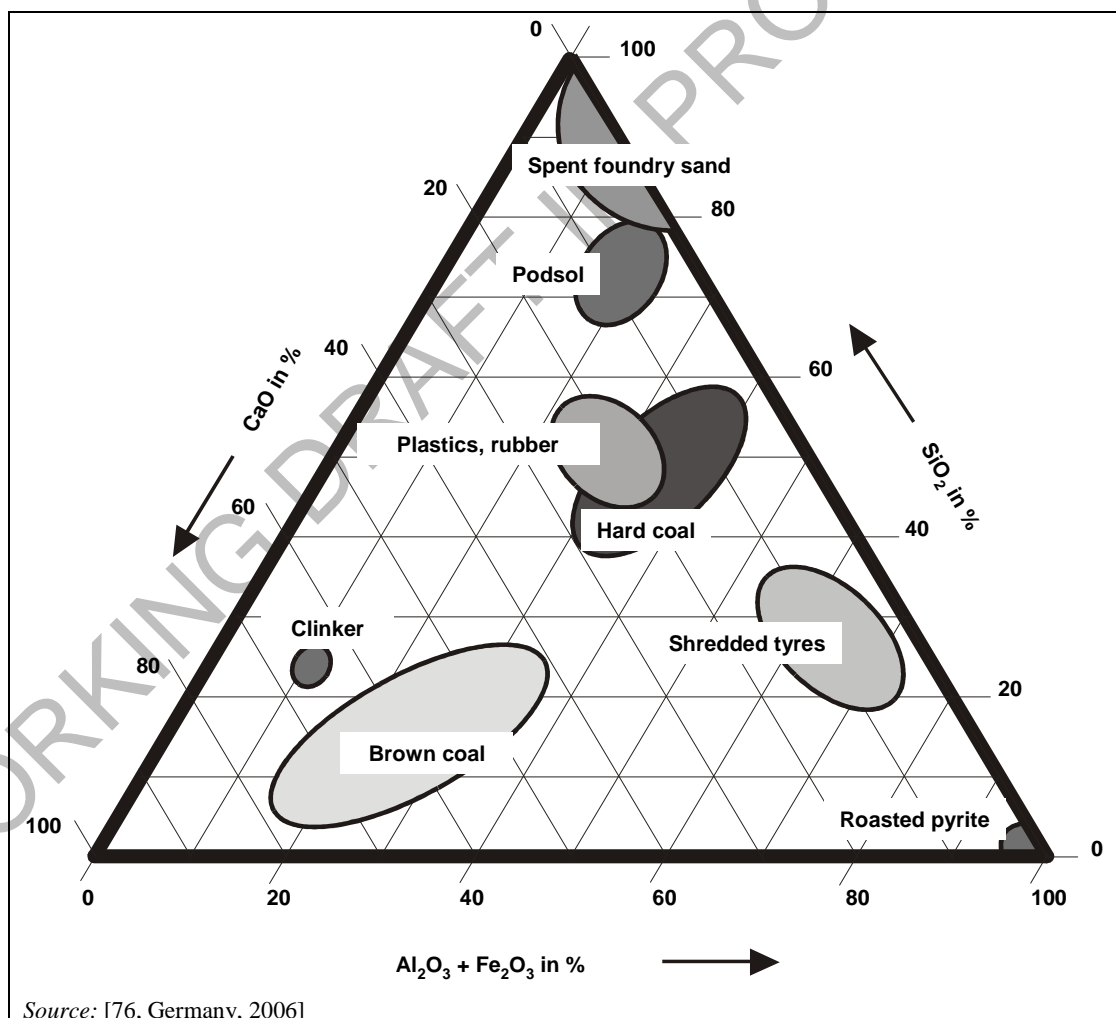


Figure 1.6: Ternary  $\text{CaO}$ ,  $\text{SiO}_2$  and  $\text{Al}_2\text{O}_3 + \text{Fe}_2\text{O}_3$  diagram for cement clinker and the ash constituents of different raw materials and fuels

### 1.2.4.3 Use of wastes as fuels

Conventional fuels, such as fossil fuels, can be replaced by waste fuels, i.e. waste fuels derived from pretreated and sorted waste fractions including solid and liquid recovered fuels, and/or biomass. A wide range of different types of wastes are used as fuels including the remaining ashes. Waste materials can be solid, liquid or pasty and are defined by their origin, e.g. industrial, agricultural and municipal sources. Consumption of waste fuels is described in Section 1.3.3.3 and impacts on the emissions behaviour are described in Section 1.3.4.13.

#### 1.2.4.3.1 Types of waste fuels

The clinker burning process offers good conditions for using different types of waste materials replacing parts of conventional fuels (see Section 1.2.4.1). As listed in Table 1.14, different types of wastes are used as fuels in European cement kilns which are categorised as hazardous and non-hazardous wastes. As these calorific waste materials can replace primary fuel in cement kilns, a consistent waste quality is essential (e.g. adequate calorific value, metal, halogen (e.g. chlorine) and ash content, the waste has to be suitable for the burners). There is a constant increase in the use of waste fuels in clinker production; however, the increase in the use of non-hazardous waste is more significant than in the use of hazardous waste [74, CEMBUREAU, 2006], [75, Estonia, 2006], [76, Germany, 2006], [92, Austria, 2006].

Table 1.14 presents a list of the use of waste fuels clustered into 14 groups. These groups span several EWC listings and a full list of the whole grouping structure along with waste categories and waste descriptions can be found in Table 6.1 of Section 6.2.1. Furthermore, examples of calorific values of several types of wastes can be found in Table 1.20 of Section 1.3.3.3 [74, CEMBUREAU, 2006], [98, European Commission, 2000], [103, CEMBUREAU, 2006], [168, TWG CLM, 2007] [192, CEMBUREAU, 2012].

Group Nr. <sup>(1)</sup>	Types of waste fuels (hazardous and non-hazardous)
1	Wood, paper, cardboard
2	Textiles
3	Plastics
4	Processed fractions (e.g. RDF)
5	Rubber/tyres
6	Industrial sludge
7	Municipal sewage sludge
8	Animal meal, fats
9	Coal/carbon waste
10	Agricultural waste
11	Solid waste (impregnated sawdust)
12	Solvents and related waste
13	Oil and oily waste
14	Others
<sup>(1)</sup> Each grouping spans several EWC listings, see Table 6.1 in Section 6.2.1 Source: [74, CEMBUREAU, 2006], [168, TWG CLM, 2007]	

**Table 1.14: Different types of wastes used as fuels in EU-27 cement kilns in 2003 and 2004**

## 1.2.4.3.1.1 Solid waste fuels

Not every combustible solid waste is suitable as fuel in the clinker burning process. Solid waste can be a homogenous or an inhomogeneous mixture of very diverse origins and components, such as:

- combustible fractions, e.g. paper, cardboard, plastics, rubber, and wood residues
- varying amounts of inert materials containing organic fractions, e.g. sand, stone, ceramics, ferrous/non-ferrous metals and organic wet materials
- hazardous fractions, e.g. tar, resins, impregnated sawdust, or non-hazardous materials.

Waste, like mixed municipal waste, mixed commercial waste or mixed construction, demolition waste and some solid hazardous waste has to be pretreated in waste management facilities before being used as fuels. The extent of the waste treatment operation, such as sorting, crushing, and pelletising, depends on the waste fuel application.

Solid fuel preparation techniques vary considerably depending on the source and type of the waste, and on the requirements of the cement industry. One important requirement results from the used transfer and firing system to convey waste fuel into a kiln:

- the main firing system (at the kiln head/outlet, injection of waste fuels via lances): highly abrasive wastes such as dried sludge and unusual particle shapes and sizes can produce operational problems. When pneumatic transfer systems are used to convey solid waste fuel in the kiln, plugging and damage to rotating parts can be avoided (the system functions entirely without moving parts). The amount of conveying air injected into the kiln along with the waste is negligible in terms of kiln combustion stoichiometry. Greater particle sizes dictate large pneumatic conveyor lines and blowers. Therefore, important processing steps are the size reduction and the soft pelletising of the waste fuel. (Typically, the particle size is no larger than 25 mm). The advantage of compacting by soft pelletising is the improvement of flow and dosage characteristics of the fuel
- the secondary firing system (the fuel is fed via the kiln inlet, the riser between the rotary kiln inlet and the lowest cyclone stage or the calciner): the size restriction for solid waste fuels is not important for the secondary firing system. Even whole tyres can be introduced via the kiln inlet or via mid kiln technology. Furthermore, waste with a high ash content can be used.

Different types of solid wastes are used, e.g.:

- non-hazardous waste as listed in Table 1.14, group number 1 – 10
- hazardous waste listed in Table 1.14, group number 11 – 13.

Figure 1.7, Figure 1.8 and Figure 1.9 show examples of pretreated waste mixtures used in cement plants, such as:

- hazardous waste impregnated sawdust
- waste fuel based on paper, textiles both pre and post consumer which is manufactured from polythene film, photographic film, paper, polypropylene, packaging materials and plastics
- waste fuel consisting of household waste, screened paper, cardboard, wood, carpet, textiles and plastics which is a solid, clean and non-hazardous fuel.

The wastes are analysed and especially prepared for the use in cement kilns [45, Schorcht, 2006], [81, Castle Cement UK, 2006], [107, Belgium, 2006].



**Figure 1.7: Hazardous waste – impregnated sawdust**

Source:[168, TWG CLM, 2007]



**Figure 1.8: Specially prepared waste fuel based on, e.g. paper, plastics, textiles**

Source:[81, Castle Cement UK, 2006]



**Figure 1.9: Specially prepared household waste used as fuel in cement kilns**

Source:[82, CEMEX Rugby UK, 2006]

#### 1.2.4.3.1.2 Liquid waste fuels

Liquid waste fuels can be prepared by blending or pretreating different wastes like used solvents, paint residues or waste oil with suitable calorific values in special waste management facilities. More useful information regarding waste treatment can be found in the Reference Document on the Best Available Techniques for the Waste Treatments Industries [48, European Commission, 2005].

Consideration has to be given to some liquid hazardous wastes (e.g. solvents) when handling liquid waste fuels, e.g. storage, feeding, in order to avoid emissions of organic compounds. Several techniques exist, e.g. vapour recovery which is used where required. Vapour recovery systems are operated in a way which ensures that the flow of organic substances is permitted only upon connection of the vapour recovery system, and that the vapour recovery system and attached facilities release no gas to the air during normal operation, with the exception of releases necessary for safety reasons [76, Germany, 2006], [81, Castle Cement UK, 2006], [168, TWG CLM, 2007].

#### 1.2.4.3.2 Quality requirements of waste and input control

Waste materials used as raw materials and/or as fuels in cement kilns have to reach different quality standards because they are fully captured in the clinker and to minimise negative effects on air emissions. A constant waste quality is essential. To guarantee the characteristics of the waste fuel, a quality assurance system is required. In particular, this includes provisions for the sampling, the sample preparation, the analysis and the external monitoring. More useful information can be found in the technical specifications of the European Committee for Standardisation, such as CEN/TC 343 ‘Solid Recovered Fuels’. Furthermore, the requirements of existing European and national regulations have to be considered. When co-incinerating waste, the requirements of **Chapter IV of and Annex VI to the Directive 2010/75/EU** have to be met, e.g. requirements regarding reception procedures carried out by the operator when using hazardous waste. As a basic rule for quality requirements, wastes accepted as fuels and/or raw materials have to give the following added values to the cement kiln:

- calorific value from waste material
- material value from waste material.

Waste with adequate calorific value can replace primary fuel in cement kilns. It has to be noted that the calorific values of these wastes vary widely (see Section 1.3.3.3).

Preparation of different types of combustible wastes or wastes with separable calorific fractions for use as fuel is usually performed outside the cement plant. These wastes are normally



prepared by the supplier or by waste treatment specialists' organisations in special waste management facilities in such a way that they can directly be used in cement kilns without any additional treatment on the cement plant. Additionally, before being used in the cement kiln, the delivered waste material is checked and analysed regularly by the cement plant personnel as well. Special laboratory equipment is used for checking different quality characteristics.

The techniques used to prepare and blend certain waste fuel qualities depend on the characteristics of the material input and the requirements of the users. Even waste materials like production specific wastes, are treated and blended prior to use in waste facilities to ensure a homogeneous mixture with nearly constant qualities, such as thermal properties and chemical composition. Only in some cases can wastes be just used as they are delivered without further processing, for example used tyres or used oil. Any inhomogeneous wastes, like mixed solid wastes from different sources or separated fractions from mixed municipal waste, require higher monitoring efforts to attain a reliable quality with a constant low pollutant input.

Important characteristics and parameters for waste fuels are calorific value along with a content of water, ash, sulphur, chlorine and heavy metals (especially mercury, cadmium and thallium). Additionally, the suitability for the burners is important. Chlorine may have a negative impact on the production process. The acceptable chlorine concentration therefore depends on the individual situation on site; however, this concentration is kept as low as possible in order to avoid operational problems in the kiln system, e.g. blockage in the preheater. In cases when a high volume of chlorine is input, usually a chlorine bypass might be necessary to avoid corrosion, blockings, shutdown, etc. (see Section 1.2.5.4.1). Typical chlorine concentrations range from <math>0.5 - 2\%</math>. Individual systems and specifications have been developed in the EU-27 to assess and control the suitability of waste fuels, e.g. lists have been developed of maximum pollutant values allowed for selected wastes to be used for the clinker burning process. Plant specific aspects have been taken into consideration for the specifications which are based both on requirements of plant specific processes and permits. Furthermore, specifications determine technical norms for delivering liquid waste fuels. An example of an internal specification for waste fuels is described in Section 6.2.2.1 and Table 6.9. Furthermore, examples of input criteria for different substances for suitable waste fuels being accepted in some EU countries are given in Section 6.2.2.1.1.

Other systems used are mainly focused on the content of metals (see Section 1.2.4.3.2.1). It has to be noted that other materials can be used as well which do not meet all of these conditions. In the case of using sewage sludge or wood waste, the mercury input has to be monitored regularly because of the possible mercury emissions.

Furthermore, the waste fuel has to be available in a sufficient quantity. Source selection is the first action to take into account for mono streams to reduce materials that might cause operation or quality problems in the cement process.

The quality requirements of the products should be considered regarding the selection of fuels (conventional or waste). There are consequently limits on the types and amounts of waste fuels suitable for use in the production of cement which is highly dependent on site-specific circumstances [75, Estonia, 2006], [76, Germany, 2006], [89, ERFO, 2005], [103, CEMBUREAU, 2006], [168, TWG CLM, 2007].

Useful information regarding waste treatment can be found in the Reference Document on Best Available Techniques for the Waste Treatments Industries, where, e.g. examples of specifications of a waste that can be accepted as fuel in some countries' cement kilns are described [48, European Commission, 2005].

### 1.2.4.3.2.1 Metal concentrations of wastes

Concentrations of metals vary with the waste origin. In many European countries, regulators and/or industry have produced lists of the maximum allowable substance values for different wastes that can be used as fuels and/or raw materials. Examples of typical metal concentration ranges and typical input criteria regarding different substances for suitable waste fuels from different countries in Europe can be found in Section 6.2.2.1.1. Different values may also be found in other authorised environmental performance covering specific wastes. However, no agreed threshold limit value exists, as different criteria are applied, depending on the local situation. The criteria applied may include:

- national environmental policies and legislation
- significance of the impact of the cement industry in the context of regional industrial development
- efforts to harmonise regional environmental laws and standards
- levels of substances in traditional raw materials and wastes
- plant conditions and emissions
- treatment alternatives for available wastes
- required minimum calorific values
- requirements for cement quality.

### 1.2.4.3.3 Storage and handling of waste

Usually, waste fuels are prepared in special waste management facilities. The delivered wastes need to be stored at the cement plant and then proportioned for feeding to the cement kiln. Since supplies of waste suitable for use as fuel tend to be variable whilst waste material markets are rapidly developing, it is advisable to design multipurpose storage/preparation plants.

Liquid waste fuels are mostly hazardous wastes. This has to be taken into account when handling liquid waste fuels, e.g. storage, feeding (see Section 1.2.4.3.1.2) [76, Germany, 2006]. Furthermore, safety management for potentially self igniting materials may be considered when using waste fuels derived from pretreated and sorted waste fractions.

Useful information regarding storage of materials can also be found in the Reference Document on Best Available Techniques on Emissions from Storage [96, European Commission, 2006].

## 1.2.5 Clinker burning

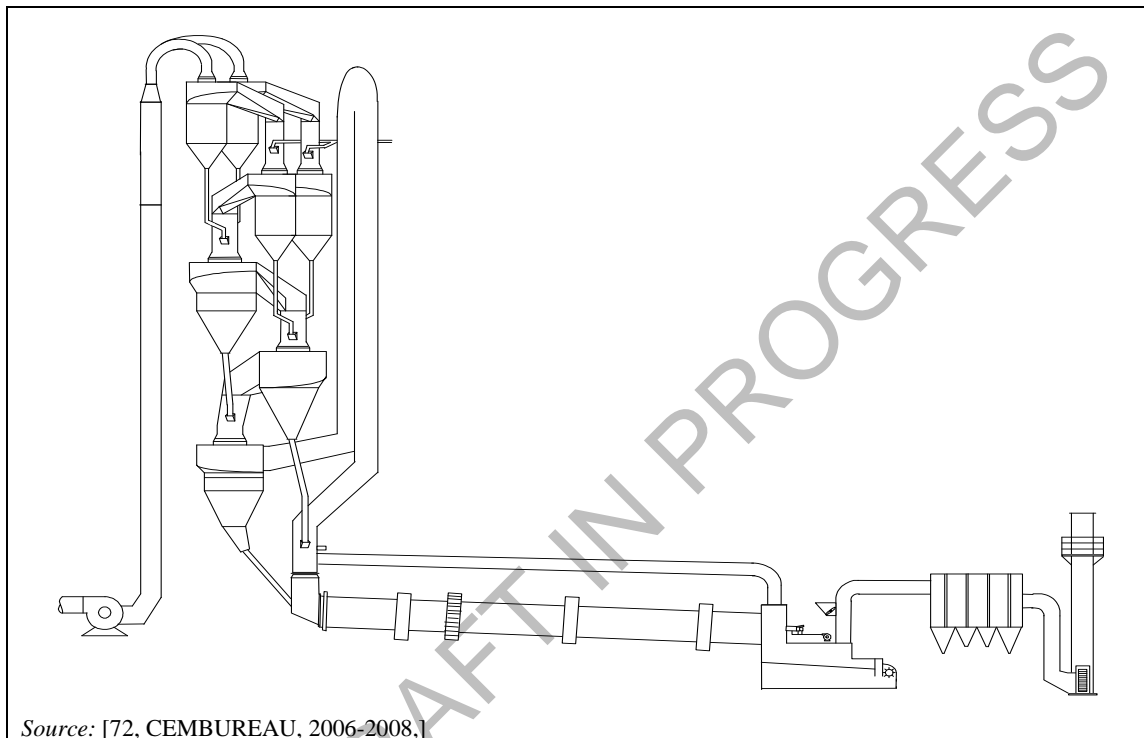
This part of the process is the most important in terms of emissions potential and of product quality and cost. In clinker burning, the raw meal (or raw meal slurry in the wet process) is fed to the rotary kiln system where it is dried, preheated, calcined and sintered to produce cement clinker. The clinker is cooled with air and then stored.

In the clinker burning process, high process temperatures are required to convert the raw material mix into cement clinker. It is essential to maintain kiln charge temperatures in the sintering zone of the rotary kilns at between 1400 and 1500 °C, and the flame temperature at about 2000 °C. Also, the clinker needs to be burned under oxidising conditions. Therefore, an excess of air is required in the sintering zone of a cement clinker kiln.

For white cement production, the firing process leads to temperatures in the sintering zone of up to 1600 °C, depending on the composition of the raw material mix and the desired composition of the final product. Flame temperatures of higher than 2000 °C are required because of the absence of fusing elements in the raw materials which could alter the colour of the product. Generally, reducing conditions are kept in order to avoid oxidation of some elements that could colour the clinker. Furthermore, the selection of a no-ash fuel and talc-magnesite or other

magnesite based refractories with spinel binder is essential to avoid the contamination of the clinker. The quality of a white cement is strongly affected by the production technique [119, Sobolev, 2001], [120, Spain, 2007], [138, Italy, 2007].

Since the rotary kiln was introduced in around 1895 it has become the central part of all modern clinker producing installations. The vertical shaft kiln is still used for the production of lime, but only in a few countries is it in use for the production of cement clinker, and in these cases only at small-scale plants.



**Figure 1.10:** Schematic view of a preheater/precalciner/grate cooler kiln

The first rotary kilns were long wet kilns, where the whole heat consuming thermal process takes place in the kiln itself. With the introduction of the dry process, optimisation led to techniques which allowed drying, preheating and calcining to take place in a stationary installation rather than in the rotary kiln, as shown in Figure 1.10 above.

The rotary kiln consists of a steel tube with a length to diameter ratio of between 10:1 and 38:1. The tube is supported by two to seven (or more) support stations, has an inclination of 2.5 to 4.5 % and a drive rotates the kiln about its axis at 0.5 to 5.0 revolutions per minute. The combination of the tube's slope and rotation causes material to be transported slowly along it. In order to withstand the very high peak temperatures, the entire rotary kiln is lined with heat resistant bricks (refractories). All long and some short kilns are equipped with internals (chains, crosses, lifters) to improve heat transfer.

Transient build-ups of material can occur around the inner surface of the kiln depending on the process and raw materials, etc. These are known as rings and can occur at the feed end (gypsum rings), near the sintering zone (clinker rings) or the product exit end (ash rings). The latter two types can break away suddenly and cause a surge of hot, poor quality material to leave the kiln which may be reprocessed or have to be rejected as waste. The cyclones and grates of preheater kilns may also be subject to the build-up of material which can lead to blockages.

For these types of kilns it has to be noted that problems may be encountered in cases where an excessive input of circulating elements (chlorides, sulphur, alkalis) from the feed and/or fuel (see Sections 1.2.4.3.2 and 1.2.5.3.4) occurs.

### 1.2.5.1 Kiln firing

The fuel introduced via the main burner produces the main flame with flame temperatures of around 2000 °C. For process optimisation reasons, the flame has to be adjustable within certain limits. In a modern indirectly fired burner, the flame is shaped and adjusted by the primary air (10 – 15 % of total combustion air).

Potential feed points for supplying fuel to the kiln system are:

- via the main burner at the rotary kiln outlet end
- via a feed chute at the transition chamber at the rotary kiln inlet end (for lump fuel)
- via secondary burners to the riser duct
- via precalciner burners to the precalciner
- via a feed chute to the precalciner (for lump fuel)
- via a mid kiln valve in the case of long wet and dry kilns (for lump fuel)
- via the end of the Lepol grid.

Coal/petcoke firing plants are of both indirect- and direct-firing types. Direct-firing plants operate without fine-coal storage and fine-coal metering. The pulverised fuel is blown directly into the kiln with the mill sweeping air acting as the carrier and as (flame shaping) the primary air. Direct firing plants have a number of drawbacks. In particular, kiln system heat losses are around 200 – 250 MJ/tonne clinker (6 to 8 % higher on modern kiln systems). Thus, direct firing is seldom installed today.

Fuel oil is, at adequate viscosity and pressure, discharged via an atomiser nozzle into the kiln in order to form, e.g. the main flame. Flame shaping is mainly accomplished via multi-channel burners with the oil atomiser head in a central location.

Kiln burners for natural gas, too, are designed according to the multi-channel principle, the gas thereby replacing not only coal or fuel oil, but also primary air.

Multi-channel burners are also designed for the use of different types of waste fuels (see Section 1.2.4). An example is shown in Figure 1.11.



Source: [107, Belgium, 2006]

**Figure 1.11:** Example of a multi-channel burner

### 1.2.5.2 Long rotary kilns

Long rotary kilns can be fed with slurry, crushed filter cakes, nodules or dry meal and are thus suitable for all process types. The largest long kilns have a length to diameter ratio of 38:1 and can be more than 200 m long. These huge units produce around 3600 tonnes/day using the wet process (Belgium, US, Commonwealth of Independent States (CIS)). Long rotary kilns are designed for drying, preheating, calcining and sintering, so that only the feed system and cooler have to be added. The upper part of the long kilns is equipped with chain curtains and fixed installations to improve heat transfer.

Wet process kilns, used since 1895, are the oldest type of rotary kilns in use for producing cement clinker. Wet raw material preparation was initially used because homogenisation was easier with liquid material. Wet kiln feed typically contains 32 to 40 % water. This is necessary to maintain the liquid properties of the feed. This water must then be evaporated in the specially designed drying zone at the inlet section of the kiln where a significant portion of the heat from fuel combustion is used. This technique has high heat consumption with the resulting high quantities of combustion gas and water vapour emissions.

Long dry kilns were developed in the US based on batch type dry homogenising systems for raw material preparation. Because of the high fuel consumption, only a few have been installed in Europe.

### 1.2.5.3 Rotary kilns equipped with preheaters

Rotary kilns equipped with preheaters have a typical length to diameter ratio of between 10:1 and 17:1. There are two types of preheaters: grate preheaters and suspension preheaters.

#### 1.2.5.3.1 Grate preheater technique

Grate preheater technique, perhaps better known as the Lepol kiln, was invented in 1928. It represented the first approach to letting part of the clinkering process take place in a stationary installation outside the kiln. This allowed the rotary kiln to become shorter and so reduced the heat losses and increased energy efficiency.

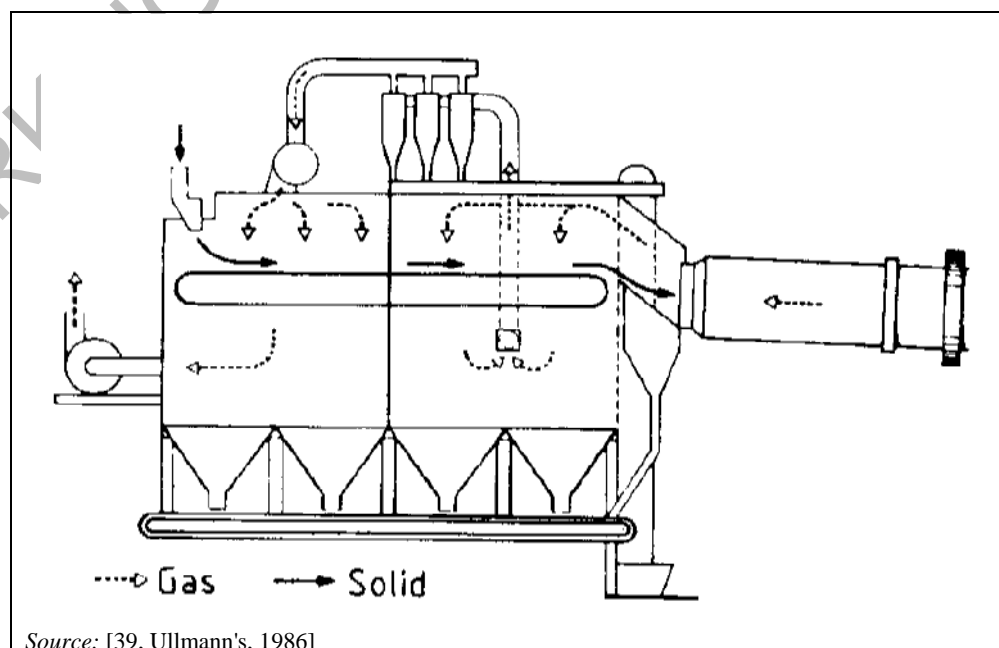


Figure 1.12: Grate preheater

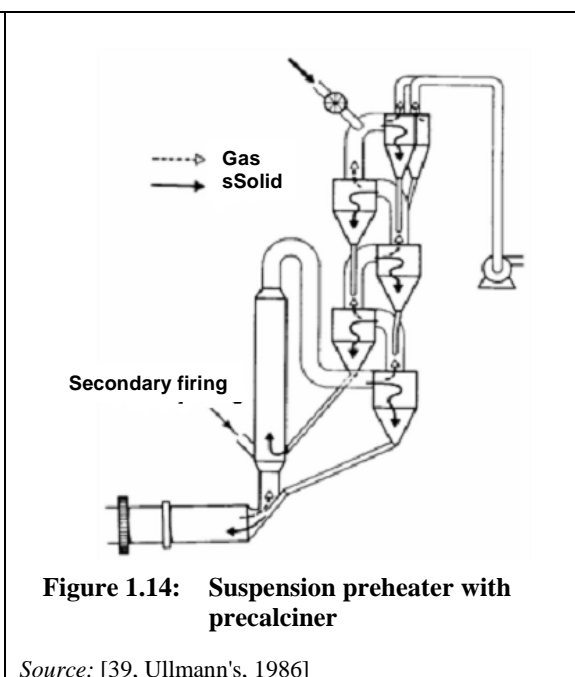
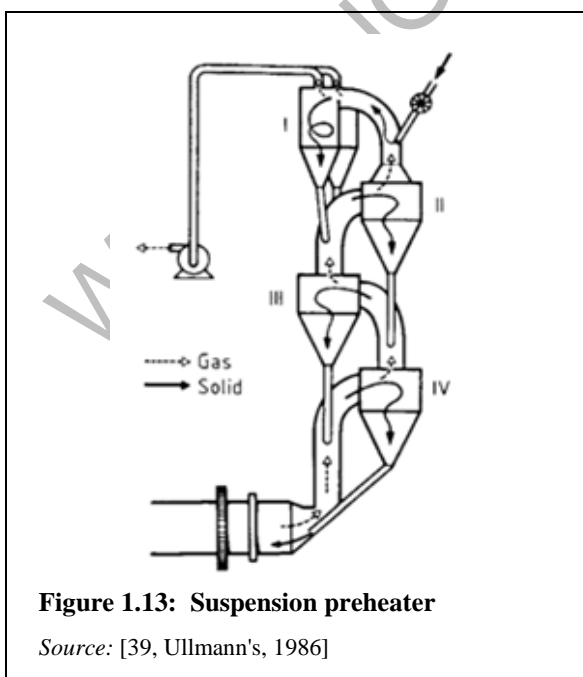
In the grate preheater (see Figure 1.12 ), nodules made from dry meal on a noduliser disc (semi dry process) or from wet slurry filter cakes in an extruder (semi-wet process) are fed onto a horizontal travelling grate which travels through a closed tunnel. The tunnel is divided into a hot gas chamber and a drying chamber by a partition with an opening for the grate. A fan draws the exhaust gas from the rotary kiln into the top of the preheater, through the nodules layer in the hot gas chamber, and then through the cyclones of the intermediate dust collector. In these cyclones large dust particles, which would otherwise cause wear to the fan, are removed. The next fan then draws the gas into the top of the drying chamber, through the moist layer of nodules, and finally pushes it out into the dust collector. In order to achieve optimum thermal efficiency, the semi-wet grate preheaters can be equipped with triple-pass gas systems, and cooler waste air is used for raw material drying. The maximum unit size to have been built is 3300 tonnes/day for a semi-wet kiln system.

The rotary kiln exhaust gas enters the preheater with a temperature of 1000 – 1100 °C. As it flows through the layer of material in the hot gas chamber, the exhaust gas cools down to 250/300 °C, and it leaves the drying chamber at 90 – 150 °C. The material to be burned reaches a temperature of about 150 °C in the drying chamber and 700 – 800 °C in the heating chamber.

**1.2.5.3.2 Suspension preheater technique**

The invention of the suspension preheater in the early 1930s was a significant development. Preheating and even partial calcination of the dry raw meal (dry/semi-wet processes) takes place by maintaining the meal in suspension with hot gas from the rotary kiln. The considerably larger contact surface allows almost complete heat exchange, at least theoretically.

Various suspension preheater systems are available. Examples are shown in Figure 1.13 and Figure 1.14. They usually have between four and six cyclone stages, which are arranged one above the other in a tower 50 – 120 m high. The uppermost stage may comprise two parallel cyclones for better dust separation. The exhaust gases from the rotary kiln flow through the cyclone stages from the bottom upwards. The dry powdery raw material mixture is added to the exhaust gas before the uppermost cyclone stage. It is separated from the gas in the cyclones and rejoins before the next cyclone stage. This procedure repeats itself at every stage until finally the material is discharged from the last stage into the rotary kiln. This alternate mixing, separation and remixing at a higher temperature is necessary for optimal heat transfer.



### 1.2.5.3.3 Shaft preheaters

A considerable number of shaft preheaters were built following the introduction of suspension preheater technique, given its theoretically superior heat exchange properties. However, the difficulty of ensuring an even distribution of meal to gas meant that actual performance was far worse than expected, and technique using shaft stages alone was eventually abandoned in favour of hybrid systems with cyclone stages or pure multistage cyclone preheaters. Some of those hybrids are still in operation; however, most of them have been converted to pure cyclone preheaters.

A shaft stage is considerably less sensitive to build-up problems than a cyclone stage, which can be an advantage for the bottom stage in cases where excessive quantities of circulating elements (chlorides, sulphur, and alkalis) are present. Hybrid preheaters with a bottom shaft stage are still available for new plants.

Typical capacities of shaft preheater kilns are up to 1500 tonnes/day, whereas hybrid systems can produce 3000 tonnes/day or more.

### 1.2.5.3.4 Four stage cyclone preheater

The four stage cyclone preheater kiln system (suspension preheater, see Figure 1.13) was standard technique in the 1970s when many plants were built in the 1000 to 3000 tonnes/day range. The exhaust gas, which has a temperature of around 300 – 400 °C at the top preheater cyclone stage is normally used for raw material drying.

When the meal enters the rotary kiln, calcination is already about 30 % completed because the kiln feed is already heated to a temperature of approx. 850 °C by using the exhaust gases. Severe problems have been encountered with four stage preheaters in the past in cases where inputs of circulating elements (chlorides, sulphur, alkalis) from the feed and/or fuel were excessive. Highly enriched cycles of these elements lead to build-ups in cyclones and duct walls, which frequently cause blockages and kiln stops lasting several days. A kiln gas bypass, i.e. extraction of part of the particulate laden gas stream leaving the kiln so that it bypasses the cyclone system, is frequently used as a solution to the problem. This bypass gas is cooled to condense the alkalis and is then passed through a dust collector before discharge. Whilst in some regions it is necessary for the control of clinker alkali levels to send the bypass dust and part of the kiln dust to landfill, in all other cases it is fed back into the production process.

Almost all four stage suspension preheaters operate with rotary kilns with three supports. This has been the standard design since around 1970. Kilns with diameters from 3.5 to 6 m have been built with length to diameter ratios in the range 13:1 to 16:1. Mechanically simpler than the long wet and dry kilns, it is probably the most widely used kiln type today.

### 1.2.5.4 Rotary kilns with preheater and precalciner

The precalcination technique has been available to the cement industry since about 1970. In this procedure, the heat input is divided between two points. Primary fuel combustion occurs in the kiln burning zone. Secondary burning takes place in a special combustion chamber between the rotary kiln and the preheater. In this chamber up to 65 % of the total fuel can be burned in a typical precalciner kiln. This is because of the significantly longer retention time of the hot meal, the kiln exhaust gases in the bottom area of the cyclone preheater and the use of additional tertiary air. The energy is basically used to calcine the raw meal, which is almost completely calcined when it enters the kiln. Calcination levels of well above 90 % can be achieved. Hot air for combustion in the calciner is ducted from the cooler. Material leaves the calciner at about 870 °C. Gas and solids temperature profiles in a cyclone preheater kiln system are shown in.

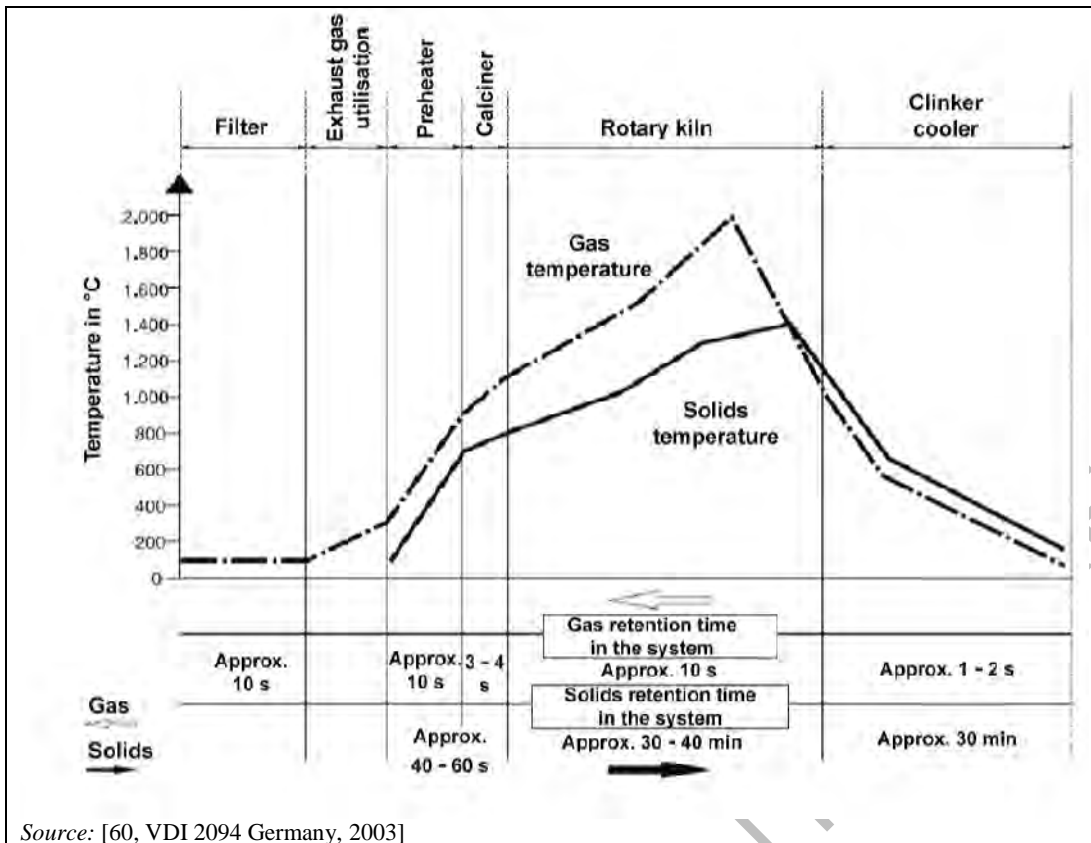
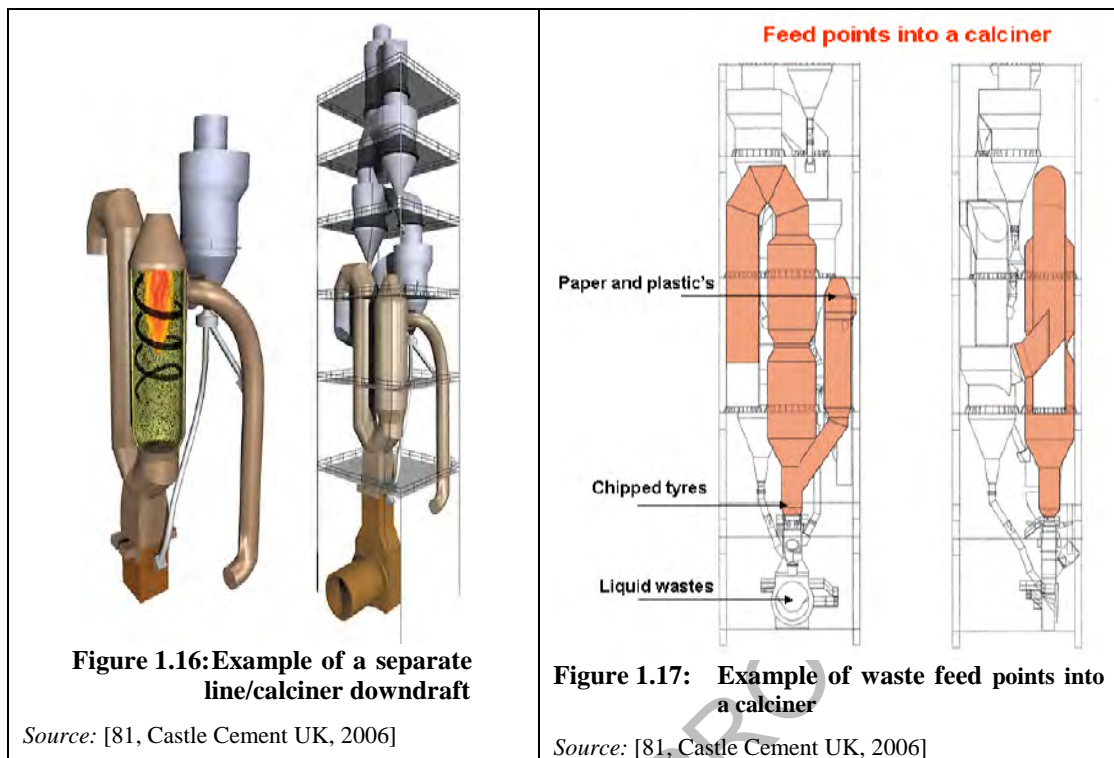


Figure 1.15: Gas and solids temperature profiles in a cyclone preheater kiln system

Figure 1.14 shows this procedure applied to a kiln with a suspension preheater. In principle, secondary burning can also be applied in a kiln with a grate preheater. For a given rotary kiln size precalcining increases the clinker capacity.

Kiln systems with up to five cyclone preheater stages and a precalciner are considered standard technique for new dry process plants. An example is shown in Figure 1.16. For the use of waste as fuels, the calciner technique is shown in Figure 1.17.





**Figure 1.16: Example of a separate line/calcliner downdraft**

Source: [81, Castle Cement UK, 2006]

**Figure 1.17: Example of waste feed points into a calciner**

Source: [81, Castle Cement UK, 2006]

The size of a new plant is primarily determined by predicted market developments, but also by the economy of scale. A typical unit capacity for new plants in Europe today is from 3000 to 5000 tonnes/day. Technically, larger units up to 15 000 tonnes/day are possible, and in 2007, several 10 000 tonnes/day kilns are in operation in Asian markets.

Earlier precalciner systems had only four preheater stages with accordingly higher exhaust gas temperatures and fuel consumption. Where natural raw material moisture is low, six stage preheaters can be the preferred choice, particularly in combination with fabric filter dedusting.

Where excessive input of circulating elements is present, a kiln gas bypass is required to maintain continuous kiln operation. However, due to the different gas flow characteristics, a bypass in a precalciner kiln is much more efficient than in a straight preheater kiln.

In spite of the fact that the meal enters the kiln 75 to 95 % calcined, most precalciner kilns are still equipped with a rotary kiln with a calcining zone, i.e. with an L/D ratio of 13:1 to 16:1 as in the case of the straight preheater kilns.

#### 1.2.5.4.1 Bypass systems

With raw materials as well as with fuels (including wastes) containing chlorine, sulphur and alkalis being fed to the kiln system, the internal circulation between the kiln and the preheater acts as an enrichment cycle. At higher concentrations, such a cycle causes deposit formation in the area of the kiln inlet, the calciner and the two bottom stages. As a uniform kiln operation with minimised disturbances is the basis for energy efficient clinker production, shutdowns resulting from coating formation should be avoided. Hence a high circulation of alkalis, chlorine and, to a lower extent, sulphur enforces the use of a gas bypass at the kiln inlet. By removing part of the process gas not only are chlorine, sulphur and alkalis discharged, but also other substances. The removal of hot raw material and hot gas leads as a consequence, to a higher specific energy consumption of about 6 – 12 MJ/tonne clinker per per cent of removed kiln inlet gas. Typical bypass rates are of up to 15 % for chlorine bypass and of up to 70 % for a sulphur bypass. The inherent scrubbing of SO<sub>x</sub> extracted along with the bypass gas is governed by:

- the amount of reactive lime
- the retention time at higher temperatures of  $>300\text{ }^{\circ}\text{C}$
- the retention time at lower temperatures of  $<200\text{ }^{\circ}\text{C}$  in the presence of water (vapour).

The bypass might create additional emissions depending on its configuration and additional thermal energy may be used [76, Germany, 2006], [86, EURITS, 2006], [89, ERFO, 2005], [103, CEMBUREAU, 2006].

### 1.2.5.5 Shaft kilns

A few shaft kilns are used for cement production in Europe. Kilns of this type consist of a refractory-lined, vertical cylinder 2 – 3 m in diameter and 8 – 10 m high. They are fed from the top with raw meal pellets and fine grained coal or coke. The material being burned travels through a short sintering zone in the upper, slightly enlarged part of the kiln. It is then cooled by the combustion air blown in from the bottom and leaves the lower end of the kiln on a discharge grate in the form of clinker.

Shaft kilns produce less than 300 tonnes of clinker a day. They are only economic for small plants, and for this reason their number has been diminishing.

### 1.2.5.6 Kiln exhaust gases

In all kiln systems, the exhaust gases are finally passed through an air pollution control device (electrostatic precipitator or fabric filter) for separation of the dust before going to the main stack.

In the dry processes, the exhaust gases can be at a relatively high temperature and may provide heat for the raw mill when it is running (compound operation). If the raw mill is not running (direct operation), the gases are normally cooled with water sprays in a conditioning tower before going to the dust collector, both to reduce their volume and to improve their precipitation characteristics.

#### 1.2.5.6.1 CO trips

Carbon monoxide can arise from any organic content in the raw materials and, occasionally, due to the incomplete combustion of fuel. The contribution from the raw materials, due to preheating, will be exhausted with the kiln gases.

Control of CO levels is critical in cement (and lime) kilns when ESPs are used for particulate abatement, to ensure concentrations are kept well below the lower explosive limit. If the level of CO in the ESP rises above a certain level as shown in Table 1.38 (see Section 1.4.5.3), then the electrical system is tripped (switched off) to eliminate the risk of explosion. This leads to unabated particulate releases from the kiln. CO trips can be caused by unsteady state operation of the combustion system. This sometimes occurs when feeding solid fuels, so solid fuel feeding systems must be designed to prevent surges of fuel into the burner. The moisture content of solid fuels is a particularly critical factor in this respect and must be carefully controlled to prevent hold ups or blockages in the fuel preparation and feeding systems.

A guideline concerning the control of CO trips can be found in Section 6.2.6.

### 1.2.5.7 Clinker coolers

The clinker cooler is an integral part of the kiln system and has a decisive influence on performance and economy of the pyroprocessing plant. The cooler has two tasks: to recover as much heat as possible from the hot (1450 °C) clinker so as to return it to the process; and to reduce the clinker temperature to a level suitable for the equipment downstream.

Heat is recovered by preheating the air used for combustion in the main and secondary firing as close to the thermodynamic limit as possible. However, this is hindered by high temperatures, the extreme abrasiveness of the clinker and its wide granulometric range. Rapid cooling fixes the mineralogical composition of the clinker to improve the grindability and optimise cement reactivity.

Typical problems with clinker coolers are thermal expansion, wear, incorrect airflows and poor availability, which work against the above requirements. There are two main types of coolers: rotary and grate.

For white cement production, other types of coolers are used, tailor made to the specificities of the plant in order to retain the reducing conditions during clinker cooling. An oxygen-free atmosphere in the first stage of whitening and the rapid cooling by water spray are used for improvement of the clinker quality. Rapid cooling of white clinker with water proceeds a significant improvement of whiteness. The contamination of white clinker with chromophoric elements and the strong oxidation during the cooling phase has to be avoided [119, Sobolev, 2001], [120, Spain, 2007], [138, Italy, 2007].

#### 1.2.5.7.1 Rotary coolers

##### 1.2.5.7.1.1 Tube coolers

The tube cooler uses the same principle as the rotary kiln, but for reversed heat exchange. Arranged at the outlet of the kiln, often in reverse configuration, i.e. underneath the kiln, a second rotary tube with its own drive is installed. After kiln discharge, the clinker passes a transition hood before it enters the cooler, which is equipped with lifters to disperse the product into the airflow. Cooling of the airflow is determined by the air required for fuel combustion. Apart from the speed, only the internals can influence the performance of the cooler. Optimisation of lifters must consider heat exchange (dispersion pattern) versus dust cycle back to the kiln.

##### 1.2.5.7.1.2 Planetary (or satellite) coolers

The planetary or satellite cooler is a special type of rotary cooler. Several cooler tubes, typically 9 to 11, are attached to the rotary kiln at the discharge end as shown in Figure 1.18. The hot clinker enters through openings in the kiln shell arranged in a circle at each point where a cooler tube is attached. The quantity of cooling air is determined by the air required for fuel combustion and enters each tube from the discharge end, allowing countercurrent heat exchange. As for the tube cooler, internals for lifting and dispersing the clinker are essential. There are no variable operating parameters. High wear and thermal shock, in conjunction with dust cycles, mean high clinker exit temperatures and sub-optimum heat recovery are not unusual. The clinker exit temperature can only be further reduced by water injection into the cooler tubes or onto the shell.

Because it is practically impossible to extract tertiary air, the planetary cooler is not suitable for precalcination. However, secondary firing with up to 25 % fuel in the kiln riser area is possible.



Source: [45, Schorcht, 2006] [90, Hungary, 2006]

**Figure 1.18:** Example of a planetary cooler

### 1.2.5.7.2 Grate coolers

Cooling in grate coolers is achieved by passing a current of air upwards through a layer of clinker (clinker bed) lying on an air-permeable grate. Two ways of transporting the clinker are applied: travelling grate and reciprocating grate (steps with pushing edges).

Since the hot air from the aftercooling zone is not used for combustion, it is available for drying purposes, e.g. raw materials, cement additives or coal. If not used for drying, this cooler waste air must be properly dedusted.

#### 1.2.5.7.2.1 Travelling grate coolers

In this type of cooler, clinker is transported by a travelling grate. This grate has the same design features as the preheater grate (Lepol). Cooling air is blown by fans into compartments underneath the grate. Advantages of this design are an undisturbed clinker layer (no steps) and the possibilities of exchanging plates without a kiln stop. Due to its mechanical complexity and poor recovery resulting from limited bed thickness (caused by the difficulty of achieving an effective seal between the grate and walls), this design ceased to be used in new installations in around 1980.

#### 1.2.5.7.2.2 Reciprocating grate coolers

Clinker transport in the reciprocating grate cooler is affected by stepwise pushing of the clinker bed by the front edges of alternate rows of plates. Relative movement of front edges is generated by hydraulic or mechanical (crankshaft) drives connected to every second row. Only the clinker travels from the feed end to the discharge end, but not the grate.

The grate plates are made from heat resistant cast steel and are typically 300 mm wide and have holes for the air to pass through them.

Cooling air is insufflated from fans at 300 – 1000 mmWG via compartments located underneath the grate. These compartments are partitioned from one another in order to maintain the pressure profile. Two cooling zones can be distinguished:

- the recuperation zone, from which the hot cooling air is used for combustion of the main burner fuel (secondary air) and the precalciner fuel (tertiary air)

- the aftercooling zone, where additional cooling air cools the clinker to lower temperatures.

Key features of modern cooler technique are (depending on supplier):

- modern plates with built-in, variable or permanent, pressure drop, permeable to air but not to clinker
- forced plate aeration via ducts and beams
- individually adjustable aeration zones
- fixed inlet
- fewer and wider grates
- roller crusher
- heat shields.

The largest units in operation have an active surface of about 280 m<sup>2</sup> and a cooling capacity of 10000 tonnes clinker per day. Typical operational challenges with these coolers are segregation and uneven clinker distribution leading to an air-clinker imbalance, fluidisation of fine clinker (red river) and also build-ups (snowmen) and less than ideal lifetime of the plates.

#### 1.2.5.7.2.3 Third generation of grate coolers

Introduction and development of modern technique reciprocating grate coolers started around 1983. The design aimed to eliminate the difficulties with conventional coolers thus coming a step closer to optimum heat exchange and also more compact coolers using less cooling air and smaller dedusting systems.

In the 2000s, a new generation representing a completely new concept of cooling clinker emerged in the cement industry. The basic idea was to develop a cooler in which the conveying of clinker and air distribution systems are separated and optimised. Compared with the reciprocating grate coolers, sealing air is eliminated and the distribution of air is optimised for all modes of operation.

Key features of these types of coolers are (depending on supplier):

- one inclined or horizontal fixed grate
- clinker conveying by cross bars, tracks, walking floors or similar devices, separate from air distribution
- clinker stays in place and does not fall through to the under grate compartment
- elimination of sealing air and automatic control of air distribution
- clinker transport efficiency is improved with a better control of difficulties related to fluidisation of fine clinker (red river).

These types of coolers are suitable to be in operation with the largest clinker capacities of cement kilns.

#### 1.2.5.7.3 Vertical coolers

A dust free aftercooler called a gravity cooler or a G-cooler was developed to be installed after a planetary cooler or short grate recuperator/cooler. The cooling air never comes into contact with the clinker as heat exchange is affected by the clinker descending over transverse steel tubes in the clinker bed, which in turn are cooled by air blown through them.

### 1.2.5.8 Cogeneration

Generation of electrical power and using excess heat from the cement production process can be applied in cement plants.

Normally the majority of heat emitted from a cement clinker kiln is used for the drying and dry grinding processes as follows:

- raw material drying and grinding/milling
- slag drying
- sand drying
- fuel drying and grinding.

Multistage suspended cyclone preheater plants – with or without a precalciner – are designed to suit the nature of the available raw materials. When the raw materials are very wet, the off-gas of the grate clinker cooler is also used for material processing.

The lime-based raw materials need, depending on geology and seasonal rainfall, varying levels of heat for driving off the moisture. At times though, some heat is in excess for the above-mentioned process needs. It has to be noted that the excess heat availability and subsequently the heat recovery technique has to take this variability into account.

Besides district heating, excess heat can also be used for electrical power generation. Normally, these processes are operated with water which needs to operate economically at relatively high steam temperature/pressure if electrical power is to be generated.

For the first time in a German cement kiln, the Organic Rankine Cycle (ORC) process for the cogeneration of power from low temperature waste heat has been applied. This process is essentially based on the use of pentane as the motive medium which evaporates to steam at significantly lower temperatures than water. The particular advantages are the simple operation, the compact structure and the relatively high levels of efficiency which can be achieved with heat sources below 275 °C. Therefore, generation of electrical power by using excess heat from the cement production process can be regarded as a technically feasible alternative to power generating plants using steam if certain preconditions are applied.

The results available from the one German cement plant indicate that 1.1 MW electrical power can be generated with the given mode of operation. This was achieved by a clinker cooler with a waste heat output of exhaust air of 14 MW and an exhaust gas temperature of 300 °C [76, Germany, 2006], [78, E. Baatz + G. Heidt, 2000], [79, Germany, 2001], [133, CEMBUREAU/Federhen, 2007].

Example plants and more information concerning the recovery of excess heat from clinker coolers or kiln off-gases for district heating, the cogeneration of electric power via the conventional steam cycle process, as well as the ORC process in operation can be found in Section 1.4.2.4 and in Section 6.2.3.

## 1.2.6 Cement grinding and storage

### 1.2.6.1 Clinker storage

Clinker and other cement components are stored in silos or in closed sheds. Larger stocks can be stored in the open if the necessary precautions against dust formation are taken.

The most common clinker storage systems are:

- longitudinal stores with gravity discharge (limited live stock)
- circular stores with gravity discharge (limited live stock)
- clinker storage silos (high live stock; problems with ground vibrations can occur during clinker withdrawal from the silo at certain silo levels)
- clinker storage domes (limited live stock).

### 1.2.6.2 Cement grinding

Portland cement is produced by intergrinding cement clinker and sulphates such as gypsum and anhydrite. In blended cements (composite cements) there are other constituents, such as granulated blast furnace slag, fly ash, natural or artificial pozzolanas, limestone, or inert fillers. These will be interground with the clinker or may need to be dried and ground separately. (Grinding plants may be at separate locations from clinker production plants.)

The kind of cement grinding process and the plant concept chosen at a specific site depend on the cement type to be produced. Of special importance are the grindability, the humidity and the abrasive behaviour of the compounds of the cement type produced.

Most mills work in a closed circuit, that is, they can separate cement with the required fineness from the material being ground and return coarse material to the mill.

For white cement production, final grinding is one of the most essential steps along with the selection of appropriate types of gypsum with high purity. For increasing the fineness and for decreasing the grinding time, an appropriate grinding aid (up to 1 %) is used, which results in an increase of whiteness of between 5 – 7 %. Furthermore, finely ground microfillers like white marble or quartz glass, pure silica gel, mica or talc, kaolin (or metakaolin) or powders with traces of  $\text{TiO}_2$  could be used in relatively small quantities [119, Sobolev, 2001].

#### 1.2.6.2.1 Metering and proportioning of the mill feed

The accuracy and reliability of metering and proportioning of the mill feed components by weight is of great importance for maintaining a high energy efficiency of a grinding system. The predominant metering and proportioning equipment for the material feed to mills is the belt weigh feeder.

#### 1.2.6.2.2 Grinding of cement

Due to the variety of cement types required by the market, the latest grinding systems equipped with a dynamic air separator predominate.

Commonly used finish grinding systems are:

- tube mills, closed circuit (mineral addition is rather limited, if not dry or pre-dried)
- vertical roller mills (best suited for high mineral additions due to its drying capacity, best suited for separate grinding of mineral addition)
- roller presses (mineral addition is rather limited, if not dry or pre-dried).

Other finish grinding systems used are:

- tube mill, end discharge in open circuit
- tube mill, end discharge in closed circuit with mechanical air separator or cyclone air separator of older generations
- horizontal roller mills.

*Ball mills* (type of a *tube mill*) are available in tube diameters of up to 6 m and tube lengths of up to 20 m. Steel balls of different sizes are used depending on the expected grinding fineness. This type of mill is relatively easy to operate under stable operating conditions and has a high operating reliability and availability. To a limited extent also mineral additions with certain moisture contents can be dried by passing hot gases to the mill and using the heat from the grinding process. However, compared with other mill types, ball mills have a higher specific energy consumption and rank last in energy efficiency.

The working principle of *vertical roller mills* is based on the action of two to four grinding rollers supported on hinged arms and riding on a horizontal grinding table or grinding bowl. It is suited especially for simultaneous grinding and drying of cement raw materials or slag since vertical roller mills can handle relatively high moisture contents in the mill feeds. The transition time for materials through the mill is short enough to prevent prehydration of the cement clinker, e.g. in the case of slag cement grinding.

The *high pressure twin roller mill* still needs a comparatively high degree of maintenance. High pressure twin roller mills are often used in conjunction with ball mills.

A more recent development in cement grinding is the *horizontal roller mill*. This consists of a short horizontal shell supported on hydrodynamic or hydrostatic bearings. The shell is rotated via a girth gear. Inside the shell is a horizontal roller which is free to rotate and can be pressed hydraulically onto the shell. The material to be ground is fed into one or both ends of the shell, and passes between the roller and the shell several times. The crushed material leaving the mill is transported to a separator, with the oversize fraction being returned to the mill.

A comparison of key characteristics from grinding technique examples are shown in Table 1.19 in Section 1.3.3.2.

### 1.2.6.2.3 Grinding of mineral additions

Mineral additions are usually ground together with the clinker and gypsum. The decision to grind them separately basically depends upon the following factors:

- the percentage of mineral additives in the final product and in cement production as a whole
- whether a spare mill system is available
- whether there is a considerable difference in the grindability of the clinker and mineral additives
- the moisture content of the mineral additives.

If pre-drying of the mineral additives is required, dryer systems can be employed using either kiln exhaust gases and/or cooler exhaust air or an independent hot gas source.

#### *Intergrinding systems*

Any of the grinding systems mentioned for the dry/semi-dry grinding of raw materials can be used for intergrinding mineral additives with clinker and gypsum. However, most systems place limits on the moisture content of the feed mixture – 2 % maximum or 4 % if a hot gas source is used. For higher moisture contents, the systems require pre-drying of the mineral additives in a dryer. An exception is the vertical roller system, which is capable of handling moisture contents of up to 20 %, but still requires a hot gas source.



### *Separate grinding*

For separate grinding of mineral additives, the systems for the dry/semi-dry grinding of raw materials can be used. However, the same applies for the systems with regard to the moisture content of the additive mixtures and pre-drying may be required.

#### **1.2.6.2.4 Separation by particle size distribution**

The particle size distribution of the product leaving the cement grinding system is of great importance for the cement quality. The specification of these parameters is achieved by adjusting the separator. The latest separators of the rotor cage type have several advantages over previous designs, such as:

- lower specific energy consumption by the system (less overgrinding)
- increase of system throughput (efficiency)
- possibility of product cooling
- higher flexibility for adjustments in product fineness
- better control of particle size distribution, better product uniformity.

#### **1.2.6.2.5 Reduction of chromates – chromium (VI)**

Since cement is produced from natural raw materials, its chromium content may vary considerably, depending on the circumstances, but it is unavoidable. The main sources of chromium in Portland cement are the natural raw materials like limestone, sand and in particular, clay. Minor sources include fuels (conventional (fossil) and waste). Consequently, as a result of natural variations in the chemical composition of the earth's crust, the chromium content may vary considerably. A part of the chromium will be present in a water soluble form, the so-called hexavalent chromium (chromium (VI)).

In 2003, an epidemiological assessment from the National Institute of Occupational Health regarding the occurrence of allergic dermatitis in workers in the construction industry related to the content of chromium (VI) in cement was made. This assessment said that 'the main sources of chromium in finished cement are the raw materials, the refractory bricks in the kiln and the chromium grinding media. The relative contribution from these sources may vary, depending on the chromium content of the raw materials and on the manufacturing conditions. In a study of clinker grinding with chrome alloy balls of 17 – 28 % chromium, the hexavalent chromium of the cement increased to over twice that present in the original clinker.'

When dissolved in water, chromium (VI) may penetrate unprotected skin. This water soluble chromium (VI) may cause allergic dermatitis, also called 'cement eczema'. 'Cement eczema' also covers another type of dermatitis: irritant dermatitis, caused by the alkaline nature of cement mixed with water.

The EU Directive on chromates (2003/53/EC) restricted the marketing and use of cement with more than 0.0002 % (2 ppm) soluble chromium (VI). In general for the cement industry, it is not possible to reduce the chromate content in cement at the input phase, as the main sources are the raw materials. Therefore in 2007, the only way to reduce the water soluble chromium (VI) in cement is to add a reducing agent to the finished products. The main reducing agents used in Europe are ferrous sulphate and tin sulphate [86, EURITS, 2006], [103, CEMBUREAU, 2006], [111, European Union, 2003].

### 1.2.6.3 Storage of cement

Both pneumatic and mechanical conveying systems can be used for transporting cement to storage silos. Mechanical systems normally have a higher investment cost but a much lower operating cost than pneumatic transport. A combination of air-slide or screw/chain conveyors with a chain bucket elevator is the most commonly used conveying system.

Different cements are stored separately in silos. Usually various silos are required for the storage of cements. However, new silo designs allow the storage of more than one type of cement in the same silo. The silo configurations used for cement storage are:

- single-cell silos with a discharge hopper
- single-cell silos with a central cone
- multi-cell silos
- dome silos with a central cone.

Compressed air is used to initiate and maintain the cement discharge process from these silos via aeration pads located at the bottom of the silo.

### 1.2.7 Packaging and dispatch

Cement is transferred from the silos either directly into bulk road, rail or ship tankers, or to a bag packaging station.

WORKING DRAFT IN PROGRESS

### 1.3 Current consumption and emission levels

It has to be noted that, if not otherwise mentioned in this document, for this section concerning the cement industry, the standard conditions for measurements of volume flows and concentrations of flue-gases are related to the following definitions which are also stated in the Glossary:

m <sup>3</sup> /h	volume flow: if not otherwise mentioned in this document, the volume flows refer to 10 vol-% oxygen and standard state
mg/Nm <sup>3</sup>	concentration: if not otherwise mentioned in this document, the concentrations of gaseous substances or mixtures of substances refer to dry flue-gas at 10 vol-% oxygen and standard state
standard state	refers to a temperature of 273 K, a pressure of 1013 hPa and dry gas

In addition, it has to be noted that the emissions ranges refer to a reference oxygen level of 10 % although the actual oxygen level within the firing process is much lower than 10 %, e.g. 3 %. The calculation formula for calculating the emissions concentration is shown below:

$$E_R = \frac{21 - O_R}{21 - O_M} * E_M$$

$E_R$  (mg/Nm<sup>3</sup>): emissions concentration related to the reference oxygen level  $O_R$   
 $O_R$  (vol %): reference oxygen level  
 $E_M$  (mg/Nm<sup>3</sup>): emissions concentration related to the measured oxygen level  $O_M$   
 $O_M$  (vol %): measured oxygen level

Additional useful information on monitoring can be found in the Reference Document on the General Principles of Monitoring (MON) [151, European Commission, 2003].

The main environmental issues associated with cement production are emissions to air and energy use. Waste water discharge is usually limited to surface run off and cooling water only and causes no substantial contribution to water pollution. The storage and handling of fuels is a potential source of contamination of soil and groundwater.

The purpose of a mass balance is to evaluate the mass components entering and exiting the system taking into account the law of mass conservation. The evaluation of all mass balance items requires a previous knowledge of process data like raw materials and fuel compositions, gas streams, atmospheric data, etc. In a cement plant, with a system consisting of raw mill, preheater, kiln and cooler, the following input and output flows are important:

- input flows:
  - raw materials (conventional and/or waste)
  - energy (fuels (fossil and/or waste and/or biomass), electrical energy)
  - water (including fuel moisture, raw material moisture, air moisture and water injection in raw mill)
  - air (primary air, transport air, cooling air and leak air)
  - auxiliary agents (mineral additions, packaging material)
- output flows:
  - clinker
  - process losses/waste (filter dusts)
  - emissions to air (e.g. dust, NO<sub>x</sub>, SO<sub>x</sub>; see also mass balance Figure 1.19)
  - emissions to water (in rare cases).

The input data are the following:

- dry process; five stage preheater, precalciner, grate cooler, vertical raw mill
- fuel: 100 % petroleum coke
- heat consumption: 3300 kJ/kg clinker
- petcoke (net) calorific value (NCV): 33 500 kJ/kg fuel
- kiln feed: 1.66 kg/kg clinker; standard kiln feed chemical composition
- raw material factor: 1.52 kg/kg clinker and 5 % moisture
- air moisture: 1 %
- raw mill:
  - leak air: 30 %
  - water injection: 0.5 % kiln feed
- clinker/cement factor: 0.8.

A mass balance for the production of 1 kg of cement using the dry process with petcoke as the fuel is shown in Figure 1.19.

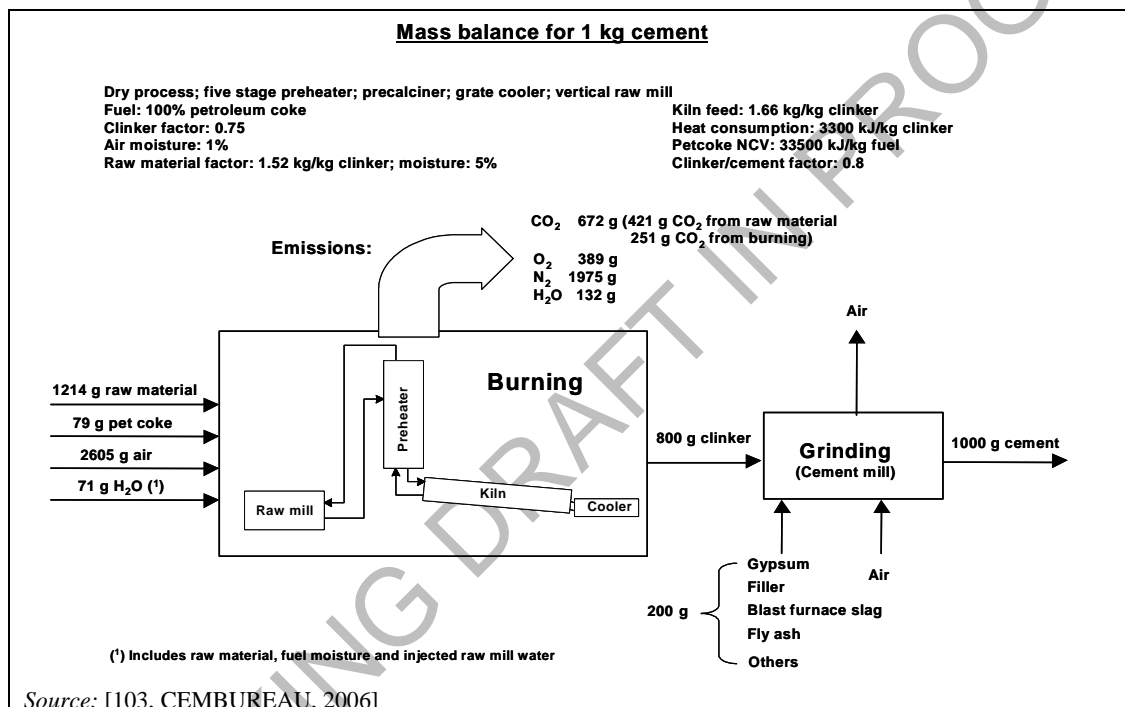


Figure 1.19: Mass balance for the production of 1 kg cement using the dry process

### 1.3.1 Consumption of water

Water is used at a number of stages during the production process. In only some cases, water is used for the preparation of raw material, in clinker burning and cooling processes, such as the cooling of gases, as well as in the technological process for slurry production. In the semi-dry process, water is used for pelletising the dry raw meal. Plants using the wet process use more water (per tonne of cement produced) in preparing the kiln feed slurry and a typical water consumption of 100 – 600 litres water per tonne clinker is reported. Furthermore, for special applications, water is used for clinker cooling and a water usage of around 5 m<sup>3</sup>/hour has been reported. In most cases, the water consumed is not potable water [45, Schorcht, 2006], [75, Estonia, 2006], [81, Castle Cement UK, 2006], [103, CEMBUREAU, 2006], [120, Spain, 2007].

### 1.3.2 Consumption of raw materials

Cement manufacture is a high volume process. The figures in Table 1.15 indicate typical average consumptions of raw materials for the production of cement in the European Union. The figures in the final column are for a plant with a clinker production of 3000 tonnes/day or 1 million tonnes/year, corresponding to 1.23 million tonnes cement per year based on the average clinker content in European cement.

Materials (dry basis)	Per tonne clinker	Per tonne cement	Per year per Mt clinker
Limestone, clay, shale, marl, other	1.57 t	1.27 t	1568 000 t
Gypsum, anhydrite	-	0.05 t	61 000 t
Mineral additions	-	0.14 t	172 000 t

*Source:* [9, CEMBUREAU, 1997 November]

**Table 1.15: Consumption of raw materials in cement production**

#### 1.3.2.1 Consumption of wastes as raw materials

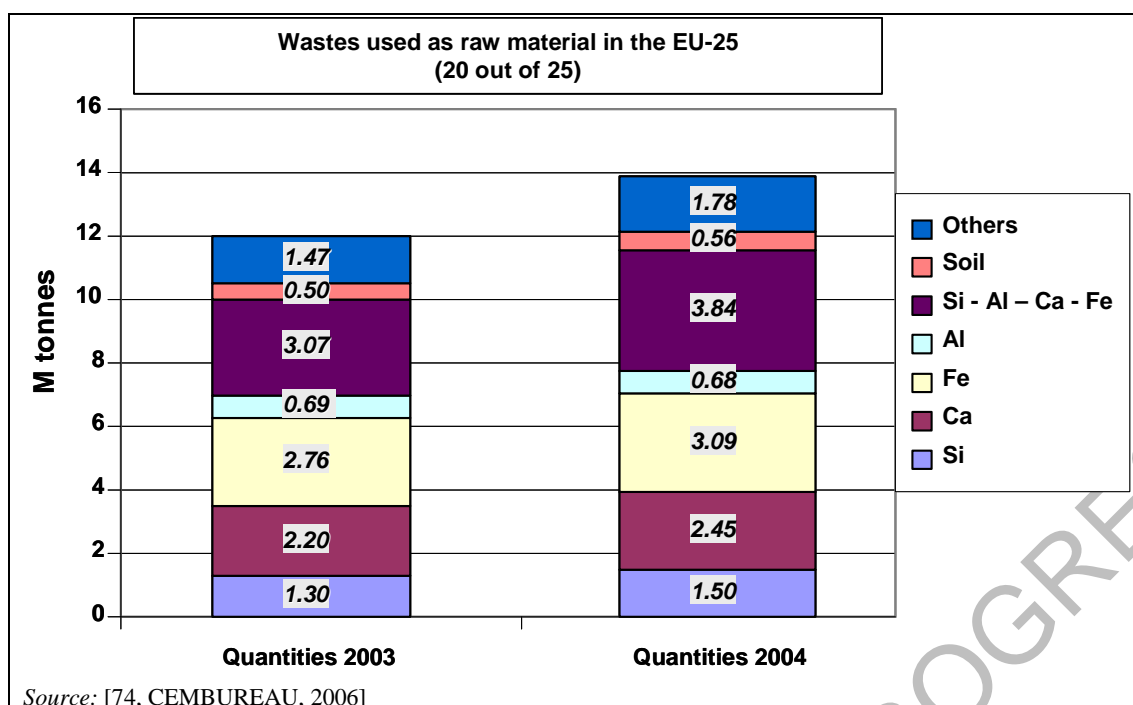
The use of wastes as raw materials in the clinker burning process can replace a relatively large amount of raw materials (see also Section 1.2.4). The quantities of wastes used as raw materials in clinker production have more than doubled since 2001. In 2004, waste raw materials used in clinker production allowed the cement industry to make a direct saving of almost 14 million tonnes of conventional raw materials, which is equivalent to about 6.5 % of the natural raw materials needed.

However, these waste raw materials have to show and meet characteristics, chemical elements and components which are necessary for the clinker burning process. These waste materials may have an impact on the emissions behaviour of the process and an effect on the emissions. Impacts on emissions are discussed in Section 1.3.4.13. Table 1.16 lists the consumption of wastes used as raw materials characterised by chemical elements used by the EU-27 in 2003 and 2004 for clinker production. Figure 1.20 shows the share used by 20 countries of the EU-27.

Wastes used as raw materials			
Desired (primary) chemical elements	Examples of waste streams	Quantities 2003 (million tonnes)	Quantities 2004 (million tonnes)
Si	Spent foundry sand	1.52	1.50
Ca	Industrial lime Lime slurries Carbide sludge Sludge from drinking water treatment	2.20	2.44
Fe	Pyrite cinder Synthetic hematite Red mud	3.29	3.37
Al		0.71	0.69
Si-Al-Ca-Fe	Fly ash Slags Crusher fines	3.37	3.78
Soil		0.45	0.50
S group	Industry by-product gypsum		
F group	CaF <sub>2</sub> Filter sludge		
Others		1.56	1.71
Total		13.10	13.89

*Source:* [74, CEMBUREAU, 2006], [103, CEMBUREAU, 2006]

**Table 1.16: Wastes used as raw materials characterised by chemical elements used in cement manufacturing in the EU-27 in 2003 and 2004**



**Figure 1.20:** Wastes used as raw materials in 20 countries of the EU-27

For cement grinding, the consumption of wastes as raw materials has increased. As an example, it was reported that the use of oil shale fly ash doubled up to 100 kt/yr from 2000 to 2005 [75, Estonia, 2006].

### 1.3.3 Use of energy

The cement industry is a highly energy consuming industry, depending on the process used. The use of fuels and electricity are the two main types of energy used in cement manufacture. Energy efficiency (both thermal and electrical) has been a priority for many decades for the European cement industry as part of the overall business decisions which are driven by economic and technological needs [103, CEMBUREAU, 2006].

#### 1.3.3.1 Thermal energy demand

The theoretical thermal (fuel) energy demand for cement clinker production is determined by the energy required for the chemical/mineralogical reactions of the clinker burning process (1700 to 1800 MJ/tonne clinker) and the thermal energy required for raw material drying and preheating, mainly depending on the moisture content of the raw material as given by the examples shown in Table 1.17. In modern preheater kilns, the number of cyclones can be limited by the chemical composition of the raw material.

Characteristics	Unit	Raw material moisture (% w/w)			
		3	6	9	12
Number of cyclone stages	-	6	5	4	3
Enthalpy required for drying	MJ/t <sub>clinker</sub>	150	290	440	599

Source: [137, Klein/Hoenig, 2006]

**Table 1.17:** Examples of thermal energy required for drying the raw meal

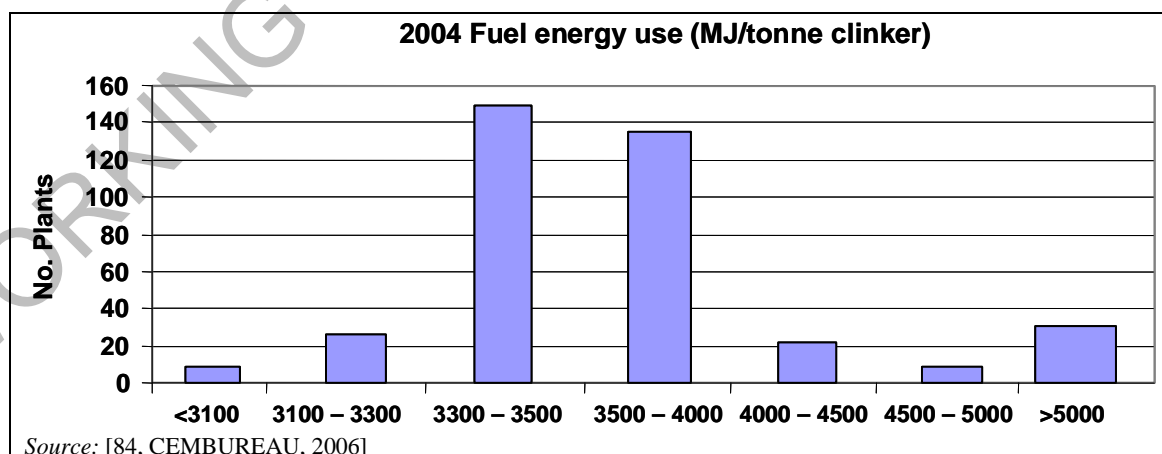
The actual thermal (fuels) demand for different kiln systems and kiln sizes is within the ranges shown in Table 1.18, as well as the fuel energy use for special cement production. Practical experience shows that the energy consumption of plants using the dry process, with multistage cyclone preheaters and precalcining kilns starts at about 3000 and can reach more than 3800 MJ/tonne clinker (as an annual average). The variations in this range are due to shutdowns and start-ups of the systems and e.g. because of different raw material properties. Table 1.17 gives an estimation of the influence of the raw material moisture on the thermal energy demand for cyclone preheater kilns

Specific thermal energy demand (MJ/tonne clinker)	Process
3000 – <4000	For the dry process, multistage (three to six stages), cyclone preheaters and precalcining kilns
3100 – 4200	For the dry process rotary kilns equipped with cyclone preheaters
3300 – 5400	For the semi-dry/semi-wet processes (Lepol kiln)
up to 5000	For the dry process long kilns
5000 – 6400	For the wet process long kilns
3100 – 6500 and higher	For shaft kilns and for the production of special cements

*Source:* [75, Estonia, 2006] [76, Germany, 2006] [84, CEMBUREAU, 2006], [92, Austria, 2006], [120, Spain, 2007], [168, TWG CLM, 2007]

**Table 1.18: Fuel energy use in cement manufacturing in the EU-27**

Figure 1.21 shows the fuel energy use in the cement industry in the EU-27 in 2004 without a distinction being made between the different processes (dry, semi-dry/-wet or wet) and fuels (fossil and/or waste) used. Approximately 30 cement plants in the EU-27 are high consumers of fuel energy with more than 5000 MJ/tonne clinker, e.g. for the production of special cement such as white cement (see also Table 1.18). Energy consumption for white cement production is affected by a higher temperature which is needed for producing this type of white clinker in comparison to the production of other types of clinker (grey clinker) [75, Estonia, 2006], [84, CEMBUREAU, 2006], [120, Spain, 2007].



**Figure 1.21: Fuel energy use in the EU-25 cement industry in 2004**

Different parameters can influence the specific energy consumption, such as [92, Austria, 2006]:

- size and plant design
  - three to six cyclone stages
  - calciner
  - tertiary air
  - compound operation of the mill
  - length to diameter ratio of the kiln
  - type of clinker cooler
- throughput of the kiln
- moisture content of raw materials and fuels
- raw material properties, such as burnability
- specific calorific value of the fuels
- type of clinker
- homogenising and precise metering of kiln feed material and fuels
- optimisation of process control including flame cooling
- bypass rate.

When changing the fuel mix used, the specific energy consumption per tonne of clinker can vary due to various reasons, depending on the type of fuels (conventional or waste fuel), their parameters, e.g. moisture content, reactivity or coarseness, and the calorific value of the fuels used.

One of the main impacts on energy consumption is due to the preparation of fossil fuels like coal or lignite which are, in many cases, partly or completely dried outside of the kiln system, even outside of the cement plant. Lignite, for example, can be extracted with a moisture content of above 50 % and needs to be dried before delivery to the cement plant. When replacing dried fuels by fuels having a higher moisture content, an increase of the energy consumption per tonne of clinker in the kiln system is possible, but can be globally compensated by the energy saved from the avoided drying and transport of fossil fuels.

On the issue of fuel moisture, the efficiency of the process varies depending on the type of fuel drying used, such as fuel drying by using waste heat from the process or effectively drying the fuel inside of the kiln, which will require more energy for removing the moisture content. Some fuels also partly contain wet minerals used as the raw material. These minerals are dried into the kiln system, and can also increase the specific energy consumption per tonne of clinker.

Furthermore, a high substitution rate of waste fuels in combination with different parameters, e.g. lower calorific values of these waste fuels, high moisture content, design of the plant, can relate to a higher energy use as shown in examples from Austria and the UK (see Section 1.3.3.3). In cases where plants are suitable and designed especially for the co-incineration of certain types of waste fuels, thermal energy consumption can still be in the range of between 3120 – 3400 MJ/t clinker. Austrian cement plants reported results from a 48 hours test trial with a considerable amount of low calorific value that included rather humid plastics achieving 3400 MJ/t clinker. Furthermore, in the UK, energy consumption of 3473 kJ/kg has been reported for a five stage precalciner kiln. However, potentials for improvements have been stated [81, Castle Cement UK, 2006], [92, Austria, 2006], [163, Castle Cement UK, 2006], [168, TWG CLM, 2007], [171, A TEC, 2007].

### 1.3.3.2 Electrical energy demand

The main users of electricity are the mills (finish grinding and raw grinding) and the exhaust fans (kiln/raw mill and cement mill) which together account for more than 80 % of electrical energy usage. On average, energy costs – in the form of fuel and electricity – represent 40 % of the total production cost involved in producing a tonne of cement. Electrical energy represents up to 20 % of this overall energy requirement. The electricity demand ranges from 90 to 150 kWh/tonne cement. Between 2004 and 2006, electricity costs increased from 14 % of total



cement production cost to 25 %. The wet process is more energy intensive than the semi-wet or the dry process [20, Rother, 1996 January,], [84, CEMBUREAU, 2006].

Electricity use is also determined by the nature of the products, through the use of milling requirements. In some cases, the use of electricity was minimised by replacing old raw material mills with new ones. Table 1.19 gives an overview of the relationship between the energy consumption of the different grinding techniques. It has to be noted that it is not always possible to replace one mill by another grinding device. Furthermore, it is worth mentioning that an assessment of the most appropriate grinding technique should always also consider the economic aspects.

Grinding process	Energy consumption	Maintenance requirements	Drying capacity	Suitability for grinding to great fineness
Ball mill	100 %	Minor	Average	Good
Gutbett roller mill	65 to 50 %	Minor to major	Low <sup>(1)</sup>	Average
Vertical roller mill	75 to 70 %	Average	High	Average
<sup>(1)</sup> Drying in classifier Source: [60, VDI 2094 Germany, 2003] [76, Germany, 2006]				

**Table 1.19: Comparison of grinding techniques based on key characteristics**

### 1.3.3.3 Consumption of waste fuels

To cover the necessary energy demand, waste fuels as well as conventional fuels are used and the consumption of waste fuels has consistently increased over the last few years. In 2004 in Europe, 6.1 million tonnes of different types of wastes were used as fuels in cement kilns. Of these wastes, about one million tonnes were hazardous. In EU-23+ countries (see Glossary), substitution of traditional fuels by waste fuels is increasing sharply, rising from 3 % in 1990 to about 17 % in 2007, equivalent to saving about 4 million tonnes of coal [74, CEMBUREAU, 2006].

However, great differences can be observed between Member States with similar opportunities to increase substitution. In 2007, individual plants were already reaching substitution rates of more than 80 %. Up to 100 % of the energy consumption can be utilised by waste fuels, e.g. at a dry process kiln system, which consists of a rotary kiln with a four stage, two-string preheater and planetary cooler. An example is shown in Section 6.2.2.1.

It has to be noted that of these wastes, the calorific values vary very widely, from 3 to 40 MJ/kg. Literature shows that conventional fuels have calorific values (average, net) of, e.g. 26 – 30 MJ/kg for typical coal, 40 – 42 MJ/kg for typical fuel oil while solid waste can have a calorific value of 8.5 MJ/kg, and plastic material has a calorific value of up to 40 MJ/kg [143, Williams, 2005]. Waste fuels with adequate calorific values can replace fossil fuels and leads to fossil fuel savings. However, kilns have to be suitable for burning wastes and circumstances have to be optimised in order to be able to contribute to a high energy efficiency (see Sections 1.3.3.1 and 1.4.2.1.3). Table 1.20 shows examples of typical calorific values of different waste materials:

Examples of types of waste fuels (hazardous and non-hazardous)	Examples of calorific values (MJ/kg)
Wood	Approx. 16
Paper, cardboard	3 – 16
Textiles	up to 40
Plastics	17 – 40
Processed fractions (RDF)	14 – 25
Rubber/tyres	approx. 26
Industrial sludge	8 – 14
Municipal sewage sludge	12 – 16
Animal meal, fats	14 – 18, 27 – 32
Animal meal (carcase meal)	14 – 21.5
Coal/carbon waste	20 – 30
Agricultural waste	12 – 16
Solid waste (impregnated sawdust)	14 – 28
Solvents and related waste	20 – 36
Oil and oily waste	25 – 36
Oil-shale based fuel mix (85 – 90 % oil-shale)	9.5
Sewage sludge (moisture content >10 %)	3 – 8
Sewage sludge (moisture content <10 to 0 %)	8 – 13

*Source: [75, Estonia, 2006] [168, TWG CLM, 2007] [180, Mauschitz, 2004]*

**Table 1.20: Examples of calorific values for different types of wastes used as fuels in the EU-27**

It has to be noted that depending on the different parameters (see Section 1.4.2.1.3), the annual average specific thermal energy demand also can increase, as shown in examples from the UK and Austria given below.

In example plants in the UK, the (net) calorific value of waste fuels used, e.g. derived from municipal, commercial and/or industrial wastes, can vary between 15 and 23 MJ/kg. However, in one plant a thermal substitution rate of 25 % of the total fuel used was reported which is equivalent to 30000 tonnes of coal. Since the waste fuels have a lower calorific value, the quantity of waste fuels required is 44 118 t [153, Castle Cement UK, 2007], [154, CEMEX UK, 2006]. Another example shows that 125 000 t waste fuels have to be used to replace 100 000 t coal. This refers to 20 % more waste fuels used [81, Castle Cement UK, 2006].

In Austria between 1997 and 2004, the use of fossil fuels was constantly decreasing whereas the waste input increased from 19 % in 1997 to 47 % in 2004. The thermal energy demand first decreased from 3554 to 3481 MJ/t clinker in 2000. However, during the period 2000 to 2004 the fuel mix significantly changed (see Section 6.2.2.2, Table 6.21), with a significant decrease of coal (from 44.9 to 17.6 %) and, at the same time, a significant increase in using petcoke (from 3.2 to 16.0 %) and wastes, such as plastics (from 9.1 to 17.6 %) and other waste fuels (from 2.4 to 10.2 %) [92, Austria, 2006].

Furthermore, information regarding the examples of calorific values calculated for different types of waste treated and calculation examples for calorific values from waste can be found in the Reference Document on Best Available Techniques for Waste Incineration [57, European Commission, 2005].

The increase in the use of non-hazardous wastes is more significant than the increase in the use of hazardous wastes. This reflects societal evolution (increase in sewage sludge, animal meal, processed urban waste), as well as their increased focus on waste classification. With a thermal substitution rate of 17 % on average, which is as high as 100 % at times in some countries, considered that the use of wastes as fuels and raw materials in the clinker burning process is to be common practice. Out of the 6 million tonnes, about 10 % is biomass. Substitution rates of waste fuels used in EU-23+ countries are shown in Table 1.22 [74, CEMBUREAU, 2006], [75, Estonia, 2006], [76, Germany, 2006], [81, Castle Cement UK, 2006], [92, Austria, 2006], [107, Belgium, 2006], [112, Czech Republic, 2006].

Consumptions of different hazardous and non-hazardous wastes used as fuels for firing in EU-27 cement kilns are shown in Table 1.21 and Figure 1.21. The total consumption of waste fuels in EU-27 cement kilns increased from 2003 to 2004 [74, CEMBUREAU, 2006].

Types of waste fuels					
Group Nr. <sup>(1)</sup>	Type of waste	Quantities in 1000 tonnes			
		2003		2004	
		Hazardous	Non-hazardous	Hazardous	Non-hazardous
1	Wood, paper, cardboard	0.000	214.991	1.077	302.138
2	Textiles	0.000	19.301	0.000	8.660
3	Plastics	0.000	354.070	0.000	464.199
4	RDF	4.992	570.068	1.554	734.296
5	Rubber/tyres	0.000	699.388	0.000	810.320
6	Industrial sludge	52.080	161.660	49.597	197.720
7	Municipal sewage sludge	0.000	174.801	0.000	264.489
8	Animal meal, fats	0.000	1313.094	0.000	1285.074
9	Coal/carbon waste	1.890	137.213	7.489	137.013
10	Agricultural waste	0.000	73.861	0.000	69.058
11	Solid waste (impregnated sawdust)	164.931	271.453	149.916	305.558
12	Solvents and related waste	425.410	131.090	517.125	145.465
13	Oil and oily waste	325.265	181.743	313.489	196.383
14	Others	0.551	199.705	0.000	212.380
Total		975.119	4502.435	1040.247	5133.353

(<sup>1</sup>) Each grouping spans several EWC listings, see Table 6.1 in Section 6.2.1  
Source: [74, CEMBUREAU, 2006]

**Table 1.21: Consumption of different types of waste used as fuels in EU-27 cement kilns in 2003 and 2004**

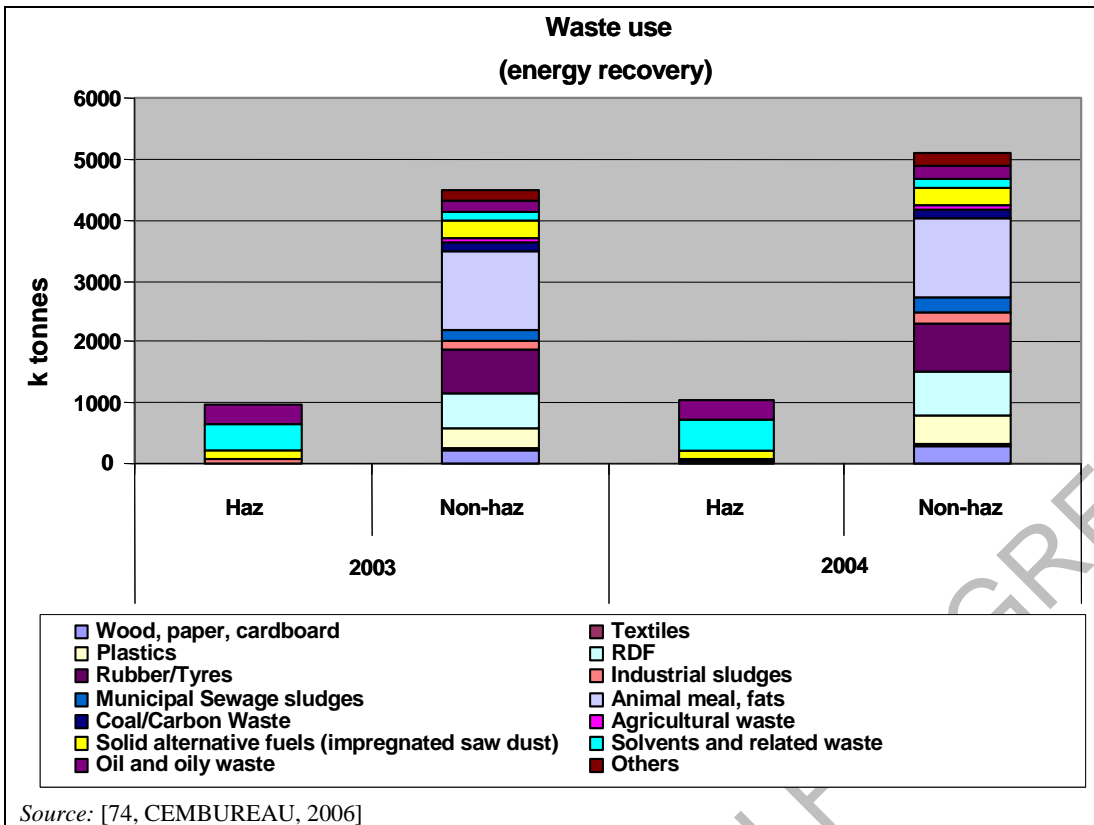


Figure 1.22: Consumption of different types of hazardous and non-hazardous waste used as fuel in cement kilns in the EU-27

Country	Permitted capacities for waste fuels (t/yr)		Amount of waste fuels used (t/yr)		Percentage of heat release (%)			
	National range <sup>(1)</sup>	National average	National range <sup>(1)</sup>	National average	Hazardous waste		Non-hazardous waste	
					National range <sup>(1)</sup>	National average	National range <sup>(1)</sup>	National average
Austria <sup>(3)</sup>	10 000 – 35 000	-	9 500 – 39 000	30 000	30 – 45	12	15 – 50	35
Belgium, Netherlands, Luxembourg	-	-	58 500 – 402 000	138 930	0 – 25	11	21 – 30	24
Czech Republic	90 000 <sup>(2)</sup>	-	-	40 000	0 – 40	15	0 – 100	37
Denmark, Finland, Sweden, Norway, Ireland	300 000 <sup>(2)</sup>	-	22 000 – 120 000	75 000	2 – 20	15	24 – 35	32
Estonia, Latvia, Poland, Hungary	15 000 – 380 000	125 000	8 000 – 67 369	27 271	13.4 – 14	13.7	16 – 26.1	17.5
France	125 000 – 265 000	-	300 – 113 000	37 374	0 – 41.2	14	0.4 – 52	14.6
Germany	-	-	218 157 <sup>(2)</sup>	56 857	0 – 25	5.2	76 <sup>(2)</sup>	43.6
Greece, Portugal, Romania, Slovenia	20 000 – 500 000	20 506	640 – 60 000	9 196	0 – 3.8	0.7	0.4 – 15.6	2
Italy	5 000 – 115 000	28 000	5 300 – 90 600	13 100	1.3 – 21	12	0.9 – 37	11.3
Spain	8 800 – 100 000	43 000	2 000 – 36 000	15 500	0 – 27.8	4.8	2 – 25	8.5
United Kingdom	25 000 – 788 400	182 337	0 – 55 960	24 086	0 – 27.6	6	0 – 40	7.8

Note: Figures are aggregated from EU-23+ countries' replies  
<sup>(1)</sup> Minimum – maximum  
<sup>(2)</sup> Maximum  
<sup>(3)</sup> Only 2004 figures  
Source: [168, TWG CLM, 2007] [178, CEMBUREAU, 2008]

**Table 1.22: Substitution of waste fuels for cement production in EU-23+ countries**

### 1.3.4 Emissions to air

Emissions to air and noise emissions arise during the manufacture of cement. Furthermore with regard to the use of waste, odours can arise, e.g. from the storage and handling of waste (see Section 1.3.8). In this section, ranges of air pollutant emissions are presented for the process of cement production, including other process steps, such as the storage and handling of, e.g. raw materials, additives and fuels including waste fuels.

The **Directive** includes a general indicative list of the main air-polluting substances to be taken into account, if they are relevant for fixing emission limit values. Relevant to cement manufacture including the use of waste are:

- oxides of nitrogen (NO<sub>x</sub>) and other nitrogen compounds
- sulphur dioxide (SO<sub>2</sub>) and other sulphur compounds
- dust
- total organic compounds (TOC) including volatile organic compounds (VOC)
- polychlorinated dibenzo-p-dioxins and dibenzofurans (PCDD and PCDF)
- metals and their compounds
- hydrogen fluoride (HF)
- hydrogen chloride (HCl)
- carbon monoxide (CO).

Not mentioned on the list, but considered to be relevant for cement production is carbon dioxide (CO<sub>2</sub>). Regarding CO<sub>2</sub> emissions and the emissions trading scheme, general information can be found in the Directive 2003/87/EC of the European Parliament and the Council of 13 October 2003 establishing a scheme for greenhouse gas emissions allowance trading within the Community and **subsequent amendment by Directive 2009/29/EC** [99, European Union, 2003] [191, European Union, 2009]. Furthermore, emissions of NH<sub>3</sub> may be considered to be relevant, especially when using secondary techniques for NO<sub>x</sub> reduction, e.g. SNCR.

The main emissions from the production of cement are emissions to air from the kiln system. These derive from the physico-chemical reactions involving the raw materials and the combustion of fuels. The main constituents of the exit gases from a cement kiln are nitrogen from the combustion air; CO<sub>2</sub> from calcination of CaCO<sub>3</sub> and combustion of fuel; water vapour from the combustion process and from the raw materials; and excess oxygen.

In all kiln systems, the solid material moves countercurrently to the hot combustion gases. This countercurrent flow affects the emissions of pollutants, since it acts as a built-in circulating fluidised bed. Many components that result from the combustion of the fuel or from the transformation of the raw material into clinker remain in the gas phase only until they are absorbed by, or condensed on, the raw material flowing countercurrently.

The adsorptive capacity of the material varies with its physico-chemical state. This, in turn, depends on its position within the kiln system. For instance, material leaving the calcination stage of a kiln process has a high calcium oxide content and therefore has a high absorptive capacity for acid species, such as HCl, HF and SO<sub>2</sub>.

Emission data from kilns in operation is given in Table 1.23. The emissions ranges within which kilns operate depend largely on the nature of the raw materials; the fuels; the age and design of the plant; and also on the requirements laid down by the permitting authority. For example, the concentration of impurities and the behaviour of the limestone during firing/calcination can influence emissions, e.g. the variation of the sulphur content in the raw material plays an important role and has an effect on the range of the sulphur emissions in the exhaust gas.

Reported emissions from european cement kilns <sup>(1)</sup>			
Pollutant	mg/Nm <sup>3</sup>	kg/tonne clinker	tonnes/year
NO <sub>x</sub> (as NO <sub>2</sub> )	145 – 2040	0.33 – 4.67	334 – 4670
SO <sub>2</sub>	Up to 4837 <sup>(2)</sup>	Up to 11.12	Up to 11 125
Dust	0.27 – 227 <sup>(3)</sup>	0.00062 – 0.5221	0.62 – 522
CO	200 – 2000 <sup>(4)</sup>	0.46 – 4.6	460 – 11 500
CO <sub>2</sub>	-	Approx. 672 g/t <sub>clinker</sub>	1.5456 million
TOC/VOC	1 – 60 <sup>(5)</sup>	0.0023 – 0.138	2.17 – 267
HF	0.009 – 1.0	0.021 – 2.3 g/t	0.21 – 23.0
HCl	0.02 – 20.0	0.046 – 46 g/t	0.046 – 46
PCDD/F	0.000012 – 0.27 ng I-TEQ/Nm <sup>3</sup>	0.0276 – 627 ng/t	0.0000276 – 0.627 g/year
Metals <sup>(7)</sup>			
Hg	0 – 0.03 <sup>(6)</sup>	0 – 69 mg/t	0 – 1311 kg/year
∑ (Cd, Tl)	0 – 0.68	0 – 1564 mg/t	0 – 1564 kg/year
∑ (As, Sb, Pb, Cr, Co, Cu, Mn, Ni, V)	0 – 4.0	0 – 9200 mg/t	0 – 9200 kg/year
<p><sup>(1)</sup> Mass figures are based on 2300 m<sup>3</sup>/tonne clinker and one million tonnes clinker per year. Emissions ranges are yearly averages and are indicative values based on various measurement techniques. The reference O<sub>2</sub> content is normally 10 %</p> <p><sup>(2)</sup> Values from SO<sub>2</sub> measurements in the clean gas of 253 rotary kilns. 11 measurements are above the scale. Of these, 7 are of '0' substitution rate, 3 are '0 – 10', and one is 'above 40'. High SO<sub>2</sub> emissions are to be expected when the raw materials contain volatile sulphur compounds (e.g. Pyrite). Indeed, these oxidisable compounds may be converted to SO<sub>2</sub> as early as in the upper cyclone stages. This SO<sub>2</sub> can be captured in the raw mill by the finely ground raw material</p> <p><sup>(3)</sup> The figures are values from continuous dust measurements in the clean gas of 253 rotary kilns. 8 measurements are above the scale. The emission levels largely depend on the state of the abatement equipment</p> <p><sup>(4)</sup> In some cases, CO emissions can be higher than 2000 mg/Nm<sup>3</sup> and up to 5000 mg/Nm<sup>3</sup> (11.5 kg/tonne clinker), e.g. Due to NO<sub>x</sub> reduction</p> <p><sup>(5)</sup> Yearly average values from 120 measurements; only a few values range above 60 mg/Nm<sup>3</sup> (up to 122.6 mg/Nm<sup>3</sup> or 0.28 kg/tonne clinker)</p> <p><sup>(6)</sup> Collected from 306 spot measurements with an average value of 0.02 mg/Nm<sup>3</sup> and an upper value of 0.57 mg/Nm<sup>3</sup> (1311 mg/tonne clinker)</p> <p><sup>(7)</sup> '0' implies LOD=level of detection</p> <p>Source: [8, CEMBUREAU, 2001] [9, CEMBUREAU, 1997 November] [12, Netherlands, 1997] [19, Haugh, 2001], [29, Lohse, 2001] [97, CEMBUREAU, 2007] [168, TWG CLM, 2007]</p>			

**Table 1.23: Data of emissions ranges from European cement kilns**

Typical kiln exhaust gas volumes expressed as m<sup>3</sup>/tonne of clinker (dry gas, 101.3 kPa, 273 K) are between 1700 and 2500 for all types of kilns [8, CEMBUREAU, 2001]. Suspension preheater and precalciner kiln systems normally have exhaust gas volumes of around 2300 m<sup>3</sup>/tonne of clinker (dry gas, 101.3 kPa, 273 K).

There are also channelled emissions of dust from other sources, such as grinding (milling) and handling operations, raw materials, solid fuel and product. There is a potential for the diffuse emissions of dust from any outside storage of raw materials and solid fuels as well as from any materials transport systems, including cement product loading. The magnitude of these emissions can be significant if these aspects are not well engineered or maintained and being released at a low level can lead to local nuisance problems.

### 1.3.4.1 Dust (particulate matter)

#### 1.3.4.1.1 Channelled dust emissions

Traditionally, the emissions of dust (PM), particularly from kiln stacks, have been one of the main environmental concerns in relation to cement manufacture. The main sources of dust emissions are the raw material preparation process (raw mills), grinding and drying units, the clinker burning process (kilns and clinker coolers), the fuel preparation and cement grinding unit (mills). Subsidiary processes of a cement plant lead to dust emissions, independent of whether waste is used or not, such as:

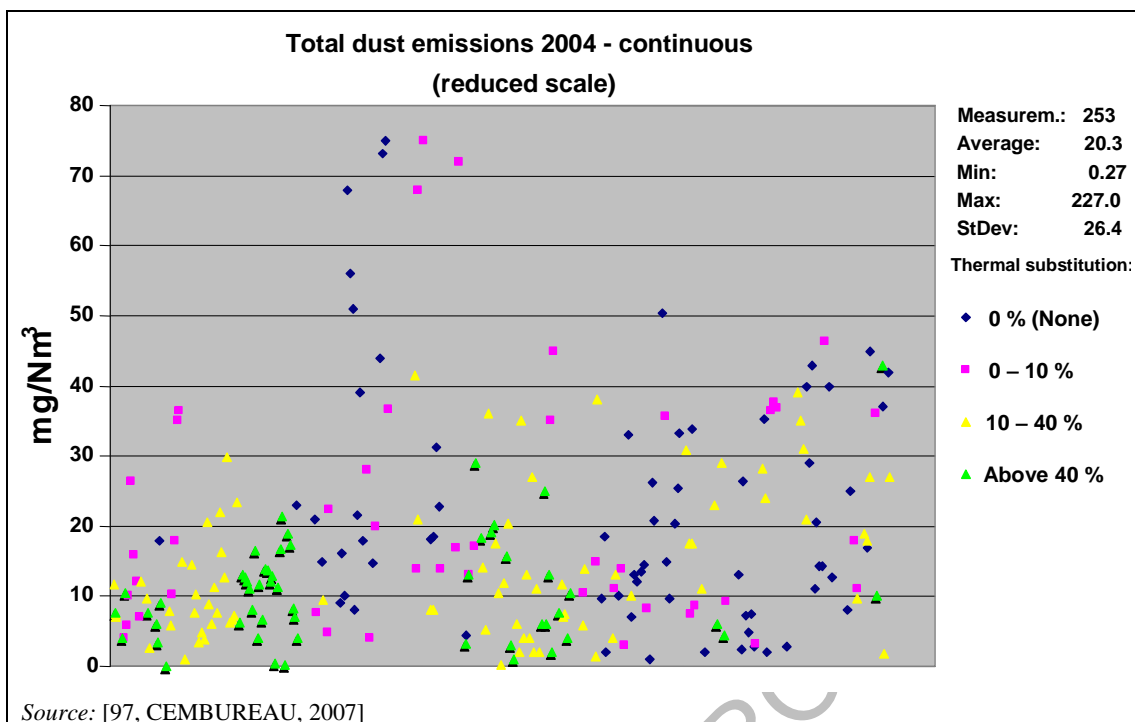
- crushing of raw materials
- raw material conveyors and elevators
- storage for raw materials and cement
- grinding mills for raw materials, cement and coal
- storage of fuels (petcoke, hard coal, lignite) and
- dispatch of cement (loading).

In all these processes, large volumes of gases flow through dusty materials. In cases like crushing, grinding and dispatch, equipment is kept under slight suction and these sources are normally equipped with fabric filters. The design and reliability of modern electrostatic precipitators and fabric filters ensure dust emissions can be reduced to levels where they cease to be significant; emission levels of below 10 mg/Nm<sup>3</sup> (daily average values) are achieved in 37 % of the reported installations. Examples of system types and the amount of filter dust and dust extraction are shown in Table 1.24.

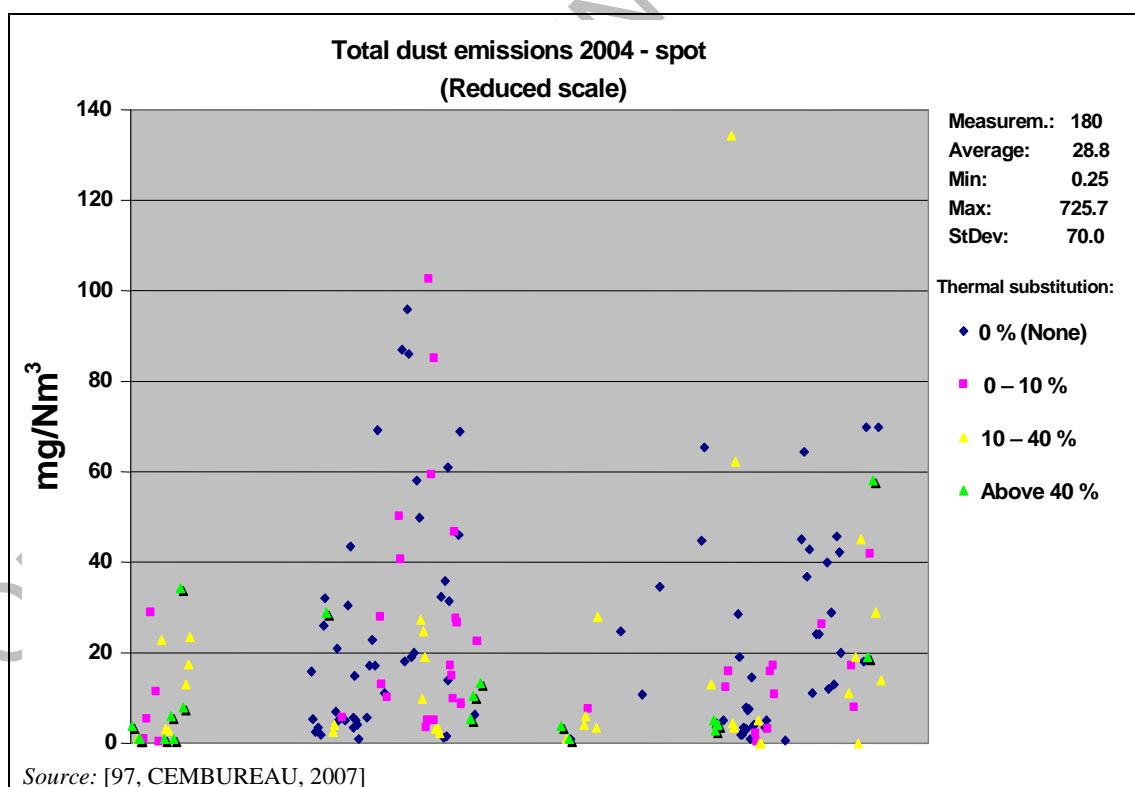
Total dust emissions are continuously measured at 253 rotary kilns and spot dust measurements are collected from 180 rotary kilns, as shown in Figure 1.23 and Figure 1.24. These measurements are all taken from different plants located in EU-27 and EU-23+ countries (see Glossary). The thermal substitution is marked in this figure by using different colours. Most of the dust emissions range between 0.27 and less than 30 mg/Nm<sup>3</sup>. Continuously measured emissions were reported as the annual average of 24 hour averages [97, CEMBUREAU, 2007]. Measured values relate to 1 m<sup>3</sup> of dry gas under standard conditions.

Furthermore, typical clean gas dust contents (daily average values) are attained by rotary kiln systems equipped with an ESP range of between <10 and 30 mg/Nm<sup>3</sup>. After flue-gas abatement with fabric filters, reported dust emissions ranges from <10 to 20 mg/Nm<sup>3</sup>, as a daily average value [92, Austria, 2006], [75, Estonia, 2006], [76, Germany, 2006], [90, Hungary, 2006], [112, Czech Republic, 2006].





**Figure 1.23:** Ranges of emission values from continuous dust measurements in the clean gas from 253 rotary kilns in the EU-27 and EU 23+ countries



**Figure 1.24:** Dust emission values from 180 spot dust measurements in the clean gas of rotary kilns in the EU-27 and EU 23+ countries

Table 1.24 shows examples of some types of ESPs and fabric filters. The values represent typical ranges and the values in brackets refer to extreme values that have been reported in some individual cases. The overview also shows an estimation of filter dust and dust extraction where applicable. Compound and direct operation are related to mill operations (mill on, mill off).

Types of systems and operational data for dust reduction			
Parameter	Unit	ESPs	Fabric filters
Year of construction		1962 – 2004	1999 – 2005
Pressure loss	hPa	1 – 8	( <sup>2</sup> )( <sup>1</sup> ) 10 – 12
Temperature	°C	90 – 190	90 – 160( <sup>2</sup> )
Electric energy demand	kWh/t clinker	1 – 4	0.1 – 0.2
Fan power demand	kWh/t clinker	0.15 – 1.2	1.5 – 1.8
Total energy demand	kWh/t clinker	1.15 – 5.2	1.6 – 2.0
Amount of filter dust and dust extraction			
Parameter	Unit	Compound operation	Direct operation
Amount of filter dust	kg/t clinker	54 – 144 (1718)( <sup>1</sup> )	(10 – 70)( <sup>1</sup> ) 80 – 200
Dust extraction	kg/t clinker	0 – 35	0 – 66 (165)( <sup>1</sup> )
<sup>(1)</sup> Reference to extreme values that have been reported in some individual cases.			
<sup>(2)</sup> 240 °C was reported by using glass fibres with a PTFE membrane.			
Source: [76, Germany, 2006], [103, CEMBUREAU, 2006]			

**Table 1.24:** Example of system types used for dust extraction, operational data and energy demand

In some cases, ESPs will have to be shut down during elevated CO levels in the flue-gases for safety reasons (CO trips). To preclude any operating trouble, elevated CO concentrations in exhaust gas and the resultant formation of explosive mixtures must be reliably ruled out. An automatic CO monitoring device needs to monitor the flue-gas continuously. During different phases of the kiln firing process as well as during shutdowns and start-ups of the kiln system, examples of CO trips were reported in different ranges and time periods. In Ireland in 2006, in some cases during CO trips dust emissions above 60 and up to 130 mg/Nm<sup>3</sup> (half hourly average values) have been reported with frequencies of between one to six times per month. Of these, ESP trip-outs of between 1 – 13 minutes/trip and a total duration of up to 184 minutes have been reported [159, Ireland, 2006]. However, frequencies of CO trips were minimised, e.g. at German cement plants, and examples of total duration ranges of between 1 and 29 minutes per year, respectively <0.001 – 0.009 % of the total kiln operation were reported as shown in Table 1.25.

Year	Total duration	
	(minutes)	(% of total kiln operation time)
2000	12	0.003
2001	29	0.009
2002	1	<0.001
2003	6	0.001
2004	5	0.001
Source: [158, Germany, 2007]		

**Table 1.25:** Examples of frequencies of CO trips in a German cement plant

#### 1.3.4.1.2 Fine dust emissions PM<sub>10</sub> and PM<sub>2.5</sub>

Dust emissions of PM<sub>10</sub> and PM<sub>2.5</sub> consist of fine particles with a grain size of less than 10 and less than 2.5 microns in diameter respectively which can arise in solid form or as aerosols. These types of fine dust may result from a series of physico-chemical reactions involving different precursor gases, such as nitrogen oxides and sulphur, and ammonia reacting to form sulphate, nitrate and ammonium particulate matter, and can cause human health problems. In the cement industry, PM<sub>10</sub> and/or PM<sub>2.5</sub> may arise from the burning and cooling process; however, subsidiary processes (see Section 1.3.4.1.1) can also lead to fine dust formation.

Within the last few years, different measurement methodologies and sampling devices in combination with calculation models have been developed to determine and size segregate these

very fine dust fractions and their distribution, e.g. on the basis of the dust total emissions measured from the flue-gas stream. An investigation from Germany shows that the major part of the total dust emissions is emitted as fine dust, independent of the concentration of the total dust in the waste gas. By applying electrostatic precipitators, approximately 90 % of the dust fraction is less than 10  $\mu\text{m}$  ( $\text{PM}_{10}$ ) and approximately 50 % less than 2.5  $\mu\text{m}$  ( $\text{PM}_{2.5}$ ), as examples from the cement industry show (see Table 1.26). Total dust emissions were measured with filter sampler measurements (plane filter device). Cascade impactors were used to withdraw dust under isokinetic conditions and to separate it into size segregated particulate fractions from the flue-gas stream. Furthermore, examples of fine dust fractions emitted from Irish cement plants can be found in Section 6.2.2.3. Hence a major part of the fine dust can be reduced by reduction of the total dust load. Plants equipped with high efficiency dedusting systems contribute relatively little to the fine dust burden [113, Ireland, 2007], [117, Germany, 2000].

Emissions source		Total dust concentration <sup>(1)</sup> ( $\text{mg}/\text{Nm}^3$ )	Fine dust fraction (%)			Fine dust concentration ( $\text{mg}/\text{Nm}^3$ )		
			<2.5	<10	>10	<2.5	<10	>10
$\mu\text{m}$								
Kiln (ESP) <sup>(2)</sup>	Kiln flue-gas after ESP	15.4	51	87	13	7.9	13.4	2.9
Clinker cooler (ESP)	Clinker cooler flue-gas after ESP	14.0	68	99	1	9.5	13.9	$\leq 0.1$
Cyclone preheater (ESP), direct mode <sup>(3)</sup>	Kiln flue-gas after ESP	2.3	84	97	3	1.9	2.2	$\leq 0.1$
Cyclone preheater (ESP), combined mode <sup>(4)</sup>	Kiln flue-gas after ESP	4.8	66	97	3	3.2	4.7	$\leq 0.1$

<sup>(1)</sup> Total dust measured with filter sampler measurements (plane filter device), size segregation with cascade impactors  
<sup>(2)</sup> Lepol kiln, now shut down  
<sup>(3)</sup> Mill off  
<sup>(4)</sup> Mill on  
 Source: [117, Germany, 2000]

**Table 1.26: Investigation on fine dust distribution in total dust from German cement kilns**

The Regional Air Pollution Information and Simulation model (RAINS) has been extended to explore synergies and trade-offs between the control of local and regional air pollution and the mitigation of global greenhouse gas emissions. This new Greenhouse Gas and Air Pollution Interactions and Synergies model (GAINS) assists in the search for pollution control strategies that maximise benefits across all scales.

The RAINS model shows that  $\text{PM}_{10}$  and  $\text{PM}_{2.5}$  represent 60 % of total particulate matter ( $78 \text{ g}/\text{Nm}^3$ ) in the raw gas (before treatment), as shown in Table 1.27. Examples of dust reduction techniques along with reduction efficiencies can be found in Table 1.28.

Parameter	Raw gas concentration
Total particulate matter (TPM)	130 $\text{g}/\text{Nm}^3$
$\text{PM}_{10}$	42 % of TPM
$\text{PM}_{2.5}$	18 % of TPM

Source: [172, France, 2007]

**Table 1.27: Examples of raw gas concentration of dust according to the RAINS model**

Technique	Reduction efficiency (%)		
	Total particulate matter	PM <sub>10</sub>	PM <sub>2.5</sub>
Cyclone	74.4	52.86	30
ESP 1	95.8	94.14	93
ESP 2	98.982	97.71	96
ESP 3	99.767	99.51	99
Fabric filter	99.784	99.51	99
Wet scrubber	98.982	97.71	96

*Source: [172, France, 2007]*

**Table 1.28:** Examples of dust reduction techniques along with reduction efficiencies according to the RAINS model

#### 1.3.4.1.3 Diffuse dust emissions

Diffuse dust emissions can arise during the storage and handling of materials and solid fuels, e.g. from open storage, conveyors of raw materials, and also from road surfaces because of road transport. Dust arising from packaging and dispatch of clinker/cement can also be significant. The impact of diffuse emissions can be a local increase in levels of dust, whereas process dust emissions (generally from high stacks) can have an impact on the air quality over a much larger area.

Conveyors and elevators are constructed as closed systems, if dust emissions are likely to be released from dusty material. Roads used by lorries are paved and cleaned periodically in order to avoid diffuse dust emissions. In addition, spraying with water at the installation site is used to avoid these emissions. Wherever possible, closed storage systems are used [76, Germany, 2006].

#### 1.3.4.2 Nitrogen oxides

The clinker burning process is a high temperature process resulting in the formation of nitrogen oxides (NO<sub>x</sub>). These oxides are of major significance with respect to air pollution from cement manufacturing plants. They are formed during the combustion process either by a combination of fuel nitrogen with oxygen within the flame or by a combination of atmospheric nitrogen and oxygen in the combustion air.

There are two main sources for the production of NO<sub>x</sub>:

- thermal NO<sub>x</sub>:
  - part of the nitrogen in the combustion air reacts with oxygen to form various oxides of nitrogen
  - is the major mechanism of nitrogen oxide formation in the kiln flame
- fuel NO<sub>x</sub>:
  - compounds containing nitrogen, chemically bound in the fuel, react with oxygen in the air to form various oxides of nitrogen.

Nevertheless, some slight changes in the NO<sub>x</sub> emissions while using wastes may be observed:

- NO<sub>x</sub> from primary firing can be lower if waste fuels include water or require more oxygen (impact on the flame temperature, which is lowered). The effect is comparable to flame cooling
- NO<sub>x</sub> from secondary/precalciner firing can be lower if coarse fuel creates a reducing zone [97, CEMBUREAU, 2007].

Furthermore,  $\text{NO}_x$  may also be formed by the oxidisation of  $\text{NH}_3$ , if this is injected for  $\text{NO}_x$  reduction into an inadequate temperature zone of the kiln where temperatures are less than  $1000\text{ }^\circ\text{C}$ .

Thermal  $\text{NO}_x$  forms at temperatures above  $1050\text{ }^\circ\text{C}$ . For reasons of clinker quality, the burning process takes place under oxidising conditions, under which the partial oxidation of the molecular nitrogen in the combustion air results in the formation of nitrogen monoxide. Thermal  $\text{NO}_x$  is produced mainly in the kiln burning zone where it is hot enough to achieve this reaction. The amount of thermal  $\text{NO}_x$  produced in the burning zone is related to both burning zone temperature and oxygen content (air excess factor). The rate of reaction for thermal  $\text{NO}_x$  increases with temperature; therefore, hard-to-burn mixes which require hotter burning zones will tend to generate more thermal  $\text{NO}_x$  than kilns with easier burning mixes. The rate of reaction also increases with increasing oxygen content (air excess factor). Running the same kiln with a higher back-end oxygen content (air excess factor) will result in a higher thermal  $\text{NO}_x$  generation in the burning zone (although emissions of  $\text{SO}_2$  and/or  $\text{CO}$  may decrease).

$\text{NO}$  and  $\text{NO}_2$  are the dominant nitrogen oxides in cement kiln exhaust gases. Fuel  $\text{NO}_x$  from nitrogen compounds in fuel is of lower importance. In cement rotary kiln systems, formation of fuel  $\text{NO}$  (nitrogen monoxide) in the area of the main firing is insignificant.  $\text{NO}_x$  emissions from a cement kiln are normally related to the airborne nitrogen rather than by the fuel fired. Nitrogen monoxide ( $\text{NO}$ ) accounts for about 95 % and nitrogen dioxide ( $\text{NO}_2$ ) for about 5 % of nitrogen oxides present in the exhaust gas of rotary kiln plants [76, Germany, 2006], [92, Austria, 2006], [97, CEMBUREAU, 2007]. Fuel  $\text{NO}_x$  is generated by the combustion of the nitrogen present in the fuel at the lower temperatures prevailing in a secondary firing unit. Nitrogen in the fuel either combines with other nitrogen atoms to form  $\text{N}_2$  gas or reacts with oxygen to form fuel  $\text{NO}_x$ . In a precalciner, the prevailing temperature is in the range of  $850 - 950\text{ }^\circ\text{C}$ , which is not high enough to form significant thermal  $\text{NO}_x$ , but fuel  $\text{NO}_x$  will occur. Similarly, other types of secondary firing of fuel in the back-end of a kiln system, such as in the kiln riser pipe of a suspension preheater kiln or the calcining chamber of a preheater grate, may give rise to fuel  $\text{NO}_x$ . Therefore, in precalciner kilns, where up to 60 % of the fuel can be burned in the calciner, fuel  $\text{NO}_x$  formation significantly contributes to the total  $\text{NO}_x$  emissions. The thermal  $\text{NO}_x$  formation in these kilns is much lower when compared to kilns where all the fuel is burned in the sintering zone.

The  $\text{NO}_x$  emissions vary depending on which kiln process is used. Besides temperature and oxygen content (air excess factor),  $\text{NO}_x$  formation can be influenced by flame shape and temperature, combustion chamber geometry, the reactivity and nitrogen content of the fuel, the presence of moisture, the available reaction time and burner design.

On a yearly average, the European cement kilns emit about  $785\text{ mg NO}_x/\text{Nm}^3$  (expressed as  $\text{NO}_2$ ) with a minimum of  $145\text{ mg}/\text{Nm}^3$  and a maximum of  $2040\text{ mg}/\text{Nm}^3$ . In 2004, example data of  $\text{NO}_x$  emissions were collected from different plants located in several EU-27 and EU-23+ countries (see Glossary) and categorised by the thermal substitution rate as shown in Figure 1.25 and Figure 1.26. Continuously measured emissions were reported as the annual average of 24 hour averages. Measured values relate to one  $\text{m}^3$  of dry gas under standard conditions [94, European Union, 2004], [97, CEMBUREAU, 2007].

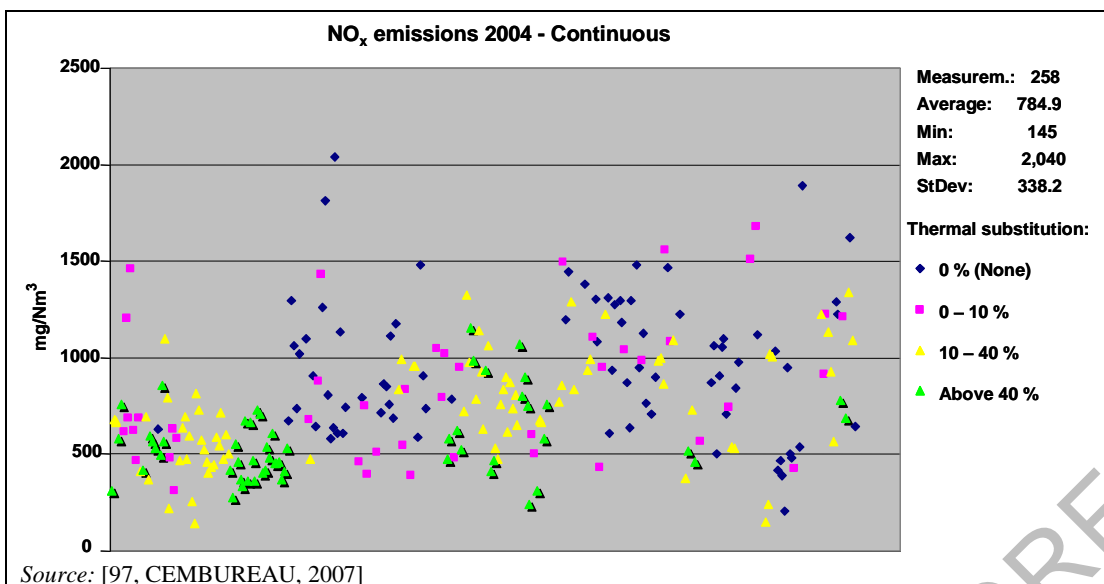


Figure 1.25: NO<sub>x</sub> emissions (expressed as NO<sub>2</sub>) from cement kilns in the EU-27 and EU-23+ countries in 2004 categorised by substitution rate

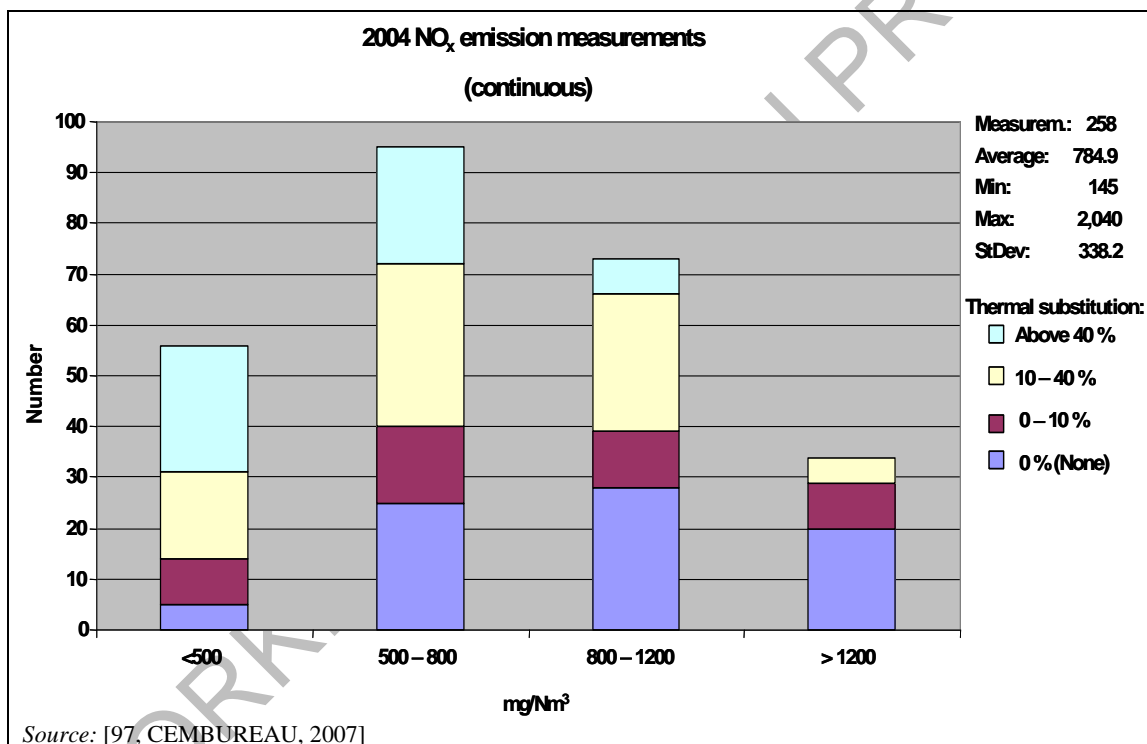


Figure 1.26: Distribution of measurements categorised by the thermal substitution rate of NO<sub>x</sub> levels

In Austria, the yearly average of NO<sub>x</sub> emissions in 2004 was 645 mg/Nm<sup>3</sup> (yearly mean average, based on continuous measurement, standard conditions) and these values varied from 313 – 795 mg NO<sub>x</sub>/Nm<sup>3</sup>, measured as yearly average values. The highest and the lowest ranges were measured at different plants. All Austrian kilns use primary techniques, three kilns have flame cooling, two kilns have staged combustion and five kilns are equipped with the SNCR technique, of which two are in a pilot phase. In 2007, all Austrian cement kilns were equipped with SNCR [92, Austria, 2006].

In Germany in 2006, eight kilns were operated with the staged combustion technique while 34 kilns used the SNCR technique for NO<sub>x</sub> reduction. Ranges of NO<sub>x</sub> emissions concentrations of 200 – 800 mg/Nm<sup>3</sup> as yearly average values were measured in the clean gas from 43 rotary kilns. Since 2007 due to national legislation, German cement kilns have to keep a NO<sub>x</sub> emission limit of at least 500 mg/Nm<sup>3</sup>. Most SNCR installations operating in Germany are designed and/or operated for NO<sub>x</sub> reduction rates of 10 – 50 % and NO<sub>x</sub> emission levels of below 500 mg/Nm<sup>3</sup>. In combination with process-integrated techniques, emission values of between 200 – 500 mg/Nm<sup>3</sup> as a daily average value are achieved depending on the individual emission limit value determined in the permit [76, Germany, 2006], [168, TWG CLM, 2007], [173, Germany, 2007].

In Sweden, the high efficiency SNCR technique has been in operation since 1997 in three cement kilns. Since then, the long term NO<sub>x</sub> emissions have been around 200 mg/Nm<sup>3</sup>. The yearly average value in 2004 was 221 mg/Nm<sup>3</sup>, while monthly average values range from 154 to 226 mg/Nm<sup>3</sup>. The NO<sub>x</sub> load is between 130 and 915 t/yr [114, Sweden, 2006].

NO<sub>x</sub> emissions in Finnish cement plants range between 500 and 1200 mg/Nm<sup>3</sup> measured as a yearly average value [63, Finland, 2006]. In the Czech Republic, NO<sub>x</sub> emissions in a range of 400 to 800 mg/Nm<sup>3</sup> have been measured [112, Czech Republic, 2006]. In France in 2001, the average measure of NO<sub>x</sub> emissions from 33 cement plants was 666 mg/Nm<sup>3</sup> [116, France, 2002]. On a wet long cement kiln in Denmark, SNCR is applied and with a reduction efficiency of 40 – 50 % a NO<sub>x</sub> emission level of <800 mg/Nm<sup>3</sup> were reported [182, TWG CLM, 2008]

For white cement production, some raw materials have difficulties in becoming clinker during the firing process and they need higher flame temperatures, depending on their crystallography or mineralogy. One special case is that of white clinker, where the absence of fusing metals leads to clinker temperatures of about 150 °C higher than for grey clinker. Higher flame temperatures also lead to higher thermal NO<sub>x</sub> formation [120, Spain, 2007].

Techniques for NO<sub>x</sub> reduction in the cement industry are described in Section 1.4.5.1. Furthermore, the in 2008 known numbers of full scale installations with NO<sub>x</sub> abatement techniques in the EU-27 and EU-23+ countries are presented in Table 1.33 in Section 1.4.5.1.

Flame cooling is used for NO<sub>x</sub> reduction. Reduction rates/efficiencies from 10 – 35 % have been reported. Reported emissions ranges which have been achieved by using flame cooling are shown in Figure 1.27. A level of less than 500 mg/Nm<sup>3</sup> was achieved from two plants, emissions ranges of 500 – 800 mg/Nm<sup>3</sup> were achieved by seven plants, and ranges of 800 - 1000 mg/Nm<sup>3</sup> were achieved by 11 plants (yearly average values). In comparison to these emissions ranges achieved by several plants, Figure 1.28 shows the NO<sub>x</sub> emissions ranges which were achieved by several cement plants without applying flame cooling. Just a small numbers of plants achieve the lower NO<sub>x</sub> emissions range.

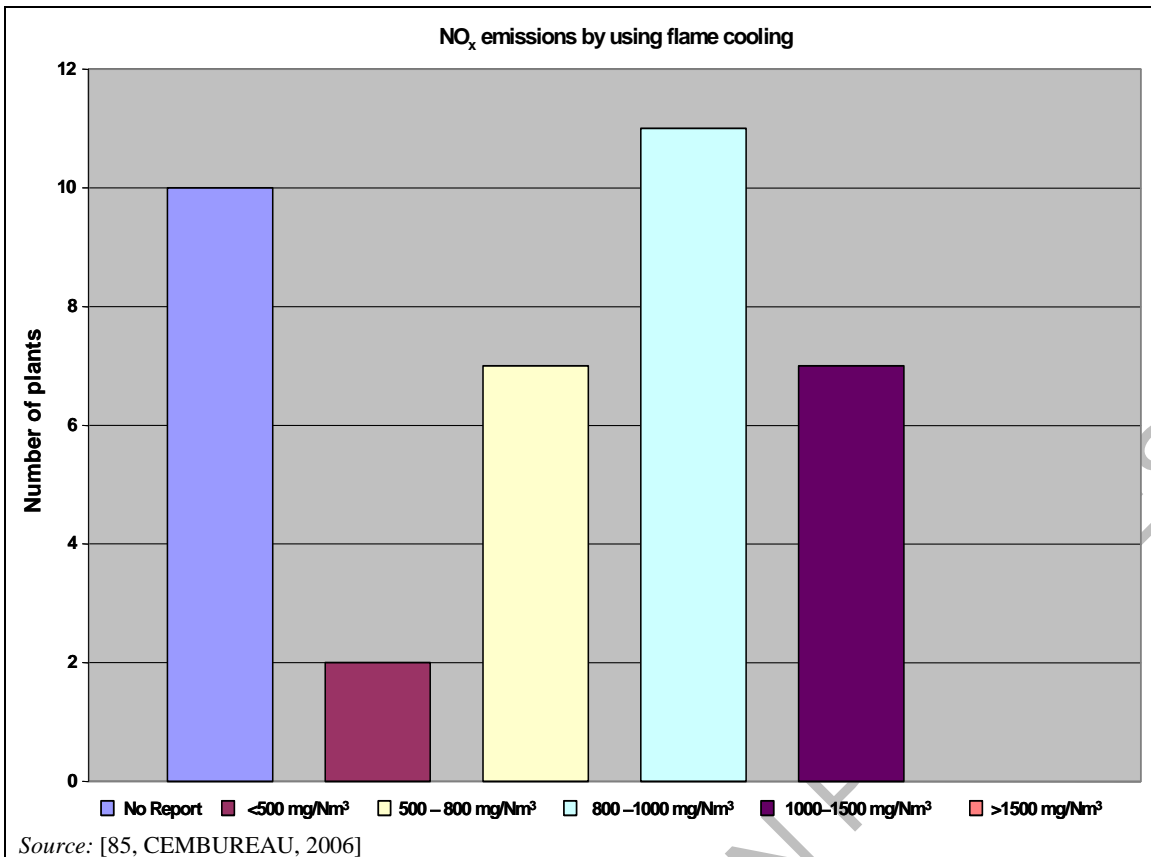


Figure 1.27: Achieved NO<sub>x</sub> emissions ranges by using flame cooling in several cement plants in the EU-23+

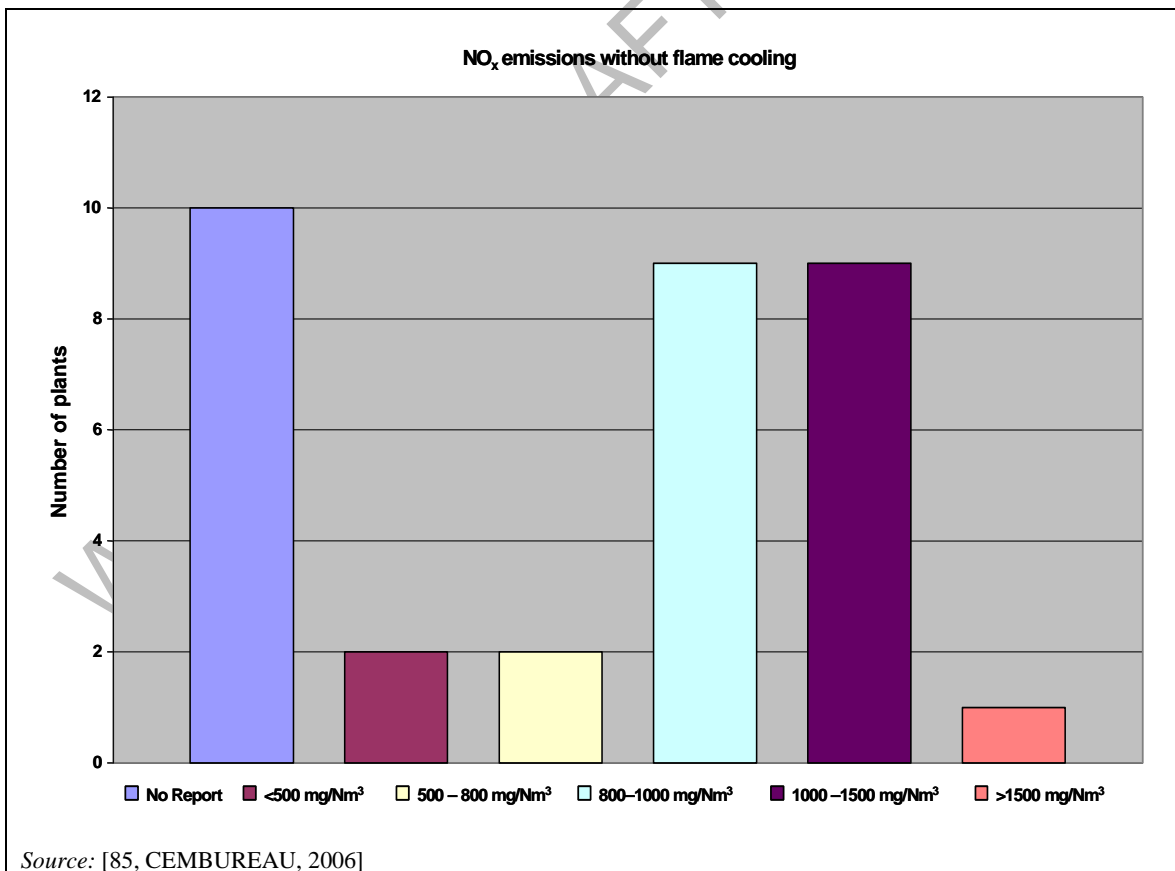


Figure 1.28: Achieved NO<sub>x</sub> emissions ranges from several cement plant in the EU-23+ not using flame cooling



As shown in Figure 1.29 and Figure 1.30, the use of SNCR for NO<sub>x</sub> reduction in cement plants reduces the achieved NO<sub>x</sub> emissions range in comparison to cement plants not using SNCR technique (yearly average values).

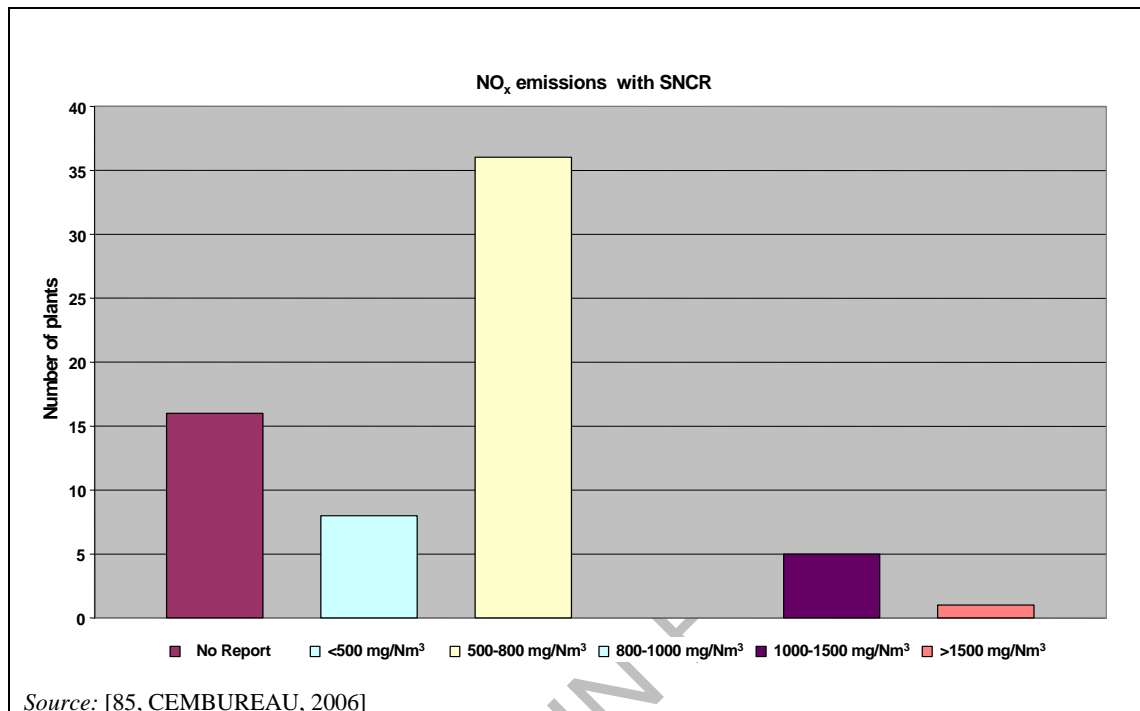


Figure 1.29: NO<sub>x</sub> emissions achieved by several cement plants using SNCR for NO<sub>x</sub> reduction

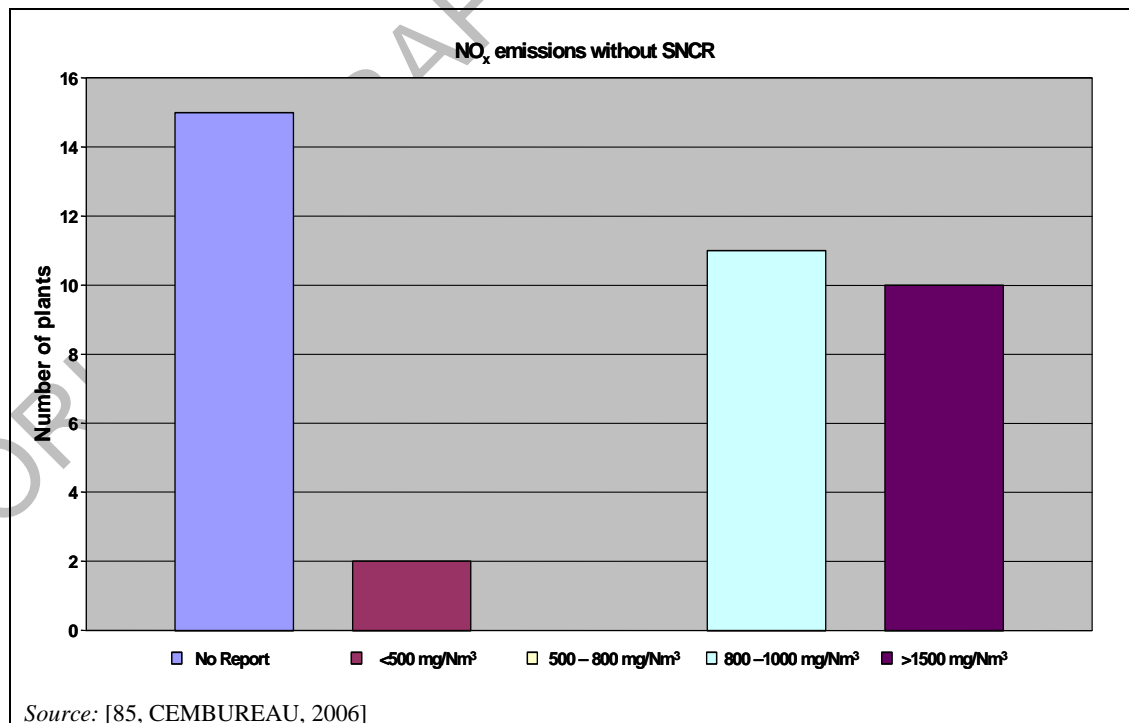


Figure 1.30: NO<sub>x</sub> emissions ranges achieved by several cement plants without using SNCR

### 1.3.4.3 Sulphur dioxide

SO<sub>2</sub> emissions from cement plants depend on the total input of sulphur compounds and the type of process used, and are primarily determined by the content of the volatile sulphur in the raw materials and possibly by the fuels. The production and potential emissions of SO<sub>x</sub> also depend on the sulphur circulation which occurs in the kiln system. The sulphur is emitted from different outputs of the kiln system, such as SO<sub>2</sub> in the exhaust gases, CaSO<sub>4</sub> and other combined compounds in the clinker and the dust. However, the greater part of the sulphur is incorporated in the clinker or discharged from the system by the process.

Depending on their respective deposits, the raw materials may contain sulphur bound as sulphate or sulphide. Sulphates are stable compounds which are only partly thermally decomposed at the high temperatures prevailing in the sintering zone of rotary kiln systems, which may be increased by localised reducing conditions, and the combustion of fuels and wastes. Consequently, sulphur present in sulphate form is more or less completely discharged from the kiln system with the clinker where required for clinker quality. Sulphides, by contrast, are oxidised in the preheater and partly emitted in the form of sulphur dioxides.

Sulphur introduced into the kiln system with the fuels is oxidised to SO<sub>2</sub> and will not lead to significant SO<sub>2</sub> emissions, due to the strong alkaline nature in the sintering zone, the calcination zone and in the lower stage of the preheater. This sulphur enters the calcining zone of the kiln system together with the minor concentrations of SO<sub>2</sub> resulting from partial sulphate decomposition in the sintering zone. In the calcining zone, SO<sub>2</sub> reacts among other things (inter alia) with alkalis and alkali sulphates originating from the raw materials. On contact with the partly decarbonated raw meal, the excess SO<sub>2</sub> is first reacted to CaSO<sub>3</sub> and then to CaSO<sub>4</sub>. These sulphates once again enter the rotary kiln. In this way, sulphur cycles are created, which are at equilibrium with the sulphur discharged via the clinker (Figure 1.31).

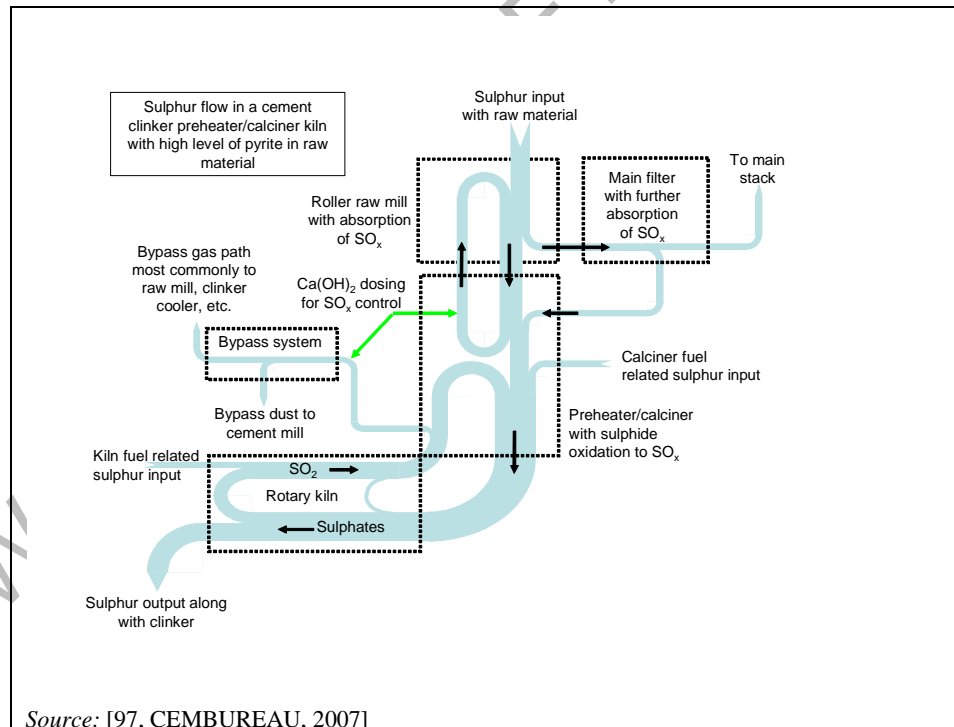


Figure 1.31: Sulphur flow diagram in a cement preheater/precalciner kiln

The calcining area of a rotary kiln offers ideal conditions for SO<sub>2</sub> capture from the kiln exhaust gases. SO<sub>2</sub> emissions may, however, occur when the operating conditions of the kiln system, e.g. the oxygen concentration in the rotary kiln, have not been optimised for SO<sub>2</sub> capture.

Furthermore, various factors may influence the efficiency of the reaction, such as temperature, moisture content, the retention time of the gas, the concentration of oxides in the gaseous phase, the availability of solid surface area, etc. [60, VDI 2094 Germany, 2003], [76, Germany, 2006], [86, EURITS, 2006], [97, CEMBUREAU, 2007].

Elevated SO<sub>2</sub> emissions are to be expected when raw materials containing organic sulphur, and in particular when raw material-borne sulphur is present in a readily oxidisable form, e.g. as pyrite or marcasite. In contrast with the sulphatic raw material components, these readily oxidisable compounds may be converted to SO<sub>2</sub> as early as in the upper cyclone stages.

Under these conditions, raw material-related SO<sub>2</sub> emissions concentrations may be as high as 1.2 g/Nm<sup>3</sup> and in individual cases, even higher, if no secondary emissions control techniques are provided.

However, kilns that use raw materials with little or no volatile sulphur have few problems with SO<sub>2</sub> emissions and emissions concentrations in the flue-gas are below 10 mg/Nm<sup>3</sup> without abatement at some kilns, the SO<sub>2</sub> emissions concentration increases with increased levels of volatile sulphur in the used raw material.

By using secondary control techniques, e.g. utilisation of lime hydrate, the SO<sub>2</sub> emissions can significantly be reduced. Figure 1.32 shows values of SO<sub>2</sub> measurements in the clean gas from cement plants in the EU-25 [97, CEMBUREAU, 2007].

SO<sub>2</sub> is the main (99 %) sulphur compound to be emitted, although some SO<sub>3</sub> is produced and, under reducing conditions, H<sub>2</sub>S could be evolved. Sulphur in the raw material occurring as sulphides and organically combined sulphur will evaporate, and 30 % or more may be emitted from the first stage of a preheater.

In contrast to the calcining area, 40 to 85 % of the SO<sub>2</sub> formed is recaptured in the preheater. Apart from the water vapour content of the kiln exhaust gases, the key influencing parameters for SO<sub>2</sub> capture by the CaCO<sub>3</sub> in the cyclone preheater are the raw gas dust content and in particular, the raw gas oxygen concentration in the uppermost cyclone stage. The excess oxygen (1 to 3 % O<sub>2</sub> maintained in the kiln for satisfactory cement product quality) will normally immediately oxidise any released sulphide compounds to SO<sub>2</sub>. In long kilns the contact between SO<sub>2</sub> and alkaline material is not so good, and sulphur in the fuels, such as waste fuels, can lead to significant SO<sub>2</sub> emissions.

At approximately 10 %, SO<sub>2</sub> capture in the gas conditioning tower/evaporation cooler is relatively low. In the grinding-drying unit, by contrast, material comminution continuously exposes new, highly active particle surfaces which are available for SO<sub>2</sub> capture. The drying process ensures that the gas atmosphere is always enriched with water vapour improving absorption. Experience with plants operating in the compound mode has shown that between 20 and 70 % SO<sub>2</sub> can be captured in the raw mill. Factors influencing SO<sub>2</sub> capture include the raw material moisture, the mill temperature, the retention time in the mill as well as the fineness of the ground material. Thus, it is important that raw milling is optimised so that the raw mill can be operated to act as SO<sub>2</sub> abatement for the kiln [60, VDI 2094 Germany, 2003], [76, Germany, 2006], [86, EURITS, 2006], [97, CEMBUREAU, 2007].

Despite the fact that most sulphur remains in the clinker as sulphate, SO<sub>2</sub> emissions can be significant from raw materials with a high volatile sulphur content and can be regarded as a major pollutant.

#### *Deviation from regular operating conditions*

Events deviating from regular operating conditions lead to an increase of SO<sub>2</sub> emissions, such as combustion carried out under reducing conditions that curtails sulphur incorporation efficiency:

- incomplete combustion in the precalciner or coarse waste fuels are not properly burned in the back-end of the kiln
- an excessively hot burning zone which may occur in kilns burning fuel mix which have a very hard burnability
- excess of sulphur via alkalis in the kiln charge
- extreme levels of sulphur recirculation between the kiln and the preheater stages.

In 2004, example data of SO<sub>2</sub> emissions were collected from different plants located in several EU-27 and EU-23 countries (see Glossary). Continuously measured emissions were reported as the yearly average of 24 hour averages. Measured values relate to 1 m<sup>3</sup> of dry gas under standard conditions. Values of SO<sub>2</sub> measurements in the clean gas were collected from 253 rotary kilns. 11 measurements were above the scale. Of these, seven were of zero substitution rate, three were between 0 and 10 and one of them was above 40, as shown in Figure 1.32 [97, CEMBUREAU, 2007]. However, raw gas concentration ranges of 1400 – 1700 mg/Nm<sup>3</sup> with peaks of up to 3000 mg/Nm<sup>3</sup> have been found in a Swiss cement plant [86, EURITS, 2006].

A large proportion of SO<sub>2</sub> is absorbed and locked into the cement clinker and the cement kiln dust (CKD) as also shown in Figure 1.32. The use of waste fuels does not have an influence on the total SO<sub>2</sub> emissions. In long rotary kilns, the contact between SO<sub>x</sub> and alkaline materials is less efficient and sulphur in the fuels might lead to SO<sub>x</sub> emissions.

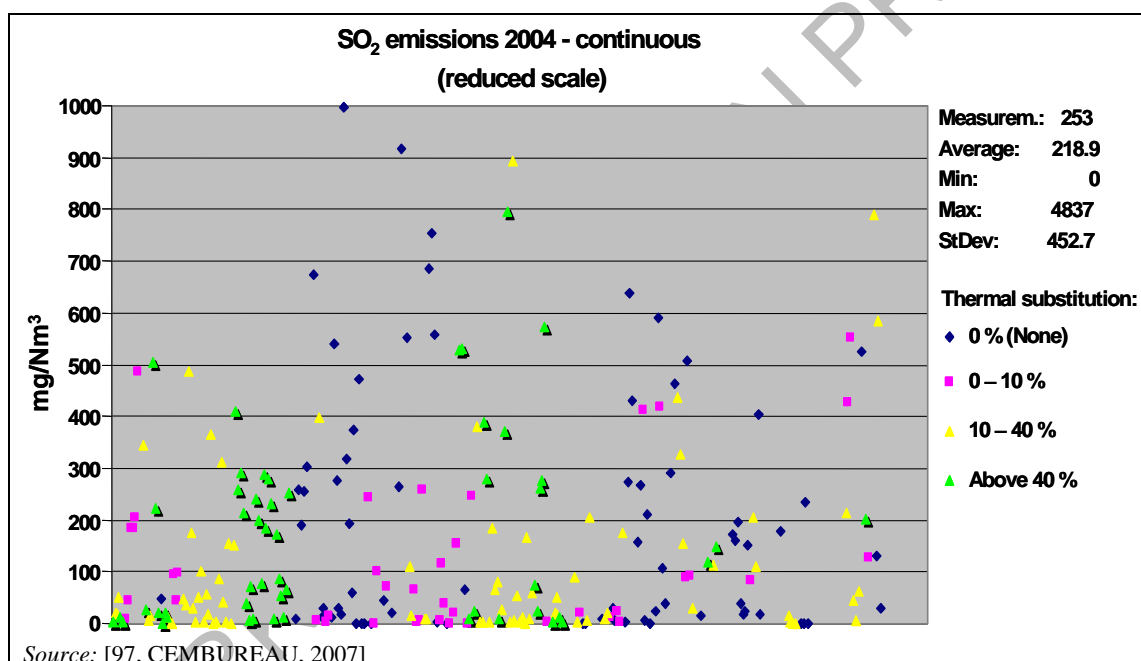
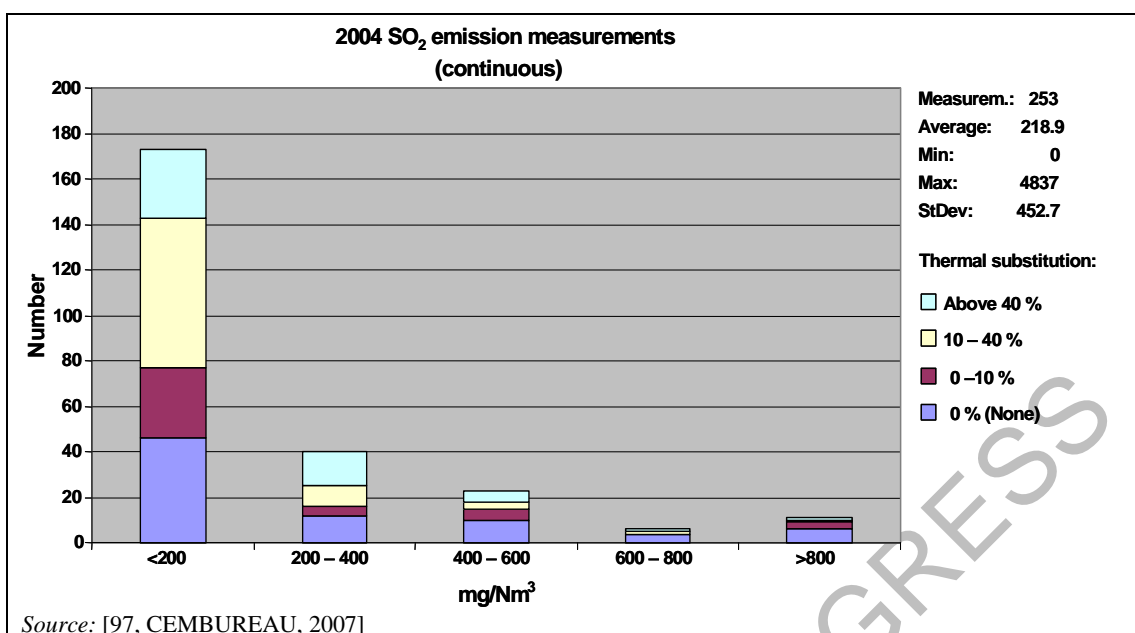


Figure 1.32: Values of SO<sub>2</sub> measurements in the clean gas from cement plants in the EU-27 and EU-23+ countries

The categorisation and distribution of these SO<sub>2</sub> emissions is shown in Figure 1.33 [97, CEMBUREAU, 2007].



**Figure 1.33:** Distribution of measurements categorised by the thermal substitution rate of SO<sub>2</sub> levels

In the case of white cement manufacture, different conditions and their combination might lead, in specific cases, to significantly lower ability for fuel sulphur retention in the clinker, and thus, to higher SO<sub>2</sub> emissions. These conditions are the following:

- hard burnability of raw meal
- low alkali content of the kiln feed because of the high purity of raw materials
- kiln conditions, such as a generally reducing atmosphere
- kiln configuration: Lepol kilns are common and in modern preheater kilns, the number of cyclones can be limited by the chemical composition of the raw material (alkalis-sulphur balance [120, Spain, 2007]).

#### 1.3.4.4 Carbon oxides (CO<sub>2</sub>, CO)

##### 1.3.4.4.1 Carbon dioxide (CO<sub>2</sub>)

The emissions of CO<sub>2</sub> are estimated to be 900 to 1000 kg/tonne grey clinker, related to a specific heat demand of approximately 3500 to 5000 MJ/tonne clinker, but this also depends on fuel type. Due to cement grinding with mineral additions, the emissions of CO<sub>2</sub> are reduced when related to tonnes of cement (compare with Figure 1.19). Approximately 62 % originates in the calcining process and the remaining 38 % is related to fuel combustion. The CO<sub>2</sub> emissions resulting from the combustion of the carbon content of the fuel is directly proportional to the specific heat demand as well as the ratio of the carbon content to the calorific value of the fuel. Emissions of combustion CO<sub>2</sub> have progressively reduced, with a reduction of about 30 % in the last 25 years being accomplished mainly by the adoption of more fuel efficient kiln processes.

Regarding CO<sub>2</sub> emissions and the emissions trading scheme, information can be found in Directive 2003/87/EC of the European Parliament and the Council of 13 October 2003 establishing a scheme for greenhouse gas emissions allowance trading within the Community and subsequent amendment by Directive 2009/29/EC [99, European Union, 2003] [191, European Union, 2009]. Furthermore, information regarding monitoring and reporting of greenhouse gas emissions under the Emissions Trading scheme Directive can be found in Europeans Commission Decision of 29 January 2004 (2004/156/EC) and Commission Decision

of 18 July 2007 (2007/589/EC) [122, European Commission, 2004] [193, European Union, 2007].

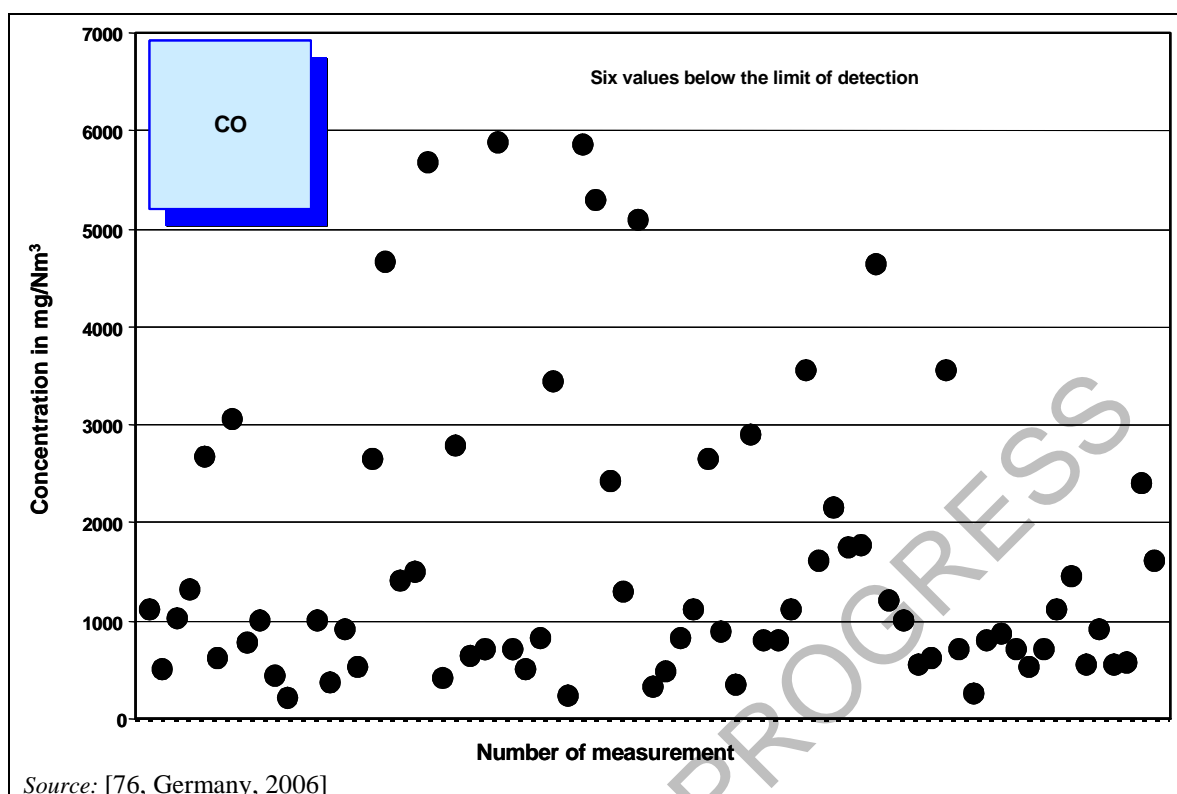
#### 1.3.4.4.2 Carbon monoxide (CO)

The emissions of CO and organically bound carbon during the clinker burning process are caused normally by the small quantities of organic constituents input via the natural raw materials (remnants of organisms and plants incorporated in the rock in the course of geological history). These are converted during kiln feed preheating and become oxidised to form CO and CO<sub>2</sub>. In this process, small portions of organic trace gases, such as total organic carbon, are formed as well. In the case of the clinker burning process, the content of CO and organic trace gases in the clean gas therefore do not allow any conclusions on combustion conditions.

However, additional CO emissions may also result from poor combustion and improper burning conditions in the secondary firing. On the other hand, it has to be pointed out that such an increase in the CO emissions rate coincides with a decrease in the NO<sub>x</sub> emissions. However, the reducing conditions may have a positive effect on SO<sub>x</sub> emissions.

In energy conversion plants, such as power stations, the exhaust gas concentrations of CO and organically bound carbon are a yardstick for the burnout rate of the fuels. By contrast, the clinker burning process is a material conversion process that must always be operated with excess air for reasons of clinker quality. Together with long residence times in the high temperature range, this leads to complete fuel burn up [76, Germany, 2006].

Depending on the raw material deposit, between 1.5 and 6 g of organic carbon per kg clinker are brought into the process with the natural raw material. Tests using raw meals of various origins showed that between 85 – 95 % of the organic compounds in the raw material are converted to CO<sub>2</sub> in the presence of 3 % oxygen, but at the same time 5 – 15 % are converted to CO. The proportion emitted as volatile organic carbon compounds (VOC) under these conditions is well below 1 %. The CO concentration can be as high as 1000 mg/Nm<sup>3</sup>, exceeding 2000 mg/Nm<sup>3</sup> or can even be higher than 5000 mg/Nm<sup>3</sup> in some cases as shown in Figure 1.34. However, most examples of these CO emissions concentration values continuously measured from 29 German rotary kilns are in the range of between 200 and 2200 mg/Nm<sup>3</sup> as the yearly average value (CO detection limit 1.8 – 2.5 mg/Nm<sup>3</sup>) [9, CEMBUREAU, 1997 November], [76, Germany, 2006], [168, TWG CLM, 2007]. Good hopper, transport conveyor and feeder design are essential to ensure that the feed rate of solid fuel is steady with minimal peaks. Otherwise, substoichiometric combustion may occur which can lead to short term peaks of greater than 0.5 % CO. These cause the additional problem that any ESP abatement will have to be switched off automatically to avoid explosion.



**Figure 1.34:** CO emissions concentration values measured in the clean gas from 29 German rotary kilns in 2004

#### 1.3.4.5 Total organic compounds (TOC)

In heat (combustion) processes in general, the occurrence of volatile organic compounds (and carbon monoxide) is often associated with incomplete combustion. In cement kilns, the emissions will be low under normal steady-state conditions, due to the type of kiln used, the large residence time of the gases in the kiln, the high temperature, the nature of the flame (2000 °C) and the excess oxygen conditions. These are process conditions where the organic compounds are decomposed and destroyed with a high efficiency rate (>99.9999 %) [86, EURITS, 2006], [97, CEMBUREAU, 2007]. Concentrations may increase during start-up or abnormal operating (upset) conditions. These events can occur with varying frequency, for example between once or twice per week to once per two or three months.

Emissions of volatile organic compounds (VOCs) can occur in the primary steps of the process (preheater, precalciner), when organic matter that is present in the raw meal, is volatilised as the feed is heated. The organic matter is released between temperatures of 400 and 600 °C. The VOC content of the exhaust gas from cement kilns typically lies between 1 and 80 mg/Nm<sup>3</sup>, measured as TOC, as shown in Figure 1.35. However, in rare cases emissions can reach 120 mg/Nm<sup>3</sup> because of the raw material characteristics. In 2004, example data of TOC emissions were collected from different plants located in several EU-27 and EU-23+ countries (see Glossary). Values from continuous TOC measurements in the clean gas were collected from 120 rotary kilns and the distribution of these measurements were also categorised in thermal substitution as TOC levels, as shown in Figure 1.35 and Figure 1.36. Continuously measured emissions were reported as the annual average of 24 hour averages. Measured values relate to 1 Nm<sup>3</sup> of dry gas under standard conditions [9, CEMBUREAU, 1997 November], [97, CEMBUREAU, 2007]. Continuous measurements from 27 German rotary kilns show examples of carbon emissions concentration values of up to 75 mg/Nm<sup>3</sup>, (yearly average value), as shown in Figure 1.37. The majority of the measurements range below 30 mg/Nm<sup>3</sup> (yearly average value) (detection limit 1.5 – 2.1 mg/Nm<sup>3</sup>) [76, Germany, 2006].

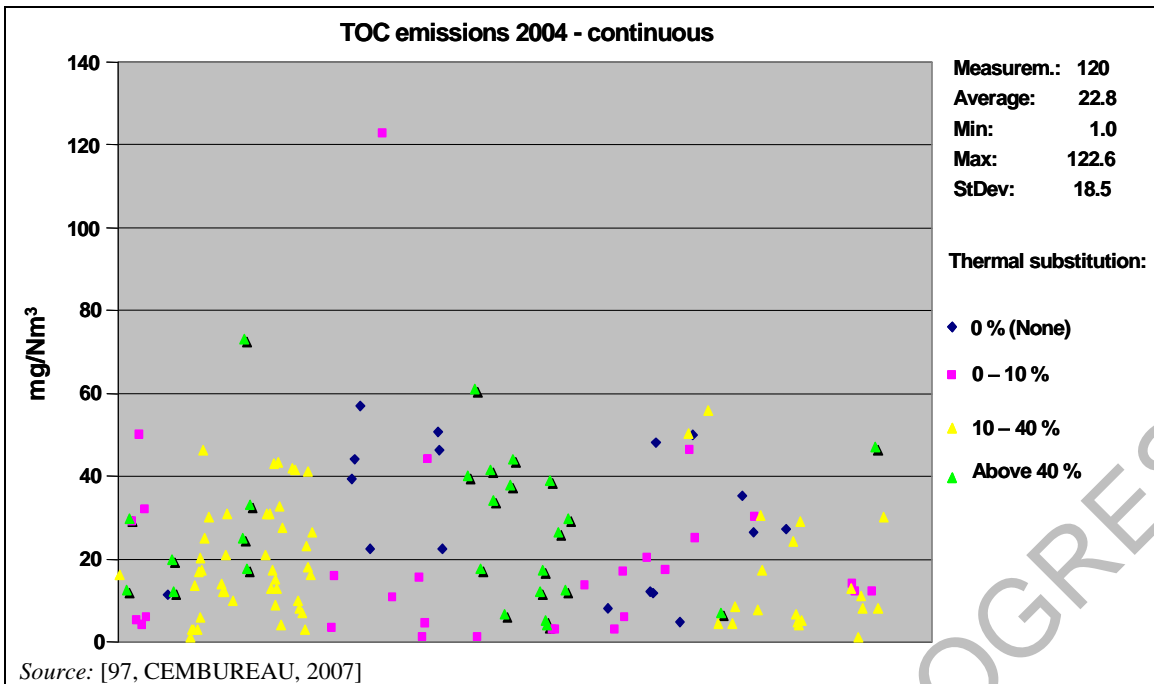


Figure 1.35: TOC emission values from continuous measurements in the clean gas of cement kilns in the EU-27 and EU-23+ countries

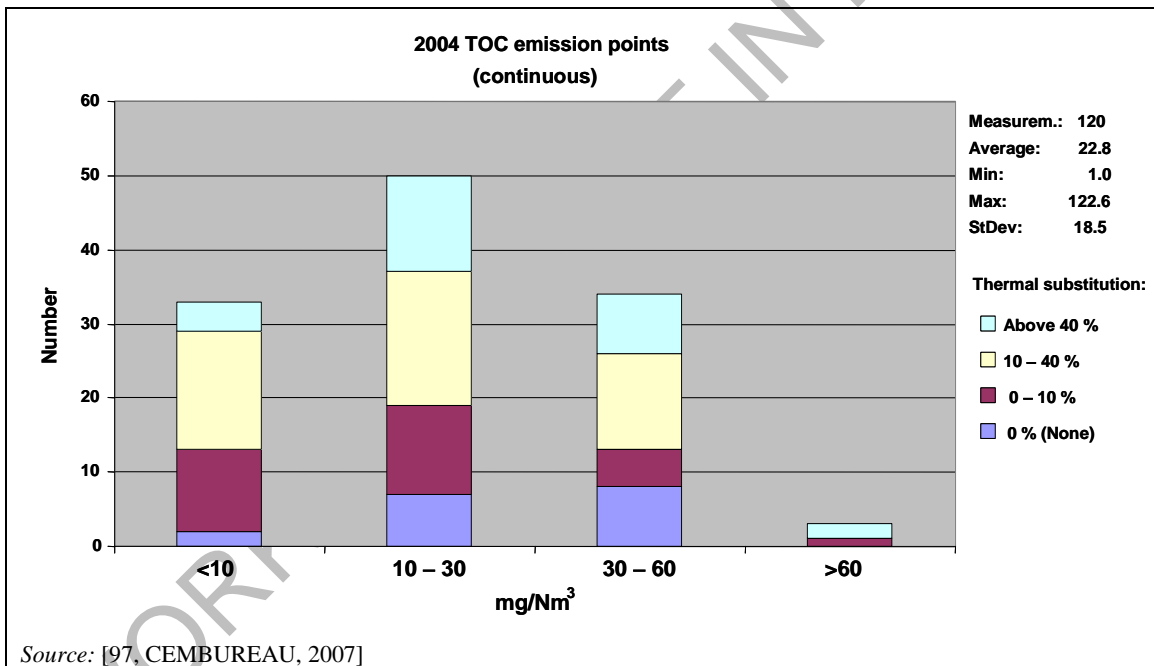
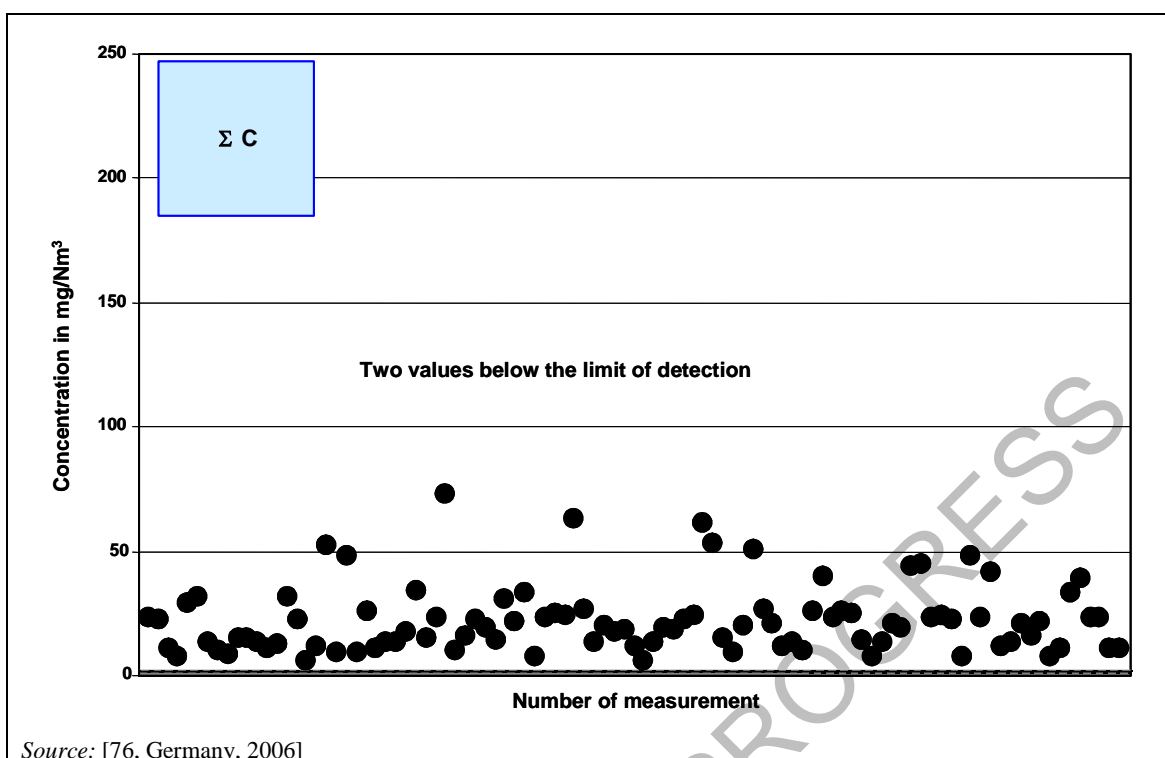


Figure 1.36: Distribution of continuous measurements categorised by the thermal substitution rate of TOC levels





**Figure 1.37:** Total organic carbon emissions concentration values measured in the clean gas from 27 German rotary kilns in 2004

#### 1.3.4.6 Polychlorinated dibenzo-p-dioxins (PCDD) and dibenzofurans (PCDF)

PCDD/F can result from a combination of formation mechanisms, depending on kiln and process design, combustion conditions, feed characteristics and the type and operation of emissions control equipment. Furthermore, any chlorine input in the presence of organic material may potentially cause the formation of PCDD/F in heat (combustion) processes. PCDD/F can be formed in/after the preheater and in the air pollution control device if chlorine and hydrocarbon precursors from the raw materials are available in sufficient quantities (see also Section 1.2.4). However, formation of PCDD/F and their subsequent emissions require the simultaneous presence of five factors:

- hydrocarbons
- chlorides
- a catalyst:
  - some reports suggest that Cu<sup>2+</sup> (and Fe<sup>2+</sup>) have a catalytic effect
- an appropriate temperature window:
  - between 200 and 450 °C with a maximum at 300 – 325 °C
- a long retention time in the appropriate temperature window.

In addition, molecular oxygen has to be present in the gas stream. The formation rate increases with oxygen concentration by a reaction order of 0.5.

As mentioned above, the reformation of PCDD/F is known to occur by de novo synthesis within the temperature window of cooling from 450 to 200 °C. Thus, it is important that, as the gases are leaving the kiln system, they should be cooled rapidly through this range. In practice, this is what occurs in preheater systems as the incoming raw materials are preheated by the kiln gases. Elevated concentrations of PCDD/F in the preheater are not expected because of the increased temperature where PCDD/F are destroyed. At temperatures of about 925 °C PCDD/F are rapidly decomposed. Moreover, destruction is supported by the dynamic process of material

transport to hotter zones while gas is transported to cooler zones. PCDD and PCDF adsorbed to the kiln feed are transported to zones with higher temperatures (400 – 600 °C) where they are thermally destroyed or degraded to lighter homologues. They are released to the gas phase and, in colder zones (200 – 300 °C), they resublime to the kiln feed. Furthermore, due to the long residence time in the kiln and the high temperatures, emissions of PCDD/F are generally low during steady kiln conditions. Detailed investigations and measurements have shown that PCDD/F emissions from the cement industry can be classified as low today, even when wastes and hazardous wastes are used as fuel. The measured data were collected from both wet and dry kilns, performing under different operating conditions, and with using a wide range of wastes and hazardous wastes fed to both the main burner and to the kiln inlet (preheater/precalciner). These investigations have concluded that, in Europe, cement production is rarely a significant source of PCDD/F emissions, because:

- most cement kilns can meet an emission level of 0.1 ng I-TEQ/Nm<sup>3</sup> if primary techniques are applied (see Section 1.4.6)
- the use of wastes as fuels and as raw materials fed to the main burner, kiln inlet or the precalciner do not seem to influence or change the emissions of POPs [88, SINTEF, 2006].

In 2004, example data of PCDD/F emissions were collected from different plants located in EU-27 and EU-23+ countries (see Glossary). Values from PCDD/F measurements in the clean gas were collected as spot measurements, as shown in Figure 1.38 and Figure 1.39. Measured values relate to 1 m<sup>3</sup> of dry gas under standard conditions [97, CEMBUREAU, 2007]. As shown in Figure 1.38, reported data indicate that cement kilns in Europe can mostly comply with an emissions concentration of 0.1 ng I-TEQ/Nm<sup>3</sup>, which is the limit value for waste incineration plants in the **Directive**. German measurements of PCDD/F concentration values measured in the clean gas of 39 rotary kilns (suspension preheater kilns and Lepol kilns) indicate that emissions concentrations are generally well below 0.1 ng I-TEQ/Nm<sup>3</sup> while the average concentration amounts to less than 0.02 ng I-TEQ/Nm<sup>3</sup>, as shown in Figure 1.40. In 26 cases, no PCDD/F emissions were detected. In Spain, PCDD/F measurements were carried out in the period from 2000 to 2003 including 89 measurements from 41 kilns which represent 69.5 % of coverage. These investigations were carried out for different fuels used for the kiln firing process. For those kilns using waste fuels, e.g. refuse derived fuels (RDF), PCDD/F emissions factors range between 0.83 – 133 ng I-TEQ/t<sub>clinker</sub> and are quite comparable with the results obtained for conventional fuel feedings with emissions factor ranges of between 0.67 – 246 ng I-TEQ/t<sub>clinker</sub> [60, VDI 2094 Germany, 2003], [76, Germany, 2006], [86, EURITS, 2006],[88, SINTEF, 2006],[91, CEMBUREAU, 2006], [150, Fabrellas/Larrazabal/Martinez/Sanz/Ruiz/Abad/Rivera, 2004].

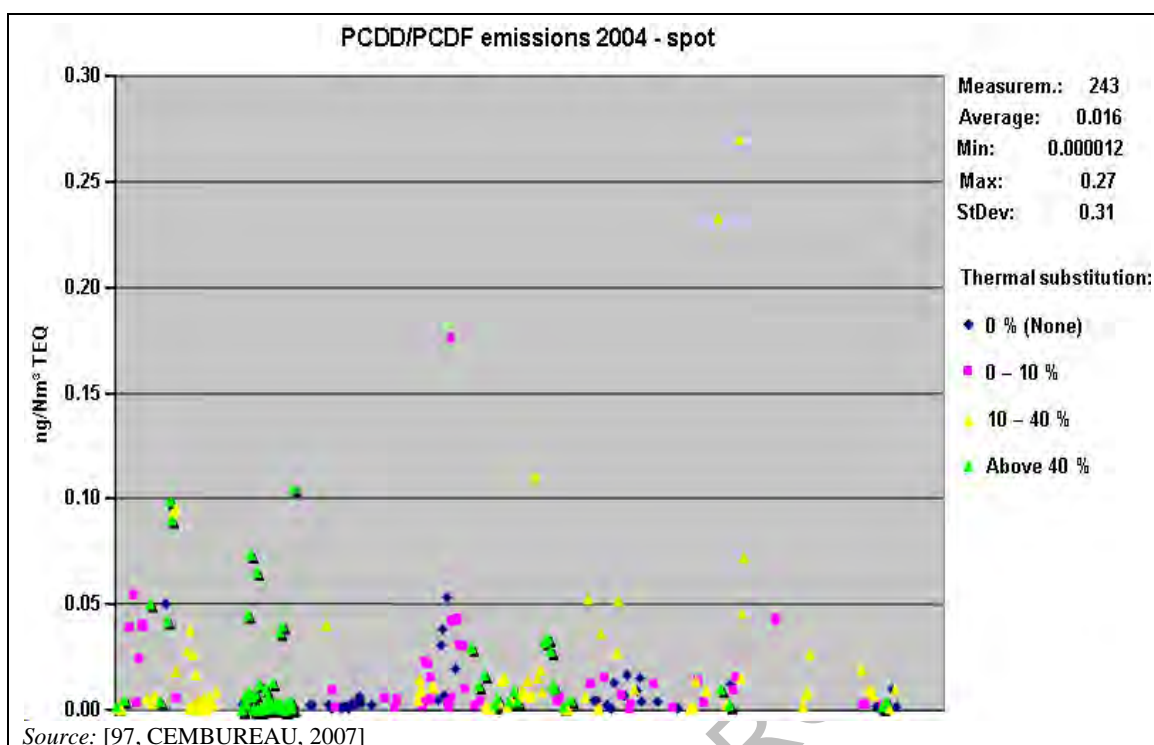


Figure 1.38: Emissions of PCDD/F in the EU-27 and EU-23+ countries in 2004 categorised by thermal substitution rate

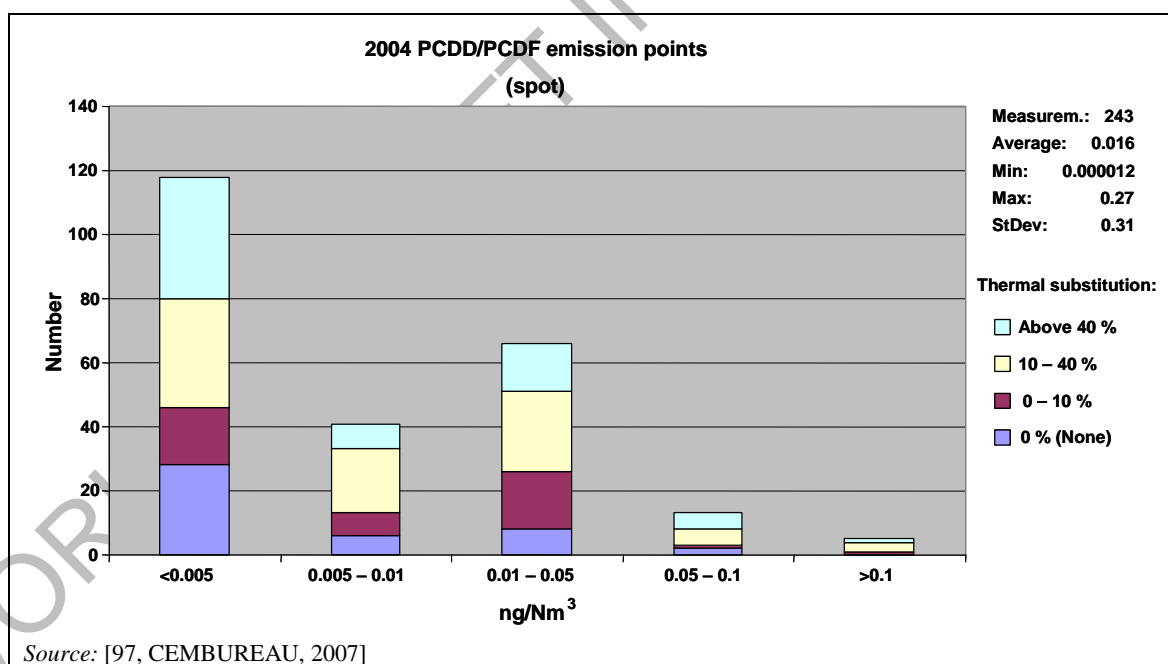


Figure 1.39: Distribution of spot measurements categorised by the thermal substitution rate of PCDD/F levels from cement kilns in the EU-27 and EU-23+ countries

Examples of PCDD/F emissions measured from 39 German rotary kilns are shown in Figure 1.40. This information results from individual measurements carried out three times a year on one particular day. In 26 cases, no PCDD/F emissions were detected. It has to be noted that no detection limit was deducted/subtracted from the standard. For these PCDD/F measurements/samplings, the detection limit was 0.0051 ng I-TEQ/Nm<sup>3</sup>. To evaluate the measurement results, an inter laboratory variation of the method (comparison between different

laboratories) has to be considered [184, CEN standard EN-1948, 2007]. I-TEQ is the abbreviation for international toxicity equivalent [76, Germany, 2006].

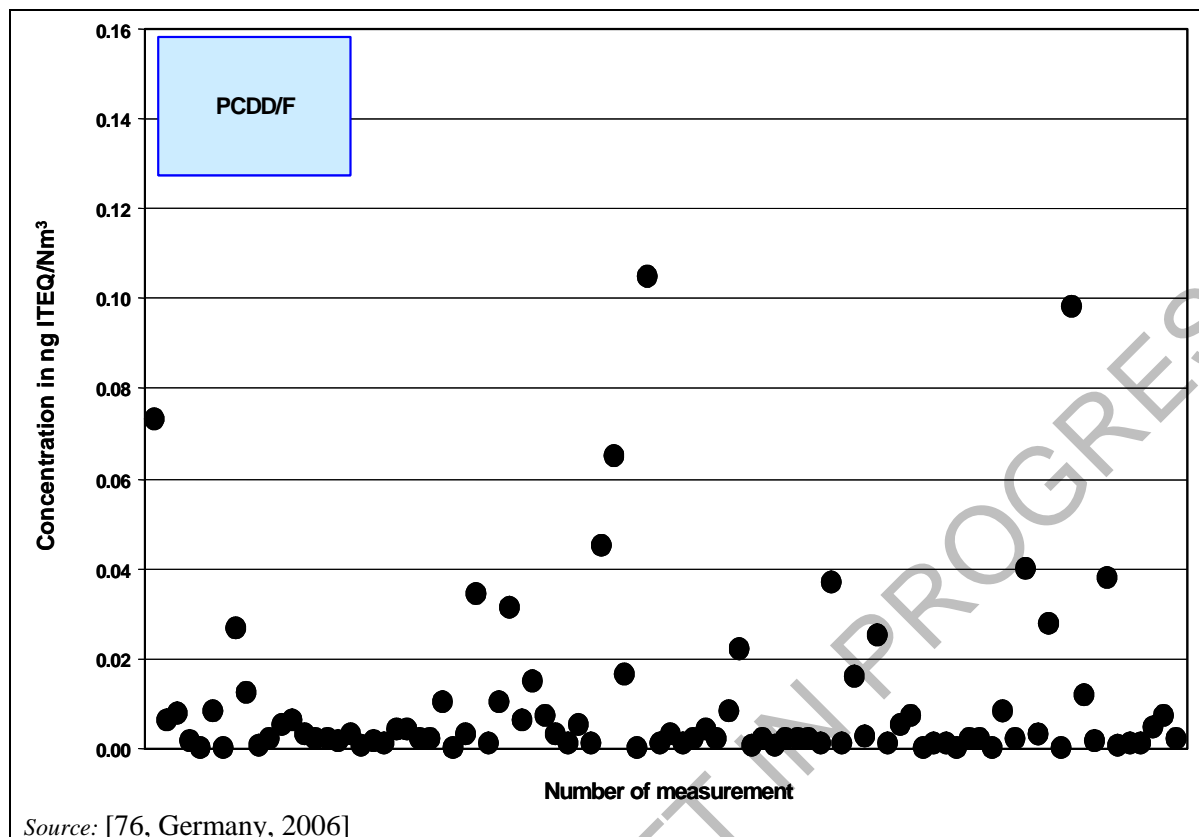


Figure 1.40: Emissions of PCDD/F measured in the clean gas of 39 German rotary kilns in 2004

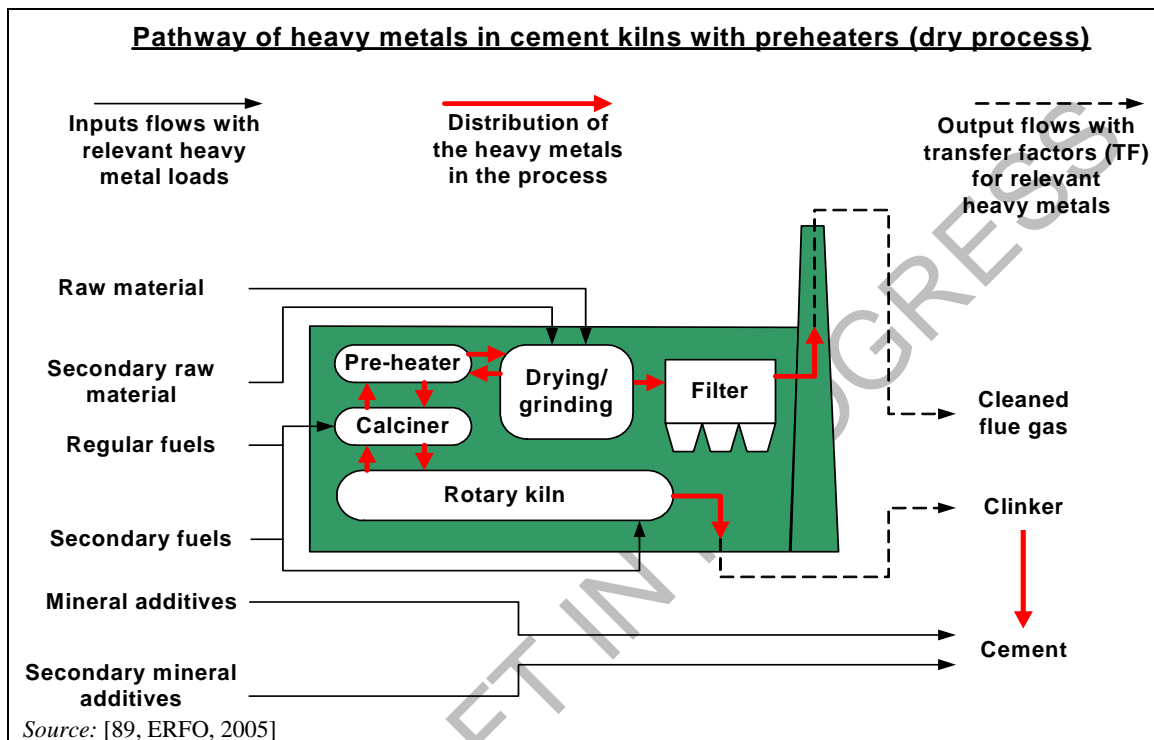
#### 1.3.4.7 Metals and their compounds

Raw materials and fuels will always contain metals. Their concentrations vary widely from one location to another and the potential for emissions to the atmosphere is affected by very complex mechanisms. Furthermore, metal concentrations from wastes used as fuel varies with the waste origin. Metal compounds can be categorised into four classes, based on the volatilities of the metals and their salts:

1. Metals which are or have compounds that are refractory or non-volatile, such as Ba, Be, Cr, As, Ni, V, Al, Ti, Ca, Fe, Mn, Cu and Ag:
  - these metals are completely absorbed by the clinker and discharged with it, and therefore do not circulate in the kiln system. In the exhaust gas, the only emissions are with the dust; they depend only on the input and the efficiency of dust segregation. Consequently, emissions are generally very low.
2. Metals that are or have compounds that are semi-volatile: Sb, Cd, Pb, Se, Zn, K and Na:
  - these metals condense as sulphates or chlorides at temperatures of between 700 and 900 °C; and inner circulation occurs. In this way, the semi-volatile elements which are accumulated in the kiln's preheated system are precipitated again in the cyclone preheater remaining to a high extent but almost completely in the clinker.
3. Thallium: metal that is or has a compound that is volatile:
  - thallium compounds (e.g. TlCl) condense at between 450 and 550 °C, in the case of heat exchanger kilns, in the upper area of the preheater, where they can accumulate (inner circulation).
4. Mercury: metal that is or has a compound that is volatile (see Section 1.3.4.7.1):

- mercury and mercury compounds pass for the most part through the kiln and preheater; they are only partly adsorbed by the raw gas dust, depending on the temperature of the waste gas [12, Netherlands, 1997], [76, Germany, 2006], [91, CEMBUREAU, 2006], [92, Austria, 2006].

The pathway of metals in cement kilns with preheaters in a dry process is shown in Figure 1.41.



**Figure 1.41: Pathway of metals in cement kilns with preheaters in a dry process**

The behaviour and the emission level of the individual metals in the clinker burning process are dependent on the volatility, the input scenario into the kiln, the concentration of the metallic elements in raw materials and fuels, especially when wastes or hazardous wastes are used, the type of process and, most important, the precipitation efficiency of the dust collection systems on the main stack.

Metals introduced into the burning process via the raw materials and fuels may evaporate completely or partially in the hot zones of the preheater and/or rotary kiln depending on their volatility, react with the constituents present in the gas phase, and condense on the kiln feed in the cooler sections of the kiln system. Metals from the fuels initially enter the combustion gases, but are emitted to an extremely small extent only owing to the retention capacity of the kiln and the preheater. As the raw material:fuel mass ratio for clinker production is approximately 10:1, the raw material-related inputs are decisive for the emissions [76, Germany, 2006], [86, EURITS, 2006] [92, Austria, 2006]

Non-volatile metal compounds remain within the process and exit the kiln as part of the cement clinker composition (>99.9 %). Semi-volatile metal compounds are partly taken into the gas phase at sintering temperatures to condense on the raw material in cooler parts of the kiln system. This leads to a cyclic effect within the kiln system (internal cycles), that is either restricted to the kiln and the preheater or is included in the drying grinding unit as well. If the metals are largely condensed in the preheater area, they will be returned to the kiln with the kiln charge. This results in an inner metal cycle (kiln/preheater cycle). This cyclic effect builds up to the point where an equilibrium is established and maintained between input and output via the

cement clinker [9, CEMBUREAU, 1997 November], [60, VDI 2094 Germany, 2003], [76, Germany, 2006].

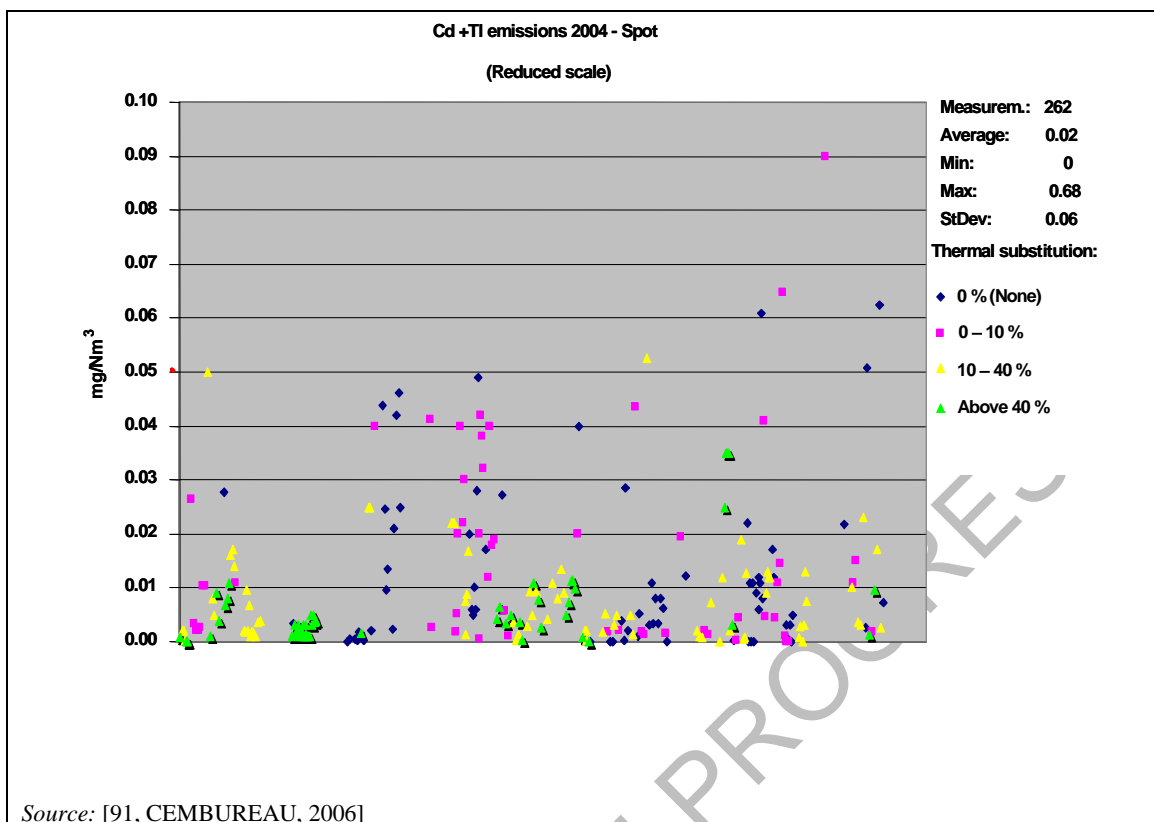
Volatile metal compounds condense on raw material particles at lower temperatures and potentially form internal or external cycles, if not emitted with the flue-gas of the kiln. Thallium and mercury and their compounds are particularly easily volatilised. They are not fully captured in the clinker matrix. Thallium and its compounds condense in the upper zone of the cyclone preheater at temperatures of between 450 and 500 °C. A large part of the thallium brought into the kiln system is therefore retained in the preheater. As a consequence, a cycle can be formed between the preheater, the raw material drying and the exhaust gas purification (internal and external). The emission level of thallium is determined by the concentration level of the external cycle and the collection efficiency of the dust collector. The thallium concentration of, e.g. the ESP dust is a measure for the concentration level of the thallium cycle [60, VDI 2094 Germany, 2003].

Furthermore, but to a lesser extent, cadmium, lead, selenium and their compounds are particularly easily volatilised. An internal cycle of easily volatile metal compounds is formed, when they react with the calcination feedstock or when they precipitate on the feedstock in cool areas of the calcination chamber, in the preheater, or in subsequent drying plants.

Metals form an external cycle when the dust, together with the condensed volatile compounds, is separated in dust separators and returned to the raw meal [27, University of Karlsruhe, 1996].

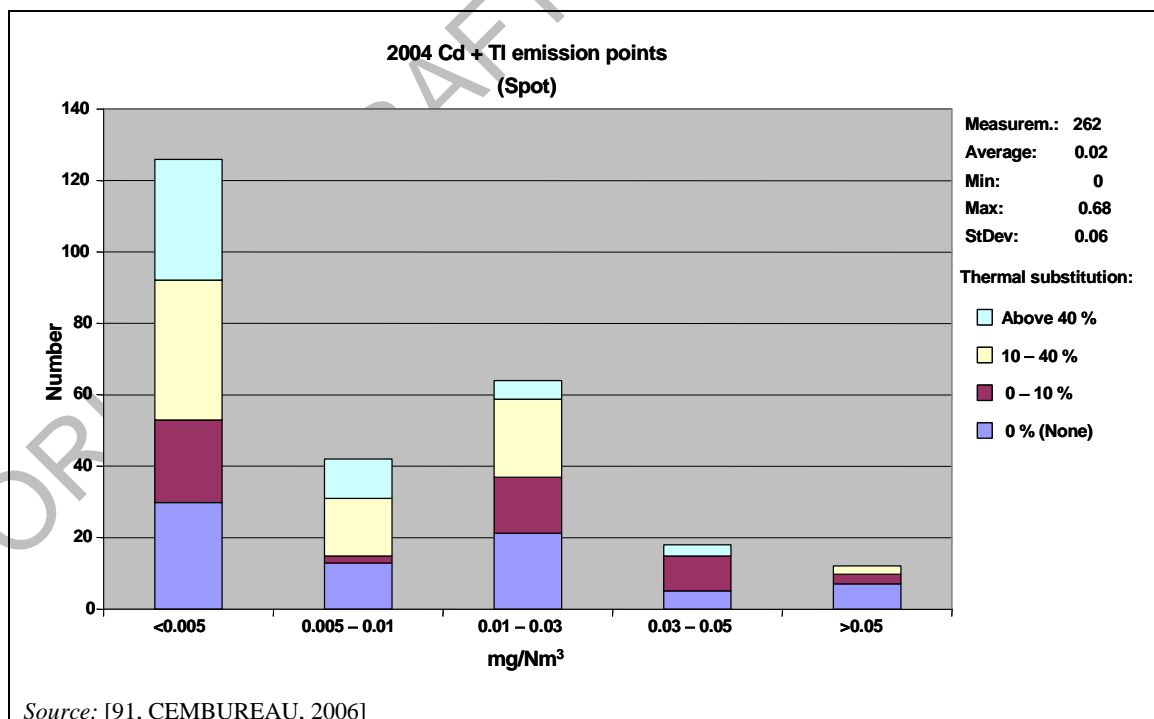
The dusts from the production of cement contain small amounts of metal compounds such as arsenic (As), cadmium (Cd), mercury (Hg), lead (Pb), thallium (Tl) and zinc (Zn). The main source of metal-laden dusts is the kiln system, including preheaters, precalciners, rotary kilns and clinker coolers. The metal concentration depends on the feedstock and recirculation in the kiln system. In particular, the use of coal and waste fuels may increase the input of metals into the process. As the metals entering the kiln system are of varying volatility and because of the high temperature, the hot gases in the cement kiln system also contain gaseous metal compounds. Balance investigations show that there is low retention of elements with high volatility in the clinker, resulting in an accumulation of these substances in the kiln system [27, University of Karlsruhe, 1996].

Cadmium and thallium emissions were collected from 262 spot  $\Sigma$  (Cd, Tl) measurements in the clean gas of rotary kilns, as shown in Figure 1.42 and Figure 1.43. In 2004, these measurements were all taken from different plants located in several EU-27 and EU-23+ countries (see Glossary). The thermal substitution is marked in Figure 1.43 by using different colours. Five measurements are above the scale. Of these, four are of '0' substitution rate and one is '0 – 10'. Emissions vary irrespective of the fuel used. This is due to the fact that cadmium and thallium are not sufficiently volatile to escape with the gas and that they concentrate mainly in the dust and the clinker. Emissions therefore depend on the dedusting device efficiency more than on the fuels [97, CEMBUREAU, 2007].



Source: [91, CEMBUREAU, 2006]

Figure 1.42: Cadmium and thallium emission values from 262 spot  $\Sigma$  (Cd, Tl) measurements in the EU-27 and EU-23+ countries



Source: [91, CEMBUREAU, 2006]

Figure 1.43: Distribution of measurements categorised by the thermal substitution rate of  $\Sigma$  (Cd, Tl) levels

As shown in Figure 1.44 and Figure 1.45, emissions of  $\Sigma$  (Sb, As, Pb, Cr, Co, Cu, Mn, Ni, V) were collected from 287 spot measurements in the clean gas of rotary kilns. In 2004, these measurements were all taken from different plants located in several EU-27 and EU-23+

countries (see Glossary). The thermal substitution is marked in Figure 1.45 by using different colours. Three measurements are above the scale. Of these, one is of '0' substitution rate, one is '0 – 10' and one is '10 – 40'.

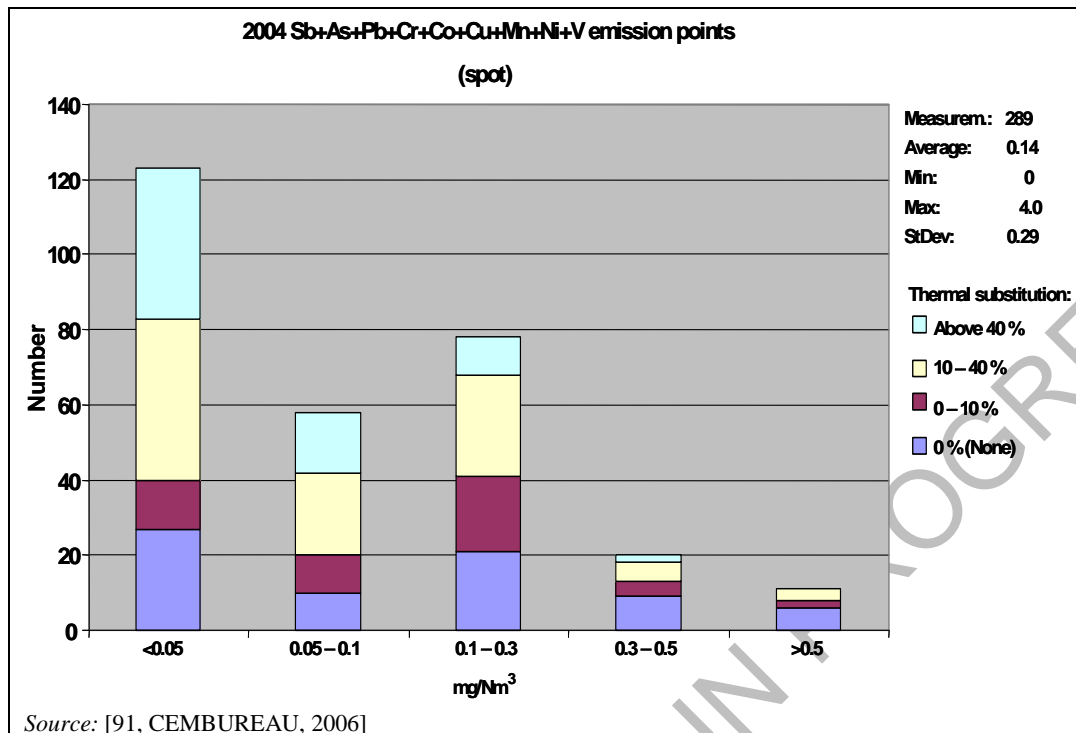


Figure 1.44: Emission values from spot  $\Sigma$  (Sb, As, Pb, Cr, Co, Cu, Mn, Ni, V) measurements in the EU-27 and EU-23+ countries

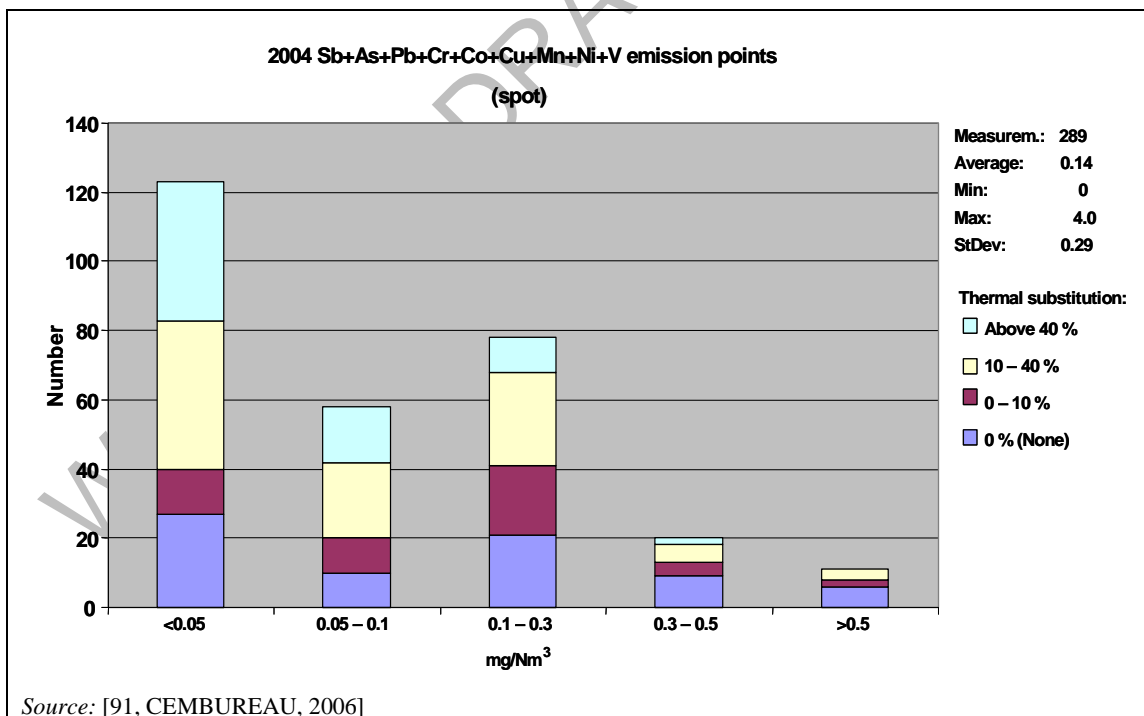


Figure 1.45: Distribution of measurements categorised by the thermal substitution rate of  $\Sigma$  (Sb, As, Pb, Cr, Co, Cu, Mn, Ni, V) levels



Example concentration ranges of different metal components in the clean gas of cement kiln systems' measurements from 1996 to 1998 are shown in Table 1.29.

Component	Concentration <sup>(1)</sup> (mg/Nm <sup>3</sup> )
Antimony	<0.007 – 0.05
Arsenic	<0.007 – 0.025
Beryllium	<0.004
Lead	<0.012 – 0.2
Cadmium	<0.002 – 0.008
Chromium	<0.014 – 0.03
Cobalt	<0.012 – 0.15
Copper	<0.011 – 0.095
Manganese	<0.007 – 2
Nickel	<0.008 – 0.075
Mercury	<0.005 – 0.12
Selenium	<0.008 – 0.02
Tellurium	<0.0017 – 0.015
Thallium	<0.005 – 0.03
Vanadium	<0.007 – 0.075
Zinc	<0.1 – 0.45
Tin	<0.01 – 0.025
<sup>(1)</sup> Concentration is related to standard temperature and pressure conditions after reduction of water vapour content; total of particle-borne and filter passing fractions; results from single measurements averaged over the sampling period <i>Source:</i> [60, VDI 2094 Germany, 2003]	

**Table 1.29: Ranges of heavy metal concentrations in the clean gas of cement kiln systems' measurements from 1996 to 1998**

#### 1.3.4.7.1 Mercury

Mercury and its compounds are particularly easily volatilised (highly volatile metal). It is a toxic metallic element and pollution of mercury is understood to be global, diffuse and chronic, so atmospheric emissions from plants have to be reduced. Therefore, to control mercury emissions, it can be necessary to limit mercury input into the kiln system (see Sections 1.2.4.3.2, 1.2.4.3.2.1 and 1.3.4.13). Mercury and its compounds are not completely precipitated and retained in the kiln system and/or the preheater and therefore, they are not captured in the clinker. They are precipitated on the exhaust gas route due to the cooling of the gas and are partially adsorbed by the raw material particles, depending on the temperature of the waste gas. This portion is precipitated in the kiln exhaust gas filter. Therefore, mercury may only become enriched in the external cycle, where the concentration level and the emissions are mainly determined by the exhaust gas conditions. To prevent a long-cycle increase in mercury emissions, it may become necessary to limit the concentration of the external cycle, e.g. by continuously or intermittently extracting part of the dust collected in the filter system. Furthermore, precipitation and hence, mercury removal increases with decreasing exhaust gas temperature. Indications from measurements performed on cyclone preheater kiln systems show that more than 90 % of mercury exists on particles which are formed at exhaust gas temperatures of below 130 °C. Mercury compounds are then completely removed from the dust collector of the kiln system. Due to the high collection efficiency of the dust collector, mercury concentrations in the clean gas of rotary kiln systems are often below the detection limit (see Figure 1.46 and Figure 1.47).

The dust from the dust collector can be recirculated back to the cement mill. In the case of the use of waste fuels, the mercury input to the kiln can be limited regularly (see Sections 1.2.4.3.2.1 and 6.2.2.1.1). Another possibility to reduce mercury emissions is to reduce the off-

gas temperature after the conditioning tower to improve the precipitation of mercury and its compounds during dust filtration. Furthermore, in one German plant, activated carbon is injected as an adsorbent to the flue-gas [12, Netherlands, 1997], [76, Germany, 2006], [86, EURITS, 2006], [91, CEMBUREAU, 2006], [92, Austria, 2006], [168, TWG CLM, 2007].

As shown in Figure 1.46 and Figure 1.47, mercury emissions were collected from 306 spot Hg measurements in the clean gas of rotary kilns. In 2004, these measurements were all taken from different plants located in several EU-27 and EU-23+ countries (see Glossary). The thermal substitution is marked in Figure 1.47 by using different colours. Six measurements are above the scale. Of these, one is of '0' substitution rate, one is '0 – 10', two are '10 – 20' and two measurements are 'above 40'. As explained, mercury is the most volatile heavy metal and has a poor trapping coefficient. Waste fuels undergo a rigorous acceptance and inspection procedure before being used [97, CEMBUREAU, 2007].

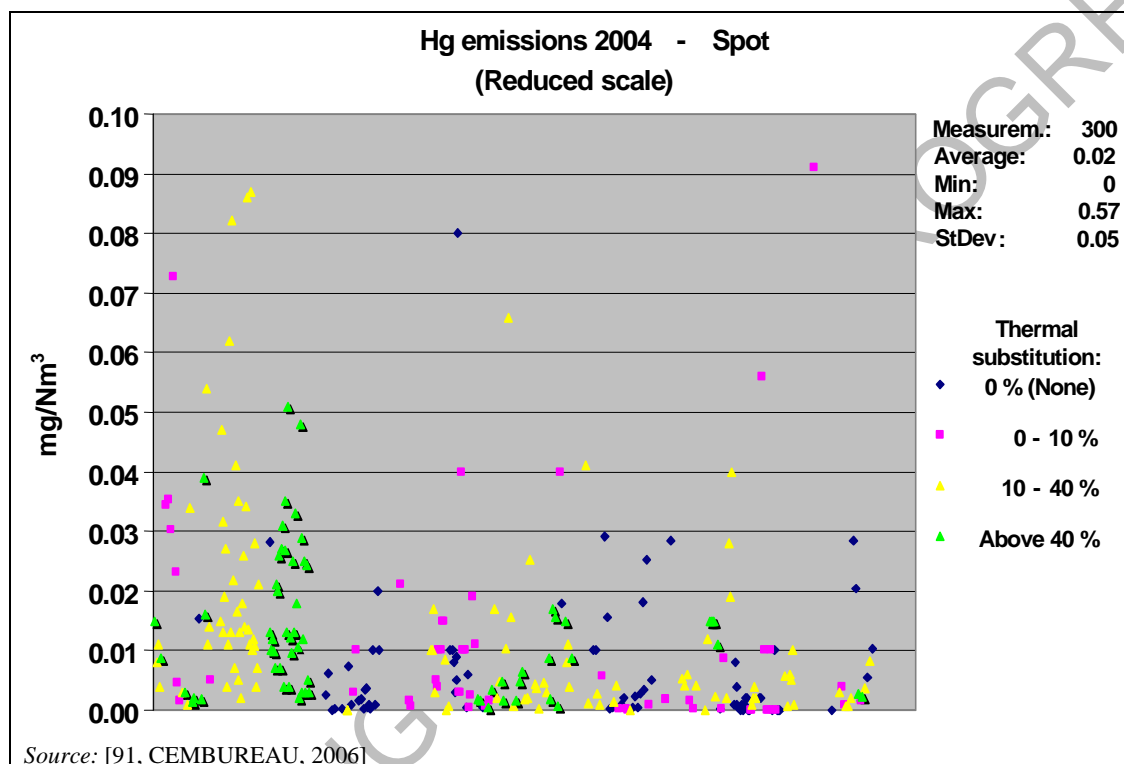


Figure 1.46: Mercury emission values from 306 spot Hg measurements in the EU-27 and EU-23+ countries

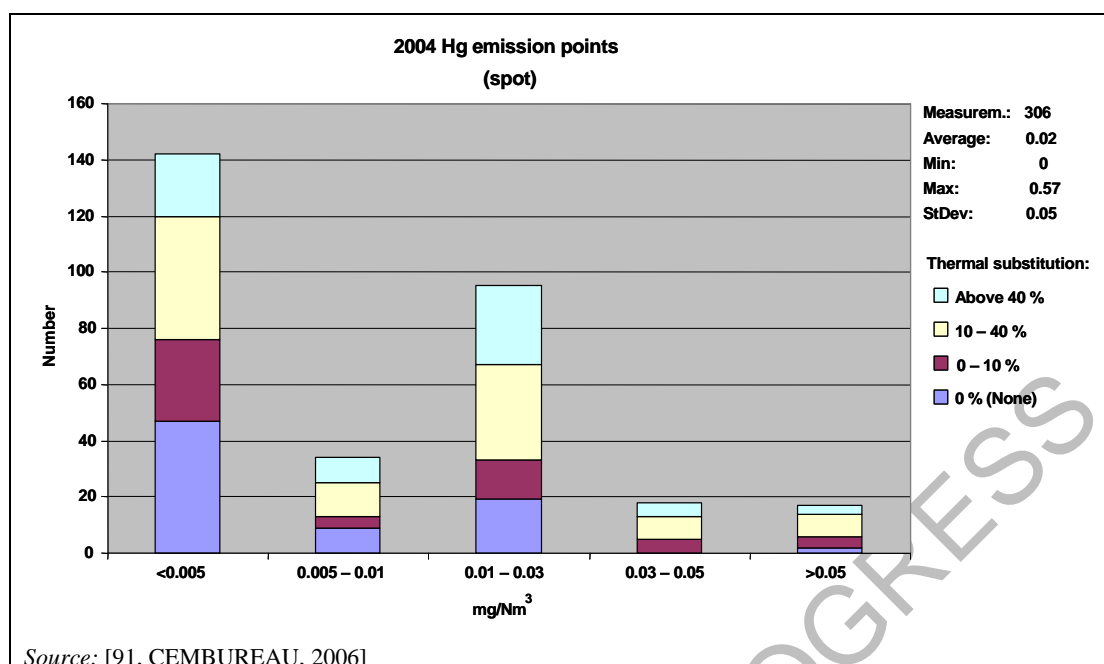


Figure 1.47: Mercury emission values from 306 spot Hg measurements in the EU-27 and EU-23+ countries

### 1.3.4.8 Hydrogen chloride and hydrogen fluoride (HCl and HF)

Chlorides and fluorides are minor additional constituents. They may enter into the kiln system with the different inputs as raw materials and/or fuels. Carrying out regular periodic monitoring is appropriate for these substances.

#### 1.3.4.8.1 Gaseous inorganic chlorine compounds

Chlorine compounds are minor additional constituents contained in the raw materials and fuels of the clinker burning process. They may enter into the kiln system with the different inputs and during the firing process in the kiln system; they react with the alkalis of the kiln charge to form alkali chlorides. These compounds, which are initially vaporous, condense on the kiln feed or the kiln dust, at temperatures of between 700 and 900 °C, subsequently re-enter the rotary kiln system and evaporate again. They show a cycling behaviour and may become enriched in the area between the rotary kiln and the preheater. A bypass at the kiln inlet allows the effective reduction of alkali chloride cycles and thus diminishes operational malfunctions. From a chloride input of 0.2 g Cl/kg clinker, depending on the specific plant, a branch stream of the kiln exhaust gases is diverted through a bypass and cooled to forestall accretions in the preheater bottom section. As the gas stream is being cooled, the gaseous alkali chloride compounds condense on the kiln dust particles and can then be removed from the system via a dust collector. The collected bypass dust is returned under controlled conditions to the cement mill feed stream.

As shown in Figure 1.48, during the clinker process, gaseous inorganic chlorine compounds are either not emitted at all or only available in very small quantities from European cement plants. Gaseous inorganic chlorides detected in the exhaust gas of rotary kiln systems are generally attributable to the ultrafine grain size fractions of alkali chlorides in the clean gas dust [60, VDI 2094 Germany, 2003], [76, Germany, 2006], [86, EURITS, 2006], [97, CEMBUREAU, 2007].

In 2004, example data of continuous HCl emissions measurements and spot measurements were collected from plants located in several EU-27 and EU-23+ countries (see Glossary). Values from continuous HCl measurements in the clean gas were collected from 98 rotary kilns as well

as values from 233 spot measurements, as shown in Figure 1.48 and Figure 1.50. Figure 1.49 and Figure 1.51 show the emissions distribution of the continuous HCl measurements and the spot measurements. Continuously measured emissions were reported as the annual average of 24 hour averages. Measured values relate to 1 Nm<sup>3</sup> of dry gas under standard conditions [97, CEMBUREAU, 2007]. Furthermore, Figure 1.52 shows emissions examples in a range of between 0 – 8 mg/Nm<sup>3</sup> (yearly average value), while 91 values are below the detection limit and one is above 15 mg/Nm<sup>3</sup>, measured from 39 German rotary kilns [76, Germany, 2006].

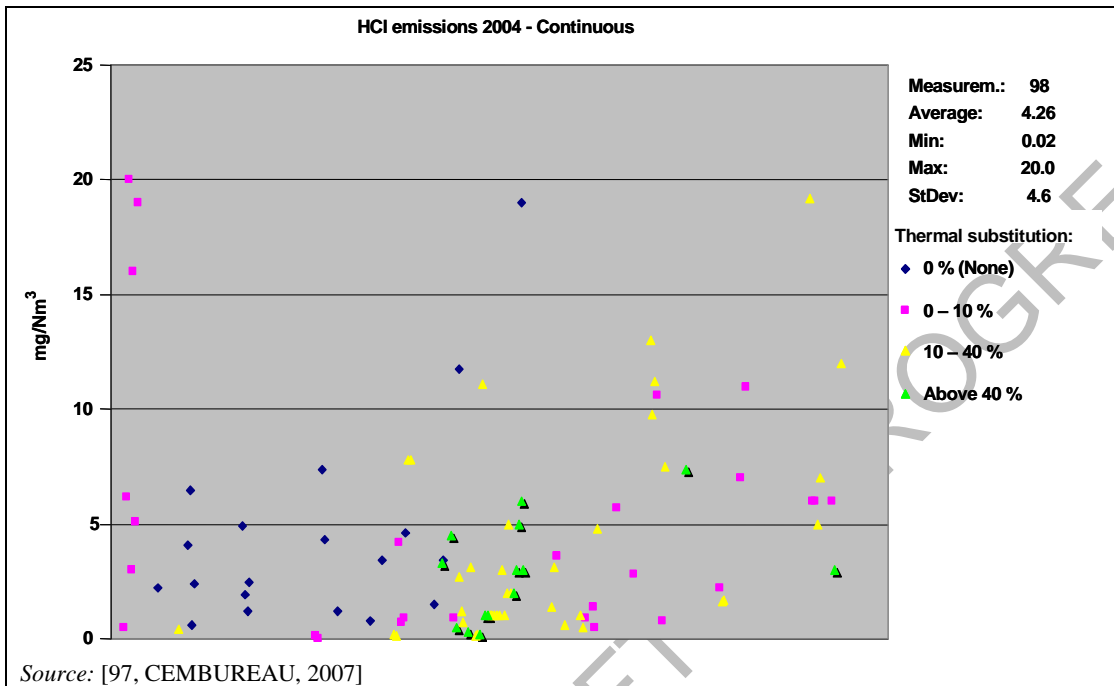


Figure 1.48: HCl emission values from continuous HCl measurement in the clean gas from 98 cement kilns in the EU-27 and EU-23+ countries

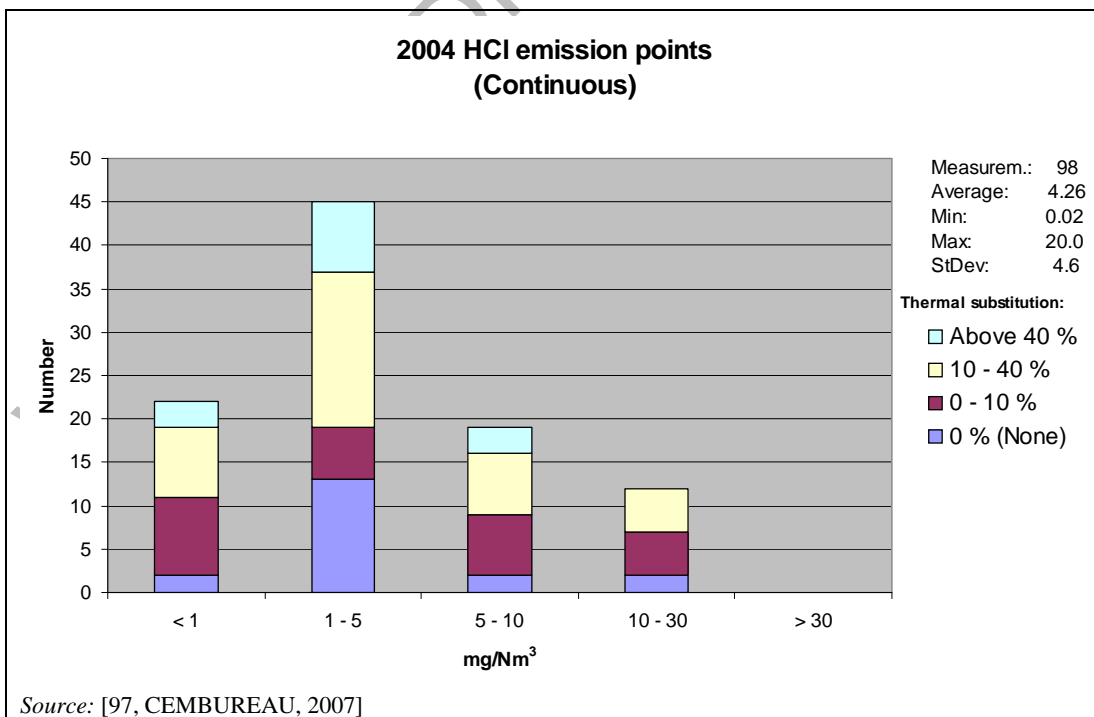
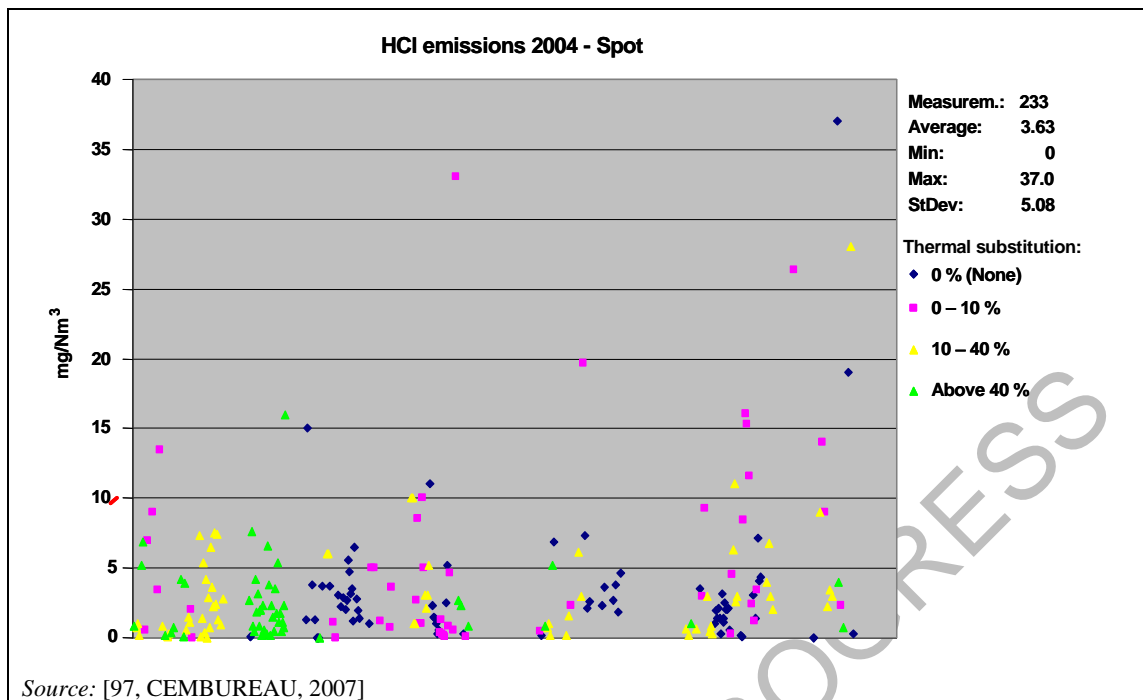
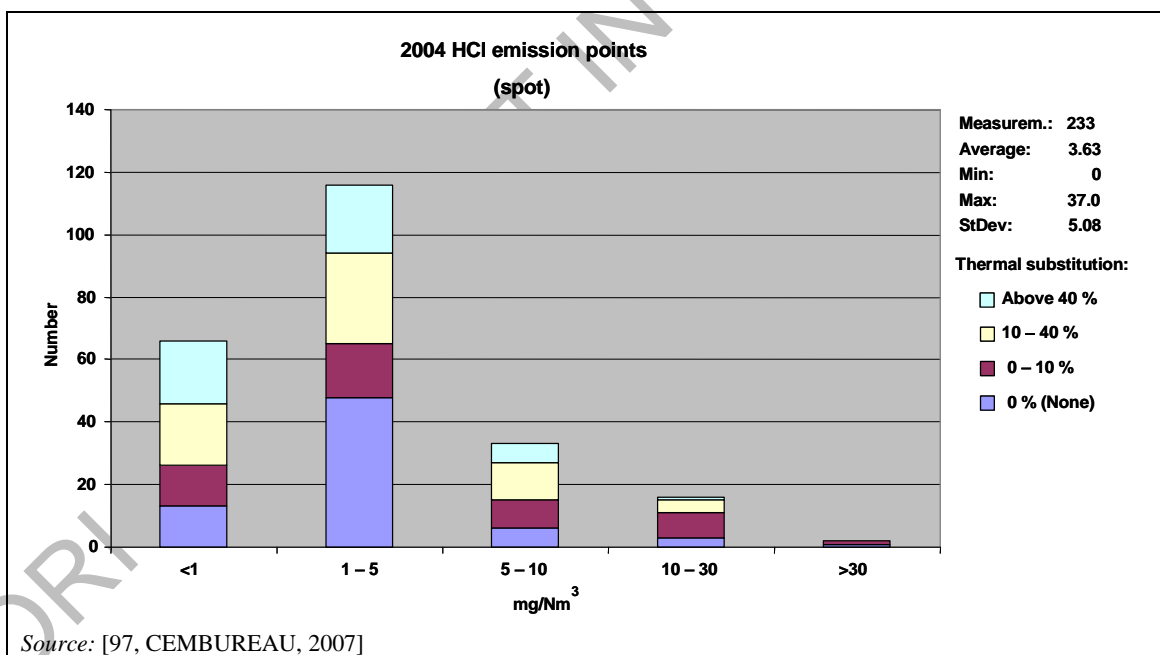


Figure 1.49: Distribution of continuous HCl measurements categorised by the thermal substitution rate

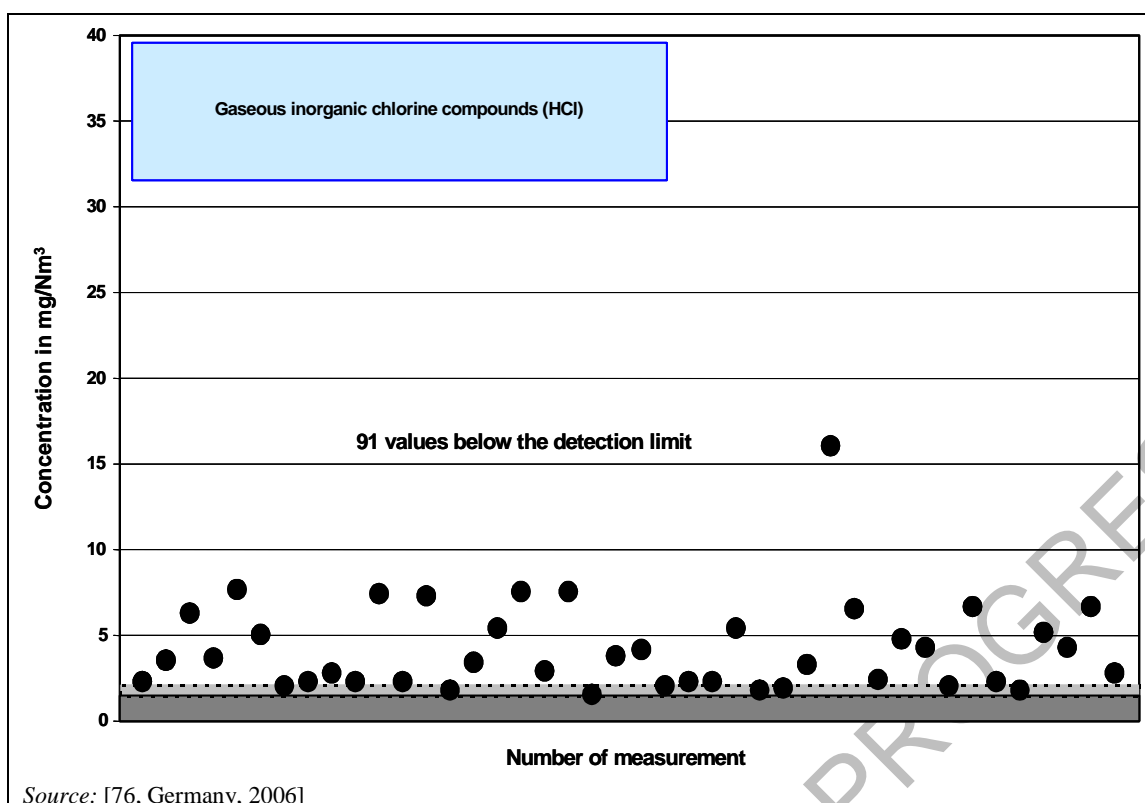


**Figure 1.50:** Emission values from 233 spot measurements in the clean gas of rotary kilns in the EU-27 and EU-23+ countries



**Figure 1.51:** Distribution of HCl spot measurements categorised by the thermal substitution rate of HCl levels

Examples of HCl emissions measured from 38 German rotary kilns are shown in Figure 1.52. This information results from individual measurements carried out three times a year on one particular day. In 91 cases, the emission value was below the detection limit of between 1.5 – 2.1 mg/Nm<sup>3</sup>.



Source: [76, Germany, 2006]

**Figure 1.52:** Emissions of gaseous inorganic chlorine compounds, stated as HCl, measured in the clean gas from 38 German rotary kilns in 2004

#### 1.3.4.8.2 Gaseous inorganic fluorine compounds

Of the fluorine present in rotary kilns, 90 to 95 % is captured in the clinker, and the remainder is bound with dust in the form of calcium fluoride ( $\text{CaF}_2$ ) which is stable under the conditions of the burning process. Owing to the great excess of calcium, the emissions of gaseous fluorine compounds and of hydrogen fluoride in particular, are virtually excluded. Ultrafine dust fractions that pass through the measuring gas filter may simulate low contents of gaseous fluorine compounds in rotary kiln systems. Minor amounts of fluorides are discharged with the kiln dust, such as in the form of  $\text{CaF}_2$ .

In 2004, example data of continuous HF emissions measurements and spot measurements were collected from different plants located in the EU-27 and the EU-23+ countries (see Glossary). Values from continuous HF measurements in the clean gas were collected from 28 rotary kilns as well as values from 210 spot measurements, as shown in Figure 1.53 and Figure 1.55. Five measurements are above the scale. Out of these, four are of zero substitution rate and one is above 40. Figure 1.54 and Figure 1.56 show the emissions distribution of the continuous HF measurements and the HF spot measurements. Continuously measured emissions were reported as the annual average of 24 hour averages. Measured values relate to  $1 \text{ Nm}^3$  of dry gas under standard conditions. Fluorides from cement kiln systems are below  $1 \text{ mg/Nm}^3$ , expressed as HF [76, Germany, 2006], [86, EURITS, 2006], [97, CEMBUREAU, 2007].

Furthermore, Figure 1.57 shows examples of HF emissions in a range of between  $0.005 - 0.35 \text{ mg/Nm}^3$ , and 106 values are below the detection limit, measured from 38 German rotary kilns. This information results from individual measurements carried out three times a year on one particular day. The detection limit is between  $0.04$  and  $0.06 \text{ mg/Nm}^3$  [76, Germany, 2006], [103, CEMBUREAU, 2006].

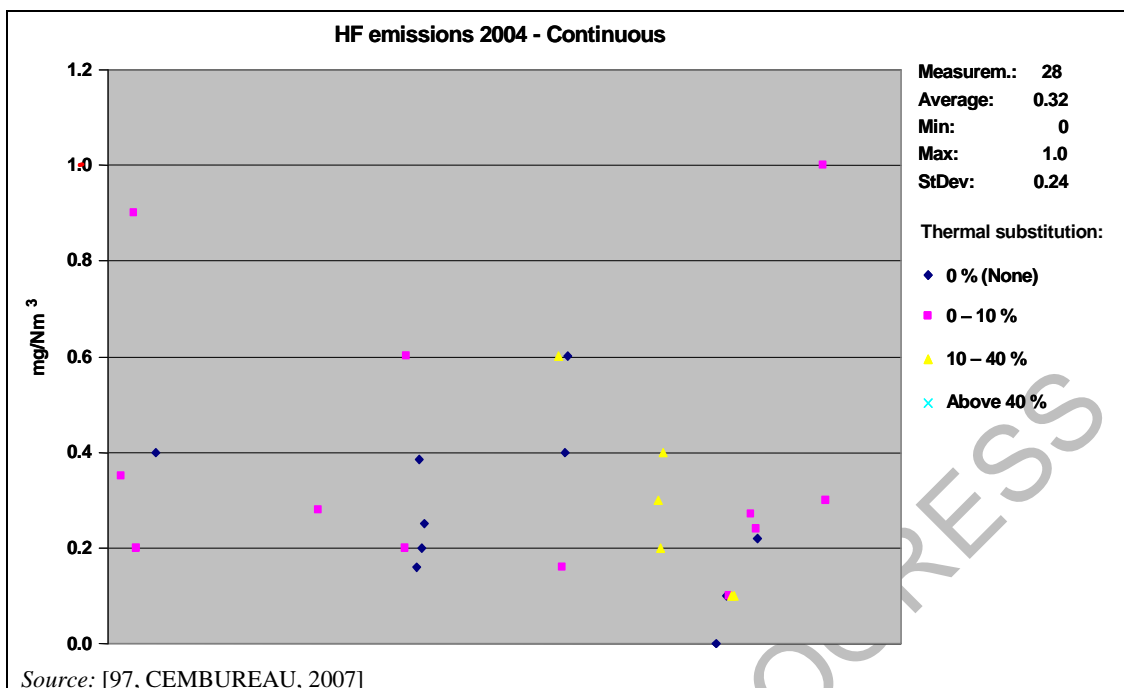


Figure 1.53: Emission values from continuous HF emissions measurement in the clean gas from rotary kilns in the EU-27 and EU-23+countries

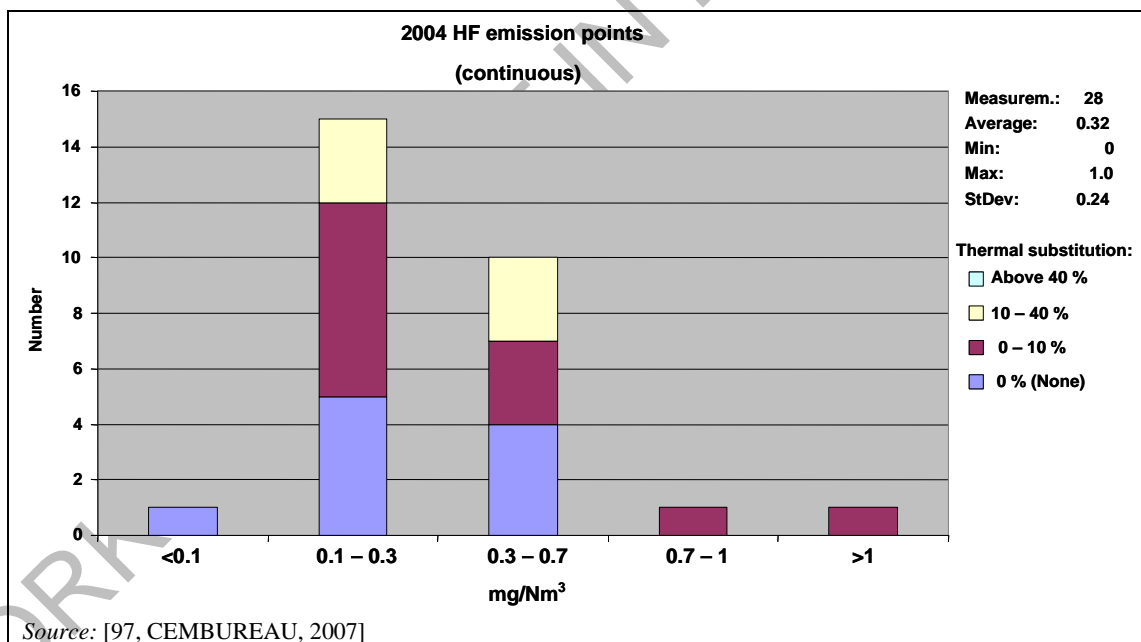


Figure 1.54: Distribution of continuous HF emissions measurements categorised by the thermal substitution rate of HF levels

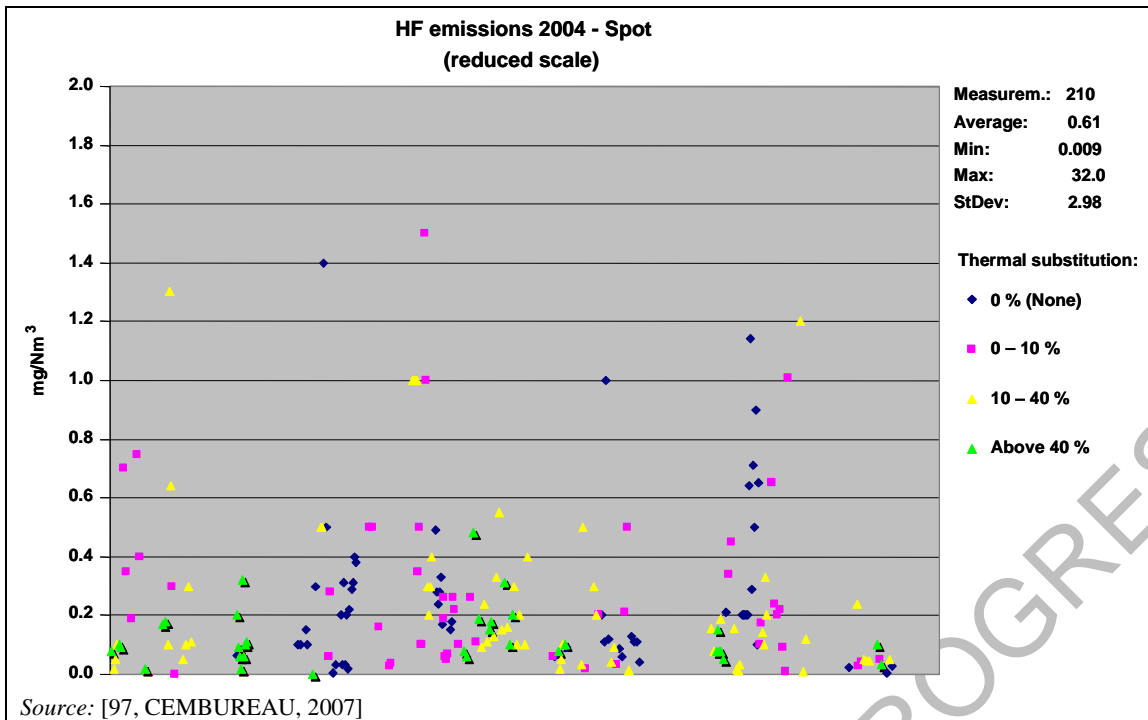


Figure 1.55: Emission values from spot HF measurements in the clean gas of rotary kilns in the EU-27 and EU-23+ countries

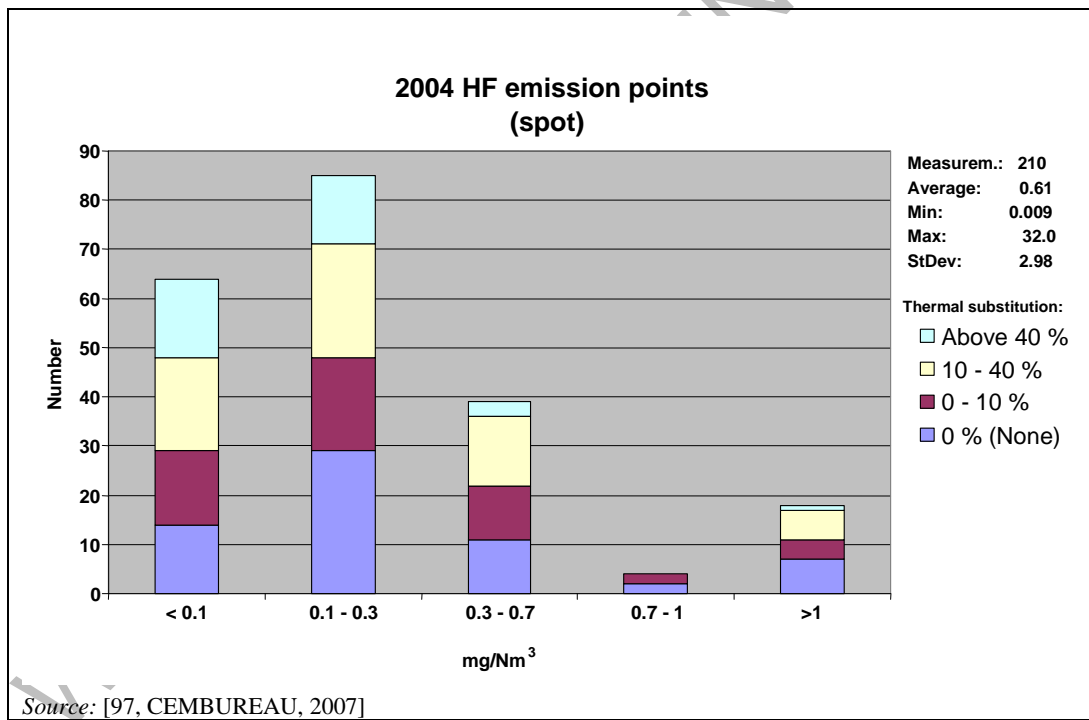
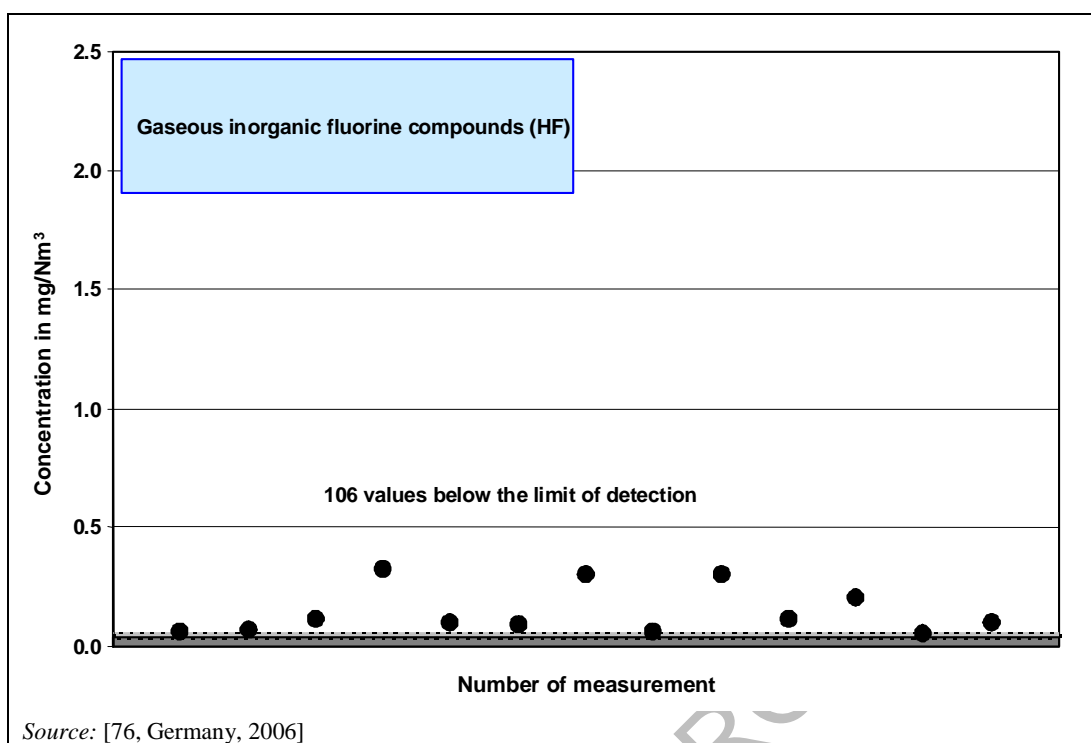


Figure 1.56: Distribution of HF spot measurements categorised by the thermal substitution rate of HF levels





Source: [76, Germany, 2006]

**Figure 1.57:** Emissions of gaseous inorganic fluorine compounds, stated as HF, measured in the clean gas from 38 German rotary kilns in 2004

#### 1.3.4.9 Ammonia (NH<sub>3</sub>)

Emissions of NH<sub>3</sub> occur in the primary steps of the process from the raw materials. The NH<sub>3</sub> content of the exhaust gas from cement kilns can reach as much as 200 mg/Nm<sup>3</sup>. Additional NH<sub>3</sub> can occur from abatement techniques, such as the selective non-catalytic reduction (SNCR) technique, where also variable emissions of unreacted ammonia may occur (ammonia slip). A regular monitoring of NH<sub>3</sub> emissions is essential.

Investigations from two plants in Sweden from 1994 to 2006 (initial trials for testing ammonia emissions) show that NH<sub>3</sub> emissions arising from the raw material are in a range of between 10 – 35 mg/Nm<sup>3</sup>. Furthermore since 1998, one of these plants has been equipped with a SO<sub>x</sub> scrubber which buffers the ammonia in the scrubber liquor and equalises peaks and lows. From the stack of this scrubber, the ammonia emissions have been measured continuously since 1998 as shown in Figure 1.58. Since the scrubber has been in operation, the short term peaks are higher up to 125 mg/Nm<sup>3</sup>. This is happening due to the increased scrubber liquor from 53 to 59 °C and the shifted equilibrium so that some accumulated ammonia is released again. However, these plants are equipped with milling systems (raw and coal mill) from where ammonia also is adsorbed and only a small amount of ammonia is transported to the cement mill facilities together with the gypsum (3 kg/h). The cement mill operates at low temperatures in a closed circuit and only very occasionally was the ammonia smell detected from the cement silo.

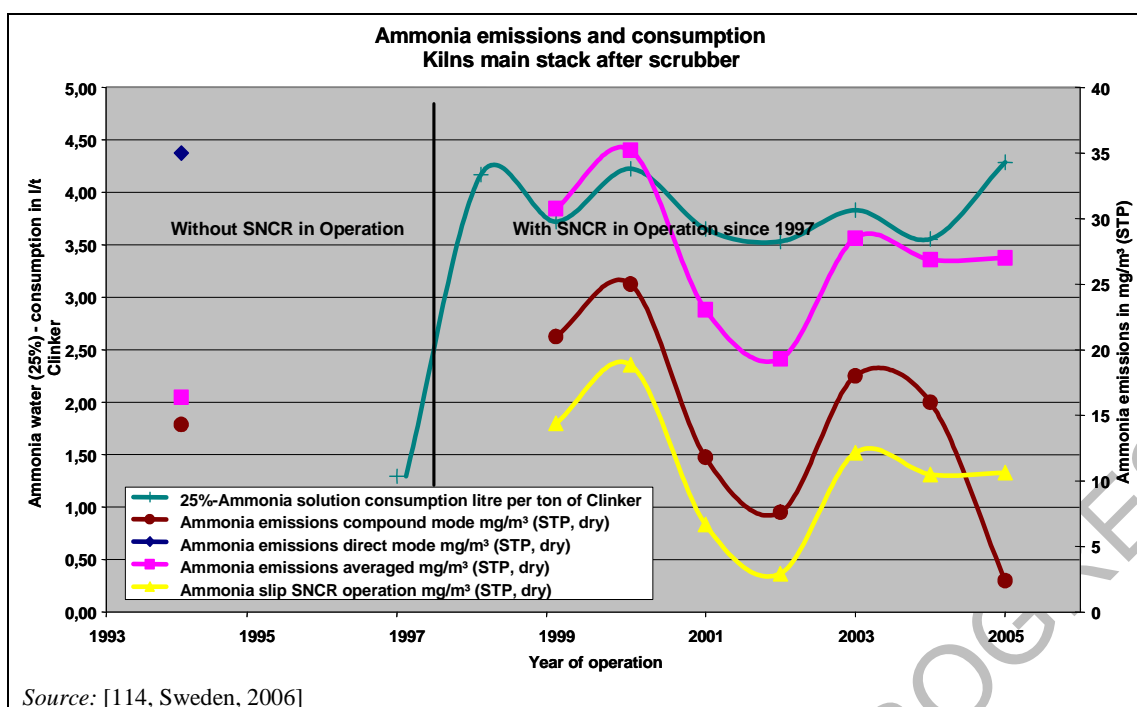


Figure 1.58: Ammonia emissions from a Swedish cement plant equipped with a  $\text{SO}_x$  scrubber

In 2007, at one German cement plant which is equipped with the high efficiency SNCR technique, investigations and trials were carried out within a period of six months.  $\text{NO}_x$  emission levels of 350 and 200  $\text{mg}/\text{Nm}^3$  (daily average value) were achieved by applying corresponding  $\text{NH}_3$ : $\text{NO}$  molar ratios of 0.7 – 0.8 and 1.4 – 1.5. However, for achieving the lower  $\text{NO}_x$  emission level, the  $\text{NH}_3$  measurements resulted in significant ammonia slip of between 50 – 200  $\text{mg}/\text{Nm}^3$  particularly during mill-off operation. The ammonia slip was twice as high to achieve the emission level of 200  $\text{mg}/\text{Nm}^3$  ( $\text{NH}_3$ : three months average value of 11  $\text{mg}/\text{Nm}^3$ ) compared to a level of 350  $\text{mg}/\text{Nm}^3$  ( $\text{NH}_3$ : three months average value of 21  $\text{mg}/\text{Nm}^3$ ) (see also Section 6.2.4.2) [160, Germany, 2007], [173, Germany, 2007], [182, TWG CLM, 2008].

Furthermore, investigations at an Irish cement plant in 2004 by carrying out short term SNCR trials showed  $\text{NH}_3$  concentrations in a range of between 4 and 26  $\text{mg}/\text{Nm}^3$  in the raw gas after the preheater of the kiln. These concentrations have been measured by testing two injection configurations (standard conditions;  $\text{NH}_3$ : $\text{NO}$  molar ratio of one (1) with a  $\text{NO}_x$  reduction rate of 50 %). The  $\text{NH}_3$  slip sets limits to the overstoichiometric addition of a reducing agent. Carrying out regular periodic monitoring is appropriate for this substance [76, Germany, 2006], [103, CEMBUREAU, 2006], [114, Sweden, 2006] [123, Ireland, 2005] [168, TWG CLM, 2007], [173, Germany, 2007].

An example from a German plant equipped with the SCR technique led to  $\text{NH}_3$  slip to below 1  $\text{mg}/\text{Nm}^3$  [173, Germany, 2007].

It has to be noted that  $\text{NH}_3$  in the raw material also serves as the reducing agent (see Section 6.2.5) [76, Germany, 2006], [168, TWG CLM, 2007].

### 1.3.4.10 Benzene, toluene, ethylbenzene and xylene (BTEX)

Measurements of these substances may be required occasionally under special operating conditions.

In some German plants, additional individual measurements of benzene have been carried out since 2004 which range between 0.02 and 3.6 mg/Nm<sup>3</sup>. Benzene emissions in low concentrations are caused by the small quantities of organic constituents input via the natural raw materials (remnants of organisms and plants incorporated in rock in the course of geological history) during kiln feed preheating. Examples of measured emissions concentrations of benzene in German kilns are shown in Figure 1.59 (based on a detection limit of 0.013 mg/Nm<sup>3</sup>). The benzene emissions were not dependent on the fuels used.

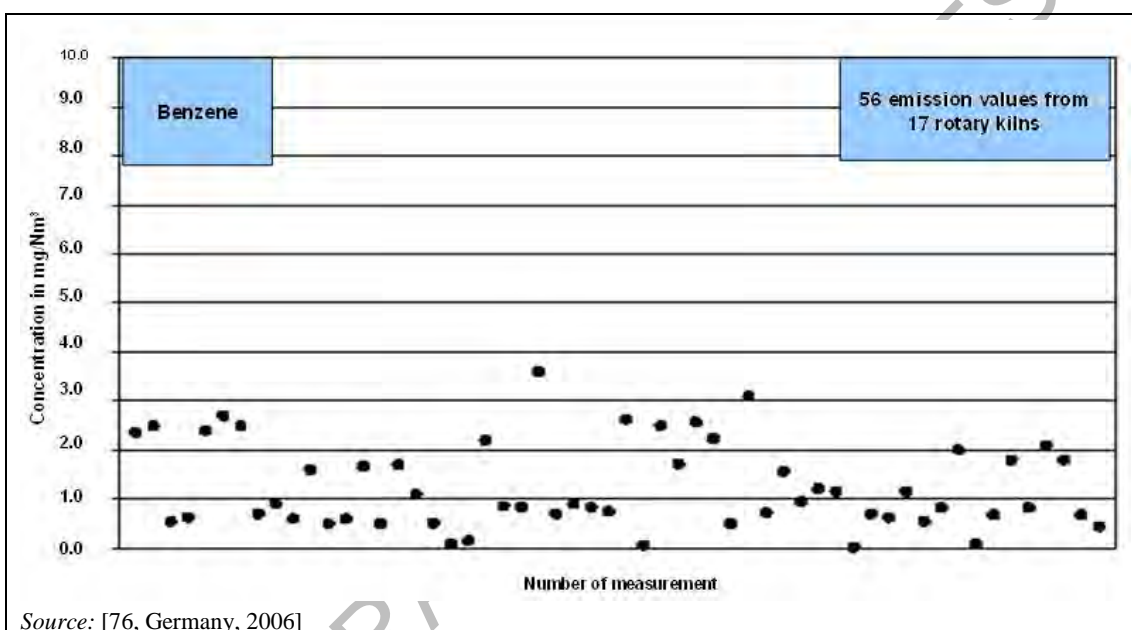


Figure 1.59: Benzene emissions concentrations measured from 17 German rotary kilns

### 1.3.4.11 Polyaromatic hydrocarbons (PAH)

Measurements of these substances may be required occasionally under special operating conditions.

### 1.3.4.12 Other organic pollutants

Other organic pollutants occurring from the cement manufacturing process are, for example, chlorobenzenes, PCB (polychlorinated biphenyls) including coplanar congeners, and chloronaphthalenes.

Measurements of these substances may be required occasionally under special operating conditions.

**1.3.4.13 Impacts on emissions behaviour and energy efficiency by using waste materials***Emissions behaviour*

Dust emissions from the clinker burning process remain unaffected by using wastes.

According to current knowledge, the use of suitable waste only has a minor influence on metal emissions from the clinker burning process because of the high retention capacity for particle-bound metals in the preheater and dust collector. It has to be noted that the way the fuels are fed into the kiln (feeding point) is very important because this can have an effect on the emissions (see Section 1.2.4.1). Factors determining metal emissions from the clinker production process are the behaviour of the individual metals in the rotary kiln system, the input situation as well as the collection efficiency of the dust collector. The input situation itself is determined by the metal concentration in the raw materials and fuels used. As the raw material:fuel mass ratio for clinker production is approximately 10:1, this means that the raw material-related inputs are decisive for the emissions. In operating practice, the use of wastes may result in a decreased or increased total input of individual elements into the kiln system. Non-volatile metals are, to a great extent, locked in the clinker matrix and leave the kiln system with the clinker stream. Semi-volatile metals like Pb and Cd form stable cycles in the kiln system. These elements are discharged from the cycle and a large amount is captured either in the clinker stream or in dust. Special cases due to their volatility are Hg and Tl. The prevailing process temperatures combined with a high volatility result in an insufficient removal capacity and establish a plant specific link between the input load and the emissions concentration in the stack. Depending on the exhaust gas temperature, mercury is present in particle-borne and/or vapour form in the dust collector. Therefore, to control mercury and volatile metal emissions it can be necessary to limit mercury and metal inputs into the kiln system. When firing waste fuels recovered from mixed waste fractions, a routine receiving analysis may be required for monitoring the volatile metals input (see Section 1.2.4.3.2).

The inorganic exhaust gas constituents NO<sub>x</sub>, HCl and HF remain unaffected by the choice of the feedstock. According to current knowledge, by using the appropriate feeding point to the kiln, the processing of wastes in the cement production process has no significant effects on these emissions. The same applies to the emissions components SO<sub>2</sub>, CO and TOC, provided that the input of volatile sulphur compounds or volatile organic compounds via the raw meal path is not increased through the processing of waste. Formed SO<sub>2</sub> is bound to the clinker in the rotary kiln or the precalciner without additional techniques.

The combustion conditions in rotary kiln systems ensure low emissions concentrations of PCDD/F. Waste materials likely to contain relevant concentrations of persistent organic substances, e.g. PCB-laden spent oil, are fed via the main firing system to ensure their reliable destruction. If there are doubts about the feed point selection in the individual case, reference measurements with and without using wastes should be performed. Indications from comprehensive measurement programmes are that in operating practice, PCDD/F emissions are well below the prescribed limit of 0.1 ng I-TEQ/m<sup>3</sup>, regardless of the waste used.

Wastes inserted to the secondary firing (see Sections 1.2.4.1 and 1.2.5.1) do not pass the high temperature zone of the rotary kiln which requires qualitative limitations for input and process parameters. However, in many modern precalciners, the temperature is above 850 °C and they have a residence time of longer than 2 seconds, therefore making them suitable for the use of wastes.

Examples of conditions and the result of the yearly emissions monitoring from German cement kiln using waste fuels are shown in Section 6.2.2.1, Table 6.5 and Table 6.6.

### *Impacts on energy efficiency*

Thermal energy demands can increase when using waste fuels with a higher moisture content, coarseness or a lower reactivity compared to, e.g. fine ground, dry and/or high calorific fuels. Lower energy efficiency might also result in higher emissions loads of air pollutants by increasing the flue-gas volume.

[3, Austria, 1997], [76, Germany, 2006], [86, EURITS, 2006], [137, Klein/Hoenig, 2006], [168, TWG CLM, 2007].

#### **1.3.4.14 Impacts on product quality by using wastes**

The use of wastes in the clinker burning process may change the metal concentrations in cement products. Depending on the total input via the raw materials and fuels, the concentration of individual elements in the product may increase or decrease as a result of waste processing.

As cement is blended with aggregates, e.g. gravel and sand, for the production of concrete or mortar, it is the behaviour of the metals in the building material (concrete or mortar) which is ultimately decisive for evaluating the environmentally relevant impacts of waste used in the clinker burning process.

Metal emissions from concrete and mortar are low. Results from comprehensive tests confirm that metals are firmly incorporated in the cement brick matrix. In addition, dry-packed concrete offers high diffusion resistance which further counteracts the release of metals.

Tests on concrete and mortar have shown that the metal concentrations in the eluates are noticeably below those prescribed, for instance, by national legislation. Storage under different and partly extreme conditions has not led to any environmentally relevant releases. This also holds true when the sample material is crushed or comminuted prior to the leaching tests.

Careful selection and monitoring of the waste materials ensure that the use of wastes does not result in metal emissions of any environmentally harmful magnitude. The metal emissions are partly orders of magnitude below the applicable air pollution control standards. The use of waste has no negative impact on the environmental quality of the product. Under these conditions, cement can continue to be used without restrictions for concrete and mortar production. The recyclability of these materials remains completely unaffected.

The content of metals in German cements are analysed on a regular basis. The last values were published in 2001. A comparison with results from earlier investigations showed that there was no increase in the metal content of the cements although there has been a remarkable increase in the use of waste materials over the respective period [76, Germany, 2006], [168, TWG CLM, 2007].

#### **1.3.5 Process losses/waste**

Process losses/waste originating from cement manufacture, mainly consists of the following materials:

- unwanted rocks which are removed from the raw materials during the preparation of the raw meal
- kiln dust removed from the bypass flow and the stack
- filtrate from the filter presses used in the semi-wet process is fairly alkaline and contains suspended solids
- dust arising from off-gas cleaning units, e.g. dust precipitator

- used sorption agents (granular limestone, limestone dust) arising from the flue-gas cleaning system
- packaging waste (plastic, wood, metal, paper, etc.) arising from the packaging step.

Parts of the accumulated process losses mentioned above, can be recycled and re-used within the plant due to process requirements and product specifications. Materials which cannot be recycled internally leave the plant to be used in other industries or to be supplied to external waste recycling or waste disposal facilities. Kiln dust can directly be re-used within the process of cement manufacturing or can be used for other purposes.

PCDD/F are also present in wastes and solid materials from the cement industry and in 2006 the following was reported by a study:

- cement kiln dust (CKD) and filter dust
  - average concentration of 6.7 ng I-TEQ/kg
  - maximum concentration of 96 ng I-TEQ/kg
- clinker
  - average concentration of 1.24 ng I-TEQ/kg
  - maximum concentration of 13 ng I-TEQ/kg.

This study also shows that, compared with other materials, dioxin levels in process losses/waste originating from cement manufacture are of the same magnitude as foods like fish, butter, breast milk, and less than the maximum permissible concentration of 100 ng TEQ per kg for sewage sludge applied to agricultural land [88, SINTEF, 2006].

### 1.3.6 Emissions to water

In general, cement production does not generate effluent. In cement production by using the dry or the semi-dry process, water is only used in small quantities, e.g. for cleaning processes. In principle, no emissions to water occur because water is recycled back into the process.

In the semi-wet process, slurry is used and dewatered in filter presses. In the wet process, water is used for grinding the raw materials and to form slurry. The raw materials used are often available with a high moisture content. The slurry is either fed directly into the kiln where the water is vaporised or first sent to a slurry dryer.

Water which is sometimes used in the cooling process for cooling down the clinker, is directly vaporised because of the high temperatures of clinker material.

A water balance from a specific example plant can be found in Table 6.24 in Section 6.2.2.3.

### 1.3.7 Noise

Noise emissions occur throughout the whole cement manufacturing process from preparing and processing raw materials, from the clinker burning and cement production process, from material storage as well as from the dispatch and shipping of the final products. The heavy machinery and large fans used in various parts of the cement manufacturing process can give rise to noise and/or vibration emissions, particularly from:

- chutes and hoppers
- any operations involving fracture, crushing, milling and screening of raw material, fuels, clinker and cement
- exhaust fans
- blowers

- duct vibration.

Plants are required to comply with reduction standards in compliance with national legislation, and noise surveys are being conducted and evaluated. Natural noise barriers, such as office buildings, walls, trees or bushes are used in the cement industry to reduce noise emissions. Where residential areas are located close to a plant, the planning of new buildings at the cement site is connected with a necessity to reduce noise emissions [45, Schorcht, 2006], [81, Castle Cement UK, 2006]

### 1.3.8 Odours

Odour emissions are very rarely a problem with a well operated plant. If the raw materials contain combustible components (kerogens) which do not burn when they are heated in the preheater, but instead only pyrolise, emissions of hydrocarbons can occur. These hydrocarbon emissions can be seen above the stack as a 'blue haze' or plume and can cause odours around the cement plant under unfavourable weather conditions.

Burning of fuels containing sulphur and/or use of raw materials containing sulphur can lead to odour emissions (a problem especially encountered in shaft kilns).

Furthermore, waste materials used as raw materials or fuels may lead to odour emissions, especially during different process steps such as preparation and storage. In cases when ammonia is used for NO<sub>x</sub> reduction, this may also lead to odour emissions during certain process steps, if not handled properly.

### 1.3.9 Monitoring

#### 1.3.9.1 Monitoring of parameters and emissions

To control kiln processes, continuous measurements are recommended for the following parameters:

- pressure
- temperature
- O<sub>2</sub> content
- NO<sub>x</sub>
- CO, and possibly when the SO<sub>x</sub> concentration is high
- SO<sub>2</sub> (it is a developing technique to optimise CO with NO<sub>x</sub> and SO<sub>2</sub>).

To accurately quantify the emissions, continuous measurements are recommended for the following parameters (these may need to be measured again if their levels can change after the point where they are measured to be used for control):

- exhaust volume (can be calculated but is regarded by some to be complicated)
- humidity (can be calculated but is regarded by some to be complicated)
- temperature
- dust
- O<sub>2</sub>
- NO<sub>x</sub>
- SO<sub>2</sub>, and
- CO.

Regular periodic monitoring is appropriately carried out for the following substances:

- metals and their compounds
- TOC
- HCl
- HF
- NH<sub>3</sub>, and
- PCDD/F.

However, it is also possible to measure and monitor TOC, NH<sub>3</sub>, HCl, and HF continuously and to sample PCDD/F and PCB continuously for analysis from 1 to 30 days. Furthermore, Hg is measured continuously in two Member States of the EU-27.

Measurements of the following substances may be required occasionally under special operating conditions:

- BTX (benzene, toluene, xylene)
- PAH (polyaromatic hydrocarbons), and
- other organic pollutants (for example chlorobenzenes, PCB (polychlorinated biphenyls) including coplanar congeners, chloronaphthalenes, etc.).

It is especially important to measure metals when wastes with enhanced volatile metal contents are used as raw materials or fuels. Furthermore, depending on the fuels used, the process conditions and the relevance of the emissions, it may be necessary to carry out additional measurements. The requirements of existing European and national regulations have to be considered, e.g. when co-incinerating waste, the requirements of [Chapter IV of and Annex VI to the Directive 2010/75/EU](#) have to be met.

If waste is used in cement kilns, often emissions of TOC and mercury, especially in the case of using sewage sludge, are monitored from the exhaust gas of cement kilns (in some cases continuously), additionally to the regular continuous measurements of dust, NO<sub>x</sub>, SO<sub>2</sub> and CO emissions, which are carried out. Further information regarding continuous measurements of mercury in German cement plants can be found in the conclusions and recommendations section for the cement industry (see Section 5.1). Depending on the input and the types of waste fuels used, process conditions and the relevance of the emissions, additional measurements are carried out for HCl, HF, heavy metals, benzo-a-pyrene, benzene and polychlorinated dibenzo-p-dioxins (PCDD) and polychlorinated dibenzofurans (PCDF). Furthermore, for the use of waste often recurrent measurements are carried out, e.g. once a year [76, Germany, 2006].

It is appropriate to have all these substances measured on at least one occasion to provide data when applying for the plant's first [IED](#) permit.

Additional useful information can be found in the Reference Document on the General Principles of Monitoring [151, European Commission, 2003].



## 1.4 Techniques to consider in the determination of BAT

**\*\*NOTE to Article 13 Forum members: Old introductory text have been deleted and replaced with the new standard text adapted to the specificities of the CLM BREF\*\***

This section describes techniques (or combinations thereof), and associated monitoring, considered to have the potential for achieving a high level of environmental protection in the activities within the scope of this document. The techniques described will include both the technology used and the way in which the installations are designed, built, maintained, operated and decommissioned.

It covers environmental management systems, process-integrated techniques and end-of-pipe measures. Waste prevention and management, including waste minimisation and recycling procedures are also considered, as well as techniques that reduce the consumption of raw materials, water and energy by optimising use and reuse.

Annex III to the Directive lists a number of criteria for determining BAT, and the information within this chapter will address these considerations. As far as possible, the standard structure in Table 1.30 is used to outline the information on each technique, to enable a comparison of techniques and the assessment against the definition of BAT in the Directive.

This section does not necessarily provide an exhaustive list of techniques which could be applied in the sector. Other techniques may exist, or may be developed, which could be considered in the determination of BAT for an individual installation.

Type of information considered	Type of information included
Description	A brief description of the technique using, as appropriate, chemical or other equations, pictures, diagrams and flow charts
Achieved environmental benefits	The <b>main</b> potential environmental benefits to be gained through implementing the technique (including reduced consumption of energy; reduced emissions to water, air and land; raw material savings; as well as production yield increases, reduced waste, etc.).
Cross-media effects	<p>Relevant negative effects on the environment due to implementing the technique, allowing a comparison between techniques in order to assess the impact on the environment as a whole. This may include issues such as:</p> <ul style="list-style-type: none"> <li>• consumption and nature of raw materials and water</li> <li>• energy consumption and contribution to climate change</li> <li>• stratospheric ozone depletion potential</li> <li>• photochemical ozone creation potential</li> <li>• acidification resulting from emissions to air</li> <li>• presence of particulate matter in ambient air (including microparticles and metals)</li> <li>• eutrophication of land and waters resulting from emissions to air or water</li> <li>• oxygen depletion potential in water</li> <li>• persistent/toxic/bioaccumulable components (including metals)</li> <li>• generation of residues/waste</li> <li>• limitation of the ability to reuse or recycle residues/waste</li> <li>• generation of noise and/or odour</li> <li>• increased risk of accidents.</li> </ul> <p>The Reference Document on Economics and Cross-media Effects (ECM) should be taken into account.</p>
Operational data	Actual and plant-specific performance data (including emission levels, consumption levels – of raw materials, water, energy – and amounts of residues/wastes generated).

Type of information considered	Type of information included
	<p>Any other useful information on the following items:</p> <ul style="list-style-type: none"> <li>• how to design, operate, maintain, control and decommission the technique</li> <li>• emission monitoring issues related to the use of the technique</li> <li>• sensitivity and durability of the technique</li> <li>• issues regarding accident prevention.</li> </ul>
Applicability	<p>It is indicated whether the technique can be applied throughout the sector. Otherwise, the main general technical restrictions on the use of the technique within the sector are indicated. These may be:</p> <ul style="list-style-type: none"> <li>• an indication of the type of plants or processes within the sector to which the technique cannot be applied;</li> <li>• constraints to implementation in certain generic cases, considering, e.g.: <ul style="list-style-type: none"> <li>• whether it concerns a new or an existing plant, taking into account factors involved in retrofitting (e.g. space availability) and interactions with techniques already installed</li> <li>• plant size, capacity or load factor</li> <li>• quantity, type or quality of product manufactured</li> <li>• type of fuel or raw material used.</li> </ul> </li> </ul> <p>These restrictions are indicated together with the reasons for them.</p> <p>These restrictions are not meant to be a list of the possible local conditions that could affect the applicability of the technique for an individual plant</p>
Economics	<p>Information on the costs (capital/investment, operating and maintenance including details on how these costs have been calculated/estimated) and any possible savings (e.g. reduced raw material or energy consumption, waste charges, reduced payback time compared to other techniques), or revenues or other benefits including details on how these have been calculated/estimated.</p> <p>The Reference Document on Economics and Cross-media Effects (ECM) and the Reference Document on the General Principles of Monitoring (MON) are taken into account with regard to economic aspects and monitoring costs, respectively.</p>
Driving force for implementation	<p>Where applicable, specific local conditions, requirements (e.g. legislation, safety measures) or non-environmental triggers (e.g. increased yield, improved product quality, economic incentives – e.g. subsidies, tax breaks) which have driven or stimulated the implementation of the technique to date.</p>
Example plants	<p>Reference to a plant(s) where the technique has been implemented and from which information has been collected and used in writing the section. An indication of the degree to which the technique is in use in the EU or worldwide.</p>
Reference literature	<p>Literature or other reference material (e.g. books, reports, studies) that was used in writing the section and that contains more detailed information on the technique. When the reference material consists of a large number of pages, reference will be made to the relevant page(s) or section(s).</p>

**Table 1.30: Information for each technique**

### 1.4.1 Consumption of raw materials

#### Description and achieved environmental benefits

Recycling and/or re-use of collected dust to the production processes reduces the total consumption of raw materials. This recycling may take place directly in the kiln or kiln feed (the alkali metal content being the limiting factor) or by blending with finished cement products.

The use of suitable wastes as raw materials can reduce the input of natural resources, but should always be done with a satisfactory control of the substances introduced to the kiln process.

#### Cross-media effects

Saving of natural resources.

By using suitable wastes as raw material and depending on their characteristics, it may be possible that different emissions occur.

Costs for the quality control of wastes and emissions monitoring may increase.

#### Operational data

See Section 1.2.4.2.

#### Applicability

This measure is, in principle, applicable to the cement industry regarding quality control, volatile organics and heavy metal content.

#### Economics

Costs for raw materials can be reduced.

#### Driving force for implementation

Legal requirements.

Local conditions.

Economic consideration.

#### Example plants and reference literature

Cement plants in the EU-27.

[168, TWG CLM, 2007].

### 1.4.2 Reduction of energy consumption (energy efficiency)

In this context, useful information can also be found in the Reference Document on Best Available Techniques for Energy Efficiency (ENE) [181, European Commission, 2008].

#### 1.4.2.1 Reduction of thermal energy use

Thermal energy use can be reduced by considering and implementing different techniques, such as implementing thermal energy optimisation techniques in the kiln system (see Section 1.4.2.1.1.). Several factors affect the energy consumption of modern cement kilns, such as raw material properties, e.g. moisture content, burnability (see Section 1.4.2.1.2), the use of fuels with different properties and varying parameters (see Section 1.4.2.1.3) as well as the use of a gas bypass system (see Section 1.4.2.1.4). The techniques can be applied individually. However all techniques have to be considered in context with each other.

Furthermore, the production capacity of the kiln has an influence on the energy demand.

### 1.4.2.1.1 Kiln systems

#### Description

Kiln systems with multistage (four to six stages) cyclone preheaters with an integral calciner and tertiary air duct are considered standard technique for new plants and major up grades. In some cases of raw material with a high moisture content, three stage cyclone plants are used. Under optimised circumstances such a configuration will use 2900 – 3300 MJ/tonne clinker.

Thermal energy optimisation techniques can be implemented at the different units of the plant including:

- cooler:
  - installation of a modern clinker cooler, e.g. stationary preliminary grate
  - use of cooler grate plates offering a greater flow resistance to provide a more uniform cooling air distribution
  - controlled cooling air supply to the individual grate sections
- kiln:
  - high capacity utilisation
  - optimised length:diameter ratio
  - optimised kiln design with regards to the fuel type which is inserted
  - optimised kiln firing systems
  - uniform and stable operating conditions
  - optimisation of process controls
  - tertiary air duct
  - near-stoichiometric, but oxidising kiln conditions
  - use of mineralisers
  - reducing air-in leakage
- calciner:
  - low pressure drop
  - uniform distribution of the hot meal in the kiln riser
  - minimal coating formation due to low circulation of alkalis
  - extensive precalcination of the raw meal
- preheater:
  - low pressure drop and a high degree of heat recuperation in the cyclones
  - high cyclone collection rate
  - uniform meal distribution over the gas duct cross-sections
  - uniform distribution of solid and gas streams in a two-string preheater
  - cyclone stages (three to six cyclones in total)
- material handling:
  - low moisture content of raw materials and fuels
  - easily combustible fuels with a high calorific value
  - homogenising and even feeding (precise metering) of kiln feed material
  - homogenising and even feeding of fuels
- mills:
  - compound operation of mills.

#### Achieved environmental benefits

Reduction of thermal energy consumption.

#### Cross-media effects

The use of a gas/air exchanger or a quench system for long kilns as well as a gas bypass in preheater/precalciner kilns increases fuel energy.

For the use of flame cooling, additional heat could be required to evaporate the water which decreases the energy efficiency.

Lower numbers of cyclones induces higher thermal losses with the flue-gas leaving the preheater.

### **Operational data**

Under the optimised conditions of a short-term performance test (e.g. 36 hours performance test) the thermal energy use is 2900 – 3300 MJ/tonne clinker. Due to events deviating from the regular operating conditions (e.g. start-ups and shutdowns) the yearly average values are about 160 – 320 MJ/tonnes clinker higher.

In cases when plants are suitable and designed especially for the use of certain types of waste fuels, thermal energy consumption can still be in the range of between 3120 – 3400 MJ/t clinker. Properties of the waste fuels used, e.g. calorific value, reactivity, coarseness, influence the energy efficiency (see Sections 1.2.4.3 and 1.3.3.3) [92, Austria, 2006], [162, A TEC, 2006], [171, A TEC, 2007].

Values are calculated and valid for a kiln system with a capacity of 3000 t/d. The production capacity has an influence on the energy demand as well. Burning clinker in kilns with a higher capacity of, e.g. 5000 t/d, saves about 100 MJ/tonne clinker while the energy consumption of smaller kilns, e.g. producing 1500 t/d, is up to 200 MJ/tonne clinker higher. These effects are mainly due to different wall heat losses per tonne of clinker produced. An evaluation of a kiln's energy consumption necessarily has to take these effects into account [84, CEMBUREAU, 2006].

The more cyclone preheater stages there are, the higher the energy efficiency of the kiln process will be. The lowest energy consumption can be achieved with five or six cyclones (see Section 1.3.3.1 and Table 1.17). However, the number of cyclone stages is mainly determined by the moisture content of the raw material (see also Section 1.4.2.1.2).

### **Applicability**

The appropriate number of cyclone stages is determined by the throughput and the moisture content of raw materials and fuels which have to be dried by the remaining exhaust gas heat because local raw material situations vary widely regarding moisture content or burnability [76, Germany, 2006].

Several impacts can affect the energy consumption of up-to-date plants with precalciners and cyclone preheaters, e.g.:

- raw material properties like moisture content or burnability (see Sections 1.2.2, 1.2.4.2 and 1.4.2.1.2)
- the use of fuels with varying properties (see Sections 1.2.3, 1.2.4 and 1.4.2.1.3)
- the use of a gas bypass system (see Sections 1.2.5.4.1 and 1.4.2.1.4)
- target clinker quality
- kiln size and capacity.

### **Economics**

Energy use (thermal and electrical) typically accounts for 30 – 40 % of the production costs.

### **Driving force for implementation**

Legal requirements.

Local conditions.

Energy costs as well as emissions trading lead a way towards energy efficiency.

### Example plants and reference literature

Cement plants in the EU-27.

[9, CEMBUREAU, 1997 November], [60, VDI 2094 Germany, 2003], [76, Germany, 2006], [81, Castle Cement UK, 2006], [84, CEMBUREAU, 2006], [86, EURITS, 2006], [92, Austria, 2006], [136, European Commission, 1993], [153, Castle Cement UK, 2007], [154, CEMEX UK, 2006], [162, A TEC, 2006], [168, TWG CLM, 2007], [171, A TEC, 2007], [181, European Commission, 2008].

#### 1.4.2.1.2 Raw material properties

##### Description and achieved environmental benefits

The desired throughput and the moisture content of the raw materials influence the overall energy efficiency. These parameters determine the appropriate number of cyclone stages to be used, as the materials will have to be dried, preferably by the exhaust gas heat (see Sections 1.2.4.2, 1.3.3 and Table 1.17). The higher the moisture content, the higher the energy demand will be. It has to be noted that higher numbers of cyclones induces lower thermal losses which leave the preheater with the flue-gases.

##### Cross-media effects

Some fuels also contain a part of wet minerals used as raw material which are dried within the kiln system resulting in an increase of the specific energy consumption per tonne of clinker.

##### Operational data

For raw material input to the kiln which contains less than 8.5 % moisture, on a modern cement plant the drying can be completed using the exhaust gas from a four, five or six stage preheater. The sixth cyclone stage will save about 60 MJ/tonne clinker compared with a five stage preheater in the case of, where a reduced need for drying energy exists.

Calculated for the kiln preheater system alone, a four stage instead of a five stage cyclone preheater, requires an additional 90 MJ/tonne clinker approximately. With three cyclone stages the difference in energy demand rises further to above 250 MJ/tonne clinker. Three cyclone stages are only used in special cases with very wet material.

However, at raw material moisture content greater than 8.5% and up to 10 – 11 %, fewer cyclone stages are preferable (e.g. four) so that the heat can be utilised in the drying process (raw mill).

##### Applicability

Applicable, in principle, to the cement industry.

##### Economics

No data available.

##### Driving force for implementation

Legal requirements.

Local conditions.

### Example plants and reference literature

Cement plants in the EU-27.

[9, CEMBUREAU, 1997 November], [60, VDI 2094 Germany, 2003], [76, Germany, 2006], [84, CEMBUREAU, 2006], [81, Castle Cement UK, 2006], [86, EURITS, 2006], [92, Austria, 2006], [136, European Commission, 1993], [137, Klein/Hoenig, 2006], [153, Castle Cement UK, 2007], [154, CEMEX UK, 2006], [168, TWG CLM, 2007].

### 1.4.2.1.3 Fuel properties

#### Description

Characteristics of the fuels used such as adequate calorific value, low moisture content, adequate content of sulphur, metals, halogen compounds and volatiles as well as air-entraining injection have positive influences on the specific energy consumption of the kiln.

Preparation of fossil fuels like coal or lignite partly or completely dried outside of the kiln system, even outside of the cement plant, lead to improved energy efficiency of the kiln system because it is one of the main impacts on energy consumption. Lignite, for example, can be extracted with a moisture content of above 50 % and needs to be dried before delivery to the cement plant. Furthermore, the use of excess heat for drying fuels leads to thermal energy savings. Replacing fuels containing higher levels of moisture by dried fuels results in a decrease of the energy consumption per tonne of clinker in the kiln system.

#### Achieved environmental benefits

The practice to operate the calciner with a wide range of fuel grades, from highly reactive to extremely unreactive influences the energy efficiency. The use of a finely ground, dry and adequate calorific fuel compared to a low reactive or coarse fuel leads to an improved energy efficiency.

#### Cross-media effects

Some fuels also contain a part of wet minerals used as raw material which are dried into the kiln system resulting in an increase of the specific energy consumption per tonne of clinker.

By using wastes and depending on their characteristics, it may be possible that different emissions occur.

A high substitution rate of waste fuels along with less reactive or coarse fuels will relate to an increased amount of fuels that have to be used in order to achieve the thermal energy demand (see Sections 1.3.3, 1.3.3.3, 6.2.2.2 and Table 6.21).

Additional energy may be used for drying fuels outside of the kiln system.

#### Operational data

A comparison between identical kiln systems fired with hard coal on the one hand and lignite on the other hand, both of which commonly use fossil fuels, shows a difference of nearly 100 MJ/tonne clinker due to diverse fuel qualities.

The use of a finely ground coal compared to the use of a low reactive or coarse fuel can lower the energy demand of, e.g. more than 300 MJ/tonne clinker. Low thermal energy demand can be achieved (also for smaller plants) by using easily combustible fuels with a low moisture content.

In cases when plants are suitable and designed especially for the use of certain types of waste fuels, thermal energy consumption can still be as low as 3120 – 3400 MJ/t clinker. Parameters and properties of the waste fuels used, e.g. adequate calorific value, reactivity, coarseness, influence the energy efficiency (see Sections 1.2.4.3 and 1.3.3.3) [92, Austria, 2006], [162, A TEC, 2006], [171, A TEC, 2007]. Furthermore, an energy consumption of 3473 kJ/kg has been reported for a five stage precalciner kiln [81, Castle Cement UK, 2006], [163, Castle Cement UK, 2006], [168, TWG CLM, 2007].

#### Applicability

Applicable, in principle, to all cement kiln types.

When defining a fuel mix, the local availability of the fuels, the technical possibilities and the long term guarantee of supply are the main parameters that are taken into consideration.

By using waste fuels, the calorific value of these wastes has to be taken into account. It has to be noted that by using waste fuels with a lower calorific value, it can be necessary to burn a higher amount of waste fuels in comparison to fossil fuels in order to achieve the thermal energy demand.

### **Economics**

The costs of different types of fossil and/or waste fuels and their preparation vary widely.

### **Driving force for implementation**

Legal requirements.

Economical requirement.

Local conditions.

### **Example plants and reference literature**

Cement plants in the EU-27 specifically in Austria and the UK.

[9, CEMBUREAU, 1997 November], [60, VDI 2094 Germany, 2003], [76, Germany, 2006], [81, Castle Cement UK, 2006], [84, CEMBUREAU, 2006], [86, EURITS, 2006], [92, Austria, 2006], [136, European Commission, 1993], [153, Castle Cement UK, 2007], [154, CEMEX UK, 2006], [162, A TEC, 2006], [163, Castle Cement UK, 2006], [168, TWG CLM, 2007], [171, A TEC, 2007].

#### **1.4.2.1.4 Gas bypass system**

##### **Description and achieved environmental benefits**

Raw material and fuels containing low levels of chlorine, sulphur and alkalis can minimise the enrichment cycle resulting from the internal circulation between the kiln and preheater. Furthermore, the deposit formation in the area of the kiln inlet, the calciner and the two bottom stages can be minimised which can be caused by higher concentrations. As a uniform kiln operation with minimised disturbances is the basis for energy efficient clinker production, shutdowns resulting from coating formation should be avoided. A low circulation of alkalis, chlorine and, to a lesser extent, sulphur can minimise the use of a gas bypass at the kiln inlet. By removing part of the process gas not only are chlorine, sulphur and alkalis discharged, but also other substances (see Section 1.2.5.4.1).

##### **Cross-media effects**

The removal of hot raw material and hot gas leads to a higher specific energy consumption of about 6 – 12 MJ/tonne clinker per per cent of removed kiln inlet gas. Hence, minimising the use of gas bypass has a positive effect on the specific energy consumption.

##### **Operational data**

See Section 1.3.3 for the use of energy.

##### **Applicability**

Applicable, in principle, to the cement industry.

##### **Economics**

No data available.

##### **Driving force for implementation**

Requirements of process technique.

##### **Example plants and reference literature**

Cement plants in the EU-27.

[9, CEMBUREAU, 1997 November], [60, VDI 2094 Germany, 2003], [76, Germany, 2006], [84, CEMBUREAU, 2006], [86, EURITS, 2006], [81, Castle Cement UK, 2006], [92, Austria, 2006], [136, European Commission, 1993], [153, Castle Cement UK, 2007], [154, CEMEX UK, 2006].



#### 1.4.2.1.5 Reduction of the clinker content of cement products

##### **Description**

A technique to reduce energy use and emissions from the cement industry, expressed per unit mass of cement product, is to reduce the clinker content of cement products. This can be done by adding fillers and additions, for example, sand, slag, limestone, fly ash and pozzolana, in the grinding step.

##### **Achieved environmental benefits**

Reduction of energy use.  
Reduction of emissions to air.  
Saving of natural resources.  
Avoidance of landfilling waste materials.

##### **Cross-media effects**

Adding fillers and additions into the final product at the cement plant ensures controlling of storage and handling materials as well as controlling quality requirements of the finished cement.

##### **Operational data**

In Europe, the average clinker content in cement is 80 – 85 %. Many manufacturers of cement are working on techniques to lower the clinker content further. One reported technique claims to exchange 50 % of the clinker with maintained product quality/performance and without increasing production costs. Cement standards define some types of cement with less than 20 % clinker, the balance being made up of blast furnace slag. However, cement types with a low clinker content are for special use only.

##### **Applicability**

Applicable, in principle, to the cement industry.

##### **Economics**

No data available.

##### **Driving force for implementation**

Legal requirements.  
Economic requirements.  
Availability of suitable waste materials.  
Requirements regarding technical specification and carbon efficiency.  
Requirements in accordance with cement standards.

##### **Example plants and reference literature**

Cement plants in the EU-27.  
[9, CEMBUREAU, 1997 November], [168, TWG CLM, 2007].

#### 1.4.2.2 Reduction of electrical energy use

##### **Description**

Electrical energy use can be minimised through the installation of power management systems and the utilisation of energy efficient equipment such as high pressure grinding rolls for clinker comminution and variable speed drives for fans as well as, in some cases, replacing old raw material mills with new mills (see Section 1.3.3.2). By using improved monitoring systems and reducing air leaks into the system, the use of electricity can also be optimised. Some of the reduction techniques described in the next sections will also have a positive effect on energy use, for example, process control optimisation.

### **Achieved environmental benefits**

Reduction and minimisation of electrical use.  
Saving of resources and reduction of emissions and waste.

### **Cross-media effects**

No issues.

### **Operational data**

A comparison of key characteristics from grinding technique examples are shown in Section 1.3.3 and Table 1.19. In some cases, the use of electricity was minimised by replacing old raw material mills with new alternatives.

### **Applicability**

Applicable, in principle, to all cement kilns.

### **Economics**

In 2006, electrical energy use typically accounted for 15 – 25 % of the total cement production costs (see Section 1.3.3.2).

### **Driving force for implementation**

Legal requirements.  
Economic requirements, cost savings.  
Local conditions.

### **Example plants and reference literature**

Cement plants in the EU-27.  
[76, Germany, 2006], [81, Castle Cement UK, 2006], [168, TWG CLM, 2007], [181, European Commission, 2008], [182, TWG CLM, 2008].

## **1.4.2.3 Process selection**

### **Description**

The selected process will affect the emissions of all pollutants, and will also have a significant effect on the energy use, as also shown from a study concerning energy technologies in the cement sector commissioned by the European Commission in 1993. A series of technical improvements or modifications along with corresponding energy saving potentials were identified, e.g. process modifications, improvements for the grinding process and raw meal preparation as well as development of energy management systems [136, European Commission, 1993].

The thermal energy required for raw material drying and preheating mainly depends on the moisture content of the raw material as shown by examples in Section 1.3.3.1 and Table 1.17. The lower the moisture content is, the lower the energy demand will be.

For new plants and major upgrades, a dry process kiln with multistage preheating and precalcination is considered to be state of the art. The wet process kilns operating in Europe are generally expected to convert to the dry process when renewed [12, Netherlands, 1997], and so are semi-dry and semi-wet processes.

### **Achieved environmental benefits**

Reduction of energy consumption.  
Saving of resources and reduction of emissions and waste.

### **Cross-media effects**

No issues.

**Operational data**

On modern cement plants, if the raw material input is less than 8.5 % moisture, the drying can be completed using the exhaust gas from a four or five stage preheater and without supplementary heat. From an example, the strategy for having the most efficient plant required the closure of plants that were located on chalk-based raw materials with a high moisture content; chalk contains over 20 % moisture.

In the UK (Padeswood Works), two wet process kilns with a total heat requirement of 5649 MJ/t clinker were replaced with a single precalciner. In comparison to these two wet process kilns, in 2006 the new dry precalciner kiln had a total heat requirement of 3473 MJ/t clinker which refers to an improvement of about 2176 MJ/t clinker and a reduction in the need for energy of approximately 36 %. However, this heat requirement is higher than would be expected from a five stage precalciner kiln because the organic carbon present in the waste which is used as raw material, burns in the upper cyclone stages of the preheater tower leading to high top of tower temperatures. As part of the process development, the tower temperatures will be reduced which will decrease the overall heat consumption to around 3150 MJ/t. The kiln is permitted to use up to 100 % waste fuel; however, in 2008, operational performance was around 30 % [81, Castle Cement UK, 2006], [163, Castle Cement UK, 2006], [182, TWG CLM, 2008].

**Applicability**

Applicable, in principle, to the cement industry for new installations/major upgrades.

**Economics**

Process changes from wet to dry are highly cost-intensive and may cost up to EUR 100 million.

**Driving force for implementation**

Legal requirements.

Local conditions.

**Example plants and reference literature**

Padeswood Works, Castle Cement UK.

[12, Netherlands, 1997], [81, Castle Cement UK, 2006] [136, European Commission, 1993] [163, Castle Cement UK, 2006], [168, TWG CLM, 2007], [182, TWG CLM, 2008].

**1.4.2.4 Energy recovery from kilns and coolers/cogeneration****Description**

The employment of cogeneration plants for steam and electricity or of combined heat and power plants is, in principle, applied in cement manufacturing. This is due to the simultaneous demand of heat and electric power which has for a long time been pursued (see Section 1.2.5.8). The Organic Rankine Cycle (ORC) process and conventional steam cycle processes are in operation. Furthermore, excess heat is recovered from clinker coolers or kiln off-gases for district heating.

The essential feature of the cogeneration plant is the driving engine; however, generating power from low temperature exhaust gas is applied in two cement plants. Most commonly excess heat is recovered from the clinker cooler and, to a lesser extent, from the kiln off-gases.

**Achieved environmental benefits**

Recovery of excess heat from the process and cogeneration of steam and electrical power along with increased independency from energy costs and reduction of CO<sub>2</sub> emissions.

Saving of resources and reduction of emissions.

**Cross-media effects**

No issues.

### **Operational data**

#### *Conventional steam cycle process and Organic Rankine Cycle (ORC) process*

At Slite cement plant in Sweden, the conventional steam cycle process is used. The recoverable heat is sent to an existing electricity plant situated adjacent to the cement works, operated by a third party who re-utilises a steam turbine to generate electricity. The steam is generated in a two step heat recovery boiler system, one at the clinker cooler and one in the down duct of the kiln. This plant supplies energy of about 6 MW. Calculating from 1999, the investment costs were EUR 8 million for the boiler and steam distribution system, of which 25 % was subsidised. The re-used existing steam turbine contributed significantly to the economics of the installation; however, no costs were accounted for. The annual electricity production is approximately 50 GWh equalling  $\frac{1}{4}$  of the plants total power need. A more detailed description can be found in Section 6.2.3.1.

The Organic Rankine Cycle (ORC) is used at a cement plant in Lengfurt in Germany to recover low temperature waste heat from the clinker cooler for generating power. This technique is essentially based on the use of an organic motive medium (pentane). Results have shown that 1.1 MW electrical power can be generated with the given mode of operation. The achieved availability was 97 % of the operation time of the cement kiln. The clinker cooler has a waste heat output via the clinker cooler exhaust air of 14 MW and an exhaust gas temperature of between 300 – 350 °C of which approx. 9 MW on average is extracted. This ORC technique at Lengfurt cement plant has been operating well for about 10 years. Further descriptions can be found in Section 6.2.3.2.

#### *Recovery from clinker coolers or kiln off-gases for district heating*

Waste heat can also be recovered from the clinker cooler for supplying hot water. In most cases, the boiler is on the clean gas side of the filter, as the dust collector needs to be an ESP in such cases. Alternatively, a sturdy, abrasion safe waste heat boiler is needed if a fabric filter is installed as a dedusting device after the boiler. Plants having waste heat recovery hot water systems fitted include amongst others Burglengenfeld in Germany, and Büyükçekmece and Canakkale both in Turkey.

The Swedish cement plant at Skövde also has a heat recovery boiler situated in the kiln off-gas down duct. As at the Slite cement plant, the heat recovery is less than expected here with 1.2 MW, rather than the design of 2.5 MW. The situation is similar to that in Slite: the properties of the typical fine dust from the preheater tower prevent effective heat exchange. This remains a problem and challenges the use of preheater off-gas as a heat source, technically as well as economically.

### **Applicability**

Applicable, in principle, to all cement kilns if sufficient excess heat is available and appropriate process parameters can be met. Local conditions and cost aspects have to be considered.

### **Economics**

A large full sized power plant costs on average approximately between EUR 0.8 and 1.2 million per MW power generation installed. The plant at Lengfurt in Germany (Organic Rankine Cycle (ORC) process) is to a factor of approx. 3.3 above that. The ORC plant of Lengfurt with 1 MW is particularly small; however, it is economically feasible due to being part funded by the German government.

The situation is similar for the Slite cement plant (conventional steam cycle process), the steam turbine generator is set with 25 % funding and the availability of a vital and expensive part of the equipment. With the sole proceeds from the operation, justification for a full investment in a water steam boiler and power generation system is difficult.

With more new effective preheater towers and clinker coolers coming on line, the excess unutilised heat will be reduced and the scale of economics for cogeneration may not be favourable, especially where the majority of the heat is needed for material drying processes.

Waste heat recovery from the kiln and clinker cooler for power generation may be assessed case by case. The economic viability may also be dependent on the local electricity price and the size of the plant.

Other than heat recovery for district heating, especially from a clinker cooler, heat recovery can be feasible if:

- a certain amount of excess heat is available
- recovered heat is saleable via the district heating
- district heating exists or is financed and operated by a partner
- a generator generates electricity, which can be used either for the plant or can be supplied to the public power grid.

#### **Driving force for implementation**

Legal requirements, e.g. the Cogeneration Directive [94, European Union, 2004].

Reduction of costs.

Saving of resources.

#### **Example plants and reference literature**

Along with the two cogeneration power plants from waste heat which are described above (cement plants in Sweden and Germany), there are also other plants such as Alpena (40 MW) in Michigan, US; Halla (10.6 MW) in Korea; Tagada and Kanda both in Japan [133, CEMBUREAU/Federhen, 2007].

[76, Germany, 2006], [78, E. Baatz + G. Heidt, 2000], [79, Germany, 2001], [94, European Union, 2004], [168, TWG CLM, 2007], [181, European Commission, 2008].

### **1.4.3 General techniques**

#### **1.4.3.1 Process control optimisation**

##### **Description**

Optimisation of the clinker burning process is usually done to reduce the heat consumption, to improve the clinker quality and to increase the lifetime of the equipment (the refractory lining, for example) by stabilising process parameters. Reduction of emissions, such as NO<sub>x</sub>, SO<sub>2</sub> and dust, are secondary effects of this optimisation. Smooth and stable kiln operation close to design values for process parameters is beneficial for all kiln emissions. Optimisation includes techniques like homogenising the raw material, ensuring uniform coal dosing and improving the cooler's operation. To ensure that the feed rate of solid fuel is steady with minimal peaks, it is essential to have good designs of hoppers, transport conveyors and feeders, such as a modern, gravimetric solid fuel feed system.

NO<sub>x</sub> reduction is caused by the reduced flame and burning temperatures and the reduced consumption of fuel, as well as zones with a reducing atmosphere in the kiln system (see also Section 1.4.5.1.6). Control of oxygen content (excess air) is critical to NO<sub>x</sub> control. Generally, the lower the oxygen content (excess air) at, for instance, a cement kiln back-end, the less NO<sub>x</sub> is produced. However, this has to be balanced against increases in CO and SO<sub>2</sub> at lower oxygen levels [37, UK, 1996].

The effect of kiln process optimisation on SO<sub>2</sub> emissions is considerable for long wet and dry kilns, and marginal for preheater kilns. The SO<sub>2</sub> reduction is caused by CaO resulting from the calcination process, the reduced SO<sub>2</sub> volatility at lower flame and burning temperatures, and the oxidising atmosphere in the kiln, together with stable kiln operation [9, CEMBUREAU, 1997 November].

Avoidance of kiln upsets and of CO trips when ESPs are applied, reduces dust emissions, and in doing so also reduces emissions of any substances adsorbed to the dust, for example metals.

Modern control systems with faster measuring and control equipment can allow higher switch off criteria and thereby reduce the number of CO trips (see also Sections 1.3.4.1.1, 1.4.5.3 and 6.2.6).

Several cement equipment suppliers have developed expert automatic control systems based usually on the control of the burn by monitoring NO<sub>x</sub> levels [37, UK, 1996].

Monitoring and measurement of process parameters and emissions are an essential part of process control optimisation and of achieving a stable kiln process.

### **Achieved environmental benefits**

Reduced flame and burning temperatures cause NO<sub>x</sub> emissions reductions. Furthermore, fuel consumption can be reduced. Dust emissions are reduced by avoidance of kiln upsets and avoidance of CO trips by using ESPs.

### **Cross-media effects**

Reduction of emissions and fuel consumption.

### **Operational data**

Depending on initial NO<sub>x</sub> levels, NO<sub>x</sub> reductions of up to 30 % and SO<sub>2</sub> reductions of up to 50 % have been reported for long wet and long dry kilns and is marginal for preheater kilns [9, CEMBUREAU, 1997 November].

### **Applicability**

Process control optimisation is applicable to all kilns and can include many elements ranging from instruction/training of the kiln operators to installation of new equipment such as dosing systems, homogenisation silos, preblending beds and new clinker coolers. The effect of process control optimisation on SO<sub>2</sub> emissions is considerable for long wet and long dry kilns, and marginal for preheater kilns.

By using ESPs, CO trip management is applicable in the cement industry (see Section 1.4.5.3).

### **Economics**

The costs of process control optimisation techniques vary widely, up to EUR 5 million.

The investment required for developed expert automatic control systems based usually on the control of the burn by monitoring NO<sub>x</sub> levels, i.e. a computer-based high level control system, is about EUR 300000, and additional investment may be necessary to install the required measuring and dosing systems at the plant.

Kiln optimisation is primarily done to reduce operating costs, increase capacity and improve product quality. The operating cost of an optimised kiln is usually reduced compared to the non-optimised state. The savings result from reduced fuel and refractory consumption, lower maintenance costs and higher productivity among other factors.

### **Driving force for implementation**

Legal requirements.

Local conditions.

### **Example plants and reference literature**

Cement plants in the EU-27.

[9, CEMBUREAU, 1997 November], [37, UK, 1996] [168, TWG CLM, 2007], [182, TWG CLM, 2008].

### 1.4.3.2 Choice of fuels and raw materials

#### Description

Careful selection and control of substances entering the kiln can reduce emissions. For example, limiting the sulphur content of both raw materials and fuels can reduce releases of SO<sub>2</sub>. The same is valid for raw materials and fuels containing other substances, for example nitrogen, metals, organic compounds, HCl, HF. There are, however, some differences between different kiln systems and feeding points. For example, fuel sulphur is not a problem for dry preheater and precalciner kiln systems, and all organic compounds in fuels fed through the main burner will be completely destroyed.

Limiting the chlorine content of input materials reduces formation of alkaline chlorides (and other metal chlorides), which can cause build-ups and upset kiln conditions and therefore can impair the performance of electrostatic precipitators, which in turn causes increased dust emissions. High alkali materials may also require some of the dust to be bled off, rather than be recycled within the kiln system, to avoid high alkali contents in the final product. In this case, use of low alkali materials can allow the dust to be returned to the process, thus reducing the waste generated by the process.

Different types of wastes can replace conventional fuels and raw materials. However, a careful quality control on specific characteristics and parameters of these wastes is essential (see Sections 1.2.4 and 1.2.4.3.2). Waste used as fuel selected with an appropriate calorific value and reactivity as well as a low content of moisture and pollutants can save fossil fuels (see Sections 1.3.3 and 1.4.3.3). Wastes used as raw materials which contain VOCs, halogenated compounds and mercury can be particularly problematic regarding emissions. Feeding materials with a high content of volatile metals into the kiln system should be avoided (see Sections 1.3.4.7, 1.3.4.7.1 and 1.4.7). The mercury content in materials has to be minimised and it can be necessary to limit mercury input into the kiln system (see Section 1.3.4.13). In this context, see also Section 6.2.2.1.1, where examples of concentration ranges for substances in waste are presented. Wastes containing VOCs/halogenated compounds can only be used if the volatile components can be decomposed at high temperatures along with a sufficient residence time. When waste is used, systematic monitoring is required.

#### Achieved environmental benefits

Careful selection of fuels and raw materials can limit the input of substances that can cause emissions. The use of waste fuels can save fossil fuels which, furthermore, can reduce landfilling.

#### Cross-media effects

Any types of fuels and raw materials including wastes may have an effect on emissions (especially those occurring from volatile metals, such as mercury).

#### Operational data

No data available.

#### Applicability

The techniques can, in principle, be carried out in the cement industry. The use of suitable waste materials is applicable where complete combustion of organic matter is assured and waste input control as well as emissions control guarantees a low level of emissions, e.g. metals and dioxins.

#### Economics

No data available.

#### Driving force for implementation

Legal requirements.  
Local conditions.

### Example plants and reference literature

Cement plants in the EU-27.

[74, CEMBUREAU, 2006], [76, Germany, 2006], [168, TWG CLM, 2007], [182, TWG CLM, 2008].

#### 1.4.3.3 Use of wastes as fuels

##### Description

Selected wastes with adequate (net) calorific values (see Section 1.3.3.3 and Table 1.20) can be used as fuels in a cement kiln, replacing conventional fossil fuels, like coal, if they meet certain specifications and characteristics (see Section 1.2.4.1, Section 1.2.4.3). Often, they can only be used after a certain pretreatment to provide tailor-made fuels for the clinker burning process (see Section 1.2.4.3.2). Different criteria play a decisive role in the selection of waste fuels as they can have an impact on kiln operation and on emissions, such as:

- physical criteria, e.g. air entrainability
- chemical criteria, e.g. chlorine, sulphur, alkali and phosphate content, reactivity and volatile metal content.

To guarantee the characteristics of the waste fuel, a quality assurance system is required. In particular, this includes provisions for the sampling, the sample preparation, the analysis and the external monitoring. More useful information can be found in the technical specifications of the European Committee for Standardisation, such as CEN/TC 343 'Solid Recovered Fuels'. In this context, see also Section 6.2.2.1.1, where examples of concentration ranges for substances in waste are presented.

Depending on the types of waste used and their characteristics, the points at which the fuels are added to the kiln have to be considered (see Section 1.2.5.1) because the way the fuels are fed into the kiln can have an effect on the emissions. In general, the highest combustion temperatures are experienced by fuels fed through the main burner. For all feed points, temperatures and residence times depend on kiln design and kiln operation (see Section 1.2.4.1). To meet the requirements of the **IED regarding waste co-incineration**, process gases have to maintain a temperature of 850 °C for two seconds (see Sections 1.2.4.3.2 and 1.3.4.5). When using waste with more than 1 % chlorine content then the operating conditions have to be 1100 °C and two seconds residence time.

To control emissions, some additional environmental equipment may be installed. Special control and process techniques are needed to maintain environmental, safety and quality standards.

For the use of hazardous wastes (liquid waste fuels), safety management has to be taken into account when handling, e.g. storage, feeding (see Section 1.2.4.3.3). Furthermore, safety management for potentially self igniting materials should be considered when using waste fuels derived from pretreated and sorted waste fractions.

##### Achieved environmental benefits

The selection of waste fuels is driven by a number of interrelated considerations, including the following main points:

- reduction of emissions, e.g. fossil CO<sub>2</sub>, NO<sub>x</sub>
- reduction of the use of natural resources, e.g. fossil fuels and raw materials.

##### Cross-media effects

The characteristics of the different types of waste fuels, e.g. moisture, calorific value, can affect the specific energy consumption per tonne clinker, e.g. a low (net) calorific value and a high moisture content could result in an increase of the specific energy consumption per tonne of



clinker. To achieve the same energy demand, the amount of used waste fuels with lower calorific values is higher compared to conventional fuels.

Depending on their characteristics, e.g. high volatile metal concentrations, waste fuels may have an effect on emissions. This can be controlled and minimised by appropriate input control.

### **Operational data**

When changing the fuel mix used, the specific energy consumption per tonne of clinker can vary due to various reasons, depending on the type of fuel and the calorific value of the fuels used. Literature shows that fossil fuels have calorific values (average, net.) of, e.g. 26 – 30 MJ/kg for typical coal, 40 – 42 MJ/kg for typical fuel oil and plastic material has a calorific value of between 17 and 40 MJ/kg. It has to be noted that, of these wastes, the calorific values vary very widely, by up to 40 MJ/kg. Calorific values of animal meal (carcase meal) used in cement kilns is reported as being within a range of between 14 to 22 MJ/kg.

### **Applicability**

The techniques can, in principle, be carried out in the cement industry provided that there is complete combustion of organic matter. Waste input control as well as emissions control guarantees a low level of emissions, e.g. metals and PCDD/F.

### **Economics**

In comparison to the use of fossil fuels, the use of waste fuels can reduce operational costs. Energy use typically accounts for 30 – 40 % of the production costs. The costs for fuels are, therefore, a significant part of the costs for manufacturing cement. Waste fuels may be less expensive than conventional fossil fuels although costs will vary with the type of waste fuels and local conditions. However, waste fuels have frequently be pretreated and made sufficiently homogeneous to be used in a cement kiln which can cause additional costs. Furthermore, additional monitoring and analysis costs can occur.

### **Driving force for implementation**

Economical requirements.  
Reduction of fuel costs.  
Local conditions.  
Availability of resources.

### **Example plants and reference literature**

Cement plants in the EU-27.

[59, European Union, 2000], [60, VDI 2094 Germany, 2003], [74, CEMBUREAU, 2006], [76, Germany, 2006], [92, Austria, 2006], [168, TWG CLM, 2007], [182, TWG CLM, 2008].

## **1.4.4 Emissions of dust (particulate matter)**

In this section, techniques to prevent channelled (See Sections 1.3.4.1.1 and 1.3.4.1.2) and diffuse (see Section 1.3.4.1.3) dust emissions are described. In this context, additional information can also be found in the BREF on Emissions from Storage and in the BREF on Common Waste Water and Waste Gas Treatment/Management Systems in the Chemical Sector [95, Sweden, 2006], [96, European Commission, 2006]

#### 1.4.4.1 Techniques for dusty operations

##### Description

Diffuse dust emissions sources mainly arise from the storage and handling of raw materials, fuels and clinker as well as from vehicle traffic used at the manufacturing site. A simple and linear site layout is advisable to minimise possible sources of diffuse dust. Proper and complete maintenance of the installation always has the indirect result of reducing diffuse dust by reducing air leakages and spillage points. The use of automatic devices and control systems also helps diffuse dust reduction, as well as continuous trouble-free operation.

Several different techniques for diffuse dust abatement are presented here, which can be applied individually or in combination (see 1.3.4.1):

- enclose/encapsulate dusty operations, such as grinding, screening and mixing
- cover conveyors and elevators, which are constructed as closed systems, if diffuse dust emissions are likely to be released from dusty material
- reduce air leakages and spillage points, completion of installation
- use automatic devices and control systems
- ensure trouble-free operations
- mobile and stationary vacuum cleaning for proper and complete maintenance of the installation:
  - during maintenance operations or in cases of trouble with conveying systems, spillage of materials can take place. To prevent the formation of diffuse dust during removal operations, vacuum systems should be used. New buildings can easily be equipped with stationary vacuum cleaning systems, while existing buildings are normally better fitted with mobile systems and flexible connections
  - in specific cases, a circulation process could be favoured for pneumatic conveying systems
- ventilation and collection in fabric filters:
  - as far as possible, all material handling should be conducted in closed systems maintained under negative pressure. The suction air for this purpose is then dedusted by a fabric filter before being emitted into the air
- use closed storage with an automatic handling system:
  - clinker silos and closed fully automated raw material storage areas are considered the most efficient solution to the problem of diffuse dust generated by high volume stocks. These types of storage are equipped with one or more fabric filters to prevent diffuse dust formation in loading and unloading operations
  - use storage silos with adequate capacities, level indicators with cut out switches and with filters to deal with dust-bearing air displaced during filling operations
- use flexible filling pipes for dispatch and loading processes, equipped with a dust extraction system for loading cement, which are positioned towards the loading floor of the lorry.

##### Achieved environmental benefits

Reduction of diffuse dust emissions.

Noise reduction is also possible by enclosing machinery.

##### Cross-media effects

Increase in energy consumption from the use of vacuum systems.

When maintenance is carried out, additional waste may occur.

##### Operational data

Depending on the particular individual case related measure/technique.

##### Applicability

The techniques can, in principle, be carried out in the cement industry.

**Economics**

Depending on the particular individual case related measure/technique.

**Driving force for implementation**

Legal requirements.

Local conditions.

Health and safety requirements for the workplace.

**Example plants and reference literature**

Cement plants in the EU-27.

[76, Germany, 2006], [168, TWG CLM, 2007].

**1.4.4.2 Techniques for bulk storage areas and stockpiles****Description and achieved environmental benefits**

In order to reduce diffuse dust emissions from storage locations of dusty mineral raw materials or fuels into the open air, such stockpiles or bulk storage areas can be covered or enclosed with screening, walling or an enclosure consisting of vertical greenery (artificial or natural wind barriers for open pile wind protection).

Some techniques for diffuse dust abatement are:

- open pile wind protection:
  - outdoor storage piles of dusty materials should be avoided, but when they do exist it is possible to reduce diffuse dust by using properly designed wind barriers
- water spray and chemical dust suppressors:
  - when the point source of diffuse dust is well localised, a water spray injection system can be installed. The humidification of dust particles aids agglomeration and so helps dust settle. A wide variety of agents is also available to improve the overall efficiency of the water spray
- paving, road wetting and housekeeping:
  - areas used by lorries should be paved when possible and the surface should be kept as clean as possible. Wetting the roads can reduce diffuse dust emissions, especially during dry weather. They also can be cleaned with road sweepers. Good housekeeping practices should be used in order to keep diffuse dust emissions to a minimum
- humidification of stockpiles:
  - diffuse dust emissions at stockpiles can be reduced by using sufficient humidification of the charging and discharging points, and by using conveyor belts with adjustable heights.

If diffuse dust emissions at the charging or discharging points of storage sites cannot be avoided, they can be reduced by matching the discharge height to the varying height of the heap, if possible automatically, or by reduction of the unloading velocity.

**Cross-media effects**

The water consumption increases when keeping locations wet.

There is an increase in energy consumption from the use of vacuum systems and water spray systems.

When maintenance is carried out, additional waste may occur.

**Operational data**

Depending on particular individual case related measure/technique.

**Applicability**

The techniques can, in principle, be carried out in the cement industry.

### **Economics**

Depending on particular individual case related measure/technique.

### **Driving force for implementation**

Legal requirements.

Local conditions.

Health and safety requirements for the workplace.

### **Example plants and reference literature**

Cement plants in the EU-27, Gador plant in Spain.

[9, CEMBUREAU, 1997 November], [45, Schorcht, 2006], [168, TWG CLM, 2007], [182, TWG CLM, 2008].

#### **1.4.4.3 Reduction of channelled dust emissions**

There are different main point sources of dust emissions from cement plants. These are kiln systems, clinker coolers and mills for raw material, cement and coal as well as subsidiary processes. A major part of the fine dust (PM<sub>10</sub>, PM<sub>2.5</sub>) can be reduced by reduction of the total dust load and by using high efficiency dedusting systems. Various dedusting devices have been used in the past for these duties but in 2007 the main dry flue-gas filter systems used for dust reduction are fabric filters, electrostatic precipitators (ESPs) or a combination of both, the so-called hybrid filters. In some cases, the use of sintered lamellar filters is reported; however, not for cement kiln applications. Examples of system types of ESPs, fabric filters and the amount of filter dust and dust extraction are shown in Table 1.24. Diffuse dust emissions from the handling and storage of materials, and the crushing and grinding of raw materials and fuels can also be significant (see Sections 1.4.4.1 and 1.4.4.2). Table 1.31 shows a summary of operational data which are available within the text of this section. This table gives an overview and should be read in conjunction with the corresponding sections and paragraphs below.

ESPs and fabric filters both have their advantages and disadvantages. Both have a very high dedusting efficiency during normal operation. During special conditions, such as high CO concentration, kiln start-up, kiln shutdown or switching from compound operation (raw mill on) to direct operation (raw mill off), the efficiency of ESPs can be significantly reduced while the efficiency of fabric filters is less affected. However, whilst using ESPs, the effects of CO trips can be minimised as per Section 6.2.6. ESPs and fabric filters have a high overall efficiency of higher than 99 % particulate retention and both depend on particle size. Both types of filter systems have to be properly (periodically) maintained to maintain adequate efficiency. Depending upon the exhaust gas temperature, different types of filter media have to be used. A disadvantage of fabric filters is that used filter bags are waste and have to be disposed of according to national regulations [9, CEMBUREAU, 1997 November], [103, CEMBUREAU, 2006], [168, TWG CLM, 2007], [182, TWG CLM, 2008].

Measure/technique	Applicability	Emissions data <sup>(5)</sup>		Cost <sup>(3)</sup>	
		mg/Nm <sup>3</sup> ( <sup>1</sup> )	kg/tonne( <sup>2</sup> )	Investment	Operating
				million EUR	EUR/t clinker
Electrostatic precipitators	All kiln systems, clinker coolers, cement mills	<10 – <20	0.02 – 0.05	2.1 – 6.0	0.1 – 0.2
		<10 – <20	0.02 – 0.05	0.8 – 1.2	0.09 – 0.18
		<10	0.02	0.8 – 1.2	0.09 – 0.18
Fabric filters	All kiln systems, clinker coolers, mills (raw material, cement, coal mills)	<5	0.01	2.1 – 6.0 <sup>(4)</sup>	0.15 – 0.35
		<5	0.01	1.0 – 1.4 <sup>(4)</sup>	0.1 – 0.15
		<10	0.02	0.3 – 0.5 <sup>(4)</sup>	0.03 – 0.04
Hybrid filters	All kiln systems, clinker coolers, cement mills	<10 – 20	0.02 – 0.05		
Diffuse dust abatement	All plants	-	-	-	-

(<sup>1</sup>) For kiln systems normally referring to daily averages, dry gas, 273 K, 101.3 kPa and 10 % O<sub>2</sub>  
(<sup>2</sup>) kg/tonne clinker: based on 2300 m<sup>3</sup>/tonne clinker  
(<sup>3</sup>) Cost for reducing the emissions to 10 – 30 mg/Nm<sup>3</sup>, normally referring to a kiln capacity of 3000 tonne clinker per day and initial emissions of up to 500 g dust/Nm<sup>3</sup>  
(<sup>4</sup>) Depends on the filter medium used, see Table 1.32, by separation efficiencies of higher than 99.9 %  
(<sup>5</sup>) Emissions data can be found in the corresponding paragraph of this section

**Table 1.31: Overview of techniques for controlling dust in the cement production process**

Further examples of system types of ESPs and fabric filters along with the amount of filter dust and dust extraction are shown in Section 1.3.4.1.1 and Table 1.24. These values represent typical ranges and the overview also allows an estimation of filter dust and dust extraction where applicable [76, Germany, 2006].

#### 1.4.4.3.1 Electrostatic precipitators (ESPs)

##### Description and achieved environmental benefits

Electrostatic precipitators (ESPs) generate an electrostatic field across the path of particulate matter in the air stream. The particles become negatively charged and migrate towards positively charged collection plates. The collection plates are rapped or vibrated periodically, dislodging the material so that it falls into collection hoppers below. It is important that ESP rapping cycles are optimised to minimise particulate re-entrainment and thereby minimise the potential to affect plume visibility. ESPs are characterised by their ability to operate under conditions of high temperatures (up to approximately 400 °C) and high humidity.

The performance of an ESP is dependent on a variety of operational parameters, such as:

- moisture content of the gas
- flue-gas chemistry
- flue-gas flowrate
- particle size distribution and chemical make-up
- particulate electrical resistivity
- particulate loading rate
- gas temperature
- start and stop operation
- strength of the electric field
- area and shape of the electrodes
- SO<sub>2</sub> concentration
- moisture content
- transition phases of different operating conditions.

In particular, performance can be impaired by the build-up of material forming an insulating layer on the electrodes and so reducing the electric field. This can happen if there are high chlorine and sulphur inputs to the kiln process, forming alkali metal chlorides and sulphates. The alkali metal chlorides can form sub-micron dust (0.1 – 1 µm) and have high specific dust resistivity (of between  $10^{12}$  –  $10^{13}$  Ω/cm) forming insulating layers on the electrodes and so leading to problems in dust removal.

Problems of high dust resistivity can partly be solved by water injection in evaporation coolers. Another way of solving the problem is to use fabric filters.

### **Cross-media effects**

Alkali metal chlorides and sulphates with sub-micron dust particles can be formed.

Explosion risks arise at high CO concentrations (see Section 1.4.5.3).

Electricity energy consumption increases with increased removal efficiency.

When maintenance is carried out, additional waste may occur.

Dust can be re-used.

### **Operational data**

Sufficiently dimensioned ESPs, together with good air conditioning and an optimised ESP cleaning regime, can reduce levels down to 5 – 15 mg/Nm<sup>3</sup> as the monthly average (dry gas, 273 K, 10 % O<sub>2</sub>). The designed collection efficiency of the particulate is higher than 99.99 %, and therefore emissions of only a few mg/Nm<sup>3</sup> can be achieved. ESPs are very efficient devices for collecting ultrafine particles (<0.5 µm), providing the particles have the ability to agglomerate. ESPs are of a heavy-duty design leading to high applicability and also relatively insensitive to disturbances in the process. Existing ESP installations can often be upgraded without the need for total replacement thereby limiting costs. This may be done by fitting more modern electrodes or installing automatic voltage control on older installations. In addition, it may be possible to improve the gas passage through the ESP or add supplementary stages. In 2006, many well designed and well maintained ESPs achieved dust emission levels of <10 mg/Nm<sup>3</sup> (daily average value). An ESP with emissions of less than 10 mg/Nm<sup>3</sup> can be built with the application of the most modern process control, optimal high voltage supplies, proper sizing and an appropriate number of electrical fields.

Besides dust, the ESP also removes substances that adsorb to the dust particles, such as dioxins and metals if present.

The size and electric power consumption of ESPs rise exponentially with decreasing clean gas dust content. An ESP depends on defined raw gas conditions, such as temperature and humidity, for optimum operation. The lifetime of an ESP can be several decades, providing all recommended maintenance is properly carried out. Some parts, such as hammers and bearings, need regular replacement after a few years of operation as part of routine maintenance.

### **Applicability**

Because of their high efficiency, low pressure loss, high availability and energy efficiency, electrostatic precipitators became successfully established for dust collection from rotary kiln exhaust gas and clinker cooler exhaust gas. The ESP can be used in almost every cement kiln application for the collection of dust from kiln exhaust gas, bypass gas dust or the exit air from grate coolers.

The available literature indicates that there are no restrictions on the applicability of ESPs to the various types of processes used in the cement industry. ESPs are, however, not often chosen for cement mill dedusting because of the investment costs and the efficiency (relatively high emissions) during start-ups and shutdowns.

ESPs are characterised by their ability to operate under conditions of high temperatures (up to approximately 400 °C) and high humidity. The major disadvantages of this measure/technique are their decreased efficiency with an insulating layer and a build-up of material that may be

generated with high chlorine and sulphur inputs. For the overall performance of ESPs, it is important to avoid CO trips (see Sections 1.2.5.6.1, 1.4.5.3 and 6.2.6).

In some cases, ESPs will have to be shut down during elevated CO levels in the flue-gases for safety reasons (CO trips) (see also Sections 1.3.4.1.1, 1.4.3.1, 1.4.5.3 and 6.2.6).

### **Economics**

In 2000, the investment cost for a new ESP for a kiln with a capacity of 3000 tonne clinker/day, initial emission levels of up to 500 g/Nm<sup>3</sup> and a clean gas dust content of 10 – 50 mg/Nm<sup>3</sup> was about EUR 1.5 – 3.8 million, and can be an extra EUR 0.6 – 0.8 million for the conditioning tower and filter fan if required. The operating cost for the same kiln ESP was about EUR 0.1 – 0.2 per tonne of clinker. For a clinker cooler for a kiln capacity of 3000 tonne clinker/day, initial emission levels of up to 20 g/Nm<sup>3</sup> and a clean gas dust content of 10 – 50 mg/Nm<sup>3</sup>, and a cement ball mill with a capacity of 160 tonne cement/hour, initial emission levels of up to 300 g/Nm<sup>3</sup> and a clean gas dust content of 10 – 50 mg/Nm<sup>3</sup>, the investment cost for an ESP was about EUR 0.8 – 1.2 million and the operating cost was EUR 0.09 – 0.18 per tonne of clinker.

In 2006, the investment costs were reported to be in a range from EUR 4.5 million to 6 million for dedusting the kiln exhaust gas (kiln: 3000 t/d). The wide range depends on local manufacturing costs, erection costs (which can vary significantly) and the size of the kiln and the ESP (which is a function of the efficiency). Operational and maintenance costs are normally low. The difference depends, to a great extent, on the local evaluation of the power consumption and maintenance costs (see also Section 1.3.4.1.1, Table 1.24) [76, Germany, 2006].

See also Section 1.4.8.1 and Table 1.39 where example cost data for dust abatement techniques are shown.

### **Driving force for implementation**

Legal requirements.

Health and safety requirements for the workplace.

Local conditions.

### **Example plants and reference literature**

Cement plants in the EU-27.

[3, Austria, 1997], [9, CEMBUREAU, 1997 November], [10, Cementa AB/Hagström, 1994], [12, Netherlands, 1997], [27, University of Karlsruhe, 1996], [76, Germany, 2006], [86, EURITS, 2006], [103, CEMBUREAU, 2006], [168, TWG CLM, 2007], [182, TWG CLM, 2008].

#### **1.4.4.3.2 Fabric filters**

##### **Description and achieved environmental benefits**

Fabric filters are efficient dust collectors. The basic principle of fabric filtration is to use a fabric membrane which is permeable to gas but which will retain the dust. Basically, the filter medium is arranged geometrically; however, a distinction is made between cylindrical filter bags (vertically hanging) as shown in Figure 1.60 and filter pockets that are usually installed horizontally. Initially, dust is deposited both on the surface fibres and within the depth of the fabric, but as the surface layer builds up the dust itself becomes the dominating filter medium. Off-gas can flow either from the inside of the bag outwards or vice versa. As the dust cake thickens, the resistance to gas flow increases. Periodic cleaning of the filter medium is therefore necessary to control the gas pressure drop across the filter. Depending on the type of cleaning, the most common cleaning methods include compressed air pulsing (pulse jet filters) reverse airflow, mechanical rapping or shaking and vibration. The fabric filter should have multiple compartments which can be individually isolated in case of bag failure and there should be sufficient of these to allow adequate performance to be maintained if a compartment is taken off

line. There should be ‘burst bag detectors’ in each compartment to indicate the need for maintenance when this happens.

Filter bags are available in a range of woven and non-woven fabrics. High temperature applications will result in the need for more exotic fabric types than are ‘normally’ supplied. However, a good range of these is available. Modern synthetic fabrics can operate in quite high temperatures of up to 280 °C. The key characteristics of different fabric filters along with costs schedules are shown in Table 1.32.



Source: [82, CEMEX Rugby UK, 2006]

**Figure 1.60:** Example of a fabric filter and filter material used in a cement plant in the UK

### **Cross-media effects**

Increased electrical energy use with increased removal efficiency.

Increased compressed air for the cleaning cycle.

When maintenance is carried out, additional waste may occur.

By using sintered lamella filters, noise emissions may occur.

### **Operational data**

Modern synthetic fabrics include materials which can operate in quite high temperatures of up to 280 °C. Typical values of filter rating are between 0.5 and 2.0 m/min. The separation efficiency can be higher than 99.9 %, and therefore emissions of less than 5 mg/Nm<sup>3</sup> can be achieved by well designed and well maintained fabric filters (dry gas, 273 K, 10 % O<sub>2</sub>). Besides dust, the fabric filter also removes substances that adsorb to the dust particles, such as dioxins and metals if present.

The key characteristics of different fabric filters along with costs schedules are shown in Table 1.32:



Technical application of fibres in cement manufacturing processes and cement plants											
Types of fibres (no brand nomination)		Temperature (°C)		Resistance to acids	Resistance to alkalis (most)	Hydrolysis/hot moisture	Oxidation/oxygen >13 %	Abrasion resistance for cement plant application	Filtration efficiency without surface treatment	Chemical or mechanical surface treatment to improve filtration and economics	Relative costs per area unit installed
		Nominal	Peak								
Cotton		80	80	Poor	Good			Good	Very good		Low
Polypropylene	PP	90	100	Excellent	Excellent	Excellent	Excellent	Excellent	Good	Not needed for applications	Low
Wool				Fair	Poor				Very good		Low
Polyester	PES	150	160	Low	Fair	Poor	Excellent	Excellent	Good	Yes for process, no for silos of diffuse dust collectors	Low
Polyacrylonitrile copolymer	PAN	110	120	Good	Fair	Excellent	Excellent	Good	Good		Low
Polyacrylonitrile hymopolymer >95 %		125	135						Good		Low
Nylon			205	Poor to fair	Excellent			Excellent	Excellent		
Aramide (meta)/aromatic polyamide	AR/PA	180	200	Fair	Good	Fair	Excellent	Good	Good	Yes for process gas treatment applications	Medium
Polyvelyenesulphide	PPS	180	200	Excellent	Excellent	Good	Poor	Good	Good		Medium
Polyimide	PI	180	240	Fair	Fair	Fair	Good	Good	Excellent	Not necessary due to fibre structure	High
Glass fibre woven	GF	280	280	Good, except HF	Excellent	Excellent	Excellent	Poor	Fair	Low filtration velocity recommended	Medium
Glass fibre with ePTFE membrane (expanded)	GF+Mem.	260	280					Fair	Superior		Included due to membrane
Polytetrafluoroethylene	PTFE	250	260	Superior	Superior	Superior	Superior	Fair	Poor	Highly recommended	Very high
Table shows average costs for medium to large scale purchasing, typical for cement plants. Costs will vary due to energy and filter medium.											
Costs schedule	Low	up to EUR 10 per m <sup>2</sup> filter cloth, ex-works, packed, not installed									
	Medium	from EUR 10 to 20 per m <sup>2</sup> filter cloth, ex-works, packed, not installed									
	High	from EUR 20 to 40 per m <sup>2</sup> filter cloth, ex-works, packed, not installed									
	Very high	above EUR 40 per m <sup>2</sup> filter cloth, ex-works, packed, not installed									
Source: [86, EURITS, 2006], [81, Castle Cement UK, 2006] [134, CEMBUREAU/Federhen, 2007]											

**Table 1.32: Key characteristics of different filter media and costs schedules**

### Applicability

This measure/technique can, in principle, be carried out in the cement industry and can be used in almost every cement kiln application for the collection of dust from kiln exhaust gas, bypass gas dust or the exhaust air from grate coolers. The available literature indicates that there are no restrictions on the applicability of fabric filters to the various types of processes used in the cement industry. However, moisture and temperature have to be considered.

The performance of fabric filters is mainly influenced by different parameters, such as compatibility of the filter medium with the characteristics of the flue-gas and the dust, suitable properties for thermal, physical and chemical resistance, such as hydrolysis, acid, alkali, and oxidation and process temperature. Important characteristics of a filter are the size of the filtering surface, the separation efficiency and the resistance to filtration, the so-called 'filter differential pressure'. This value depends on the properties of the filter medium and dust. The basic parameter for the design of a filter is the volume flow. Therefore, the filter rating has to be determined, which depends on the type, the amount and the properties of the dust and the gas.

Service life, energy and maintenance requirements of fabric filters are influenced by thermal and mechanical stress. Gas flowrate, dust cake thickness, porosity and cleaning cycle can affect the removal efficiency. The improvements, such as reduced pressure drop across the medium, quick detection of potential leaks with continuous monitoring and by detectors, and cleaning systems, result in longer filter life and lower costs. Furthermore, cleaning cycles and cleaning methods of the filter material can affect the efficiency of the cleaning system. Tests show that, e.g. by using a low pressure pulse jet cleaning system the efficiency can be increased while at the same time minimising the power consumption and having great advantages with respect to noise emissions. This system can be used for dedusting exhaust gas from rotary kilns, but also for dedusting the alkali bypass, clinker cooler, mills and classifiers.

In combination with fabric filters, cyclones are applicable to clinker cooler systems. In a cyclone/centrifugal separator, the dust particles to be eliminated from an off-gas stream are forced out against the outer wall of the unit by centrifugal action and then eliminated through an aperture at the bottom of the unit. Centrifugal forces can be developed by directing the gas flow in a downward spiral motion through a cylindrical vessel (cyclonic separators) or by a rotating impeller fitted in the unit (mechanical centrifugal separators). In the cement industry, cyclones are combined with an air heat exchanger for temperature reduction and a fabric filter system (baghouse filter) for dust removal from, e.g. cooling exhaust gases. A cyclone can reduce the dust concentration by 70 %. In combination with an air heat exchanger and a baghouse filter, high cleaning efficiencies of up to 99.99 % are achievable along with low emission values of 5 – 7 mg/Nm<sup>3</sup>. However, sufficient space for construction is necessary because of the great dimensions of the cyclone (e.g. 25 m length, 6.4 m height, 6.4 m diameter) and the combined heat exchanger. Furthermore, additional electrical energy is used while collection and recovery of separated dust may lead to reduced raw material consumption [148, Reitemeier, 2005].

Sintered lamella filters are sometimes used as filter media; however, not for cement kiln applications. Practical experience has shown that because of their fully sintered and compact form and the special PTFE coating, the sintered lamellae are very robust with a low maintenance requirement. The main advantages of this modern filter medium are a very high dust cleaning efficiency from off-gases in combination with a low pressure drops as well as a high resistance to abrasive wear. The filter geometry ensures a very compact structure and the filter can be installed under very constricted conditions. Noise emissions can be minimised by using a compact noise protection hood [144, Adlhoch, 1996].

### Economics

The investment required to fit a new fabric filter to a kiln with a capacity of 3000 tonne clinker/day, with an initial emission level of up to 500 g/Nm<sup>3</sup> and a clean gas dust content of 10 - 50 mg/Nm<sup>3</sup> is about EUR 1.5 million – 6 million, and an extra EUR 0.6 million – 0.8 million are needed for the conditioning tower and filter fan if required. For separation efficiencies of higher than 99.9 % for dedusting the kiln exhaust gases, the investment costs for

fabric filter plants (baghouse filters) can range between EUR 4 million to 8 million depending on the type and the number of filter bags used. Maintenance may appear to be low at costs of up to EUR 10 per Nm<sup>2</sup> for a filter bag as shown in Table 1.32. However, kiln exhaust filters can contain many thousands of bags and so a very large filter cloth area corresponds to many thousand Nm<sup>2</sup>. Operational and maintenance costs depend, to a great extent, on the local evaluation of the power consumption and maintenance costs (see also Section 1.3.4.1.1 and Table 1.24).

Conditioning towers are generally applied to achieve applicable temperatures for fabric filter operations. The operating costs for the same kiln fabric filter are about EUR 0.10 – 0.35 per tonne clinker. A pulse jet fabric filter with an air to air heat exchanger and a filter fan for a grate clinker cooler for a kiln capacity of 3000 tonne clinker/day, with an initial emission level of up to 20 g/Nm<sup>3</sup> and a clean gas dust content of 10 – 50 mg/Nm<sup>3</sup> costs about EUR 1.0 million – 1.4 million and the operating cost is about EUR 0.10 – 0.15 per tonne clinker. For a cement ball mill with a capacity of 160 tonne cement/hour, and an initial emission level of up to 300 g/Nm<sup>3</sup> and clean gas dust content of 10 – 50 mg/Nm<sup>3</sup>, the investment cost for a pulse jet fabric filter is about EUR 0.3 million – 0.5 million including a filter fan, and the operating cost is EUR 0.03 – 0.04 per tonne clinker [9, CEMBUREAU, 1997 November].

To optimise operating costs, different cement plants have installed optimised pressure pulse jet cleaning systems. The filter area loading, the filter differential pressure and the cleaning system are the three main important factors affecting the cost reduction for fabric filters. Because of the mutual interaction of these parameters, the aim is to achieve the highest possible air:cloth ratio, the lowest possible differential pressure and the lowest possible cleaning pressure. Total cost reductions (investment and operating costs) of between 12 and 25 % have been reported.

See also Table 1.32 above where the key characteristics for different fabric filters along with costs schedules are shown. Furthermore, see also Section 1.4.8.1 and Table 1.39 where example cost data for dust abatement techniques are shown.

#### **Driving force for implementation**

Legal requirements.

Local conditions.

Health and safety requirements for the workplace.

#### **Example plants and reference literature**

Cement plants in the EU-27; cement plant Dudfield, South Africa (use of cyclone in combination with an air-air heat exchanger and fabric filter plants (baghouse filter), cement plant in Germany (use of sintered lamella filters).

[3, Austria, 1997], [9, CEMBUREAU, 1997 November], [12, Netherlands, 1997], [76, Germany, 2006], [81, Castle Cement UK, 2006], [86, EURITS, 2006], [103, CEMBUREAU, 2006], [134, CEMBUREAU/Federhen, 2007], [144, Adlhoch, 1996], [145, Leibinger/Köberl, 2001], [146, Leibinger/Neumann, 2003], [147, Marmor/Petzold, 2006], [148, Reitemeier, 2005], [168, TWG CLM, 2007], [182, TWG CLM, 2008].

## 1.4.4.3.3 Hybrid filters

**Description and achieved environmental benefits**

Hybrid filters are the combination of ESPs and fabric filters in the same device. They generally result from the conversion of existing ESPs. They allow the partial re-use of the old equipment. The principle of a hybrid filter is shown in Figure 1.61.

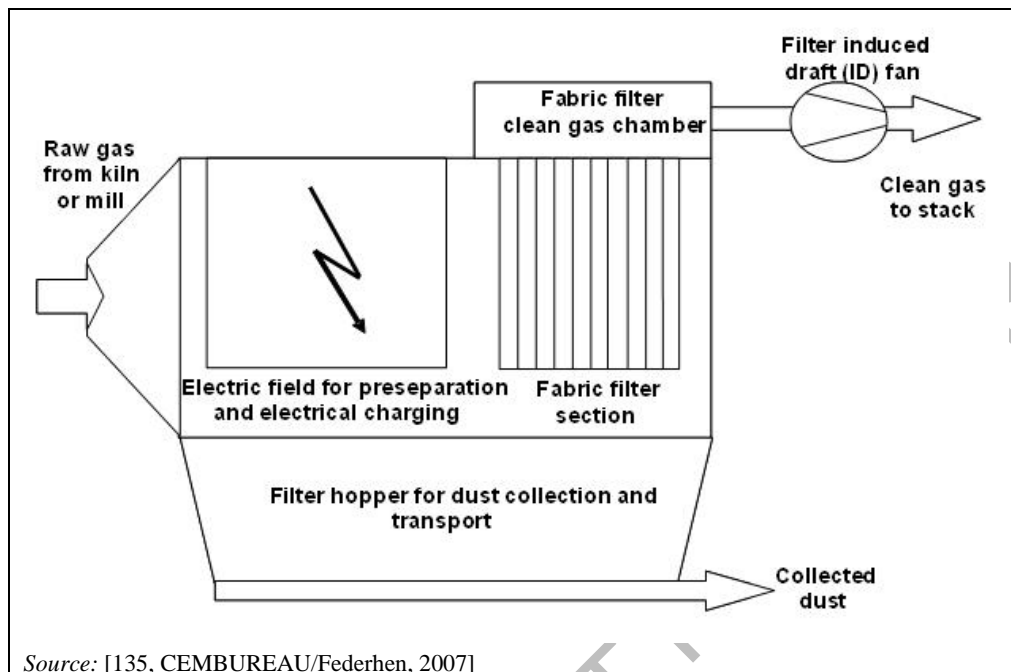


Figure 1.61: Hybrid filter for dust collection

**Cross-media effects**

Explosion risks arise in cases of high CO concentrations (CO trips).

When maintenance is carried out, additional waste may occur.

Reduced water use compared to ESPs.

Reduced amount of process losses/waste compared to fabric filters.

**Operational data**

Dust emissions figures from hybrid filters installed on kilns are reported to range from <math><10</math> to <math>20</math> mg/Nm<sup>3</sup> as a daily average value (see Section 1.3.4.1.1). However, dust emissions of less than 10 mg/Nm<sup>3</sup> are achieved by well maintained fabric filters (see Section 1.4.4.3.2).

**Applicability**

The techniques are, in principle, applicable in the cement industry.

**Economics**

See also Section 1.4.8.1 and Table 1.39 where example cost data for dust abatement techniques are shown.

**Driving force for implementation**

Legal requirements.

Local conditions.

**Example plants and reference literature**

Sagunto plant and Gador plant in Spain, cement plants in the EU-27.

[86, EURITS, 2006], [103, CEMBUREAU, 2006], [135, CEMBUREAU/Federhen, 2007], [168, TWG CLM, 2007], [182, TWG CLM, 2008].

## 1.4.5 Gaseous compounds

### 1.4.5.1 Reduction of NO<sub>x</sub> emissions

For the reduction or controlling of NO<sub>x</sub> emissions, one or a combination of primary and/or process-integrated and secondary techniques are considered suitable. Primary techniques are:

- flame cooling, e.g. high water content, liquid/solid wastes
- low NO<sub>x</sub> burners
- mid kiln firing
- addition of mineralisers to improve the burnability of the raw meal (mineralised clinker)
- staged combustion (conventional or waste fuels) also in combination with precalciner and the use of optimised fuel mix
- process optimisation.

Furthermore, secondary techniques can be used for NO<sub>x</sub> reduction, such as:

- SNCR technique and high efficiency SNCR technique
- SCR technique.

For environmental/safety and economic reasons, the NO<sub>x</sub> reduction process should preferably start with the implementation of general primary techniques, such as process-integrated and control techniques, staged combustion and flame cooling, improved firing technique, optimised cooler connections and fuel selection and these also reduce NO<sub>x</sub> emissions (e.g. use of selected waste). Some well optimised preheater kiln systems and preheater/precalciner kiln systems are achieving less than 500 mg NO<sub>x</sub>/Nm<sup>3</sup> with either primary techniques only or combined with staged combustion as well as with a combination of fuel mix use and process-integrated techniques. Raw material qualities, e.g. burnability of the raw mixes as well as fuel mixes and kiln system designs, are among the reasons for not being able to achieve this level. However, in many cement plants in the EU-27 (42 % in 2008), the SNCR technique is used in combination with primary techniques for NO<sub>x</sub> reduction, as shown in Table 1.33 [76, Germany, 2006], [85, CEMBUREAU, 2006]. Furthermore, two cement plants use the SCR technique (high dust).

Table 1.33 presents the number of full scale installations known in the EU-27 and the EU-23+ countries (see Glossary) using abatement techniques to reduce NO<sub>x</sub> emissions.

Techniques for reducing/controlling NO <sub>x</sub> emissions						
Country		Flame cooling	Mineralised clinker	Staged combustion	SNCR	SCR
Belgium	BE	2			2	
Bulgaria	BG					
Czech Republic	CZ				2 <sup>(3)</sup>	
Denmark	DK		2		1	
Germany	DE			7	33	1 <sup>(1)</sup>
Estonia	EE					
Greece	EL			1		
Spain	ES		4	2	3 + 5 (pilot phase)	
France	FR	2		7	14 + 4 <sup>(6)</sup>	
Ireland	IE			1	2 <sup>(2)</sup>	
Italy	IT	2		7	16 <sup>(1)</sup>	1 <sup>(2)</sup>
Cyprus	CY					
Latvia	LV					
Lithuania	LT					
Luxembourg <sup>(1)</sup>	LU					
Hungary	HU				3	
Malta	MT					
Netherlands	NL				1	
Austria	AT	3		2	8 <sup>(3)</sup>	
Poland	PL			9		
Portugal	PT	6			4	
Rumania	RO					
Slovenia	SI					
Slovakia	SK					
Finland	FI				2	
Sweden	SE				3	
United Kingdom	UK			1	9 <sup>(4)</sup>	
Switzerland	CH	2	1	1	4	
Norway	NO					
Turkey	TR	1	1	2		

(<sup>1</sup>) Reported to be in operation but reporting still lacking  
(<sup>2</sup>) One plant has been in operation since the middle of 2006, second plant since 2007  
(<sup>3</sup>) Scheduled for 2008  
(<sup>4</sup>) Put into operation in 2007  
(<sup>5</sup>) Scheduled for commissioning in 2007  
(<sup>6</sup>) Scheduled for 2008  
Source: [85, CEMBUREAU, 2006]

**Table 1.33: Techniques for reducing NO<sub>x</sub> emissions used in the cement industries in the EU-27 and EU-23+ countries**

Table 1.34 gives an overview of the techniques that have a positive effect on (but not necessarily cumulative), i.e. to reduce, the emissions of NO<sub>x</sub> arising during the manufacture of cement. This table is a summary of operational data which are available within the text of this section and should be read in conjunction with the corresponding paragraphs in the following sections.

Measure/technique	Kiln systems applicability	Reduction efficiency (%)	Emissions data <sup>(15)</sup>		Cost data <sup>(3)</sup>	
			mg/Nm <sup>3</sup> <sup>(1)</sup>	kg/t <sup>(2)</sup>	Investment (EUR million)	Operating EUR/t clinker
Flame cooling <sup>(5)</sup>	All	0 – 35	Primary reduced to <500 – 1000 <sup>(9)</sup>	1.15 – 2.3	Up to 0.2	Up to 0.5
Low NO <sub>x</sub> burner	All	0 – 35	500 – 1000	1.15 – 2.3	Up to 0.45	0.07
Primary techniques EGTEI 2003 <sup>(4)</sup>	All	25	1400 reduced to 1050	2.4	0.25	0.056
Mid-kiln firing	Long	20 – 40	No Information	-	0.8 – 1.7	No information
Mineralised clinker	All	10 – 15	No information	-	No information	No information
Staged combustion	Precalciner	10 – 50	<450 – 1000 <sup>(9)</sup>	1.04 – 2.3	0.1 – 2	No information
	Preheater				1 – 4	
SNCR <sup>(4)</sup> <sup>(5)</sup> <sup>(6)</sup> <sup>(12)</sup>	Preheater and precalciner	30 to 90 <sup>(10)</sup>	<200 <sup>(10,11)</sup> – 500 <sup>(14)</sup>	0.4 – 1.15	0.5 – 1.2	0.1 – 1.7
	Grate preheater	35	<500 <sup>(16)</sup> – 800 <sup>(5,6)</sup>	1.15 – 1.84	0.5	0.84
SCR <sup>(7)</sup>	Possibly all, preheater and precalciner	43 <sup>(13)</sup> – 95	<200 <sup>(8)</sup> – 500	0.23 – 1.15	2.2 – 4.5	0.33 – 3.0

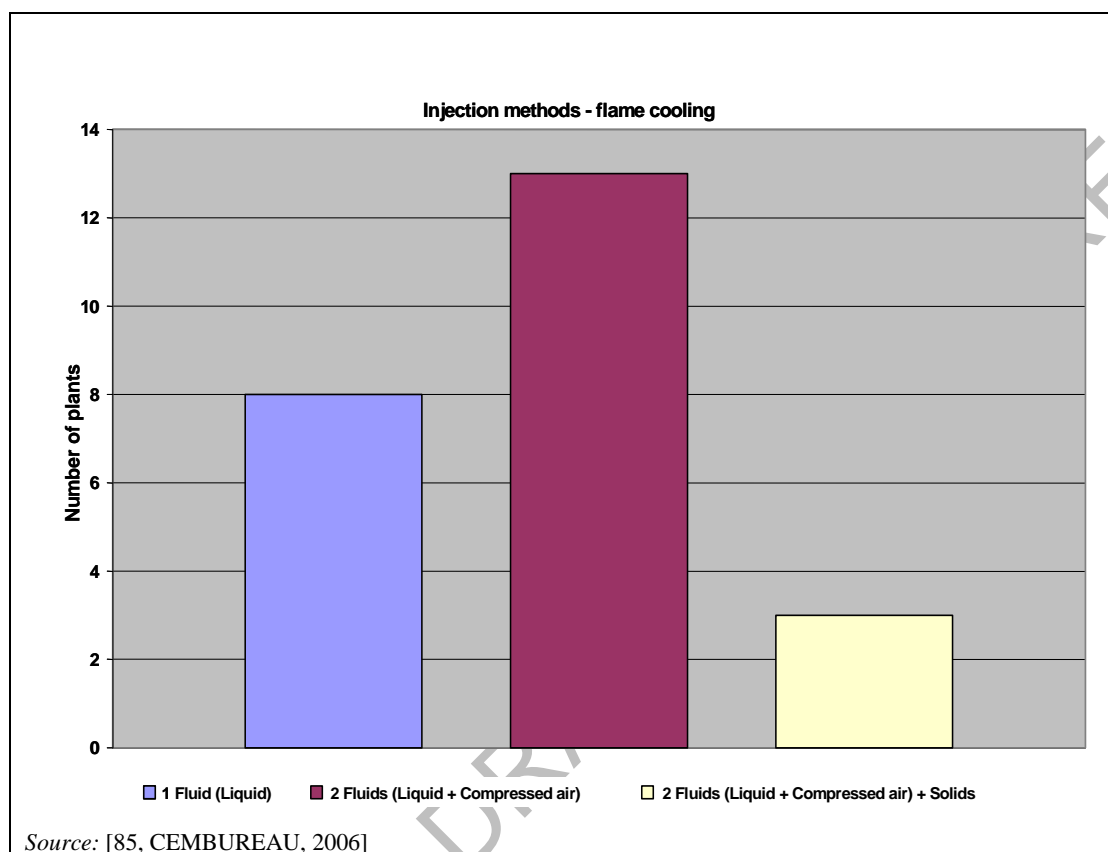
(<sup>1</sup>) Normally refers to daily averages, dry gas, 273 K, 101.3 kPa and 10 % O<sub>2</sub>  
(<sup>2</sup>) kg/tonne clinker: based on 2300 m<sup>3</sup>/tonne clinker  
(<sup>3</sup>) Normally refers to a kiln capacity of 3000 tonne clinker/day and initial emissions of up to 2000 mg NO<sub>x</sub>/Nm<sup>3</sup>  
(<sup>4</sup>) EGTEI costs estimation for a kiln capacity of 1100 t/d in 2000  
(<sup>5</sup>) Experiment in France in co-operation with the Environment Ministry, ADEME and ATILH in 2000 (issue 2003)  
(<sup>6</sup>) CEMBUREAU contribution on NO<sub>x</sub> abatement 2006, yearly average values, see Section 1.3.4.2 and Figure 1.29  
(<sup>7</sup>) Germany and Italy, see also Table 1.35 and Table 6.26, cost data based on a kiln capacity of 1500 m<sup>3</sup>/tonne clinker  
(<sup>8</sup>) Pilot test results from Germany, Italy and Sweden and test results in 2007 (200 mg/Nm<sup>3</sup>) from an Italian cement plant using SCR; in 1997, two suppliers in Europe offered full scale SCR to the cement industry with guaranteed performance levels of 100 – 200 mg/Nm<sup>3</sup>  
(<sup>9</sup>) Test results from French cement plant (project 10), precalciner kiln, initial NO<sub>x</sub> level 1000 mg/Nm<sup>3</sup>; achieved NO<sub>x</sub> level of 800 mg/Nm<sup>3</sup>  
(<sup>10</sup>) Swedish cement plants, yearly average value, initial NO<sub>x</sub> level 800 – 1000 mg/Nm<sup>3</sup>, ammonia slip 5 – 20 mg/Nm<sup>3</sup> (see Section 6.2.4.1), high efficiency SNCR, the ammonia slip has to be considered  
(<sup>11</sup>) Germany: 200 – 350 mg/Nm<sup>3</sup> as daily average value, the ammonia slip has to be considered  
(<sup>12</sup>) The lower NO<sub>x</sub> emissions range may result in higher NH<sub>3</sub> emissions (ammonia slip), depending on the NO<sub>x</sub> level in the raw gas stream  
(<sup>13</sup>) Results from pilot test and long term operation of the demonstration plant, see Table 1.35  
(<sup>14</sup>) In combination with process integrated techniques; initial NO<sub>x</sub> level 1200 mg/Nm<sup>3</sup>; the French Cement Industry Guide to NO<sub>x</sub> emissions reduction techniques, France/ADEME/MEDD  
(<sup>15</sup>) Emissions data can be found in the corresponding paragraph of this section  
(<sup>16</sup>) [92, Austria, 2006], [185, Hackl und Mauschwitz, 2003], see also BAT 19  
Source: [12, Netherlands, 1997], [76, Germany, 2006], [85, CEMBUREAU, 2006], [92, Austria, 2006], [101, France/ADEME/MEDD, 2002], [114, Sweden, 2006], [140, Italy, 2007], [141, Leibacher/Bellin/Linero, 2007], [173, Germany, 2007], [182, TWG CLM, 2008], [185, Hackl und Mauschwitz, 2003]

**Table 1.34: Techniques for reducing NO<sub>x</sub> emissions occurring in cement manufacturing processes**

## 1.4.5.1.1 Flame cooling

**Description**

The addition of water to the fuel or directly to the flame by using different injection methods, as shown in Figure 1.62, such as injection of one fluid (liquid) or two fluids (liquid and compressed air or solids) or the use of liquid/solid wastes with a high water content reduces the temperature and increases the concentration of hydroxyl radicals. This can have a positive effect on NO<sub>x</sub> reduction in the burning zone.



**Figure 1.62: Injection methods used for flame cooling in cement manufacture in EU-23+ countries**

**Achieved environmental benefits**

Reduction of NO<sub>x</sub> in the burning zone.

Reduction of NO<sub>x</sub> emissions.

**Cross-media effects**

Additional heat may be required to evaporate the water, which causes slightly more CO<sub>2</sub> emissions (approximately 0.1 – 1.5 %) compared to the total CO<sub>2</sub> emissions of the kiln.

Energy efficiency of the kiln firing process decreases.

Water injection can cause kiln operation problems, such as reduced clinker output and may affect the clinker quality.

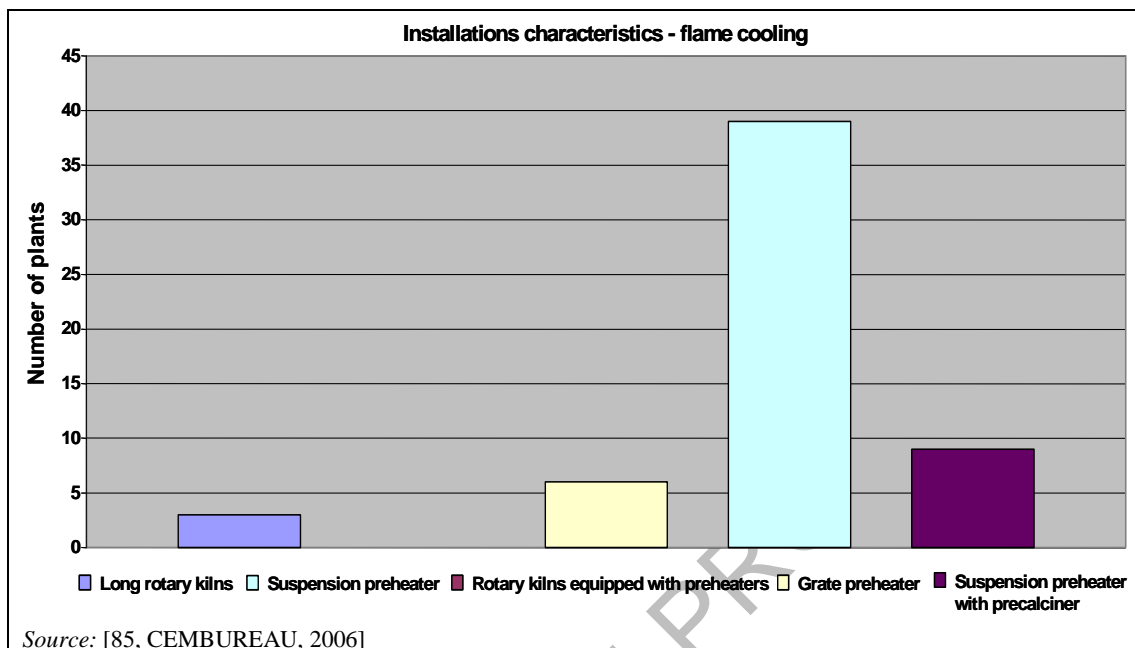
**Operational data**

Reduction rates/efficiencies from 10 – 35 % have been reported. Emissions ranges of <500 – 1000 mg/Nm<sup>3</sup> were reported (yearly average values) (see Section 1.3.4.2, Figure 1.27 and Figure 1.28).



### Applicability

Flame cooling can be applied for all types of kilns used for cement manufacturing. As shown in Figure 1.63, nearly 40 suspension preheater kilns are equipped with flame cooling.



**Figure 1.63: Installation characteristics for flame cooling application in EU-23+ countries**

### Economics

For a kiln capacity of 3000 t/d the investment costs are estimated to be up to EUR 0.2 million and the operating costs up to EUR 0.25 per tonne clinker. Furthermore as shown in Table 1.34, for a reduction efficiency of NO<sub>x</sub> emissions of up to 35 %, investment costs of up to EUR 0.2 million and operating costs of up to EUR 0.5/t clinker were reported.

### Driving force for implementation

Legal requirements.  
Local conditions.

### Example plants and reference literature

Cement plants in the EU-27

[8, CEMBUREAU, 2001], [9, CEMBUREAU, 1997 November], [76, Germany, 2006], [85, CEMBUREAU, 2006], [168, TWG CLM, 2007], [182, TWG CLM, 2008].

#### 1.4.5.1.2 Low NO<sub>x</sub> burners

##### Description and achieved environmental benefits

Designs of low NO<sub>x</sub> burners (indirect firing) vary in detail but essentially the fuel and air are injected into the kiln through concentric tubes. The primary air proportion is reduced to some 6 – 10 % of that required for stoichiometric combustion (typically 10 – 15 % in traditional burners). Axial air is injected at high momentum in the outer channel. The coal may be blown through the centre pipe or the middle channel. A third channel is used for swirl air, its swirl being induced by vanes at, or behind, the outlet of the firing pipe.

The net effect of this burner design is to produce very early ignition, especially of the volatile compounds in the fuel, in an oxygen-deficient atmosphere, and this will tend to reduce the formation of NO<sub>x</sub>.

### Cross-media effects

No issues.

### Operational data

NO<sub>x</sub> reductions of up to 35 % are achievable in successful installations and emission levels of around 500 – 1000 mg/Nm<sup>3</sup> (daily average value) have been reported.

### Applicability

Low NO<sub>x</sub> burners can be applied to all rotary kilns, in the main kiln as well as in the precalciner. However, the application of low NO<sub>x</sub> burners is not always followed by a reduction of NO<sub>x</sub> emissions.

The set-up of the burner has to be optimised. If the initial burner runs on a low percentage of primary air, a low NO<sub>x</sub> burner will have a marginal effect.

### Economics

The investment cost for a new low NO<sub>x</sub> burner is about EUR 150000 to 450000 for a kiln capacity of 3000 tonne clinker/day. However, by replacing a burner by a low NO<sub>x</sub> burner, investment costs can rise up to EUR 600000 and additional work is required for modifying fine coal storage and metering. If the existing firing system uses direct firing, it should be changed to an indirect firing system to allow combustion with a low primary airflow; this will mean an additional investment cost of about EUR 600000 to 800000 for a kiln capacity of 3000 tonne clinker/day.

See also Table 1.34 and Table 1.40 (Section 1.4.8.2) where example costs are shown.

### Driving force for implementation

Legal requirements.

Local conditions.

### Example plants and reference literature

Cement plants in the EU-27.

[9, CEMBUREAU, 1997 November], [12, Netherlands, 1997], [20, Rother, 1996 January,] [76, Germany, 2006], [85, CEMBUREAU, 2006], [101, France/ADEME/MEDD, 2002], [168, TWG CLM, 2007], [182, TWG CLM, 2008].

#### 1.4.5.1.3 Staged combustion

##### Description and achieved environmental benefits

Staged combustion is applied at cement kilns with an especially designed precalciner. The first combustion stage takes place in the rotary kiln under optimum conditions for the clinker burning process. The second combustion stage is a burner at the kiln inlet, which produces a reducing atmosphere that decomposes a portion of the nitrogen oxides generated in the sintering zone. The high temperature in this zone is particularly favourable for the reaction which reconverts the NO<sub>x</sub> to elementary nitrogen. In the third combustion stage, the calcining fuel is fed into the calciner with an amount of tertiary air, producing a reducing atmosphere there, too. This system reduces the generation of NO<sub>x</sub> from the fuel, and also decreases the NO<sub>x</sub> coming out of the kiln. In the fourth and final combustion stage, the remaining tertiary air is fed into the system as 'top air' for residual combustion.

Calciners differ from one another essentially in the location of the fuel input, the way in which the fuel, kiln feed and tertiary air are distributed, and the geometric configuration.

Staged firing technique can, in general, only be used with kilns equipped with a precalciner. Substantial plant modifications are necessary in cyclone preheater systems without a precalciner. If this cannot be combined with an increase in production capacity, the manufacturers offer a solution with so-called 'small' tertiary air ducting and a calciner. In this

case, only a small proportion of about 10 – 25 % of the total heat needed from the kiln is passed through the calciner, but this is sufficient to produce a reducing zone for decomposing nitrogen oxides. On the other hand, experiences from a kiln with 10 % firing in the kiln inlet shows that this is not always sufficient to produce a sufficient reducing zone.

Lump waste fuel (for example tyres) firing is a possible variant of the staged combustion technique as a reducing zone is created when the lump fuel is burned. In preheater/precalciner kilns, the lump fuel can be introduced at the kiln inlet or at the precalciner. Lump fuel firing is reported to have a positive effect on NO<sub>x</sub> reduction (up to 20 – 30 % reduction) [76, Germany, 2006]. However, it is very difficult to produce a controlled reduction atmosphere with lump fuel firing [9, CEMBUREAU, 1997 November].

#### **Cross-media effects**

Emissions of CO and SO<sub>2</sub> can increase if the combustion process is not completed in the precalciner and problems with CO and clogging have been reported when attempting high efficiencies.

#### **Operational data**

Some modern well optimised plants achieve emission levels of below 450 mg NO<sub>x</sub>/Nm<sup>3</sup> (daily average value) with multistage combustion and by using an appropriate fuel mix, such as highly reactive fuels, whereas with low reactive fuels, 800 – 1000 mg/Nm<sup>3</sup> (daily average value) might be achieved, as also shown from experience in Spain. Similar NO<sub>x</sub> reduction has been reported when using secondary fuels.

During tests in France in 2002 (e.g. precalciner operating on staged combustion by using 100 % sulphurated petcoke as fuel), a NO<sub>x</sub> reduction of about 200 mg/Nm<sup>3</sup> was achieved with initial NO<sub>x</sub> levels of 1000 mg/Nm<sup>3</sup>. However, this was only obtained during short periods of the tests and by using an optimal raw meal for burnability. More extreme operating conditions may allow lower NO<sub>x</sub> emission levels to be achieved. However, often these operating conditions lead to operational problems like increasing build-ups in kilns and calciners. An increase of the CO emissions is only observed in very few plants designed with relatively short residence times or where combustion is not properly optimised.

In some cases, possible reductions in NO<sub>x</sub> by up to 50 % were specified by the suppliers of the different staged firing systems. However, it is difficult to maintain the guaranteed values for this level of NO<sub>x</sub> abatement while at the same time limiting the CO emissions.

#### **Applicability**

Staged firing technique can, in general, only be used with kilns equipped with a precalciner. Substantial plant modifications are necessary in cyclone preheater systems without a precalciner.

*Precalciner kilns* allow independent settings of the oxidation/reducing levels in the cement kiln and in the precalciner kiln. Injection of parts of the fuel can lead to decreased NO<sub>x</sub> emissions.

Adding fuel to the grate of the *Lepol kiln* can lead to a significant NO<sub>x</sub> reduction, but may develop/increase other emissions.

*Cyclone preheater kilns without a precalciner* allow a reduction of NO<sub>x</sub> emissions; however, emissions of SO<sub>2</sub> and VOC may increase because of the local reducing zone. These emissions should be continuously monitored.

In the UK, a *long kiln with mid-kiln staged combustion* has been in operation for several years.

#### **Economics**

The investment costs for installing staged combustion at a precalciner kiln are EUR 0.1 million to 2.0 million, depending on the design of the existing calciner. The investment costs for a

precalciner and the tertiary duct for a 3000 tonne/day preheater kiln with a grate cooler into a precalciner kiln are about EUR 1 million to 4 million. The investment costs for the transformation of a 3000 tonne/day preheater kiln with a satellite cooler into a precalciner kiln with a grate cooler are about EUR 15 million to 20 million.

See also Table 1.34 and Table 1.40 (Section 1.4.8.2) where example costs are shown.

### **Driving force for implementation**

Legal requirements.

Local conditions.

### **Example plants and reference literature**

Cement plants in the EU-27.

[9, CEMBUREAU, 1997 November], [12, Netherlands, 1997], [42, Billhardt/Kuhlmann/Ruhland/Schneider/Xeller, 1996 October], [76, Germany, 2006], [85, CEMBUREAU, 2006], [92, Austria, 2006], [101, France/ADEME/MEDD, 2002], [168, TWG CLM, 2007], [182, TWG CLM, 2008], [185, Hackl und Mausnitz, 2003].

#### **1.4.5.1.4 Mid-kiln firing**

##### **Description and achieved environmental benefits**

In long wet and long dry kilns, the creation of a reducing zone by firing lump fuel can reduce NO<sub>x</sub> emissions. As long kilns usually have no access to a temperature zone of about 900 – 1000 °C, mid-kiln firing systems have been installed at some plants in order to be able to use waste fuels that cannot pass the main burner (for example tyres) [9, CEMBUREAU, 1997 November].

##### **Cross-media effects**

The rate of burning waste fuels can result in the chains being burned out or can have an effect on product quality.

##### **Operational data**

A few of these installations exist and NO<sub>x</sub> reductions of 20 – 40 % have been reported in some cases.

##### **Applicability**

Mid-kiln firing can, in principle, be applied to rotary kilns.

The rate of the burning of fuels can be critical. If it is too slow, reducing conditions can occur in the burning zone, which may severely affect product quality. If it is too high, the kiln chain section can be overheated – resulting in the chains being burned out.

Mechanical design considerations mean that the fuel can only be injected intermittently, once per kiln revolution. To maintain continuity of the heat input, solid, slow burning fuels such as tyres or other waste fuels in containers may be used.

A temperature range of less than 1100 °C excludes the use of hazardous waste with a chlorine content of greater than 1 %.

##### **Economics**

Capital costs may be in the region of EUR 0.8 million – 1.7 million for the kiln conversion and fuel handling equipment, and the annual labour and maintenance costs may be of a similar order.

### **Driving force for implementation**

Legal requirements.

Local conditions.

#### **Example plants and reference literature**

Cement plants in the EU-27.

[9, CEMBUREAU, 1997 November], [21, BCA, 1997 October], [168, TWG CLM, 2007], [182, TWG CLM, 2008].

#### **1.4.5.1.5 Mineralised clinker**

##### **Description and achieved environmental benefits**

The addition of mineralisers, such as fluorine, to the raw material is a technique to adjust the clinker quality and allow the sintering zone temperature to be reduced. By reducing/lowering the burning temperature, NO<sub>x</sub> formation is also reduced.

##### **Cross-media effects**

Excessive additions of calcium fluoride could lead to an increase in HF emissions.

Reduced energy demand.

Additions could affect the final product quality.

##### **Operational data**

The NO<sub>x</sub> reduction might be between 10 and 15 %, but reductions of up to 50 % have been reported.

##### **Applicability**

This measure/technique can, in principle, be applied to rotary kilns.

##### **Economics**

Depending on the price of the mineralisers.

##### **Driving force for implementation**

Legal requirements.

Local conditions.

#### **Example plants and reference literature**

Cement plants in the EU-27.

[10, Cementa AB/Hagström, 1994], [103, CEMBUREAU, 2006], [168, TWG CLM, 2007].

#### **1.4.5.1.6 Process optimisation (NO<sub>x</sub>)**

##### **Description and achieved environmental benefits**

Optimisation of the process, such as smoothing and optimising the kiln operation and firing conditions, optimising the kiln operation control and/or homogenisation of the fuel feedings, can be applied for reducing NO<sub>x</sub> emissions. General primary optimisation techniques, such as process control techniques, an improved indirect firing technique, optimised cooler connections and fuel selection, and optimised oxygen levels have been applied. Until 2007, progress was observed in the reduction of NO<sub>x</sub> emissions by using process-integrated techniques.

##### **Cross-media effects**

Reduced energy demand.

##### **Operational data**

NO<sub>x</sub> emissions, by applying process control optimisation techniques, range between 500 and 1000 mg/Nm<sup>3</sup>. Some modern well optimised preheater kiln systems and preheater/precalciner kiln systems may achieve NO<sub>x</sub> emission levels of less than 500 mg/Nm<sup>3</sup> by applying all process-integrated techniques.

### **Applicability**

The quality of the raw materials (the firing properties of the raw mix), the availability of high volatile fuels and the design of the kiln system are among the reasons for not being able to achieve the level quoted above.

### **Economics**

The aim of process optimisation is to improve costs.

### **Driving force for implementation**

Legal requirements.

Local conditions.

### **Example plants and reference literature**

Cement plants in the EU-27.

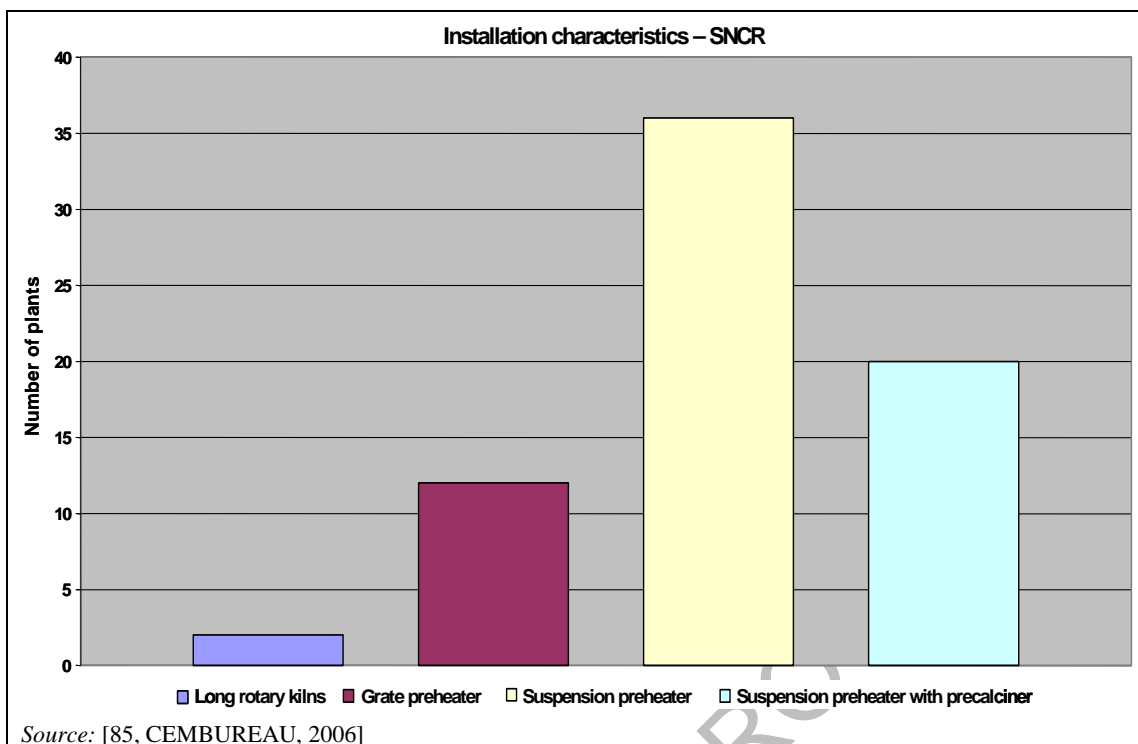
[76, Germany, 2006], [101, France/ADEME/MEDD, 2002], [103, CEMBUREAU, 2006], [168, TWG CLM, 2007], [182, TWG CLM, 2008].

#### **1.4.5.1.7 Selective non-catalytic reduction (SNCR)**

##### **Description and achieved environmental benefits**

In 2008, there were about 100 full scale SNCR installations in operation in the EU-27 and EU-23+ countries (see Glossary). Selective non-catalytic reduction (SNCR) involves injecting ammonia water (up to 25 %  $\text{NH}_3$ ), ammonia precursor compounds or urea solution into the combustion gas to reduce  $\text{NO}$  to  $\text{N}_2$ . The reaction has an optimum effect in a temperature window of about 830 to 1050 °C, and sufficient retention time must be provided for the injected agents to react with  $\text{NO}$ .

Laboratory experiments as well as full scale trials have to be performed to identify the optimised temperature window for urea or ammonia water. The right temperature window can usually be obtained in suspension preheater kilns, precalciner kilns and in Lepol kilns. However, also plants using long rotary kilns have been equipped with SNCR in order to reduce the  $\text{NO}_x$  emissions. Figure 1.64 gives an overview of the characteristics of the cement plants where SNCR has been applied.



**Figure 1.64: Cement plant characteristics with SNCR application in EU-23+ countries**

The most common  $\text{NH}_2\text{-X}$  agent is urea up to 32 % followed by ammonia water up to 27 %, as shown in Figure 1.65 [85, CEMBUREAU, 2006]. Waste solutions from other production processes can be utilised as ammonia carriers as well [76, Germany, 2006]. Other possible reduction agents which can be employed on an industrial scale are ammonia gas, ammonium salt solutions, dried urea (urea pills), urea solutions, nitrolime or cyanamide and similar other substances [20, Rother, 1996 January,]. Storage and transport facilities have to be designed according to the physico-chemical properties of the respective agent and can require additional safety techniques. Experience shows that for most applications ammonia water is the best agent for SNCR at preheater and precalciner kiln systems [9, CEMBUREAU, 1997 November]. A favourable good ammonia stoichiometric distribution is important in order to achieve the highest efficiency of  $\text{NO}_x$  reduction and to reduce the ammonia slip. In order to achieve an optimal utilisation of the injected reduction reagent – ammonia water or urea solution – and to cater for high  $\text{NO}_x$  reduction efficiency, the following points are to be considered for the SNCR design and operation. These considerations will allow an optimal technical and economic operation of an SNCR system:

- inject the agent in the appropriate temperature window of 830 to 1050 °C; aim to avoid ammonia slip or combustion of ammonia – the latter being a potential source of secondary  $\text{NO}_x$
- if the temperature window changes – adjust the location of injection nozzles; probably multiple layers of nozzles are appropriate to cover this issue; possibly manufacture a temperature profile of the injection and monitor continuously to cater for such a demand
- adjust the spray angle and penetration depth of the injected aqueous solution by varying:
  - the water content of the solution
  - the pressure level of the atomising air
  - the location of the nozzle and
  - the direction of the injected ammonia
- nozzles in levels temporarily not used – cool ideally with air to avoid heat related wear; nozzles which are only occasionally used, extract to avoid undue air consumption

- make sure that the area of injection is covered properly with the correct amount of ammonia solution to avoid over- and under stoichiometric injection. By doing this, undue ammonia slip or untreated NO by bypassing the SNCR can be avoided
- if needed, measure the NO<sub>x</sub> level in each cyclone string where applicable (i.e. double riser ducts) and trim injection accordingly
- check stoichiometry via mass balance of abated NO<sub>x</sub> to injected ammonia, that no excess ammonia is injected. By doing so, the ammonia slip can be minimised. Furthermore, the nearer the stoichiometry is to one – the better the economics will be.

Figure 1.65 shows the different nitrogen carriers/NH<sub>2</sub>-X agents used for NO<sub>x</sub> reduction by SNCR in several cement plants in EU-23+ countries.

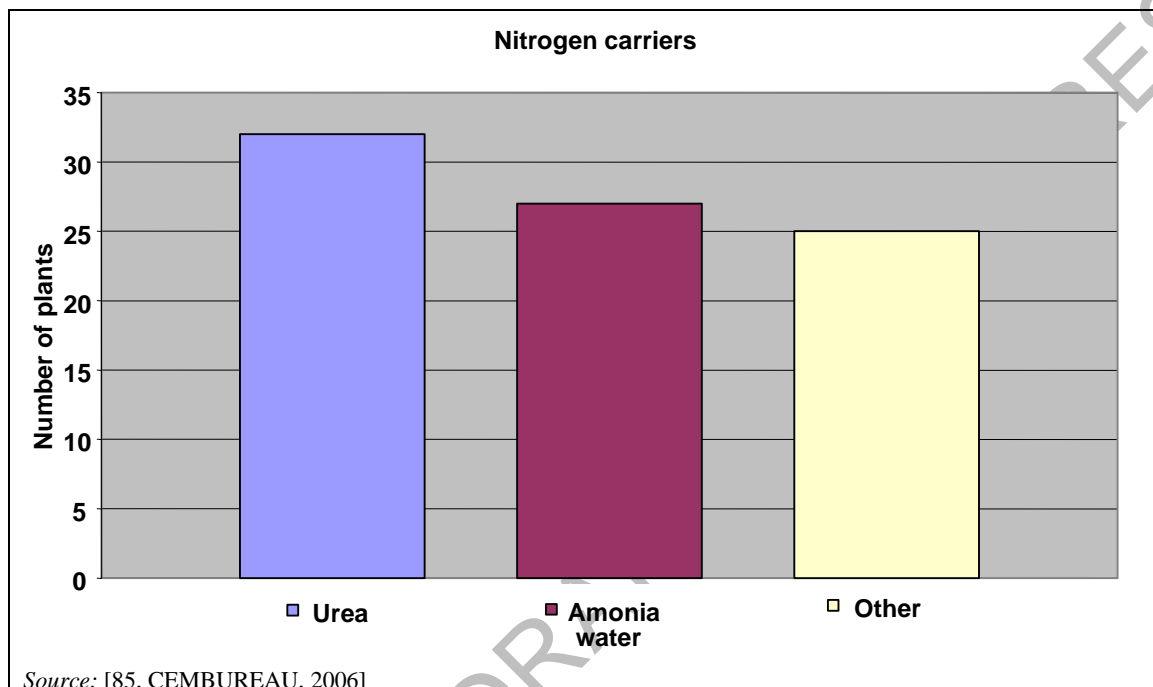


Figure 1.65: Nitrogen carriers/NH<sub>2</sub>-X agents used by SNCR in EU-23+ countries

Further development in the use of SNCR technique is necessary if the plant is already equipped with a staged combustion system. Simultaneous use of these techniques requires the temperatures, residence times and gas atmosphere in the reaction section to be adjusted to suit one another. In order to gather experience with simultaneous application of these two abatement techniques, operational trials were carried out at several kiln plants equipped with precalciners. Trials have shown that it is possible, in principle, to combine the two techniques. NO<sub>x</sub> emissions reduction can be achieved by injecting the reducing agent into the oxidising zone as well as into the reducing zone of a staged calciner. The injection into the oxidising zone is favourable as the probability of increased CO emissions is lower as if the injection occurs in the reducing zone. Due to the different calciner techniques, design and control of the SNCR installation has to be adapted and optimised to the respective technique. If the reducing agent is added just before the bottom cyclone stage, the retention time of the reacting agents in the right temperature window is no longer sufficient to achieve a significant NO<sub>x</sub> abatement. Consequently, an increased ammonia slip is likely. On the other hand, several trials showed that when injecting the reducing agent before the mixing chamber of the calciner in an area where the combustion of the calciner fuel is still taking place, an increase in CO emissions can occur.

#### High efficiency SNCR

The high efficiency SNCR technique is a further development of the SNCR technique which is used in cement plants. Under controlled conditions over layers of nozzles (lances), ammonia



water (25 % ammonia solution) is injected into the preheater. The arrangement of the lances is determined by the temperature profile in the riser duct. The injection of ammonia water is process controlled by the measured temperature profile in the preheater near the lances. Because of a favourable good ammonia distribution, the  $\text{NH}_3$  slip and the consumption of ammonia water can be reduced. This SNCR technique was installed in 1996/97 at two Swedish plants and at at least one German plant.

#### *Ammonia slip*

It is important that ammonia is injected into the kiln system where a temperature range of 830 - 1050 °C exists. If the temperature falls below this level, unconverted ammonia is emitted (so-called  $\text{NH}_3$  slip) and at significantly higher temperatures the ammonia is oxidised to  $\text{NO}_x$ .  $\text{NH}_3$  slip may also occur at elevated  $\text{NH}_3:\text{NO}_2$  molar ratios, i.e. from a molar ratio of about 1.0 - 1.2. In other sectors of industry,  $\text{NH}_3$  slippage has sometimes resulted in the formation of aerosols of ammonia salts which has passed through the filter and become visible as a white plume above the exhaust gas stack. Investigations have shown that considerably lower aerosol levels are produced by cement plants. Unused ammonia may be oxidised and transformed into  $\text{NO}_x$  and water in the atmosphere and  $\text{NH}_3$  slippage may also result in ammonia enriched dust which may not be recycled to the cement mill. The possible  $\text{NH}_3$  slip should be taken into account in the design of SNCR installations. The  $\text{NO}_x$  reduction rate cannot simply be increased at will, as a higher dosage might cause  $\text{NH}_3$  slippage (see also Figure 2.50 in the lime chapter). Correct operation (appropriate control system, optimised injection of  $\text{NH}_3$  water) of the SNCR system does not entail any higher ammonia emissions than normal.

#### **Cross-media effects**

By using ammonia water solution as the reducing agent, ammonia slip may occur as described above and unconverted ammonia is emitted. Emissions of nitrous oxide ( $\text{N}_2\text{O}$ ) may also occur; however, they only play a minor role, as spot tests revealed concentrations of between 1 and 5  $\text{mg}/\text{Nm}^3$  which is approximately equal to the detection limit. Furthermore, an increase of carbon monoxide (CO) emissions may occur when injecting the reducing agent before the mixing chamber of the calciner in an area where the combustion of the calciner fuel is still taking place.

Additional heat for the evaporation of water is balanced with heat released in the exothermic  $\text{DeNO}_x$  reaction which causes a small increase in  $\text{CO}_2$  emissions. The transport and storage of aqueous ammonia is a potential danger for the environment and requires some additional safety techniques. Consideration is also required as to the impacts associated with the production of ammonia and the transportation of water associated with the dilution of the solution.

By using urea as the reducing agent, the main end-products are ammonia and carbon dioxide. Emissions of nitrous oxide ( $\text{N}_2\text{O}$ ) and various concentrations of isocyanic acid (HNCO) and nitric oxide (NO) are reported from urea decomposition. The  $\text{N}_2\text{O}$  level from urea is always significantly higher than from aqueous ammonia. The generation of nitrous oxide from urea varies with the temperature. Studies show that high  $\text{NO}_x$  reduction and maximum  $\text{N}_2\text{O}$  generation have the same temperature window. Most of the isocyanic acid will be hydrolysed to ammonia and carbon dioxide; however, isocyanic acid slip from SNCR installations is reported. Furthermore, one study shows that in addition to nitrous oxide ( $\text{N}_2\text{O}$ ) and isocyanic acid (HNCO), injected urea will also generate cyanic ions (NCO). This product is not formed when ammonia is used under SNCR conditions. It also has to be noted that the use of urea will generate higher emissions of carbon monoxide (CO) than the use of ammonia.

#### **Operational data**

Most SNCR installations operating in 2006 were designed and/or operated for  $\text{NO}_x$  reduction rates of 30 – >50 % (with  $\text{NH}_3:\text{NO}_2$  molar ratios of 0.5 – 0.9) and  $\text{NO}_x$  emission levels of between <350 – 800  $\text{mg}/\text{Nm}^3$  (daily average values), depending on the initial  $\text{NO}_x$  level.

Installations designed and/or operated for higher reduction rates will do better as described below (high efficiency SNCR). Two plants with SNCR installations delivered by two different suppliers, which both guaranteed 80 % reduction, are achieving reduction rates of 80 – 90 %

(with an initial NO<sub>x</sub> level of between 800 – 1100 mg/Nm<sup>3</sup>) which corresponds to NO<sub>x</sub> emissions of less than 200 mg/Nm<sup>3</sup>, measured as the yearly average value (see Section 6.2.4). Furthermore, NO<sub>x</sub> emissions of 190 mg/Nm<sup>3</sup> (yearly average value) were reported from a Swedish plant in 2006.

In combination with process-integrated techniques and with highly efficient SNCR installations operating at reduction rates of 80 – 90 %, daily average concentrations of less than 500 mg/Nm<sup>3</sup> are achievable, also when initial levels are above 2000 mg/Nm<sup>3</sup> [43, Wulf-Schnabel/Lohse, 1998].

### *High efficiency SNCR and ammonia slip*

High efficiency SNCR was installed in 1996/97 at two Swedish plants and at at least one German plant. These Swedish plants (altogether with three kilns) use dry process cyclone preheater/precalciner kilns. A reduction of >80 % has been achieved when applying a NH<sub>3</sub>:NO molar ratio of 1.0 – 1.2 and so far an increase of up to 20 mg/Nm<sup>3</sup> as the daily average of NH<sub>3</sub> has been measured. No significant increases in N<sub>2</sub>O and CO emissions have been measured and no traces of any NH<sub>3</sub> have been found in the cement. In 2001 at one plant, the initial molar ratio was found to be 1.0 – 1.2 (mol NH<sub>3</sub> to present mol of NO<sub>x</sub>) which was computed to 1.2 to 1.4 for removed NO<sub>x</sub> with an average removal efficiency of 80 % while at the second plant the ammonia ratio was in the range of 1.2 – 1.4 mol/mol (present NO<sub>x</sub> to injected NH<sub>3</sub>) or 1.5 – 1.8 (reduced NO<sub>x</sub> to injected NH<sub>3</sub>). A NO<sub>x</sub> emission level of 200 mg/Nm<sup>3</sup> was reported (yearly average value). It has to be noted that this NO<sub>x</sub> emission level of 200 mg/Nm<sup>3</sup> has been achieved since 1998 from both Swedish plants with the presence of an initial NO<sub>x</sub> level of 800 – 1000 mg/Nm<sup>3</sup>, a reduction rate of 80 % and a stable operating process.

In Germany, SNCR (reducing agent ammonia water by 25 %) was installed at a four stage cyclone preheater kiln with a production capacity of about 3000 t clinker/day. Initial NO<sub>x</sub> levels of between 500 – 1200 mg/Nm<sup>3</sup> (on a daily basis) were reported. Over a period of several years, long term experience showed that an emission levels of 500 mg NO<sub>2</sub>/Nm<sup>3</sup> and less (daily average value) could constantly be achieved without any significant ammonia slip.

In 2007, the latest results from a long term test (six months performance test) showed that NO<sub>x</sub> emission values of 350 mg/Nm<sup>3</sup> and 200 mg/Nm<sup>3</sup> (daily average values) were achieved by applying corresponding NH<sub>3</sub>:NO molar ratios of 0.7 – 0.8 and 1.4 – 1.5. During these performance tests, NH<sub>3</sub> emissions were measured continuously. The NH<sub>3</sub> measurements however resulted in significant ammonia slip by keeping 200 mg/Nm<sup>3</sup> NO<sub>x</sub> particularly during mill-off operation (max. 50 – 200 mg/Nm<sup>3</sup>). Altogether, the ammonia slip was twice as high in order to achieve the emission level of 200 mg/Nm<sup>3</sup> (NH<sub>3</sub>: three months average value of 11 mg/Nm<sup>3</sup>) compared to a level of 350 mg/Nm<sup>3</sup> (NH<sub>3</sub>: three months average value of 21 mg/Nm<sup>3</sup>). The mill-off operation ratio in this case was about 10 – 20 %. A relevant enrichment of ammonia in the raw meal and the ESP dust could not be observed during the performance test. The tests showed that ammonia emissions should carefully be considered (see also Section 6.2.4.2). The ammonia slip, which occurs because of the above process, sets the limits to the overstoichiometric addition of reducing agents [160, Germany, 2007], [173, Germany, 2007].

In 2004 in Ireland, investigations carrying out short term SNCR trials showed low NH<sub>3</sub> concentrations of between 4 and 26 mg/Nm<sup>3</sup> (10 % O<sub>2</sub>) in the raw gas after the preheater of the kiln. This was because of an optimised injection configuration resulting in a highly efficient reduction reaction and only in minor amounts of unreacted ammonia. These concentrations were measured by testing two injection configurations (standard conditions; NH<sub>3</sub>:NO molar ratio of one (1) with a NO<sub>x</sub> reduction rate of 50 %). The NH<sub>3</sub> slip sets limits to the overstoichiometric addition of reducing agent [123, Ireland, 2005].

Detailed descriptions of a high efficiency SNCR technique used in the EU can be found in Section 6.2.4. Ammonia emissions from cement manufacturing are described in Section 1.3.4.9.

**Applicability**

SNCR and high efficiency SNCR are, in principle, applicable at rotary cement kilns. The injection zones vary with the type of kiln process.

In long wet and dry process kilns it is very difficult to obtain the right temperature and retention time needed. Only one plant with a long dry kiln and one plant (Denmark) with a long wet kiln have successfully applied SNCR reduction and reach efficiencies of between 40 and 50 %.

Ammonia related storage risks are reduced by storing ammonia water solution by 25 % concentration.

**Economics**

For a 3000 tonnes/day preheater kiln with initial NO<sub>x</sub> emissions of up to 2000 mg/Nm<sup>3</sup> and with a NO<sub>x</sub> reduction of up to 85 % (i.e. up to 300 mg NO<sub>x</sub>/Nm<sup>3</sup>) the investment cost for an SNCR using ammonia water as the reducing agent is EUR 0.5 – 1.2 million, with the cost being very influenced by local regulations on the storage of ammonia water. The operating cost for the same kiln is EUR 0.3 – 0.5 per tonne clinker, the cost mainly determined by the cost of the injected ammonia [9, CEMBUREAU, 1997 November], [85, CEMBUREAU, 2006].

SNCR was installed in 1996/97 at two Swedish plants. For one kiln, the investment costs were about EUR 1.2 million (EUR 0.65 million for the SNCR installation and another EUR 0.55 million for the ammonia water storage) and the operating cost was about EUR 0.55 per tonne clinker. The total cost (investment + operating costs) was less than EUR 0.6 per tonne clinker. The investment costs for the other kiln were about EUR 0.55 million and the operating cost was about EUR 0.3 per tonne clinker. The driving force for these plants to invest in high-performing SNCR installations was the Swedish policy regarding NO<sub>x</sub> emissions. According to this policy any investment in abatement that has a total cost (investment + operating) of less than EUR 4.5 (SEK 40) per kilo of abated NO<sub>x</sub> (as NO<sub>2</sub>) may be acceptable.

A survey covering 26 cement plants using the SNCR technique, which was carried out in 2004 by the German cement industry, revealed average investment costs of between EUR 0.5 and 0.75 million. However, France reported costs of up to EUR 1 million. The construction of the storage for the reducing agent amounted to about 50 % of the investment costs. Total costs of between EUR 0.5 and 0.7 per tonne clinker were given for the use of ammonia solution and medium to high NO<sub>x</sub> abatement rates. Detailed cost calculations for a rotary kiln with a clinker capacity of 1500 t/d resulted in specific costs of between EUR 0.4 and 1.2 per tonne clinker, dependent on the NO<sub>x</sub> reduction rate. Additional calculations for a 3500 t/d kiln and a NO<sub>x</sub> reduction from 850 to 250 mg/Nm<sup>3</sup> resulted in investment costs of EUR 0.88 million and operating costs of EUR 0.40 per tonne clinker.

See also Table 1.34 and Table 1.40 (Section 1.4.8.2) where example cost data for the SNCR technique are shown.

**Driving force for implementation**

Legal requirements.  
Local conditions.

**Example plants and reference literature**

Plants in the EU-27, high efficiency SNCR plants in Sweden and Germany (Maerker). Descriptions of example plants from Sweden and Germany are given in Sections 6.2.4.1 and 6.2.4.2 respectively.  
[8, CEMBUREAU, 2001], [9, CEMBUREAU, 1997 November], [10, Cementa AB/Hagström, 1994], [20, Rother, 1996 January,], [24, Junker, 2001], [41, Kupper/Brentrup, 1992], [42, Billhardt/Kuhlmann/Ruhland/Schneider/Xeller, 1996 October], [43, Wulf-Schnabel/Lohse, 1998], [76, Germany, 2006], [85, CEMBUREAU, 2006], [101, France/ADEME/MEDD, 2002], [105, YARA, 2006], [114, Sweden, 2006], [123, Ireland, 2005], [131, YARA, 2007],

[160, Germany, 2007], [168, TWG CLM, 2007], [173, Germany, 2007], [182, TWG CLM, 2008].

#### **1.4.5.1.8 Selective catalytic reduction (SCR)**

##### **Description**

SCR reduces NO and NO<sub>2</sub> to N<sub>2</sub> with the help of NH<sub>3</sub> and a catalyst at a temperature range of about 300 – 400 °C. This technique is widely used for NO<sub>x</sub> abatement in other industries (coal fired power stations, waste incinerators). In the cement industry, basically two systems are considered: low dust configuration between a dedusting unit and stack, and a high dust configuration between a preheater and a dedusting unit. Low dust exhaust gas systems require the reheating of the exhaust gases after dedusting, which may cause additional energy costs and pressure losses. High dust systems are considered preferable for technical and economical reasons. These systems do not require reheating, because the waste gas temperature at the outlet of the preheater system is usually in the right temperature range for SCR operation.

Large NO<sub>x</sub> emissions reductions of 85 – 95 % are potentially achievable by SCR high dust systems and until 2008, only high dust systems have been tested in the cement industry.

In 2008 in the EU-27, in total two full scale production runs have been carried out and experience has been collected in order to remove the technical and economic uncertainties related to upscaling of the SCR technique. The main uncertainties are related to the high dust concentration of up to 100 g/Nm<sup>3</sup> in the gases, dust removal techniques, type and lifetime of the catalysts, total investment and operating costs. Experience also shows that appropriate design and chemical composition of the catalysts are very important.

Considering the high reduction potential, the successful pilot tests, the two full scale SCR installations and the fact that SCR is state-of-the-art technique for comparable installations in other sectors, SCR is an interesting technique for the cement industry. There are at least two suppliers in Europe that offer full scale SCR to the cement industry with guaranteed performance levels of 100 – 200 mg/Nm<sup>3</sup>. However, SCR capital expenditure is still higher than for SNCR [12, Netherlands, 1997].

##### **Achieved environmental benefits**

Reduction of NO<sub>x</sub> emissions.

As the catalysts remove hydrocarbons as well and if this technique is designed for, SCR will, in general, also reduce emissions of VOC and PCDD/F.

##### **Cross-media effects**

Electrical energy demand may increase due to the internal dedusting system of the SCR reactor and additional pressure losses.

Low dust exhaust gas systems require reheating the exhaust gases after dedusting, which may cause additional energy costs and pressure losses.

Catalysts have to be recycled or disposed of.

##### **Operational data**

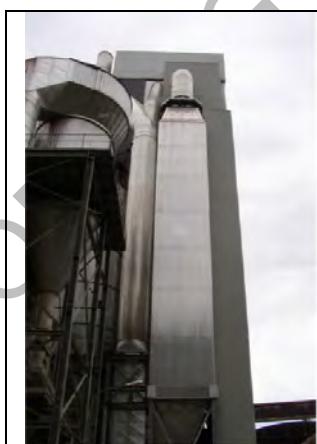
In the 1990s, early pilot plant trials in Germany, Italy and Sweden showed promising results. The NO<sub>x</sub> emission levels were approximately 100 – 200 mg/Nm<sup>3</sup> with no loss of catalyst activity. In Austrian cement plants between 1996 and 2000, three pilot tests on small portions (3 % of the exhaust gas) and with a high dust configuration took place. One of these was successful in NO<sub>x</sub> reduction efficiency which, however, was not continued. One concern raised was the operational availability of the catalysts. Two pilot trials were not successful because of the deactivation of the catalysts after a few weeks due to heavy metals and alkali metal

compounds. In one plant, considerable abrasion of the catalysts occurred after a working period of about 5000 hours [18, Göller, 2001], [92, Austria, 2006].

In 2000, the first full scale SCR demonstration plant by using a high dust SCR system was built in Germany with government funding and was in operation from 2001 until 2006. However in 2008, the plant is waiting for improved catalyst types. In comparison with SNCR, this system has a lower consumption of  $\text{NH}_3$  resulting in lower ammonia operational costs. At the top of the four stage preheater, the waste gas has a temperature of 320 – 350 °C that is suitable for SCR and does not require reheating, as is necessary in the case of configuration between the fabric filter and stack, thus reducing energy costs. The  $\text{NO}_x$  abatement efficiency is usually in the range of 59 to 67 %. However, if the operating conditions were not usual with raw gas concentrations of 3000  $\text{mg}/\text{Nm}^3$  and higher,  $\text{NO}_x$  abatement efficiencies of more than 80 % were observed. In regular operation, the SCR reduces  $\text{NO}_x$  emissions from initial raw gas concentrations of 1000 to 1600  $\text{mg}/\text{Nm}^3$  to about 400 to 550  $\text{mg}/\text{Nm}^3$ . With a molar ratio of 0.8 to 0.9, the consumption of  $\text{NH}_3$  is significantly lower than by the application of SNCR. It has to be noted that  $\text{NH}_3$  from the raw material also serves as the reduction agent in the reactor, thus the emission level of residual  $\text{NH}_3$  is very low. At this German plant, the SCR usually led to  $\text{NH}_3$  emissions of below 1  $\text{mg}/\text{Nm}^3$  by achieving a  $\text{NO}_x$  emission level of 300  $\text{mg}/\text{Nm}^3$ . These results may indicate the potential of the technique, especially as they were also achieved with three catalytic layers only, and the emission level of residual  $\text{NH}_3$  was still around 1  $\text{mg}/\text{Nm}^3$ . A more detailed description of this plant, achieved emissions ranges and costs are shown in Section 6.2.5.

In Italy, one SCR plant is in operation for  $\text{NO}_x$  reduction. Since 2006, a full scale high dust SCR system for  $\text{NO}_x$  abatement has been in operation on a kiln line having a kiln capacity of 1720 t/d (permitted capacity of 2400 t/d). The dimensions of the chamber holding the modules which are envisaged for seven layers (levels) of catalysts are 4 m in width, 6 m in length and 27 m in height, as shown in Figure 1.66.

The volume of catalysts installed is 21  $\text{m}^3$  for each level, in total 63  $\text{m}^3$  for three levels with an uninstalled backup capacity of 42  $\text{m}^3$  for an additional two levels to meet the permitted capacity of 2400 t/d. The catalysts are automatically cleaned by compressed air at 5 or 6 bar with a consumption of 2.5 kWh/t of clinker for the compressor line. After 7000 hours of operation, no reduction inactivity of the catalysts was found.



**Figure 1.66: Example of an SCR installation**

Source: [140, Italy, 2007]



**Figure 1.67: Example of an individual catalyst used for the SCR technique**

Source: [140, Italy, 2007]



**Figure 1.68: Example of a module position used for the SCR technique**

Source: [140, Italy, 2007]

An ammonia solution of 25 % concentration is used as the reducing agent. The flow varies from 30 to 300 litres per hour depending on kiln conditions and the type of fuels used, while the gas

flowrate is 110 000 m<sup>3</sup>/h. The ammonia solution is injected into the gas stream below the uppermost cyclone where the appropriate temperature regime of 320 – 350 °C exists. During the first 10 months of operation, the mean consumption of ammonia solution was 0.7 – 1 kg/t clinker with a reduction of NO<sub>x</sub> emissions to less than 450 mg/Nm<sup>3</sup> (10 % O<sub>2</sub>). However, from this Italian plant, reports and test results show that the design of this SCR technique can reduce the NO<sub>x</sub> emissions at the stack to <200 mg/Nm<sup>3</sup> (at actual % O<sub>2</sub>). Depending on the inlet NO<sub>x</sub> level and the NH<sub>3</sub> injection rate, the NO<sub>x</sub> reduction efficiency ranges from 43 – 95 %. Corrections to 10 % O<sub>2</sub> would yield even lower NO<sub>x</sub> concentrations. Before the installation of the SCR technique, ammonia in the flue-gas was measured at 50 – 150 mg/Nm<sup>3</sup> which originated from raw materials. This amount of ammonia has since been used by the SCR process resulting in NH<sub>3</sub> emissions of less than 1 mg/Nm<sup>3</sup> and a molar ratio (injected NH<sub>3</sub>:NO<sub>x</sub>) of less than unity. Parameters, emissions and costs of the SCR technique, reported from the German cement plant and the Italian cement plant using this NO<sub>x</sub> reduction technique, are shown in Table 1.35.

Technique	Kiln system applicability	Reduction efficiency (%)	Reported emissions		Reported costs	
			mg/Nm <sup>3</sup> (daily average value)	kg NO <sub>x</sub> /t clinker	Investment (EUR/tonne clinker)	Operating (EUR/tonne clinker)
SCR	Possibly all	43 – 97	300 – 500 <sup>(1)</sup>	0.15 – 1.0	2.5 <sup>(2)</sup> 3.2 – 4.5 <sup>(3)</sup> ( <sup>4</sup> )	1.75 – 2 <sup>(3)</sup>

(<sup>1</sup>) Results from pilot tests and long term operation of the demonstration plant  
 (<sup>2</sup>) Costs estimated by UBA Germany for a full scale installation (kiln capacity 1500 t clinker/d, initial emissions of 1200 mg/Nm<sup>3</sup> and final levels of 200, 500 and 800 mg/Nm<sup>3</sup> (daily average value)  
 (<sup>3</sup>) Costs calculated by the Association of the German Cement Industry (VDZ) covering operating costs, plus depreciation on the investment of a full scale installation (kiln capacity 1500 t clinker/d, initial emissions of 1200 mg/Nm<sup>3</sup> and a final level of 200, 500 and 800 mg/Nm<sup>3</sup>)  
 (<sup>4</sup>) Highest value belongs to the SCR system from the Italian cement plant, where EUR 0.9 million for catalysts elements are included (three layers of modules in place plus two in store)

Source: [85, CEMBUREAU, 2006]

**Table 1.35: SCR parameters, emissions and costs reported**

### Applicability

SCR has only been tested on preheaters and pilot tested on semi-dry (Lepol) kiln systems, but it is, in principle, applicable to other kiln systems as well depending on the temperature window.

The high dust levels impose high demands on the durability and the operation of the catalysts and the design and chemical composition of the catalysts are very important. Catalysts designed for low dust operation in other industries might not be suitable for high dust operation in a cement plant. High dust operation of an SCR reactor requires a high mechanical durability of the catalyst, a wider pitch than usual for low dust operation and an integrated dedusting system, in order to avoid plugging and activity losses. The appropriate chemical composition of the catalyst has to be evaluated by trials with high dust off-gases of cement kilns. Furthermore, because of the dimensions of the chamber holding the modules and the amount of layers which are used, sufficient space has to be available in order to install the SCR technique.

There are not yet standard catalysts available that are adequate for the cement industry. The various types of catalysts being used are still undergoing trials.

### Economics

The results from the use of the SCR technique have shown a cost level of EUR 1.25 to 2.00 per tonne, depending on the plant size and the NO<sub>x</sub> removal efficiency required. The SCR technique, in contrast to the SNCR technique, is dominated by the investment costs, which are 4 to 9 times higher than for a SNCR system. The use of catalysts increases the operational costs.

Furthermore, the energy consumption is essentially due to pressure drop and cleaning air for the catalyst. Specific costs of SCR have declined to around EUR 1.75 per tonne.

Cementa AB in Slite, Sweden, has a 5800 tonne clinker/day dry process suspension preheater/precalciner kiln. In 1993, they operated a pilot high dust SCR, downstream of an SNCR, for about a year and have investigated how much a full scale SCR installed downstream of the SNCR would cost. This means initial NO<sub>x</sub> levels into the SCR of less than 200 mg/Nm<sup>3</sup>. The estimated investment cost was about EUR 11.2 million and the operating cost was about EUR 1.3 per tonne clinker, giving total costs of EUR 3.2 per tonne clinker. The costs per additional kilo of abated NO<sub>x</sub> were EUR 5.5 – 7.3 for the SCR. These costs were too high and not reasonable according to the company.

Investment costs for a 3000 tonne clinker/day preheater kiln were estimated to be EUR 3.5 million – 4.5 million, remarking that investment cost indications are only known from the supplier but did not including the plant modifications.

Feasibility studies have been carried out in Austria, Germany, the Netherlands and Sweden. The estimated costs for the SCR technique in the cement industry varies greatly, with the production costs and lifetime of the catalysts being major variables.

See also Table 1.34 and Table 1.35 in Section 1.4.5.1 as well as Table 1.40 in Section 1.4.8.2 where example costs data are shown.

#### **Driving force for implementation**

Legal requirements. The implementation of SCR may be suitable to achieve a higher NO<sub>x</sub> abatement efficiency or to achieve a simultaneous reduction of NO<sub>x</sub> and other pollutants, e.g. ammonia from raw materials.

#### **Example plants**

Solnhofer Portland-Zementwerke (Germany), Monselice cement plant (Italy).

#### **Reference literature**

[4, Austria, 1998] [8, CEMBUREAU, 2001], [9, CEMBUREAU, 1997 November], [12, Netherlands, 1997], [18, Göller, 2001], [23, de Jonge, 2001] [24, Junker, 2001], [43, Wulf-Schnabel/Lohse, 1998], [57, European Commission, 2005], [76, Germany, 2006], [80, Alvaro A. Linero, 2006], [85, CEMBUREAU, 2006], [92, Austria, 2006], [140, Italy, 2007],[141, Leibacher/Bellin/Linero, 2007],[168, TWG CLM, 2007], [182, TWG CLM, 2008].

#### **1.4.5.2 Reduction of SO<sub>2</sub> emissions**

The first step with respect to SO<sub>2</sub> control is to consider primary process optimisation techniques, such as optimising the clinker burning process including the smoothing of kiln operation, uniform distribution of the hot meal in the kiln riser and prevention of reducing conditions in the burning process as well as the choice of raw materials and fuels. Moreover, the oxygen concentration in the kiln inlet area is crucial to SO<sub>2</sub> capture in the kiln charge. Increasing the oxygen content in long kilns decreases the SO<sub>2</sub> level and increases the NO<sub>x</sub> level. However, to achieve the specified product quality, the clinker burning process requires an excess of oxygen. Accordingly, there is always a sufficient supply of oxygen to ensure the formation of sulphates in the bottom section of the cyclone preheater or the hot gas chamber of the grate preheater, which are discharged from the kiln system via the clinker. A balance for protecting the environment should be sought by optimising NO<sub>x</sub>/SO<sub>2</sub>/CO by adjusting the back-end oxygen content. In those cases where these techniques are not enough, additional end-of-pipe techniques can be taken. Table 1.36 and Table 1.37 give an overview of techniques that have a positive effect on, that is reduce, the emissions of SO<sub>2</sub> arising from the manufacture of cement, mainly from the preheater and the bypass process. Table 1.36 is a summary of operational data which are available within the text of this section and should be read in conjunction with the

corresponding paragraphs in following sections (see Sections 1.4.5.2.1 – 1.4.5.2.3). In this context, it has to be noted that, when co-incinerating waste, the requirements of **Chapter IV of and Annex VI to the Directive 2010/75/EU** have to be met.

Measures/ techniques	Kiln systems applicability	Reduction efficiency	Emissions data		Cost	
			mg/Nm <sup>3</sup> (1)	kg/tonne (2)	Investment (million EUR)	Operating (EUR/t)
Absorbent addition	All	60 – 80 %	<200 – 400 <sup>(5)</sup>	0.23 – 0.92	0.2 – 0.3	0.1 – 0.4
Wet scrubber	All	>90 %	<10 – 300 <sup>(4)</sup>	0.02 – 0.69	5.8 – 23 <sup>(6)</sup>	0.5 – 2 <sup>(6)</sup>
Activated carbon	Dry	Up to 95 %	<50	<0.11	15 <sup>(3)</sup>	No info.

(1) Normally refers to daily averages, dry gas, 273 K, 101.3 kPa and 10 % O<sub>2</sub>  
(2) kg/tonne clinker: based on 2300 m<sup>3</sup>/tonne clinker  
(3) This cost also includes an SNCR process, referring to a kiln capacity of 2000 tonne clinker/day and initial emissions of 50 – 600 mg SO<sub>2</sub>/Nm<sup>3</sup>, cost data from 1997  
(4) The final achievable emission level is dependent on the initial SO<sub>2</sub> value prior to the installation of the wet scrubber and could be higher  
(5) For an initial SO<sub>x</sub> level of 1200 mg/Nm<sup>3</sup> (see Section 1.4.5.2.1)  
(6) 2008

**Table 1.36: Overview of techniques for controlling and reducing SO<sub>2</sub>**

Table 1.37 presents the number of full scale installations known in the EU-27 and EU-23+ countries to be using abatement techniques to reduce SO<sub>2</sub> emissions in 2008.

Techniques for reducing/controlling SO <sub>2</sub> emissions				
Country		Absorbent addition	Wet scrubber	Activated carbon
Belgium	BE	2		
Bulgaria	BG			
Czech Republic	CZ	1		
Denmark	DK		2	
Germany	DE	11		
Estonia	EE			
Greece	EL			
Spain	ES			
France	FR	3		
Ireland	IE			
Italy	IT	1		
Cyprus	CY			
Latvia	LV			
Lithuania	LT			
Luxembourg	LU			
Hungary	HU			
Malta	MT			
Netherlands	NL			
Austria	AT	1	1	
Poland	PL			
Portugal	PT	3		
Romania	Ro			
Slovenia	SI		1	
Slovakia	SK			
Finland	FI			
Sweden	SE		1	
United Kingdom	UK		2	
Norway	NO			
Switzerland	CH	1	1	1
Turkey	TR			
TOTAL		23	8	1

Source: [73, CEMBUREAU, 2006], [182, TWG CLM, 2008]

**Table 1.37: Abatement techniques for SO<sub>2</sub> reduction used in the EU-27 and EU-23+ countries in 2008**



No semi-wet and dry scrubbers are used in the European cement industry. The principle of these techniques is the neutralisation of SO<sub>2</sub> from the exhaust gas by the injection of chemical or physical sorption agents. The reaction products are dissolved or dry salts, following the techniques. In Untervaz, Switzerland in 2003, the only plant in Europe to have installed a circulating fluidised bed dry scrubber was shut down due to economic and, to a lesser extent, technical reasons.

#### 1.4.5.2.1 Absorbent addition

##### Description and achieved environmental benefits

Secondary emissions control techniques employed in the cement industry are hydrate-of-lime addition using the so-called 'dry additive process' (sorbent addition to raw material) or the 'dry sorption process' (sorbent injection into the gas stream). Hydrate-of-lime addition offers the additional advantage that the calcium-bearing additive forms reaction products that can be directly incorporated into the clinker burning process.

The optimum temperature ranges for hydrate-of-lime addition are 350 to 400 °C and below 150 °C if the gas is enriched with water. Suitable locations for hydrate-of-lime addition in cement rotary kiln systems are the upper cyclone stages or the raw gas duct.

Alternatively, hydrate-of-lime can be charged into the raw mill together with the raw material constituents or directly added to the kiln feed. Hydrate or slaked lime (Ca(OH)<sub>2</sub>), quicklime (CaO) or activated fly ash with a high CaO content, is injected into the exhaust gas path at temperatures close to the water dew point, which results in more favourable conditions for SO<sub>2</sub> capture. In cement kiln systems, this temperature range is available in the area between the raw mill and the dust collector. The hydrate-of-lime reacts with the SO<sub>2</sub> in the upper cyclone stages and is carried out of the system as raw gas dust (dust collector) which is returned to the downstream grinding-drying unit with the raw gas. Factors limiting the reduction efficiency of this process are the short gas retention times in the upper cyclone stages (minimum two seconds) and the high exhaust gas CO<sub>2</sub> levels of over 30 %.

##### Cross-media effects

Intensive lime injection impacts on raw meal quality.

##### Operational data

The SO<sub>2</sub> reduction potential of hydrate-of-lime addition is determined by the initial SO<sub>2</sub> level and the exhaust gas conditions on the one hand, and the concentration level of the sulphur cycles forming in the respective plant on the other. SO<sub>2</sub> reductions of 60 to 80 % can be achieved by absorbent injection in suspension preheater kiln systems. With initial levels not higher than 400 mg/Nm<sup>3</sup>, it is theoretically possible to achieve around 100 mg/Nm<sup>3</sup>. For initial SO<sub>2</sub> levels of up to 1200 mg/Nm<sup>3</sup>, it is possible to achieve a reduction to 400 mg/Nm<sup>3</sup>. Higher initial SO<sub>2</sub> levels above 1200 mg/Nm<sup>3</sup> require significant amounts of absorbent which might not be cost effective. Moreover, a higher initial concentration of the sulphur cycles leads to process upsets due to the formation of deposits in the calcining area. Therefore, there might be a risk of higher sulphur recirculation and kiln instability as higher levels of sulphur are returned to the kiln when this technique is applied.

##### Applicability

Absorbent addition is, in principle, applicable to all kiln systems, although it is mostly used in suspension preheaters. There is at least one long wet cement kiln injecting dry NaHCO<sub>3</sub> to the exhaust gas before the ESP is used to reduce peak emissions of SO<sub>2</sub>. Lime addition to the kiln feed reduces the quality of the granules/nodules and causes flow problems in Lepol kilns.

The dry sorption process (absorbent injection into the gas stream) can be applied in a dry or a wet form. For preheater kilns it has been found that direct injection of slaked lime into the exhaust gas is less efficient than adding slaked lime to the kiln feed. The SO<sub>2</sub> will react with the

lime to CaSO<sub>3</sub> and CaSO<sub>4</sub>, which then enters the kiln together with the raw material and is incorporated into the clinker. This technique is suitable for cleaning gas streams with moderate SO<sub>2</sub> concentrations and can be applied at an air temperature of more than 400 °C. The highest reduction rates can be achieved at temperatures exceeding 600 °C. It is recommended that a Ca(OH)<sub>2</sub> based absorbent with a high specific surface area and high porosity should be used. Slaked lime does not have a high reactivity, therefore Ca(OH)<sub>2</sub>/SO<sub>2</sub> molar ratios of between 3 and 6 have to be applied. Gas streams with high SO<sub>2</sub> concentrations require 6 – 7 times the stoichiometric amount of absorbent, implying high operational costs.

**Economics**

Absorbent addition is in use at several plants to ensure that the limits are not exceeded in peak situations. This means that, in general, it is not in continuous operation, but only when required by specific circumstances. With an initial SO<sub>2</sub> concentration of up to 3000 mg/Nm<sup>3</sup>, a reduction of up to 65 % and a slaked lime cost of EUR 85 per tonne, the investment costs for a 3000 tonne clinker/day preheater kiln are about EUR 0.2 million – 0.3 million and the operating costs are about EUR 0.1 – 0.4 per tonne clinker.

See also Table 1.36 and Section 1.4.8.3 where example cost data are shown.

**Driving force for implementation**

Legal requirements.

Local conditions.

**Example plants and reference literature**

Cement plants in the EU-27.

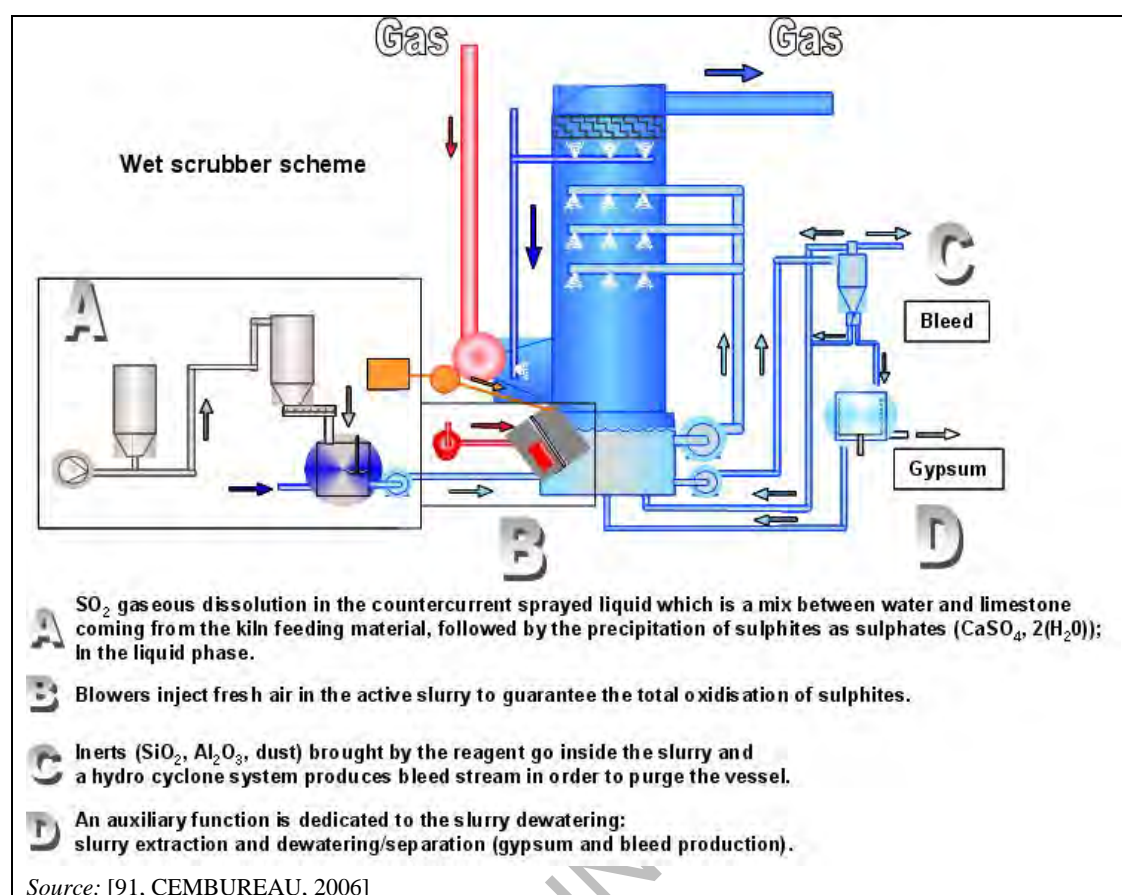
[8, CEMBUREAU, 2001], [9, CEMBUREAU, 1997 November], [12, Netherlands, 1997], [30, Marchal, 2001], [76, Germany, 2006], [97, CEMBUREAU, 2007], [101, France/ADEME/MEDD, 2002], [168, TWG CLM, 2007].

**1.4.5.2.2 Wet scrubber****Description and achieved environmental benefits**

The wet scrubber is the most commonly used technique for flue-gas desulphurisation in coal-fired power plants. For cement manufacturing processes, the wet process for reducing SO<sub>2</sub> emissions is an established technique. Wet scrubbing is based on the following chemical reaction:



The SO<sub>x</sub> is absorbed by a liquid/slurry which is sprayed in a spray tower. The absorbent is calcium carbonate. Wet scrubbing systems provide the highest removal efficiencies for soluble acid gases of all flue-gas desulphurisation (FGD) methods with the lowest excess stoichiometric factors and the lowest solid waste production rate. However, wet scrubbers also significantly reduce the HCl, residual dust and, to a lesser extent, metal and NH<sub>3</sub> emissions. The basic principle of the working system of a wet scrubber is shown in Figure 1.69.



**Figure 1.69: Basic operational features of a wet scrubber**

There are seven wet scrubbers currently in use in 2008 and one is planned to be used in the European cement industry, all of them spray towers. The slurry is sprayed in countercurrently to the exhaust gas and collected in a recycle tank at the bottom of the scrubber where the formed sulphite is oxidised with air to sulphate and forms calcium sulphate dihydrate. The dihydrate is separated and depending upon the physico-chemical properties of gypsum this material can be used in cement milling and the water is returned to the scrubber.

In comparison to the dry scrubber, the potential to generate cement kiln dust (CKD) in a wet process is much lower and natural gypsum recourses are saved. In Untervaz, Switzerland, the only installed circulating fluidised bed dry scrubber in Europe was retired in 2003, due to economic – and to a lesser extent – technical reasons. Normally, during the cement manufacturing process or from gas scrubbing applications, the aim is not to generate waste dust. In wet desulphurisation processes,  $\text{CaSO}_4 \cdot 2 \text{H}_2\text{O}$  is formed – which is used as a natural gypsum replacement and in the follow-up integrated as a modulating agent in the cement. In a dry/semi-dry desulphurisation process, a large quantity of the product  $\text{CaSO}_3 \cdot \frac{1}{2} \text{H}_2\text{O}$  is formed, the latter of which is harmful for the cement quality and integration possibilities in the cement are limited. The majority of the dry scrubber product would therefore have to be taken either back to the kiln or would need to be disposed of.

#### **Cross-media effects**

Increased energy consumption.

Increased waste production from flue-gas desulphurisation (FGD), and when maintenance is carried out, additional waste may occur.

Increased  $\text{CO}_2$  emissions (see the chemical reaction above where it is shown how  $\text{CO}_2$  is derived from the wet scrubber process)

Increased water consumption.

Emissions to water and increased risk of water contamination.

Increased operational cost.

Replacement of natural gypsum by artificial gypsum.

### Operational data

The SO<sub>2</sub> reduction achieved can be more than 95 %. Cementa AB in Sweden operates a 5800 tonne clinker/day preheater kiln and has an initial SO<sub>2</sub> concentration in the flue-gas of 800 – 1000 mg/Nm<sup>3</sup>, resulting in levels of <10 mg/Nm<sup>3</sup>. Castle Cement in the UK operates a 2500 tonne clinker/day preheater kiln and has an initial SO<sub>2</sub> concentration in the flue-gas of about 800 – 1400 mg/Nm<sup>3</sup> as a daily average with peak values of more than 2000 mg/Nm<sup>3</sup> at times. Furthermore, SO<sub>2</sub> emissions of 207 mg/Nm<sup>3</sup> as a yearly average over the years between 2002 and 2006 have been reported and the maximum daily averages have varied from 248 to 296 mg/Nm<sup>3</sup> due to the high sulphur content in the raw material.

### Applicability

A wet scrubber can be fitted to all cement kiln types with appropriate (sufficient) SO<sub>2</sub> levels in order to manufacture the gypsum.

### Economics

In 2008, capital expenditure costs for a wet scrubber of Ribblesdale works, Castle Cement in the UK, were estimated by the supplier to be around EUR 23 million, when considering inflation. In 2000, the investment costs for the scrubber of Castle Cement (including plant modifications) were reported to be EUR 7 million and the operating costs were about EUR 0.9 per tonne clinker. In 1998 for Cementa AB in Sweden, the investment costs were about EUR 10 million and the operating costs were about EUR 0.5 per tonne clinker. With an initial SO<sub>2</sub> concentration of up to 3000 mg/Nm<sup>3</sup> and a kiln capacity of 3000 tonne clinker/day, the investment costs in the late 1990s were EUR 6 million – 10 million and the operating costs EUR 0.5 – 1 per tonne clinker. Furthermore in 1998 at an Austrian cement plant, the investment costs for a wet scrubber (SO<sub>2</sub> emissions reduction to less than 200 mg/Nm<sup>3</sup>) were EUR 5.8 million and until 2008, the yearly operational costs were EUR 140000. In 2008, the European cement industry reported investment costs of between EUR 6 million and 30 million and operational costs of between EUR 1 – 2 per tonne clinker.

Example costs data along with a set of different data calculated for a reference plant with a capacity of 1100 t/d can be found in Table 1.41 in Section 1.4.8.3.

### Driving force for implementation

Legal requirements.

Local conditions.

### Example plants and reference literature

Cementa AB (Sweden), Castle Cement (UK), Retznei plant (Lafarge, Austria), Dunbar (UK), Trebovlje (Slovenia), Untervaz (Switzerland).

[8, CEMBUREAU, 2001], [9, CEMBUREAU, 1997 November], [10, Cementa AB/Hagström, 1994], [11, Coulburn, 2001], [24, Junker, 2001], [81, Castle Cement UK, 2006], [86, EURITS, 2006], [92, Austria, 2006], [103, CEMBUREAU, 2006], [114, Sweden, 2006], [132, CEMBUREAU/Federhen, 2007], [168, TWG CLM, 2007], [175, Lafarge, 2007], [182, TWG CLM, 2008], [183, Szednyj/Schindler, 2005].

#### 1.4.5.2.3 Activated carbon

##### Description and achieved environmental benefits

Pollutants such as SO<sub>2</sub>, organic compounds, metals, NH<sub>3</sub>, NH<sub>4</sub> compounds, HCl, HF and residual dust (after an ESP or fabric filter) may be removed from the exhaust gases by adsorption on activated carbon. The activated carbon filter is used for the injection technique or is constructed as a packed-bed with modular partition walls. The modular design allows the filter sizes to be adapted for different gas throughputs and kiln capacity. The used activated coke

is periodically extracted to a separate silo and replaced with fresh adsorbent. By using the saturated coke as fuel in the kiln, the trapped substances are returned to the system and to a large extent become fixed in the cement clinker.

### **Cross-media effects**

Wastes resulting from activated carbon have to be managed as hazardous wastes.

### **Operational data**

The only activated carbon filter still existing in the European cement industry is installed at a cement works in Siggenthal, Switzerland. The Siggenthal kiln is a four stage cyclone preheater kiln with a capacity of 2000 tonne clinker/day. Measurements showed high removal efficiencies for SO<sub>2</sub>, metals and PCDD/F. During a 100 days trial, the SO<sub>2</sub> concentrations at the filter inlet varied between 50 and 600 mg/Nm<sup>3</sup>, whereas the outlet concentrations were always significantly below 50 mg/Nm<sup>3</sup>. Dust concentrations dropped from 30 mg/Nm<sup>3</sup> to significantly below 10 mg/Nm<sup>3</sup>.

### **Applicability**

An activated carbon filter can be fitted to all dry kiln systems. Wastes, such as used activated carbon with PCDD/F and other pollutants like mercury, have to be managed as hazardous wastes. Monitoring and control of temperature and CO are especially important for such processes, to prevent fires in the coke filter.

### **Economics**

The system at Siggenthal also includes an SNCR process and in 1999, the city of Zürich financed about 30 % of the total investment cost of approximately EUR 15 million. The investment in this abatement system was made to enable the cement works to use digested sewage sludge as fuel.

Operating costs may increase.

### **Driving force for implementation**

Legal requirements.

Local conditions.

### **Example plants and reference literature**

Siggenthal, Switzerland

[9, CEMBUREAU, 1997 November], [10, Cementa AB/Hagström, 1994], [12, Netherlands, 1997], [86, EURITS, 2006], [168, TWG CLM, 2007], [182, TWG CLM, 2008].

#### **1.4.5.3 Reduction of carbon oxides (CO) emissions and CO trips**

##### **Description**

The kiln/raw mill exhaust gas contains, besides different other constituents such as CO<sub>2</sub>, N<sub>2</sub>, water vapour and oxygen and to a lesser extent NO and SO<sub>x</sub>, to a lesser extent also CO.

The selection, when possible, of raw materials with a low content of organic matter also reduces the emissions of CO. When resulting from incomplete combustion, carbon monoxide (CO) emissions generally represent a loss of efficiency. Therefore, the operator tends to limit the CO emissions of its kilns. Improvement in combustion such as optimisation and quality of the fuel feed, burner properties and configuration, kiln draft, combustion temperature and residence time can reduce CO emissions.

Furthermore, all techniques that reduce fuel energy use also reduce the CO<sub>2</sub> emissions. The selection, when possible, of raw materials with a low organic matter content and fuels with a low ratio of carbon content to calorific value reduces CO<sub>2</sub> emissions.

### *CO trips*

Dust emissions due to CO trips can occur at ESPs and, to some extent, at hybrid filters. ESPs will have to be shut down during elevated CO levels in the flue-gases for safety reasons.

In order to reduce ESP downtime, a systematic stepwise approach is needed:

- set objectives and assess the situation in respect of the main factors influencing CO trips, such as causes of CO trips due to the following:
  - process upset
  - high levels of background CO due to high organics in the raw material
  - disruption to the fuel feed system
  - combustion process upset
- compare and evaluate current and optimum situations, identification of optimisation potential and setting priorities – gap analysis
- optimisation of the process, the analysis system, ensuring availability, reliability and speed, optimisation of reaction techniques.

Furthermore, to identify any cause and address counter techniques, the following information is needed:

- information on reliability, availability and dynamic behaviour of analysing equipment
- information on CO development statistics
- information on the fuels used, the fuel feeding system and the process.

Fuel feeding systems, which are designed to prevent surges of fuel into the kiln system to keep a stable operation of the combustion system, can minimise CO trips.

In order to control the CO level in a cement kiln, an automatic CO measurement is used to continuously monitor CO from the flue-gases. This measure/technique needs to be optimised for reaction time as well as the shutdown procedure and needs to be properly maintained. The ideal CO monitoring system has a short response time and should be situated close to the source of the CO, such as at a preheater tower outlet, or at a kiln inlet in the case of a wet kiln application. Still, a dead time analysis of the entire system – including hold up time due to duct volume – needs to be carried out. Ideally the dead time for the CO gas sample to travel from the suction point to the analyser will be in the region of 20 – 30 seconds (analysing lag time). Adding an additional 10 – 30 seconds lag time, as the analysing reaction time, should give the total maximum dead time before approximately 85 % of the maximum value has been reached. The total dead time determines when action has to be taken – not too early and not too late. If a more detailed analysis of the slope of the CO signal is carried out, a more precise prediction can be made when the ESP high tension system has to be shut down and when it can be put back into full operation again – hence accounting for when the CO trip has left the critical area.

The CO monitoring lag time can be reduced by an increased sample flow, shortening the distance from the sampling point to the analyser, reduced volume in the analysing system and a quick electronic reporting signal. Rapid in situ systems with response times of <3 seconds are available, but these have limitations in high dust-laden gases. In general, a strict maintenance and calibration regime is essential. However, analyser ranges and components have to appropriately address critical limits of up to 5 % for CO and 3 % for CH<sub>4</sub>.

If the CO trip cannot be suppressed, any ignition sources, particularly the high tension equipment of the ESPs, require special attention. A trip of the high tension equipment as such is the last resort and is undesirable. Other potential ignition sources can be static loads caused by solid/solid friction or also fans, possible for any dust collector system. In general, the critical limit is >8 % CO or – CH<sub>4</sub> – in the presence of >6 % O<sub>2</sub>. In reality, the CO trip travels through the gas train swiftly and will reach the critical area for an ignition source before the analysing system is able to indicate an alarm. Therefore, the action level has to be significantly lower than

the theoretical level, and is further dependent on the CH<sub>4</sub> and H<sub>2</sub> concentrations, especially when natural gas is used as fuel.

Disruptions predominantly happen during the start-up operation phase. For safe operation, the gas analysers for ESP protection have to be on-line during all operational phases. Plant downtime can be reduced by using a backup system which is in operation.

#### Achieved environmental benefits

Reduction of explosion risks, CO trips, CO and dust (particulate matter) emissions.

#### Cross-media effects

Dust (particulate matter) emissions due to CO trips can occur.

#### Operational data

CO can be found in flue-gas at concentrations of up to 0.1 % with additional CO originating from carbon in the raw materials.

CO emissions of between 200 and 2200 mg/Nm<sup>3</sup> (yearly average value) have been reported from continuous measurements (see Figure 1.34 in Section 1.3.4.4.2).

CO trips can occur within a couple of minutes, or even seconds, rapidly reaching an operational interruption limit (see Sections 1.3.4.1.1 and 1.4.4.3.1). Frequencies of CO trips can be minimised and examples of total duration ranges of between 1 – 29 minutes per year, respectively <0.001 – 0.009 % of the total kiln operation have been reported (see Section 1.3.4.1.1) [158, Germany, 2007].

An example of primary techniques which can be used to prevent CO trips in ESPs is described in Table 1.38. Standard staged actions may firstly include reducing fuel feed and the high tension level. Thereafter, cutting the fuel feed entirely and tripping the high tension transformers automatically. The system then needs to be purged by keeping the fans in operation. The necessary purge time can be determined in the same way as the lag time.

Primary techniques to prevent CO trips		
Measuring point	CO level (%)	Measure
In a preheater tower	0.5	Alarm, shutdown of precalciner/kiln inlet firing system
	1.2	Shutdown of main firing system
	2.5	Shutdown of electric precipitator high tension
After a preheater tower	0.5	Alarm, shutdown of precalciner/kiln inlet firing system
	0.8	Shutdown of main firing system
	1.5	Shutdown of electric precipitator high tension
	0.5	Restart of ESP high tension equipment

*Source:* [60, VDI 2094 Germany, 2003], [83, CEMBUREAU, 2006]

**Table 1.38:** Example of primary techniques to prevent CO trips from ESPs

#### Applicability

Techniques for reducing CO trips can be applied to all kiln types.

By applying an automatic CO monitoring device for continuously monitoring the flue-gases on kilns with secondary firing, further operational reliability of the filters can be secured through sequential shutdown of the firing system during a CO trip.

The use of different fuels, especially solid fuels, can lead to unstable operation of the combustion system and can cause CO trips. The fuel feeding systems should be designed to prevent surges of fuel into the kiln system at any time. The conveying properties of solid fuels is

a particularly critical factor in this respect and must be carefully controlled to prevent hold ups or blockages in the fuel preparation and feeding systems.

### *Fabric filters*

Fabric filters operated in overcritical atmospheres may also experience problems. Therefore the operational CO level should also be kept as low as possible. As with ESPs, additional combustible gas components such as CH<sub>4</sub> and H<sub>2</sub> will lower the critical level, i.e. if hydrogen of approximately 2 % is present, the critical level is reduced to approximately 5 %.

Specific potential ignition sources for fabric filters can be static loads caused by the friction of man-made fibres or in the event of hybrid filters (combination of an ESP with a fabric filter) the accumulated static load on the bags. To prevent interruptions, especially for coal mills, bags are fitted with a stainless steel fibre mesh or a conducting surface and are grounded to the baghouse cell plate. Similarly for hybrid dust collectors, the grounding of the bag support cage with the cell plate is recommended. As with the ESP system, the CO has to be purged out. Purging of coal mills is preferably done by means of inert gas, such as kiln gas, CO<sub>2</sub> or N<sub>2</sub>.

### **Economics**

No data available.

### **Driving force for implementation**

Legal requirements.

Local conditions.

### **Example plants and reference literature**

Cement plants in the EU-27.

Guideline regarding the control of CO trips (see Section 6.2.6) [83, CEMBUREAU, 2006] [60, VDI 2094 Germany, 2003], [158, Germany, 2007], [168, TWG CLM, 2007], [182, TWG CLM, 2008].

## **1.4.5.4 Reduction of total organic carbon emissions (TOC)**

### **Description and achieved environmental benefits**

Under normal circumstances, emissions of volatile organic compounds (VOCs) are generally low but can be higher because of the organic volatile content in the raw material which is used at the plant. Natural or waste raw materials with a high content of volatile organic compounds should not, if a choice is possible, be fed into the kiln system via the raw material feeding route and fuels with a high content of halogens should not be used in a secondary firing.

If elevated concentrations of VOCs occur, adsorption on activated carbon can be considered as in other sectors.

### **Cross-media effects**

No issues.

### **Operational data**

TOC emissions reported from European cement kilns are in the range of between 1 and 40 mg/Nm<sup>3</sup> (yearly average values) and can be higher depending on the raw material characteristics (see Section 1.3.4.5).

When co-incinerating waste, the requirements of [Chapter IV of and Annex VI to the Directive 2010/75/EU](#) have to be met.

### **Applicability**

These techniques are, in principle, applicable to cement kilns.



**Economics**

No data provided.

**Driving force for implementation**

Legal requirements.

**Example plants and reference literature**

Cement plants in the EU-27.

[9, CEMBUREAU, 1997 November], [59, European Union, 2000], [76, Germany, 2006], [97, CEMBUREAU, 2007], [168, TWG CLM, 2007], [182, TWG CLM, 2008].

**1.4.5.5 Reduction of hydrogen chloride (HCl) and hydrogen fluoride (HF)****Description and achieved environmental benefits**

The use of raw materials and fuels containing low chlorine and low fluorine levels can reduce chlorine and fluorine emissions (see also Sections 1.4.3.2 and 1.4.3.3). Furthermore, the use of absorbent injection or scrubber techniques may also have an influence on HCl and HF emissions.

Chlorine compounds condense on the kiln feed or the kiln dust at temperatures of between 700 and 900 °C. They show a cyclic behaviour and may become enriched in the area between the rotary kiln and the preheater. The use of a bypass at the kiln inlet allows an effective reduction of alkali chloride cycles. Furthermore, the use of low levels of chlorine in the raw materials and fuels result in a low circulation of chlorine and can minimise the enrichment cycle resulting from the internal circulation between the kiln and preheater.

90 to 95 % of the fluorine which is present in rotary kilns is captured in the clinker, and the remainder is bound with dust in the form of calcium fluoride (CaF<sub>2</sub>) which is stable under the conditions of the burning process.

**Cross-media effects**

The use of a bypass system (removal of hot raw material and hot gas) leads to a higher specific energy consumption (see Section 1.4.2.1.4) and increased waste for disposal.

**Operational data**

Best performance data for HCl emissions in a range of between 0 and 8 mg/Nm<sup>3</sup> (yearly average value) were reported but depended on the chlorine content in raw materials and fuels (see Section 1.3.4.8.1).

Best performance data for HF emissions from cement kilns are below 0.6 mg/Nm<sup>3</sup> (yearly average value), expressed as HF (see also Section 1.3.4.8.2).

When co-incinerating waste, the requirements of [Chapter IV of and Annex VI to the Directive 2010/75/EU](#) have to be met.

**Applicability**

These techniques are, in principle, applicable to the cement industry.

**Economics**

No data available.

**Driving force for implementation**

Legal requirements.

Local conditions.

### Example plants and reference literature

Cement plants in the EU-27.

[59, European Union, 2000], [76, Germany, 2006], [97, CEMBUREAU, 2007], [168, TWG CLM, 2007], [182, TWG CLM, 2008].

## 1.4.6 Reduction of polychlorinated dibenzo-p-dioxin (PCDD) and polychlorinated dibenzofuran (PCDF) emissions

### Description and achieved environmental benefits

Cement kilns generally emit very low levels of PCDD/F emissions; however, general primary techniques can be applied to minimise them, such as:

- a smooth and stable kiln process, operating close to the process parameter set points, is beneficial for all kiln emissions as well as for the energy use. This can be obtained by applying:
  - process control optimisation including a computer-based automatic control system
  - use of modern fuel feed systems
- minimising fuel energy use by means of:
  - preheating and precalcination, considering the existing kiln system configuration
- careful selection and control of substances entering the kiln
  - selection and use of homogeneous raw materials and fuels with a low content of sulphur, nitrogen, chlorine, metals and volatile organic compounds, if practicable.

To minimise the possibility of PCDD/F reformation, the following primary techniques are considered to be the most important:

- quick cooling of kiln exhaust gases to lower than 200 °C in long wet and long dry kilns without preheating. In modern preheater and precalciner kilns, this feature is already inherent
- limitation or avoidance of waste used as raw material feed as part of the raw material mix, if it includes organic chlorinated materials
- not using waste fuel feeding during start-ups and shutdowns
- monitoring and stabilisation of critical process parameters, i.e. homogenous raw mix and fuel feed, regular dosage and excess oxygen [86, EURITS, 2006], [88, SINTEF, 2006]
- fuels with a high content of halogens should not be used in a secondary firing.

However, if elevated concentrations of PCDD/PCDF occur, adsorption on activated carbon can be considered as in other sectors.

### Cross-media effects

Using exhaust gas quench systems which consist of a water spray system within the flue duct may have an influence on the energy efficiency.

### Operational data

Most cement kilns can meet an emission level of 0.1 ng I-TEQ/Nm<sup>3</sup> if primary techniques are applied [88, SINTEF, 2006]. In 2004, spot measurements showed that high numbers of all kilns in the EU-27 and EU-23+ countries achieve emission levels of between <0.03 and 0.05 ng I-TEQ/Nm<sup>3</sup> by applying primary techniques (see Figure 1.39 in Section 1.3.4.6). Furthermore, emission levels of <0.03 ng I-TEQ/Nm<sup>3</sup> as yearly average values were achieved by many cement plants (see Figure 1.38 in Section 1.3.4.6).

### Applicability

These techniques are, in principle, applicable to cement kilns. In wet kilns, controlling post-kiln operating conditions can minimise PCDD/F emissions.

**Economics**

No data provided.

**Driving force for implementation**

Legal requirements.

Local conditions.

**Example plants and reference literature**

Cement plants in the EU-27.

[86, EURITS, 2006], [88, SINTEF, 2006], [168, TWG CLM, 2007], [182, TWG CLM, 2008].

**1.4.7 Reduction of metal emissions****Description and achieved environmental benefits**

Feeding materials with a high content of volatile metals into the kiln system should be avoided. The use of materials with a high content of volatile metals such as Hg and Tl should especially be controlled because they will lead to higher emissions whereas other metals will be found within the clinker and the dust. Careful selection and guaranteed characteristics of substances entering the kiln can reduce emissions, e.g. using a quality assurance system to guarantee the characteristics of the waste materials used (see Sections 1.4.3.2 and 1.4.3.3).

The accumulation of metals, especially thallium, in the internal and external cycles of a cement kiln system results in an increase of emissions with increasing kiln operating time. This can be reduced by partly or completely interrupting these cycles. However, the close interconnection between internal and external cycles means it is sufficient to interrupt only the external cycle. This can be done by discarding the dust collected in the dust collector, instead of returning it to the raw meal. When its chemical composition is suitable, this discarded cement kiln dust can be added directly to the cement milling stage [27, University of Karlsruhe, 1996].

As the emitted metals (except part of the mercury) are, to a large extent, bound to dust, abatement strategies for metals are covered by abatement strategies for dust. Effective dust removal reduces metal emissions. One way to minimise mercury emissions is to lower the exhaust temperature. Non-volatile elements remain within the process and exit the kiln as part of the cement clinker composition. When high concentrations of volatile metals (especially mercury) occur, the volatile metals content (especially mercury) in the materials has to be minimised and it can be necessary to limit the input of these substances into the kiln system (see Sections 1.3.4.13, 1.4.3.2 and 1.4.3.3).

Furthermore, absorption on activated carbon is an option. Semi-volatile metals condense as fine fumes and are captured but with a lower removal efficiency than for non-volatile metals. When non-volatile metals are introduced into the kiln system they are, to a great extent, captured within the clinker (see Section 1.3.4.7).

**Cross-media effects**

Effective dust removal also reduces metal emissions.

**Operational data and applicability**

By using powdered activated carbon injection, mercury is adsorbed by activated carbon. Removal efficiency for mercury (metallic and ionic) of about 85 and 95 % is reported for this measure/technique. This results in Hg emissions of 0.01 – 0.03 mg/Nm<sup>3</sup>. However, there is no industrial reference method for this measure/technique.

The static activated carbon or coke filter involves the adsorption of mercury with PCDD/F on the activated carbon filter that is a packed-bed with modular partition walls. The use of this measure/technique provides Hg emissions of below 0.03 mg/Nm<sup>3</sup>. The filter has to be periodically replaced when it is saturated. Wastes, such as used activated carbon with PCDD/F

and other pollutants like mercury, is hazardous waste and has to be managed as such [86, EURITS, 2006].

However, there is only one activated carbon filter in use in EU-23+ countries which is in Siggental in Switzerland (see Section 1.4.5.2.3).

Furthermore, mercury emissions of between  $<0.01 - 0.05 \text{ mg/Nm}^3$  were also achieved without the injection of activated carbon as shown in Figure 1.46 (spot measurements) and Figure 1.47 (yearly average values, see Section 1.3.4.7.1).

When co-incinerating waste, the requirements of **Chapter IV of and Annex VI to the Directive 2010/75/EU** have to be met.

### **Economics**

A required quality assurance system to guarantee the characteristics of materials fed to the kiln may result in additional costs.

Effective dust removal can avoid high costs for activated carbon filters.

For the Siggental plant in Switzerland, the City of Zurich financed about 30 % of the total investment cost of approximately EUR 15 million.

### **Driving force for implementation**

Legal requirements.

### **Example plants**

Siggental, Switzerland

### **Reference literature**

[27, University of Karlsruhe, 1996], [59, European Union, 2000], [86, EURITS, 2006], [168, TWG CLM, 2007], [182, TWG CLM, 2008].

## **1.4.8 Examples of cost data for different flue-gas abatement techniques and primary techniques which can be used for emissions reductions**

### **1.4.8.1 Example cost data for dust abatement techniques**

Table 1.39 shows examples of cost calculations for dust abatement techniques. Different dust abatement techniques have been considered for investigation, such as ESPs and fabric filters. Variable operating costs include electricity, labour and dust disposal costs and are described separately within this table. Furthermore, key characteristics for different fabric filters along with cost schedules can be found in Section 1.4.4.3.2, where the technical applications of fibres are shown in Table 1.32. The information in Table 1.32 is compiled from 2003 and will be subject to local fixed costs with regards to energy and labour. It has to be noted that in Table 1.32 no account is taken of the replacement costs for filter media in the fabric filters.

Investments and costs of dust abatement techniques					
Parameter	Unit	Abatement measure/technique			
		ESP		Fabric filter	
Description of reference installation		I <sup>(0)</sup>	II	I <sup>(0)</sup>	II
Capacity	t of clinker/d	1100	3000	1100	3000
Lifetime	yr	35		35	
Plant factor	h/yr	7680		7680	
<b>Investment costs</b>	k EUR	1500	2100 – 4600 <sup>(8)</sup> 4500 – 6000 <sup>(9)</sup>	1750	2100 – 6800 <sup>(10)</sup> 4000 – 8000 <sup>(11)</sup>
<b>Annualised capital costs</b>	k EUR				
Interest rate	%/100/yr	4		4	
Lifetime of the control equipment	yr	10		10	
Total	k EUR	184.94		215.76	
Total	k EUR/tonne clinker	5.25E-04		6.13E-04	
<b>Fixed operating costs</b>	%/yr <sup>(2)</sup>	4		4	
Total	k EUR	60		70	
Total	k EUR/tonne clinker	1.70E-04		1.99E-04	
<b>Variable operating costs</b>	k EUR/tonne clinker	3.15E-04		3.77E-04	
<b>Costs per tonne clinker</b>	k EUR/tonne clinker	1.01E-03		1.19E-03	
<b>Costs per tonne PM<sup>(3)</sup> abated</b>	k EUR/t PM abated				
Unabated emissions factor <sup>(1)</sup>	t PM/t clinker	0.13 56.520 mg/Nm <sup>3</sup>		0.13 56.520 mg/Nm <sup>3</sup>	
Abated emissions factor <sup>(1)</sup>	t PM/t clinker	0.000046 20 mg/Nm <sup>3</sup>		0.000046 20 mg/Nm <sup>3</sup>	
Total	k EUR/t PM abated	0.008		0.009	
<b>Total operating costs</b>	EUR/t clinker		0.1 – 0.3		0.1 – 0.35
<b>Determination of the variable operating cost</b>					
<b>Electricity costs<sup>(4)</sup></b>					
Additional electricity demand ( $\lambda^e$ ) <sup>(5)</sup>	kWh/t clinker	4.15 190 kW		5.24 240 kW	
Electricity price ( $c^e$ )	EUR/kWh	0.0569		0.0569	

Investments and costs of dust abatement techniques					
Parameter	Unit	Abatement measure/technique			
		ESP		Fabric filter	
Total	k EUR/tonne clinker	2.36E-04		2.98E-04	
<b>Labour costs<sup>(6)</sup></b>					
Labour demand ( $\lambda^1$ )	man-year/t clinker	2.13E-06		2.13E-06	
Wages ( $c^1$ )	k EUR/man-year	37.234		37.234	
Total	k EUR/tonne clinker	7.93E-05		7.93E-05	
<b>Dust disposal costs<sup>(7)</sup></b>					
Total	k EUR/tonne clinker	0		0	
<b>Total variable operating costs</b>	k EUR/tonne clinker	3.15E-04		3.66E-04	

k EUR = EUR thousand  
<sup>(6)</sup> 2000 data, reference cement plant with a capacity of 1100 tonnes per day representing the average of the EU-15 in 1995  
<sup>(1)</sup> 10 % O<sub>2</sub> and dry gas  
<sup>(2)</sup> Of investment  
<sup>(3)</sup> Repartition 50 % of ESP and 50 % of fabric filter; use of average between ESP and fabric filter  
<sup>(4)</sup> Electricity costs =  $\lambda^2 \cdot c^2 / 10^3$  (k EUR/t)  
<sup>(5)</sup> Additional electricity demand = new total consumption - old total consumption  
<sup>(6)</sup> Labour costs =  $\lambda^1 \cdot c^1$  (k EUR/t)  
<sup>(7)</sup> Dust disposal costs =  $\lambda^d \cdot c^d \cdot ef_{unabated} \cdot \eta / 10^3$  (k EUR/t)  
 $ef_{unabated}$ : unabated emissions factor of pollutant (t pollutant/t)  
 $\lambda^d$ : demand for dust disposal (t/t pollutant removed)  
 $c^d$ : specific dust disposal cost (EUR/t)  
 $\eta$ : removal efficiency (=1- $ef_{abated}/ef_{unabated}$ )  
<sup>(8)</sup> 2000 data, includes investment costs for conditioning tower and filter fan (EUR 0.6 million – 0.8 million)  
<sup>(9)</sup> 2006 data  
<sup>(10)</sup> Includes investment costs for conditioning tower and filter fan (EUR 0.6 million – 0.8 million)  
<sup>(11)</sup> For separation efficiency >99.9 %, depending on type and number of filter bags used  
Source: [9, CEMBUREAU, 1997 November], [76, Germany, 2006], [100, France, 2006], [102, France/DFIU/IFARE Karlsruhe, 2003], [103, CEMBUREAU, 2006], [168, TWG CLM, 2007], [182, TWG CLM, 2008]

**Table 1.39: Examples of cost data for dust abatement techniques**

#### 1.4.8.2 Example cost data for NO<sub>x</sub> abatement techniques

Table 1.40 shows examples of cost calculations for NO<sub>x</sub> abatement techniques for a reference cement plant with a capacity representing the average of the EU-15 in 1995 (1100 t/d) and example plants with different capacities. The investigated NO<sub>x</sub> abatement techniques are SNCR, SCR and NO<sub>x</sub> primary techniques. Variable operating costs include electricity and labour costs and costs for ammonia used for SNCR are described separately within this table.

Furthermore, comparison of costs for the NO<sub>x</sub> abatement techniques of SNCR versus SCR by German UBA for a German plant can be found in Section 6.2.4.2, Table 6.26. Both investment and operating costs were calculated for different NO<sub>x</sub> levels which were achieved, i.e. 200 and 500 mg/Nm<sup>3</sup>. As shown from Table 6.26, the operating costs for SNCR and SCR - including replacement costs for the catalyst - are roughly the same for a target NO<sub>x</sub> level of 500 mg/Nm<sup>3</sup>, while the total specific costs for SCR are approximately 50 % higher than for SNCR. At a target NO<sub>x</sub> level of 200 mg/Nm<sup>3</sup>, SCR seems to be more efficient regarding operating costs, but the total specific costs are still at the same level of magnitude as for SNCR [76, Germany, 2006].

Investments and costs of NO <sub>x</sub> abatement techniques						
Parameter	Unit	Abatement measure/technique <sup>(1)</sup>				
		NO <sub>x</sub> primary measures/techniques <sup>(0)</sup>	Flame cooling <sup>(8)</sup>	Staged <sup>(7)</sup> combustion	SNCR <sup>(0)</sup>	SCR
<b>Description of reference Installation</b>						
Capacity	t of clinker/d	1100	3000	3000	1100	1500 <sup>(7)</sup>
Capacity	t of clinker/yr	352 000				
Lifetime	yr	35			35	
Plant factor	h/yr	7680			7680	
<b>Investment costs</b>	EUR million	0.25	up to 0.2	0.1 – 2 <sup>(8)</sup> 1 – 4 <sup>(9)</sup> 15 – 20 <sup>(10)</sup>	0.6	
<b>Specific investment costs</b>	EUR/t clinker				0.08 – 0.14 <sup>(7)</sup>	0.83 – 0.87 <sup>(7)</sup>
<b>Annualised capital costs</b>	k EUR					
Interest rate	%/100/yr	4			4	
Lifetime of the control equipment	yr	8			10	
Total	k EUR	37.13			166.97	
Total	k EUR/ t clinker	1.05E-04	up to 2.5E-04		4.74E-04	
<b>Fixed operating costs</b>	%/yr <sup>(2)</sup>	4			4	
Total	k EUR	10			24	
Total	k EUR/ t clinker	2.84E-05			6.82E-05	
<b>Variable operating costs</b>	k EUR/ t clinker	2.64E-05			5.69E-04	
<b>Costs per tonne clinker</b>	k EUR/t clinker	1.60E-04			1.11E-03	
<b>Costs per tonne NO<sub>x</sub><sup>(3)</sup> abated</b>	k EUR/t NO <sub>x</sub> abated				330 – 450 <sup>(7)</sup>	470 – 540 <sup>(7)</sup>
Unabated emissions factor <sup>(1)</sup>	t NO <sub>x</sub> /t clinker	0.00322 1400 mg/Nm <sup>3</sup>			0.002415 1050 mg/Nm <sup>3</sup>	
Abatement efficiency <sup>(1)</sup>	%	25			62	
Total	k EUR/t NO <sub>x</sub> abated	0.2			0.74	
<b>Catalysts Replacement costs</b>	EUR/t clinker					0.10 – 0.13 <sup>(7)</sup>
<b>Determination of the variable operating costs</b>						
<b>Electricity costs<sup>(3)</sup></b>						
Additional electricity demand (λ <sup>e</sup> ) <sup>(4)</sup>	kWh/t clinker	0.44 20 kW			0.13 5.96 kW	
Electricity price (c <sup>e</sup> )	EUR/kWh	0.0569			0.0569	
Total	k EUR/ t clinker	2.48E-05			7.40E-06 0.03 – 0.06 <sup>(7)</sup>	0.10 – 0.11 <sup>(7)</sup>
<b>Ammonia costs<sup>(6)</sup></b>						
NH <sub>3</sub> water storage	EUR million					
e <sub>f</sub> <sup>unabated</sup>	t pollutant/ t clinker	-			0.002415	

Investments and costs of NO <sub>x</sub> abatement techniques						
Parameter	Unit	Abatement measure/technique <sup>(1)</sup>				
		NO <sub>x</sub> primary measures/techniques <sup>(0)</sup>	Flame cooling <sup>(8)</sup>	Staged <sup>(7)</sup> combustion	SNCR <sup>(9)</sup>	SCR
NH <sub>3</sub> /NO <sub>x</sub> (mol/mol) ratio for NO <sub>x</sub> emitted		-			1.5	
Specific NH <sub>3</sub> demand (λ <sup>5</sup> )	t/t pollutant removed	-			0.89	
NH <sub>3</sub> price (c <sup>5</sup> )	EUR/t	-			0.26 – 0.64 <sup>(7)</sup> 400	0.13 – 0.26 <sup>(7)</sup>
Removal efficiency (η)	%	-			62	
Total	k EUR/ t clinker	-			5.36E-04	
<b>Labour costs<sup>(5)</sup></b>						
Labour demand (λ <sup>1</sup> )	man-year/ t clinker	7.10E-07			7.10E-07	
Wages (c <sup>1</sup> )	k EUR/ man-year	37.234			37.234	
Total	k EUR/ t clinker	2.64E-05			2.64E-05	
<b>Total variable operating costs</b>	k EUR/t	2.48E-05			5.69E-04 0.30 – 0.70 <sup>(7)</sup>	0.33 – 0.70 <sup>(7)</sup>
<b>Total costs (investment and operating)</b>	EUR/ tclinker				0.38 – 0.62 <sup>(7)</sup> 0.85 <sup>(11)</sup>	0.83 – 0.87 <sup>(7)</sup> 2.3 <sup>(11)</sup>

k EUR = EUR thousand  
<sup>(0)</sup> 2000 data, reference cement plant with a capacity of 1100 tonnes per day representing the average of the EU-15 in 1995  
<sup>(1)</sup> 10 % O<sub>2</sub> and dry gas  
<sup>(2)</sup> Of investment  
<sup>(3)</sup> Electricity costs = λ<sup>e</sup> • c<sup>e</sup>/10<sup>3</sup> (k EUR/t)  
<sup>(4)</sup> Additional electricity demand = new total consumption - old total consumption  
<sup>(5)</sup> Labour costs = λ<sup>l</sup> • c<sup>l</sup> (k EUR/t)  
<sup>(6)</sup> Ammonia costs = λ<sup>d</sup> • c<sup>d</sup> • ef<sub>unabated</sub> • η/10<sup>3</sup> (k EUR/t)  
 Ef<sub>unabated</sub>: unabated emissions factor of pollutant (t pollutant/t)  
 λ<sup>d</sup>: specific NH<sub>3</sub> demand (t/t pollutant removed)  
 c<sup>d</sup>: specific dust disposal cost (EUR/t)  
 η: removal efficiency (=1-ef<sub>abated</sub>/ef<sub>unabated</sub>)  
<sup>(7)</sup> Germany, depends on level of NO<sub>x</sub> reduction to 500 or 200 mg/Nm<sup>3</sup>  
<sup>(8)</sup> Precalciner kiln  
<sup>(9)</sup> Precalciner and the tertiary duct for a 3000 t/d preheater kiln with a grate cooler into a precalciner kiln  
<sup>(10)</sup> Transformation of a 3000 t/d preheater kiln with a satellite cooler into a precalciner kiln with a grate cooler  
<sup>(11)</sup> Austria  
 Source: [76, Germany, 2006], [85, CEMBUREAU, 2006], [100, France, 2006], [102, France/DFIU/IFARE Karlsruhe, 2003], [105, YARA, 2006], [168, TWG CLM, 2007], [182, TWG CLM, 2008]

**Table 1.40: Examples of costs for NO<sub>x</sub> abatement techniques**

### 1.4.8.3 Example cost data for SO<sub>x</sub> abatement techniques

Table 1.41 shows examples of cost calculations for SO<sub>x</sub> abatement techniques for a reference cement plant with a capacity of 1100 t/d. The investigated SO<sub>x</sub> abatement techniques are injection of absorbent and/or wet scrubbers. Variable operating costs include electricity and labour costs, and waste disposal and lime costs are described separately within this table.



Investment and operating costs of SO <sub>x</sub> abatement techniques			
	Unit	Abatement measure/technique	
		Absorbent injection <sup>(0)</sup>	Wet scrubber 75 % <sup>(0)</sup>
<b>Description of reference installation</b>			
Capacity	t of clinker/d	1100	1100
Capacity	t of clinker/yr	352000	352000
Exhaust gas flow <sup>(1)</sup>	Nm <sup>3</sup> /h		105417
Lifetime	yr	35	35
Plant factor	h/yr	7680	7680
<b>Investment costs</b>	k EUR	200	5500
<b>Annualised capital costs</b>	k EUR		
Interest rate	%/100/yr	4	4
Lifetime of the control equipment	yr	10	10
Total	k EUR	24.66	678.10
Total	k EUR/t clinker	7.01E-05	1.93E-03
<b>Fixed operating costs</b>	%/yr <sup>(2)</sup>	4	4
Total	k EUR	8	220
Total	k EUR/t clinker	2.27E-05	6.25E-04
<b>Variable operating costs</b>	k EUR/t clinker	6.98E-04	6.06E-04
<b>Costs per tonne of clinker</b>	k EUR/t clinker	7.91E-04	3.16E-03
<b>Costs per tonne of SO<sub>x</sub> abated</b>	k EUR/t SO <sub>x</sub> abated		
Unabated emissions factor	t SO <sub>x</sub> /t clinker	0.0023	0.00368
		1000 mg/Nm <sup>3</sup>	1600 mg/Nm <sup>3</sup>
Abatement efficiency	%	60	75
Total	k EUR/t SO <sub>x</sub> abated	0.573	1.144
<b>Determination of the variable operating costs</b>			
<b>Electricity costs<sup>(3)</sup></b>			
Additional electricity demand (λ <sup>(4)</sup> )	kWh/t of clinker	1.53	8.18
		70 kW	375 kW
Electricity price (c <sup>(5)</sup> )	EUR/kWh	0.0569	0.0569
Total	k EUR/t clinker	8.69E-05	4.66E-04
<b>Waste disposal costs</b>			
Unabated emissions factor of pollutant (ef <sub>unabated</sub> <sup>(6)</sup> )	t pollutant/t clinker	0.0023	-
Demand for waste disposal (λ <sup>(5)</sup> )	t/t pollutant removed	0	-
Specific waste disposal costs (c <sup>(5)</sup> )	EUR/t		-
Removal efficiency (η)	%	60	-
Total	k EUR/t clinker	0	0
<b>Lime costs/limestone costs</b>			
Unabated emissions factor of pollutant (ef <sub>unabated</sub> <sup>(6)</sup> )	t pollutant/t clinker	0.0023	0.00368
	Ca/S (mol/mol) ratio for SO <sub>x</sub> emitted	2.2	
	Ca/S (mol/mol) ratio for SO <sub>x</sub> removed		1.02
Specific sorbent demand (λ <sup>(5)</sup> )	t lime/t pollutant removed	4.24	-
Specific limestone demand (λ <sup>(5)</sup> )	t lime/t pollutant removed		1.59
Sorbent price (c <sup>(5)</sup> )	EUR/t	100	20
Removal efficiency (η)	%	60	75
Total	k EUR/t clinker	5.85E-05	8.80E-05
<b>Labour costs<sup>(7)</sup></b>			
Labour demand (λ <sup>(1)</sup> )	man-year/t clinker	7.10E-07	1.42E-06
Wages (c <sup>(1)</sup> )	k EUR/man-year	37.234	37.234

Investment and operating costs of SO <sub>x</sub> abatement techniques			
	Unit	Abatement measure/technique	
		Absorbent injection <sup>(0)</sup>	Wet scrubber 75 % <sup>(0)</sup>
Total	k EUR/t clinker	2.64E-05	5.29E-05
<b>Total variable operating costs</b>	k EUR/t clinker	6.98E-04	6.06E-04
k EUR = EUR thousand <sup>(0)</sup> 2000 data, reference cement plant with a capacity of 1100 tonnes per day representing the average of the EU-15 in 1995 <sup>(1)</sup> 10 % O <sub>2</sub> and dry gas <sup>(2)</sup> Of investment <sup>(3)</sup> Electricity costs = $\lambda^e \cdot c^e / 10^3$ (k EUR/t) <sup>(4)</sup> Additional electricity demand = new total consumption - old total consumption <sup>(5)</sup> Labour costs = $\lambda^l \cdot c^l$ (k EUR/t) <sup>(6)</sup> Lime costs = $\lambda^s \cdot c^s \cdot ef_{unabated} \cdot \eta / 10^3$ (k EUR/t) $ef_{unabated}$ : unabated emissions factor of pollutant (t pollutant/t) $\lambda^s$ : specific lime demand (t/t pollutant removed) $c^s$ : lime price (EUR/t) $\eta$ : removal efficiency (=1- $ef_{abated}/ef_{unabated}$ ) Source: [100, France, 2006], [102, France/DFIU/IFARE Karlsruhe, 2003], [168, TWG CLM, 2007]			

**Table 1.41: Example of costs for SO<sub>x</sub> abatement techniques**

### 1.4.9 Process losses/waste

#### Description

Collected dust can be recycled back into the production processes whenever practicable. This recycling may take place directly into the kiln or kiln feed (the alkali metal content being the limiting factor) or by blending with finished cement products. Alternative uses may be found for material that cannot be recycled.

#### Achieved environmental benefits

Reduction of waste materials occurring from the process along with raw material savings.

#### Cross-media effects

The content of metals in the collected dust is the limiting factor for using collected dust as raw material and can have a negative effect on metal emissions.

Furthermore, the content of chlorine in the collected dust is a limiting factor for the use of collected dust and the recycling has to be adapted to comply with product quality requirements (kiln feed or blending with finished cement products).

#### Operational data

No data provided.

#### Applicability

The re-use of process losses/waste is, in principle, applicable in the cement industry (see Section 1.3.5).

#### Economics

No data provided.

#### Driving force for implementation

Legal requirements.

#### Example plants and reference literature

Cement plants in the EU-27.

[86, EURITS, 2006], [88, SINTEF, 2006], [75, Estonia, 2006], [103, CEMBUREAU, 2006], [168, TWG CLM, 2007].

#### 1.4.10 Noise

##### **Description**

This section deals with possibilities for the reduction of noise occurring in several steps of the cement manufacturing processes.

A reduction of noise emissions can often be achieved by directly applying techniques at the source of the noise. Sources of noise are, for example, extraction and processing of raw material as well as cement/clinker production, crushing units, grinding and preparation units, the cement kilns themselves, e.g. cement finishing mills, belt conveyors, filter units, the cooling systems of the kilns, such as satellite coolers, etc. Noise emissions occur throughout the whole process chain from blowing in the quarry to shipping of the final products.

Various techniques for noise abatement can be applied at cement plants in order to reduce the noise levels for neighbourhood protection, such as:

- enclosure of the noisy unit
- vibration insulation of units
- using internal and external lining made of resistant material for chutes
- soundproof buildings to shelter any operations involving material transformation equipment
- building up noise protection walls
- outlet silencers for exhaust stacks
- lagging of ducts and finally blowers which are situated in soundproofed buildings.

If the above-mentioned noise protection techniques cannot be applied and if a transfer of noisy units inside a building is not possible, e.g. because of the sizes of kilns and their facilities, secondary noise protection techniques, e.g. construction of buildings or natural barriers, such as growing trees and bushes between the protected area and the noisy activity, e.g. the kiln or the storage area, have to be carried out. Doors and windows of covered areas have to be kept closed during noisy operations.

##### **Achieved environmental benefits**

Reduction of noise emissions.

##### **Cross-media effects**

No issues.

##### **Operational data**

No data available.

##### **Applicability**

Techniques for noise reduction can, in principle, be applicable in the cement industry (see Section 1.3.7).

##### **Economics**

Additional investment and maintenance costs can occur due to the noise protection techniques.

##### **Driving force for implementation**

Legal requirements.

##### **Example plants and reference literature**

Cement plants in the EU-27.

More information about noise abatement and a noise abatement scheme can be found in the lime chapter, Section 2.4.10.

[45, Schorcht, 2006] [81, Castle Cement UK, 2006] [168, TWG CLM, 2007].

### 1.4.11 General considerations for odours

Odours caused by hydrocarbon emissions can be avoided by thermal after-burning, use of an activated carbon filter or by feeding the raw material responsible to the hot zone of the kiln.

If odours are caused by sulphur compounds, a change of fuel and/or raw material can be a solution, also see Section 1.4.5.2.

Odours can also be caused by the storage of wastes which are used as raw materials or fuels. Storage places of waste materials can be covered or waste storage systems can be used.

### 1.4.12 Environmental management tools

**\*\*NOTE to Article 13 Forum members: The original text of this section has been deleted and replaced with the new standard text for EMS\*\***

#### **Description**

A formal system to demonstrate compliance with environmental objectives.

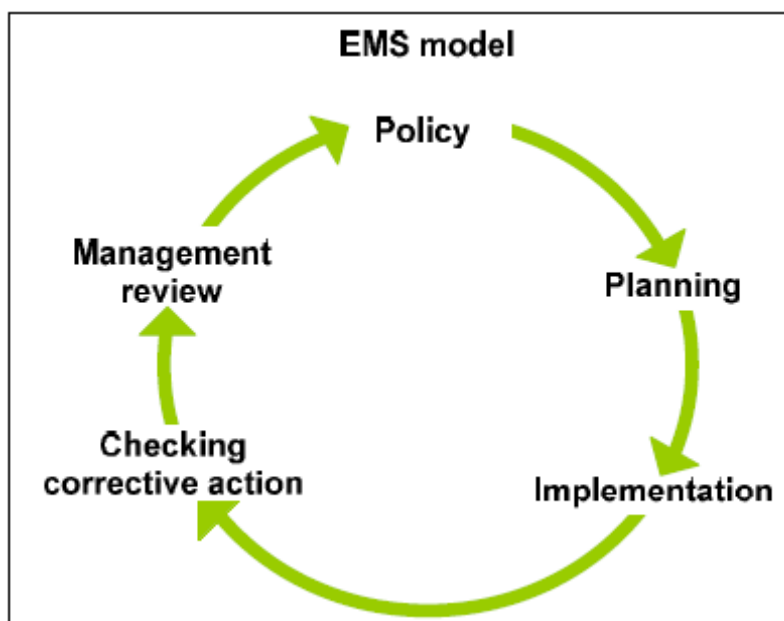
#### **Technical description**

The Directive defines 'techniques' (under the definition of 'best available techniques') as 'both the technology used and the way in which the installation is designed, built, maintained, operated and decommissioned'.

In this respect, an environmental management system (EMS) is a technique allowing operators of installations to address environmental issues in a systematic and demonstrable way. EMSs are most effective and efficient where they form an inherent part of the overall management and operation of an installation.

An EMS focuses the attention of the operator on the environmental performance of the installation; in particular through the application of clear operating procedures for both normal and other than normal operating conditions, and by setting out the associated lines of responsibility.

All effective EMSs incorporate the concept of continuous improvement, meaning that environmental management is an ongoing process, not a project which eventually comes to an end. There are various process designs, but most EMSs are based on the plan-do-check-act cycle (which is widely used in other company management contexts). The cycle is an iterative dynamic model, where the completion of one cycle flows into the beginning of the next (see Figure 1.70).



**Figure 1.70: Continuous improvement in an EMS model**

An EMS can take the form of a standardised or non-standardised ('customised') system. Implementation and adherence to an internationally accepted standardised system, such as EN ISO 14001:2004, can give higher credibility to the EMS especially when subjected to a properly performed external verification. EMAS provides additional credibility due to the interaction with the public through the environmental statement and the mechanism to ensure compliance with the applicable environmental legislation. However, non-standardised systems can, in principle, be equally effective provided that they are properly designed and implemented.

While both standardised systems (EN ISO 14001:2004 or EMAS) and non-standardised systems apply in principle to **organisations**, this document takes a narrower approach, not including all activities of an organisation, e.g. with regard to their products and services, due to the fact that the Directive only regulates **installations/plants**.

An EMS can contain the following components:

1. commitment of management, including senior management;
2. definition of an environmental policy that includes the continuous improvement of the installation by the management;
3. planning and establishing the necessary procedures, objectives and targets, in conjunction with financial planning and investment;
4. implementation of procedures paying particular attention to:
  - (a) structure and responsibility
  - (b) training, awareness and competence
  - (c) communication
  - (d) employee involvement
  - (e) documentation
  - (f) efficient process control
  - (g) maintenance programmes
  - (h) emergency preparedness and response
  - (i) safeguarding compliance with environmental legislation;
5. checking performance and taking corrective action paying particular attention to:
  - (a) monitoring and measurement (see also the Reference Document on the General Principles of Monitoring) [151, European Commission, 2003].

- (b) corrective and preventive action
  - (c) maintenance of records
  - (d) independent (where practicable) internal and external auditing in order to determine whether or not the EMS conforms to planned arrangements and has been properly implemented and maintained;
6. review of the EMS and its continuing suitability, adequacy and effectiveness by senior management;
  7. preparation of a regular environmental statement;
  8. validation by a certification body or an external EMS verifier;
  9. following the development of cleaner technologies;
  10. consideration for the environmental impacts from the eventual decommissioning of the installation at the stage of designing a new plant, and throughout its operating life;
  11. application of sectoral benchmarking on a regular basis.

### **Achieved environmental benefits**

An EMS promotes and supports the continuous improvement of the environmental performance of the installation. If the installation already has a good overall environmental performance, an EMS helps the operator to maintain the high performance level.

### **Environmental performance and operational data**

All significant consumptions (including energy) and emissions are managed in a coordinated manner by the operator for the short, medium and long term, in conjunction with financial planning and investment cycles. This means that e.g. adapting short-term end-of-pipe solutions to emissions may tie the operator to long term higher energy consumption, and postpone investment in potentially more environmentally beneficial solutions overall. This requires some consideration of the cross-media issues, and guidance on these and the costing and cost-benefits issues is given in the Reference Document on Economics and Cross-Media Effects [179, European Commission, 2006] and in the Reference Document on Best Available Techniques for Energy Efficiency [181, European Commission, 2008]

### **Cross-media effects**

None reported. The systematic analysis of the initial environmental impacts and scope for improvements in the context of the EMS sets the basis for assessing the best solutions for all environmental media.

### **Technical considerations relevant to applicability**

The components described above can typically be applied to all installations within the scope of this document. The scope (e.g. level of detail) and nature of the EMS (e.g. standardised or non-standardised) will be related to the nature, scale and complexity of the installation, and the range of environmental impacts it may have.

### **Economics**

It is difficult to determine accurately the costs and economic benefits of introducing and maintaining a good EMS. There are also economic benefits that are the result of using an EMS and these vary widely from sector to sector.

External costs relating to verification of the system can be estimated from guidance issued by the International Accreditation Forum [186, IAF, 2010].

### **Driving forces for implementation**

The driving forces for the implementation of an EMS include:

- improved environmental performance
- improved insight into the environmental aspects of the company which can be used to fulfil the environmental requirements of customers, regulatory authorities, banks, insurance companies or other stakeholders (e.g. people living or working in the vicinity of the installation)
- improved basis for decision-making
- improved motivation of personnel (e.g. managers can have confidence that environmental impacts are controlled and employees can feel that they are working for an environmentally responsible company)
- additional opportunities for operational cost reduction and product quality improvement
- improved company image
- reduced liability, insurance and non-compliance costs.

### **Example plants**

EMSs are applied in a number of installations throughout the EU.

### **Reference literature**

EMAS Regulation (EC) No 1221/2009. [189, European Union, 2009].

DG Environment EMAS website. [188, DG Environment, 2010]

EN ISO 14001: 2004

ISO 14000 family of standards website. [187, ISO, 2004]

ISO 14000 technical committee. [190, ISO, 2010]

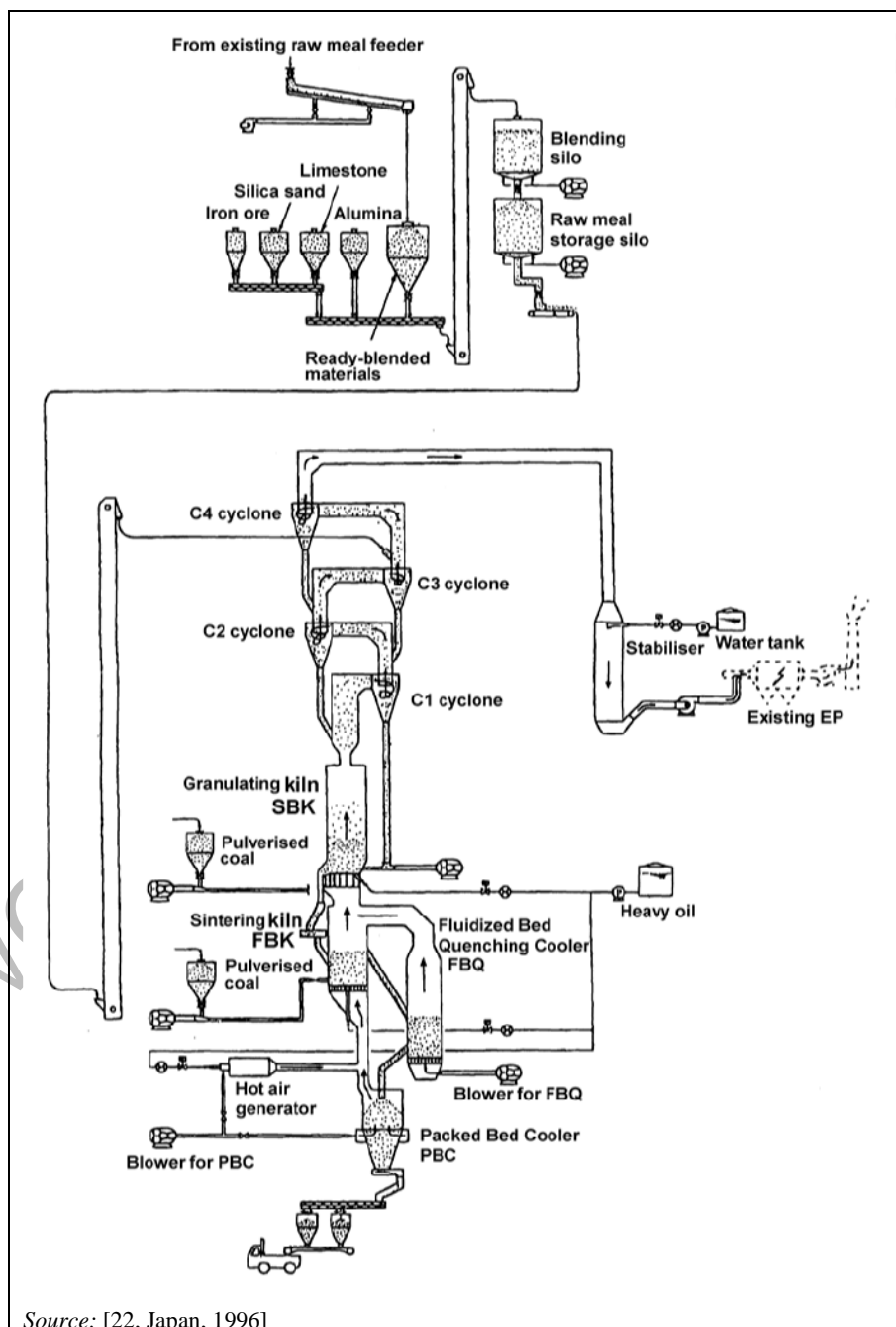
**\*\*NOTE to Article 13 Forum members:** Section 1.5 that included the BAT conclusions have been deleted and replaced by Chapter 4\*\*

## 1.5 Emerging techniques in the cement industry

### 1.5.1 Fluidised bed cement manufacturing technique

The cement sintering technique by means of the fluidised bed cement kiln system has been a project subsidised by the Ministry of International Trade and Industry in Japan since 1986. A pilot plant with the capacity of 20 tonnes clinker/day was operational for six years, between 1989 and 1995, by Sumitomo Osaka Cement Co. Ltd at Toshigi Factory in Japan. A 200 tonnes clinker/day large scale pilot plant was constructed at the end of 1995.

The configuration of the 20 tonnes clinker/day fluidised bed cement kiln system is shown in Figure 1.71. The system consists of a suspension preheater (SP), a spouted bed granulating kiln (SBK), a fluidised bed sintering kiln (FBK), a fluidised bed quenching cooler (FBK) and a packed bed cooler.



Source: [22, Japan, 1996]

Figure 1.71: Fluidised bed cement kiln



The suspension preheater is a conventional four stage cyclone preheater which preheats and calcines the raw meal. The granulating kiln granulates the raw meal into granules of about 1.5 – 2.5 mm diameter at a temperature of 1300 °C. In the sintering kiln, the sintering of the granules is completed at a temperature of 1400 °C. The fluidised bed quenching cooler quickly cools the cement clinker from 1400 to 1000 °C. Finally, the cement clinker is cooled down to about 100 °C in the packed bed cooler.

The cement clinker produced in the fluidised bed kiln is of the same or better quality as the clinker from a commercial plant. The NO<sub>x</sub> emissions are 115 – 190 mg/Nm<sup>3</sup> when heavy oil is used and 440 – 515 mg/Nm<sup>3</sup> when pulverised coal is used as fuel (converted to 10 % O<sub>2</sub>). According to a feasibility study of a 3000 tonne clinker/day plant, the heat use can be reduced by 10 – 12 % compared with a suspension preheater rotary kiln with grate cooler, it is therefore expected that the CO<sub>2</sub> emissions can be reduced by 10 – 12 %.

The final targets of the technical development of the fluidised bed cement kiln system are (in accordance with the feasibility study on a 3000 tonne clinker/day plant and based on the results from the 20 tonnes/day pilot plant):

1. Reduction of heat use by 10 – 12 %
2. Reduction of CO<sub>2</sub> emissions by 10 – 12 %
3. A NO<sub>x</sub> emission level of 380 mg/Nm<sup>3</sup> or less (converted to 10 % O<sub>2</sub>)
4. To maintain the current SO<sub>x</sub> emission level
5. Reduction of construction costs by 30 %
6. Reduction of installation area by 30 %.

### 1.5.2 Staged combustion combined with SNCR

In theory, a combination of staged combustion and SNCR could be comparable to SCR. This combination is considered very promising by suppliers. Some results regarding the use of SCR are described in Section 1.4.5.1.8.

### 1.5.3 Cement kiln flue-gas treatment with dry sodium bicarbonate and chemical re-use

#### Description

This measure/technique is considered for the desulphurisation of the flue-gases from cement kilns, typically in situations where waste materials are used as fuels. To achieve a high abatement rate on SO<sub>2</sub> along with high abatement efficiencies, dry sodium bicarbonate is used and, depending on the characteristics and the composition, sodium-based wastes can often be re-used in the cement production process. However, in some cases these wastes cannot be used because it may lead to a too high sodium content in the cement composition.

In order to allow a high SO<sub>2</sub> abatement with a low quantity of reagent, and, at the same time, to allow the re-use of waste materials from flue-gas treatment, emerging techniques on double step filtration of the flue-gas can be used.

#### *Double step filtration*

A first dust filter collects the process dust which can be re-used in the process as it is not charged with sodium. The dry sodium bicarbonate injection appears downstream of this first filter. Dry ground sodium bicarbonate is injected and reacts with SO<sub>x</sub> to sodium salts, mainly sodium sulphate (Na<sub>2</sub>SO<sub>4</sub>). These wastes from the flue-gas treatment are collected by a second filter, typically a fabric filter.

### **Achieved environmental benefits**

This measure/technique allows high and efficient SO<sub>x</sub> abatements in the flue-gases to be obtained while not compromising the integral re-use of wastes from flue-gas treatment as follows:

- no excessive sodium in cement
- no added SO<sub>x</sub> into the flue-gas.

Furthermore, no waste is produced additionally and additional natural resources are not used.

### **Cross-media effects**

Sodium-based waste could only be re-used to a limited extent. Up until 2008, this was not done because re-use of sodium based waste has impacts on the quality on cement and clinker.

To a certain extent, additional SO<sub>x</sub> emissions may occur which are caused by the recycled calcium or sodium sulphates.

No additional natural resources are used because the reagent CaCl<sub>2</sub> is available in the soda ash plant.

Additional transportation costs may occur because wastes from the flue-gas treatment process have to be transported from the cement plant to the treatment plant. However, the amount of wastes concerned is relatively small in comparison with the total amount of dust and the dust not containing sulphate which is directly re-used in the cement plant.

### **Operational data**

This technique is undergoing tests at the pre-industrial level. In 2008, no operational data were available.

### **Applicability**

Only a few trials have been carried out on wet process using this technique. The double step filtration technique is especially well adapted for plants where ESPs are used for reducing dust emissions. In these cases, the addition of a second filter (fabric filter) may be less expensive than the replacement of the existing one. However, in combination with sodium bicarbonate, there is not any full scale application in the industry.

Regarding double filtration, there is no operational cement plant yet (2008) in combination with sodium bicarbonate, but trials are being carried out.

Regarding the treatment of wastes resulting from flue-gas treatment, this technique is being tested on sulphate-based wastes at pre-industrial scales in France and other specific treatment plants are being studied/planned. This technique is industrially operational and is applied in France and Italy for municipal waste incineration plants treating flue-gas wastes. Information regarding waste incineration can also be found in the Reference Document on Best Available Techniques for Waste Incineration [87, European Commission, 2001].

### **Economics**

Treatment of sodium wastes as such, in order to be used by the chemical industry – as already done in the municipal waste incineration industry – is economically difficult to justify, because of the high dust content available in waste materials used.

### **Driving force for implementation**

High abatement rate or high abatement efficiency requirement for SO<sub>x</sub> in the kiln flue-gas.

### **Example plants and reference literature**

Test plants in France. [168, TWG CLM, 2007], [176, France, 2008], [182, TWG CLM, 2008].

**\*\*NOTE to Article 13 Forum members: Section 1.7 of the CLM BREF has been moved to Chapter 5 – Concluding remarks and recommendations for future work\*\***

WORKING DRAFT IN PROGRESS

---

WORKING DRAFT IN PROGRESS

---

## 2 LIME INDUSTRY

### 2.1 General information about the lime industry

#### 2.1.1 Lime and its application

Lime has been used from almost the ‘beginning of time’, e.g. for 8000 years in the Near East. There is also evidence that the use of quicklime (CaO) and hydrated lime (Ca(OH)<sub>2</sub>) in construction was widespread as early as 1000 B.C. among many civilisations, including the Greeks, Egyptians, Romans, Incas, Mayas, Chinese, and Mogul Indians. The Romans even knew of its chemical properties and used it, for example, for bleaching linen and medicinally as limewater.

In 2008, lime is used in a wide range of products and applications, each suited to particular market requirements. For example, lime and its derivatives are used as a fluxing agent in steel refining, as a binder in building and construction, and in water treatment to precipitate impurities. Lime is also used extensively for the neutralisation of acidic components of industrial effluent and flue-gases.

Lime is applicable and used in many sectors of different industries and agriculture and this product is present in daily life in the form of many applications as shown in Table 2.1.

Application sectors	Application details
Environment – gas	<ul style="list-style-type: none"> <li>used to neutralise flue-gas pollutants such as sulphur and chlorine</li> <li>blended with additives, it captures heavy metals</li> </ul>
Environment – water	<ul style="list-style-type: none"> <li>effluent treatment – treatment of industrial and mining waste water (pH adjustment, removal of phosphorus and nitrogen, and water clarification)</li> <li>potable water softening and removal of impurities from drinking water</li> <li>waste water treatment</li> </ul>
Environment – waste	<ul style="list-style-type: none"> <li>treatment of medical and hazardous waste</li> <li>treatment of organic and inorganic sludges</li> </ul>
Environment – contaminated lands	<ul style="list-style-type: none"> <li>adjustment of pH and immobilisation of sulphates, phosphates and heavy metals</li> </ul>
Construction and civil work	<ul style="list-style-type: none"> <li>used in the production of bricks and structured block</li> <li>masonry and plaster mixes for building facades</li> <li>soil stabilisation and lime road binders</li> </ul>
Agriculture	<ul style="list-style-type: none"> <li>soil treatment – to adjust the pH of soils to give optimum growing conditions and hence improve crop yields</li> </ul>
Steel and non-ferrous metals	<ul style="list-style-type: none"> <li>used in steelmaking processes in order to reduce sulphur and phosphorus, to modify slag viscosity, to protect refractories and to form the slag</li> <li>used as a flux in the smelting of copper, lead, zinc and other metals from their ores</li> <li>used to neutralise and coat wire after it is cleaned with acid</li> </ul>
Chemical and paper industry	<ul style="list-style-type: none"> <li>paper – manufacturing process; pulp and raw material for precipitated calcium carbonate (PCC)</li> <li>oil additive for lubricants (such as sulphonates, phenates and salicylates)</li> <li>plastics – used as a desiccant in the manufacture of petrochemical based products</li> <li>used in leather tanning</li> <li>used in the glass and soda industries</li> <li>acid neutralisation</li> </ul>
Pharmaceutical, personal care and food	<ul style="list-style-type: none"> <li>use in the matrix composition of drugs</li> <li>used in the manufacture of calcium phosphate, a toothpaste additive</li> <li>used in the manufacture of food and drink additives</li> <li>used in the sugar industry to precipitate out impurities from beet and cane extracts and also to neutralise odours generated by beet washing and transport</li> </ul>

Source: [44, EuLA, 2006]

**Table 2.1: Lime, a versatile material – some industrial applications**

## 2.1.2 World lime production

In 2006, the total world lime production was estimated to be 172 Mt/yr, including captive lime, as shown in Table 2.2.

Country	Annual production	
	Mt/yr	%
Brazil	6	3.5
China	75	43.6
EU-25	28	16.3
Other European countries	2	1.2
India	4	2.3
Japan	10	5.8
Mexico	4	2.3
Russia	8	4.7
US	20	11.6
Other countries	15	8.7
Total	172	100

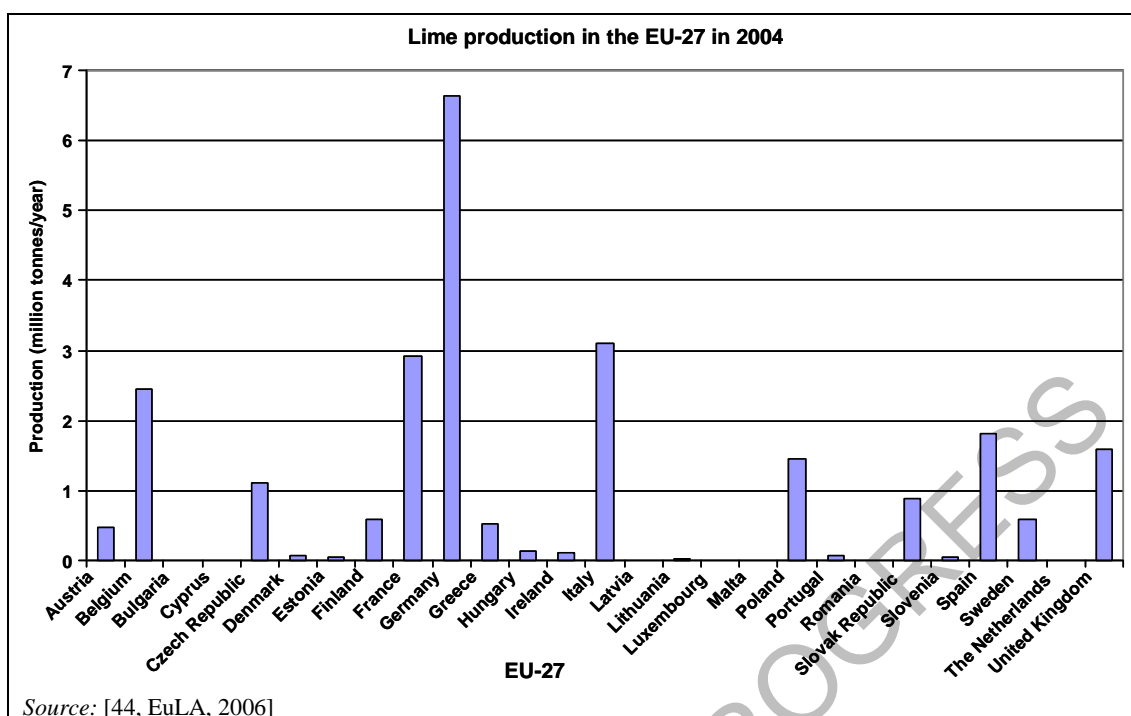
*Source:* [44, EuLA, 2006], [168, TWG CLM, 2007]

**Table 2.2:** Best estimate of world quicklime and dolomite production in 2006 in the EU-27, including captive lime production

## 2.1.3 Geographical distribution and general economic considerations in Europe – principal indicators

### 2.1.3.1 Annual production

Germany, France, Poland, Belgium, Spain and Italy are the largest producers of lime in the EU-27, which account for about 20 % of the total world lime production. In four EU Member States, no lime is produced, and these are Cyprus, Malta, Luxembourg and the Netherlands. The structure of the lime industry varies from one Member State to another. However, in most EU countries the lime industry is characterised by small and medium sized companies. Thus, there are more than 100 companies operating in the European Union. Most of them are small producers often with one single plant. However, there has been a growing trend towards concentrations in recent years, with a small number of large international companies having gained a considerable market share. Figure 2.1 illustrates the European production market in the EU-27, as it was in 2004 which represented almost 25 million tonnes of lime for a total European production of 28 million tonnes including commercial and captive lime production.



**Figure 2.1: Lime and dolomite production in the EU-27 in 2004**

The production of lime in the EU countries dropped at the end of the 1980s, only to increase again at the beginning of 1994. This was as a consequence of changes in patterns of consumption. One of the main users of lime, the iron and steel industry, reduced its specific lime consumption per tonne of steel from 100 to 40 kg. However, around the middle of the 1990s the growing use of lime for environmental protection brought sales figures back up again.

In the past, total lime consumption in the EU stagnated because sectors with increasing demand, such as water treatment and flue-gas desulphurisation, only partially compensated for the decreased demand in the traditional steel and metallurgy sectors.

Lime is a low cost but bulky material, so it tends to be transported only over relatively short distances. Exports of lime from the EU only amount to a few per cent of the production. The 2004 estimated market shares of commercial lime in the EU-27 countries by different sectors are shown in Table 2.3.

Sectors	Contribution (%)
Steel making and non-ferrous metals processing	30 – 40
Environmental protection, agriculture and forestry	30
Construction and clay soil stabilisation	15 – 20
Others: chemicals, non-ferrous metal refining, PCC for paper, food, feed and healthcare	10 – 15

Source: [44, EuLA, 2006]

**Table 2.3: Distribution of commercial lime by sectors in the EU-27 in 2004**

### 2.1.3.2 Key environmental and sustainable development issues

The key environmental issues for the production of lime are the energy consumption, CO<sub>2</sub> emissions from the process and combustion, air pollution control (essentially dust), transport and extraction site restoration [44, EuLA, 2006].

The key sustainable development issues for the extraction of the main raw materials for lime production reside in the access to high quality limestone and dolomite deposits to secure geological reserves for a long term future. Geologically, limestone is a common stone. However, it is rare to find deposits with all of the following essential characteristics:

- reserve for 50 years or more
- high chemical purity
- specific physical and mechanical properties
- proximity to transport infrastructures
- environmental constraints.

Table 2.4 shows the predicted use of limestone for 2030 as compared to the year 2003.

<b>Raw material limestone and dolomite use trend 2003 – 2030</b>		
Lime applications: construction materials and industrial uses (steel, paper, glass, sugar, soil protection, environment protection)	2003 million tonnes per year	2030 million tonnes per year
Lime/dolomite production after calcination of limestone and dolomite	25	32
Raw materials for producing lime and dolomite	50	64
<i>Source: [44, EuLA, 2006]</i>		

**Table 2.4: Trend of raw material limestone and dolomite use in the period 2003 – 2030**

### 2.1.3.3 Type of lime and dolomitic lime

Often the term ‘lime’ is used incorrectly to describe limestone products. This is a frequent cause of confusion. Lime includes quicklime and slaked lime and this term ‘lime’ is synonymous with the term ‘lime products’. Quicklime, or so-called ‘burned lime’, is calcium oxide (CaO) produced by decarbonisation of limestone (CaCO<sub>3</sub>). Slaked lime is produced by reacting or ‘slaking’ quicklime with water and consists mainly of calcium hydroxide (Ca(OH)<sub>2</sub>). Slaked lime includes hydrated lime (dry calcium hydroxide powder), milk of lime and lime putty (dispersions of calcium hydroxide particles in water). However, 90 % of the total amount produced is lime and 10 % dolime.

These different types of lime are used for a wide variety of applications. A distinction is made between calcium limes, dolomitic limes and hydraulic limes. Calcium limes are by far the largest category and are supplied in lump, ground and hydrated forms. Dolomitic limes are more specialised products and are supplied in smaller quantities in lump, ground, hydrated and dead burned forms.

Hydraulic limes are partially hydrated and contain cementitious compounds, and are used exclusively in building and construction.

In this document, only non-captive lime production will be discussed.

Table 2.5 shows the different synonyms used in the lime field with their corresponding CAS (a division of the American Chemical Society) Registry numbers and their EC numbers found in the EINICS Inventory (European Inventory of Existing Commercial Chemical Substances).



Chemical compound	Chemical formula	Synonyms	EC #	CAS #
Calcium oxide	CaO	Lime, burned lime and quicklime	215 – 138-9	1305 – 78-8
Calcium magnesium oxide	CaO MgO	Dolomitic lime, dolime	253 – 425-0	37247 – 91 – 9
Calcium hydroxide	Ca(OH) <sub>2</sub>	Calcium hydrate, calcium hydroxide, caustic lime, hydrated lime and slaked lime	215 – 137-3	1305 – 62-0
Calcium magnesium tetrahydroxide	CaMg(OH) <sub>4</sub>	Dolomitic hydrated lime, calcium magnesium hydroxide	254 – 454-1	39445 – 23-3

Source: [44, EuLA, 2006]

**Table 2.5: Lime nomenclatures, EC and CAS numbers**

#### 2.1.3.4 Lime Installations

There were approximately 211 lime-producing installations in the European Union (excluding captive lime production) in 2003, which were distributed across the EU Member States as shown in Table 2.6.

Country		Production of lime & dolime	Production of dead burned dolime
Belgium	BE	6	1
Bulgaria	BG	6	1
Czech Republic	CZ	5	0
Denmark	DK	1	0
Germany	DE	39	1
Estonia	EE	1	0
Greece	EL	19	0
Spain	ES	22	2
France	FR	16	0
Ireland	IE	1	0
Italy	IT	36	1
Cyprus	CY	0	0
Latvia	LV	1	0
Lithuania	LT	1	0
Luxembourg	LU	0	0
Hungary	HU	3	0
Malta	MT	0	0
Netherlands	NL	0	0
Austria	AT	6	0
Poland	PL	8	0
Portugal	PT	4	0
Romania	RO	8	0
Slovenia	SI	3	0
Slovakia	SK	6	0
Finland	FI	6	0
Sweden	SE	7	0
United Kingdom	UK	6	2
<b>TOTAL</b>		<b>211</b>	<b>8</b>

Source: [44, EuLA, 2006], [139, Italy, 2007]

**Table 2.6: Number of non-captive lime plants in the EU-27 Member States with production exceeding 50 t/d - total from 2003**

In 2006, there were a total of about 597 kilns producing commercial lime (excluding captive lime kilns) in the EU-27 which can be grouped into six different types of kilns. Table 2.7 and Figure 2.2, Figure 2.3 and Figure 2.4 show the number of operated kilns per type of kiln and their relative importance in the production of lime, dolime and sintered dolime (dead burned lime) in the EU-27.

Type of kiln	Number of kilns
Long rotary kiln (LRK)	26
Rotary kiln with preheater (PRK)	20
Parallel flow regenerative kiln (PFRK) (standard and fine lime)	158
Annular shaft kiln (ASK)	74
Mixed-feed shaft kiln (MFSK)	116
Other kilns (OK)	203
<b>TOTAL</b>	<b>597</b>

*Source: [44, EuLA, 2006] [46, Germany, 2006]*

Table 2.7: Number of operational lime kilns per type of kiln in 2004 in the EU-27

Other kilns (OK) can be:

- double-inclined shaft kilns
- multi-chamber shaft kilns
- central burner shaft kilns
- external chamber shaft kilns
- beam burner shaft kilns
- internal arch shaft kilns
- travelling grate kilns
- ‘topshaped’ kilns
- flash calciner kilns
- rotating hearth kilns.

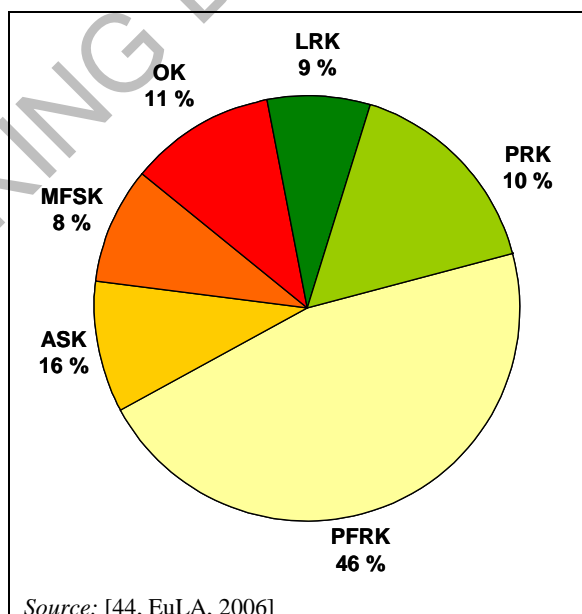


Figure 2.2: Production of commercial lime per type of kiln in the EU-27 in 2004

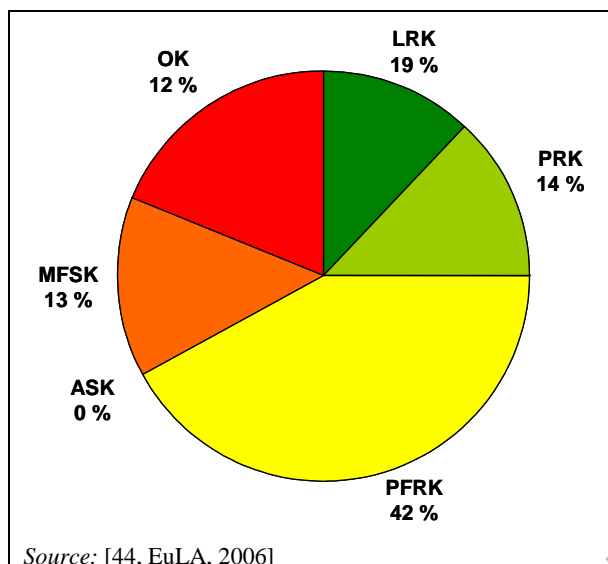


Figure 2.3: Production of commercial dolime per type of kiln in the EU-27 in 2004

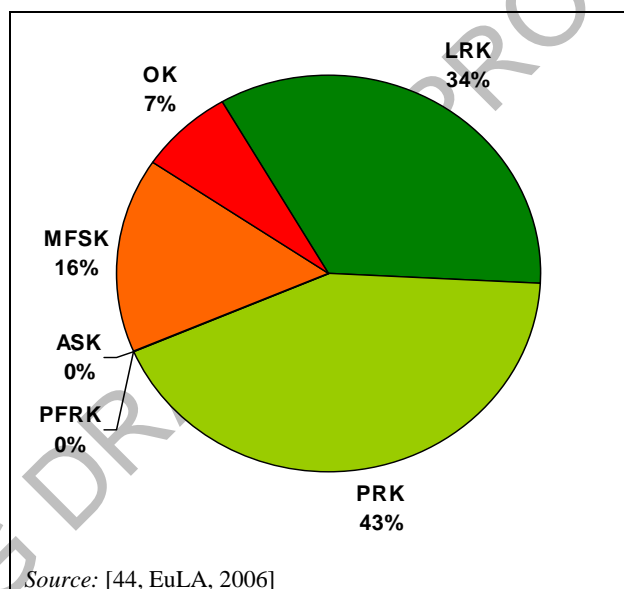


Figure 2.4: Production of commercial sintered dolime per type of kiln in the EU-27 in 2004

For manufacturing lime, dolime or sintered dolime, typical capacities of lime kilns are between 50 and 500 tonnes per day. Only about 10 % of these lime kilns have a capacity of less than 10 or more than 500 tonnes per day. Table 2.8 gives an overview of the numbers of different types of kilns per country in the EU-27 in 2003 for the production of lime and dolime.

Country		Long rotary kiln (LRK)	Rotary kiln with preheater (PRK)	Parallel flow regenerative kiln (PFRK)	Annular shaft kiln (ASK)	Mixed-feed shaft kiln (MFSK)	Other kilns (OK)	Total
Belgium	BE	5	3	14	5	9	1	37
Bulgaria	BG	1	-	2	-	-	29	32
Czech Republic	CZ	-	2	8	-	4	2	16
Denmark	DK	1	-	-	-	-	-	1
Germany	DE	1	6	15	32	64	17	135
Estonia	EE	-	-	-	-	-	2	2
Greece	EL	2	-	2	2	-	40	46
Spain	ES	3	1	34	1	1	9	49
France	FR	-	2	18	23	-	5	48
Ireland	IE	-	-	1	-	-	-	1
Italy	IT	-	-	31	4	-	35	70
Cyprus	CY	-	-	-	-	-	-	0
Latvia	LV	-	-	-	-	-	1	1
Lithuania	LT	1	-	-	-	-	-	1
Luxembourg	LU	-	-	-	-	-	-	0
Hungary	HU	-	-	3	-	-	-	3
Malta	MT	-	-	-	-	-	-	0
Netherlands	NL	-	-	-	-	-	-	0
Austria	AT	-	-	3	3	1	3	10
Poland	PL	-	-	4	-	36	1	41
Portugal	PT	-	-	3	-	-	6	9
Romania	RO	-	-	7	-	-	14	21
Slovenia	SI	-	-	-	2	-	10	12
Slovakia	SK	-	4	3	-	1	13	21
Finland	FI	5	-	3	1	-	-	9
Sweden	SE	5	-	4	-	-	-	9
United Kingdom	UK	5	2	8	-	-	6	21
Total		29	20	163	73	116	194	595

Source: [44, EuLA, 2006], [139, Italy, 2007]

**Table 2.8: Number of lime kilns per country in the EU-27 in 2003 for the production of lime and dolime, not including captive kilns**

The lime industry is a highly energy intensive industry with energy accounting for 30 – 60 % of total production costs. Kilns are fired with fossil fuels, such as solid, liquid or gaseous fuels as well as waste fuels and/or biomass. The use of waste as fuels depends on the expected lime quality. The use of waste can have an effect on lime quality and the characteristics of wastes have to be investigated before being used. The use of fossil fuels has decreased and the use of waste fuels has grown over the last few years. Table 2.9 shows the distribution of the fuel types used in the EU-27 in 2003.

Type of fuel	Unit	EU-27 2003
Gas (fossil)	%	43
Solid (fossil)	%	41
Liquid (fossil)	%	7
Others	%	-
Waste	%	8
Biomass	%	1

Source: [16, EuLA, 2001], [44, EuLA, 2006]

**Table 2.9: Distribution of fuels used in lime burning in the EU-27 in 2003**

The main emissions from lime production are atmospheric emissions from the kiln. These result from the particular chemical composition of the raw materials and fuels used. However, significant dust emissions can occur from any part of the process, notably the hydrator and the kiln. Furthermore, diffuse dust emissions can occur, e.g. from conveyors, from transport and from bulk storage. Potentially significant emissions from lime plants include carbon oxides (CO, CO<sub>2</sub>), nitrogen oxides (NO<sub>x</sub>), sulphur dioxide (SO<sub>2</sub>) and dust.

WORKING DRAFT IN PROGRESS

## 2.2 Applied processes and techniques in lime manufacturing

The process for lime manufacturing consists of the burning of calcium and/or magnesium carbonates at a temperature of between 900 and 1200 °C, which is sufficiently high to liberate carbon dioxide, and to obtain the derived oxide ( $\text{CaCO}_3 \rightarrow \text{CaO} + \text{CO}_2$ ). For some processes, significantly higher burning temperatures of up to 1800 °C are necessary, for example dead burned dolomite.

The calcium oxide product from the kiln is generally crushed, milled and/or screened before being conveyed to silo storage. From the silo, the burned lime is either delivered to the end user for use in the form of quicklime, or transferred to a hydrating plant where it is reacted with water to produce hydrated or slaked lime.

Figure 2.5, Figure 2.6 and Figure 2.7 show the basic steps involved in the overall lime manufacturing process listed as follows [44, EuLA, 2006]:

- quarrying/winning of raw material from limestone properties
- limestone storage and preparation
- storage and preparation of different types of fuels
- calcination of limestone
- quicklime hydration and slaking
- quicklime processing
- other processing of lime
- storage, handling and transport.

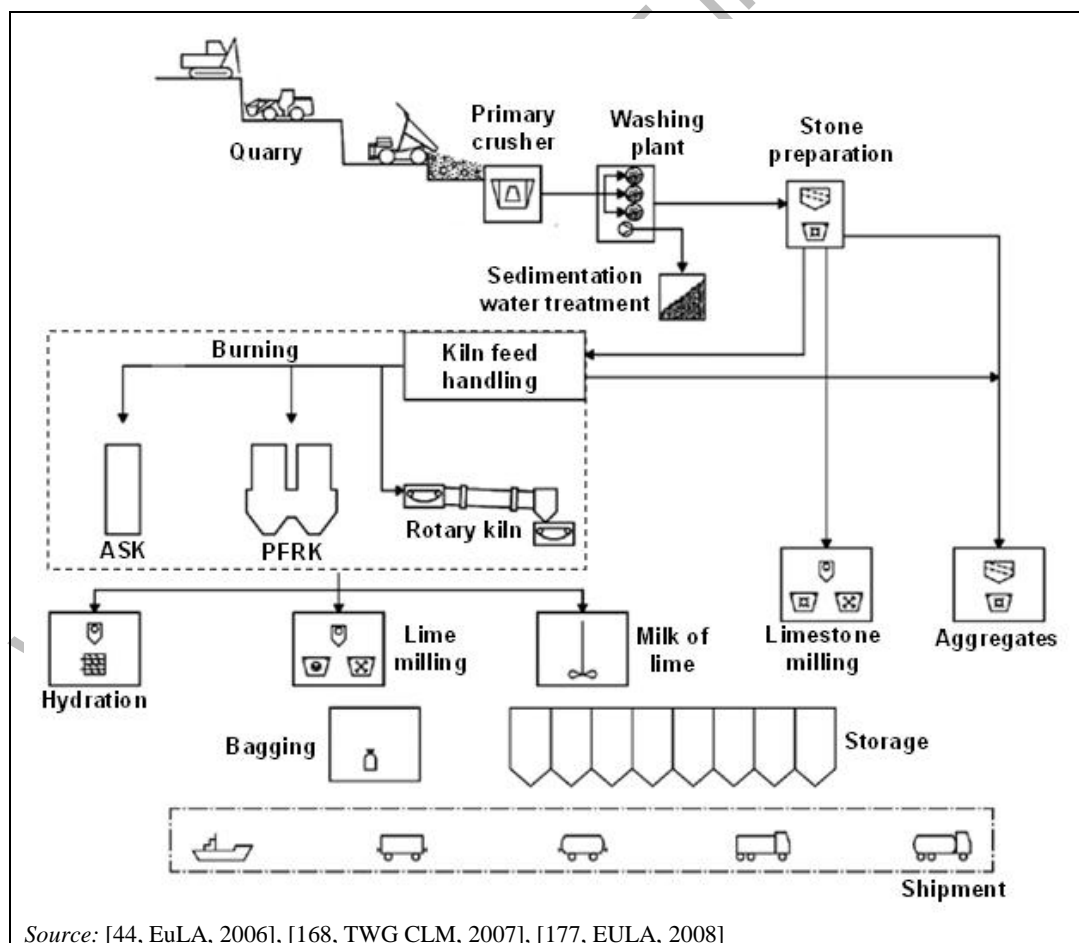


Figure 2.5: Overview of the lime manufacturing process

### 2.2.1 General production process description

The manufacture of lime depends first on the quality of the limestone which is inherent of the geological situation of the deposit. The limestone is processed and charged into a kiln where it undergoes a thermal decomposition reaction with the resultant production of calcium oxide and carbon dioxide. This 'product', commonly called burned lime or quicklime, is processed in size and is then stored, transported or further processed. Figure 2.6 shows a flow diagram of the cornerstones for lime production.

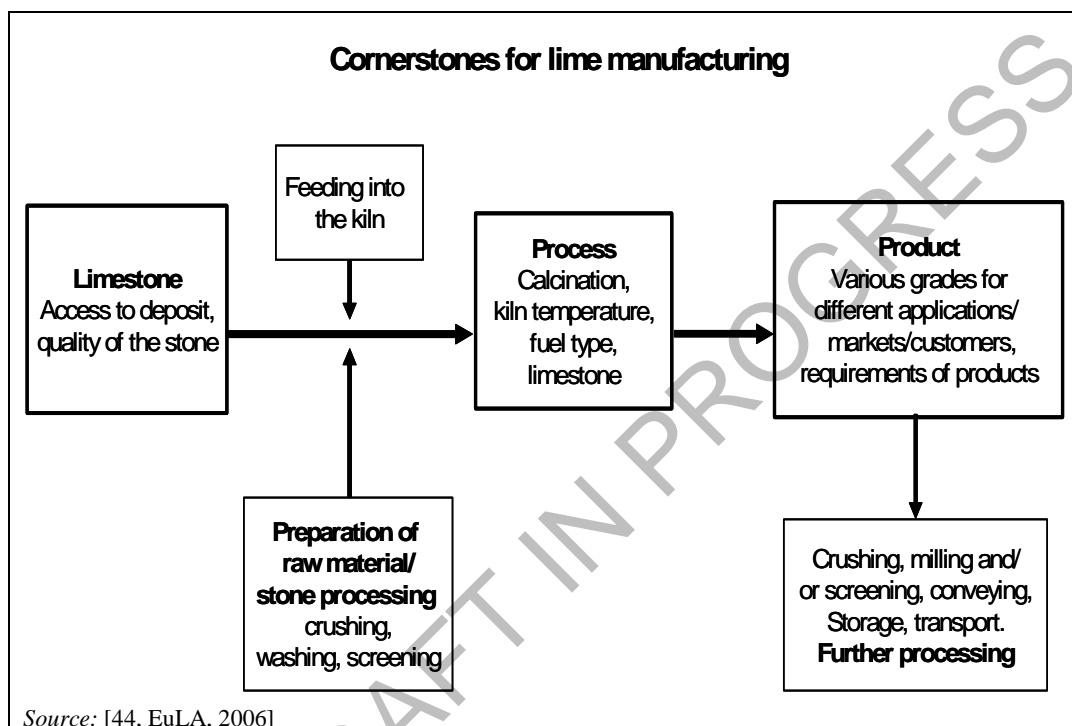
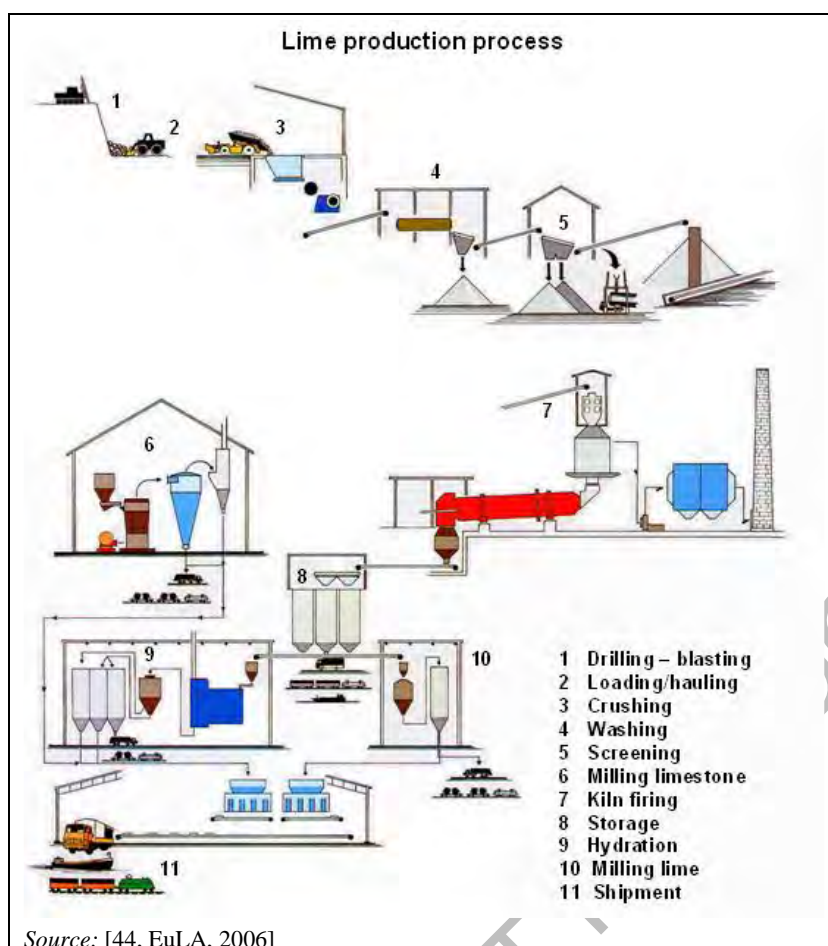


Figure 2.6: Flow diagram of the cornerstones for lime manufacturing

The three big cornerstones 'limestone', 'process' and 'product' form the basis of a 'matrix' being dependent on each other for producing a product necessary for the different market demands. Lime is used for the production of various products which can be used by a wide range of industrial sectors and it is an indispensable interim product for many processes. The various ranges of application, however, also require various physico-chemical properties of the lime products. The requirements of lime qualities are laid down, in particular, in National as well as European Standards, but also in direct agreements between manufacturers and customers. The lime industry has always been prepared to comply with the wide range of quality requirements with a mature technique, i.e. special kiln types including their respective fuels.

The quality of the limestone,  $\text{CaCO}_3$  and dolomite  $\text{CaMg}(\text{CO}_3)_2$  respectively play a particular role in the production process, on the final quality of the lime and on the chemical composition. The kiln technique, i.e. kiln type and fuel used, considerably influences the properties of the lime produced. Therefore, various kiln types for the achievement of various lime qualities were developed worldwide. On the basis of the available limestone deposits together with the requirement profile of the customer, the optimal kiln/fuel combination was chosen in order to develop the best available techniques for the lime manufacturing process.

The process for manufacturing lime is shown in Figure 2.5 and Figure 2.7.



**Figure 2.7: Overview of a lime manufacturing process**

## 2.2.2 Raw materials and winning of limestone

The raw material for lime production is limestone or, to a lesser extent, dolomite or dolomitic limestone. Ten per cent of the total's world volume of sedimentary rock is limestone.

Typically, limestone contains more than 90 %  $\text{CaCO}_3$  and a few per cent  $\text{MgCO}_3$ . Dolomite is a double carbonate containing 54 – 58 %  $\text{CaCO}_3$  and 40 – 44 %  $\text{MgCO}_3$ . Dolomitic limestone usually refers to a limestone containing  $\text{MgCO}_3$  at a higher level than limestone but less than dolomite. The raw material, such as limestone, can be more than 360 million years old. While limestone deposits are relatively abundant in many countries, only a small proportion is suitable for commercial extraction.

Limestone rock is formed first from the combined dissolution process of calcium ions and carbon dioxide which follows either an organic route with the action of a variety of organisms or an inorganic route involving the crystallisation of carbonate. This process is then followed by a process called diagenesis or conversion of sediments into rocks. This process is quite complex involving several organic, physico-chemical routes. It is, therefore, conceivable to find that limestone exists in many forms depending on how it was originally formed. This is then reflected on its grain size, microstructure, texture, impurities, and carbonate content.

The level of impurities or trace elements and the carbonate content are particularly important for the suitability of the limestone for many applications. Table 2.10 shows the typical range of common impurities or trace elements generally found in limestone. An example of raw material composition from used limestone in a Hungarian lime plant is shown in Section 6.3.2.1 in Table 6.29.



Impurities or metals	Units	Typical range
Silica (as SiO <sub>2</sub> )	%	0.1 – 2.0
Alumina (as Al <sub>2</sub> O <sub>3</sub> )	%	0.04 – 1.5
Iron (as Fe <sub>2</sub> O <sub>3</sub> )	%	0.02 – 0.6
Sulphur (S)	%	0.0024 – 0.118
Carbonaceous matter	%	0.01 – 0.5
Manganese (as MnO <sub>2</sub> )	mg/kg	20 – 1000
Antimony	mg/kg	0.1 – 3
Arsenic	mg/kg	0.1 – 15
Boron	mg/kg	1 – 20
Cadmium	mg/kg	0.1 – 1.5
Chromium	mg/kg	3 – 15
Copper	mg/kg	1 – 30
Lead	mg/kg	0.5 – 30
Mercury	mg/kg	0.02 – 0.1
Molybdenum	mg/kg	0.1 – 4
Nickel	mg/kg	0.5 – 15
Selenium	mg/kg	0.02 – 3
Silver	mg/kg	0.2 – 4
Tin	mg/kg	0.1 – 15
Vanadium	mg/kg	1 – 20
Zinc	mg/kg	3 – 500
<i>Source:</i> [44, EuLA, 2006], [70, Hungary, 2006], [126, Oates, 1998]		

**Table 2.10:** Typical impurities and trace elements in limestone

However, for the production of natural hydraulic lime the raw materials used contain 65 – 90 % CaCO<sub>3</sub> and MgCO<sub>3</sub>. The purity of this raw material is different from raw materials which are used for the production of other types of lime. Furthermore, the organic content, expressed in terms of TOC, is much higher and is in the range of between 0.8 and 5 % [127, Portugal, 2007].

The raw material, such as high purity limestone or dolomite, is quarried, precrushed and, in some cases, washed and then screened before being transported to the lime plant. Limestone is normally obtained by surface quarrying, generally adjacent to the lime plant and the raw material can be transported directly by using belt conveyors to the plant, but in some cases sea dredging or even underground mining are used. The supply of raw material from quarries far away from the plant is also possible, e.g. by using vessels. A typical mining process includes:

- removal of the overburden (i.e. the soil, clay and loose rock positioned on the deposit)
- blasting of rock
- loading and transportation of the blasted rock to the crushing and screening plant.

Useful information regarding mining/quarrying can be found in the Reference Document on Best Available Techniques for Management of Tailings and Waste-Rock in Mining Activities [47, European Commission, 2004].

## 2.2.3 Limestone preparation, cleaning and storage

### 2.2.3.1 Limestone preparation

The manufacture of lime depends first on the quality of the limestone which is inherent of the geological situation of the deposit. Selective mining can improve the quality of limestone for the calcinations process. If the impurities or trace elements are present heterogeneously, some of them can generally be removed by selective quarrying, washing or screening. However, if present homogeneously in limestone, these processes are ineffective. The properties of the

limestone such as its porosity, hygroscopic behaviour or water absorption, bulk density, hardness, strength and decrepitating properties are interdependent. They are found to play a crucial role in the calcination or burning process and the chemical and physical properties of the resultant end-product.

It is typical for the limestone to be drilled and blasted on manageable benches. The blasted limestone is then fed to the crushing and screening processes.

Limestone rocks with sizes of one metre in diameter are often crushed in primary crushers to an appropriate size range of 100 – 250 mm. Depending on the nature of the rock (hardness, lamination, size, etc.) various types of primary crushers are used, such as: jaw crushers, gyratory crushers and impact crushers. Sometimes crushing plants are located at the quarry and are mobile.

Crushed limestone from the primary crusher is transported via conveyors to vibrating screens, where large pieces are separated and recycled while those passing through are used as kiln charge, or may be fed into the secondary crushers located further down the process line.

Secondary crushers are used for crushing the limestone to a size range of 5 – 80 mm. As the kiln charge does not have to be very fine, jaw and impact crushers are also often used as secondary crushers, as are hammer mills.

After crushing, the limestone is screened in a screening unit and then transported to limestone storage silos, stockpiles or bunkers for storage prior to feeding into the lime kilns by using belt conveyors and/or bucket elevators.

The particle size distribution of the crushed and screened limestone must be compatible with the requirements of the kiln. This generally requires the limestone to be screened to a stone size ratio of, ideally 2:1, or at least 3:1.

### **2.2.3.2 Limestone storage**

Screened sizes of limestone are stored in bunkers and in outdoor stockpiles. Fine grades are usually stored in silos and stockpiles.

### **2.2.3.3 Limestone washing**

Before feeding into the kiln, the limestone is sometimes washed, e.g. in washing drums or on screens. Fewer than 10 % of the lime plants wash the limestone in order to reduce the amount of natural sand and clay, which may have a negative effect on the kiln process, or affect the quality of the final products.

This washing aids the burning process by leaving free space between the stones for combustion air circulation, thus reducing the amount of excess air and saving electrical energy. Techniques for piling the limestone, for better washing, have been developed.

Suspended solids are removed from the washing water by:

- settling pits which may later be left for recultivation
- dehydration in filter presses.

The purified water from both systems is re-used in the washing process as shown in Figure 2.8.

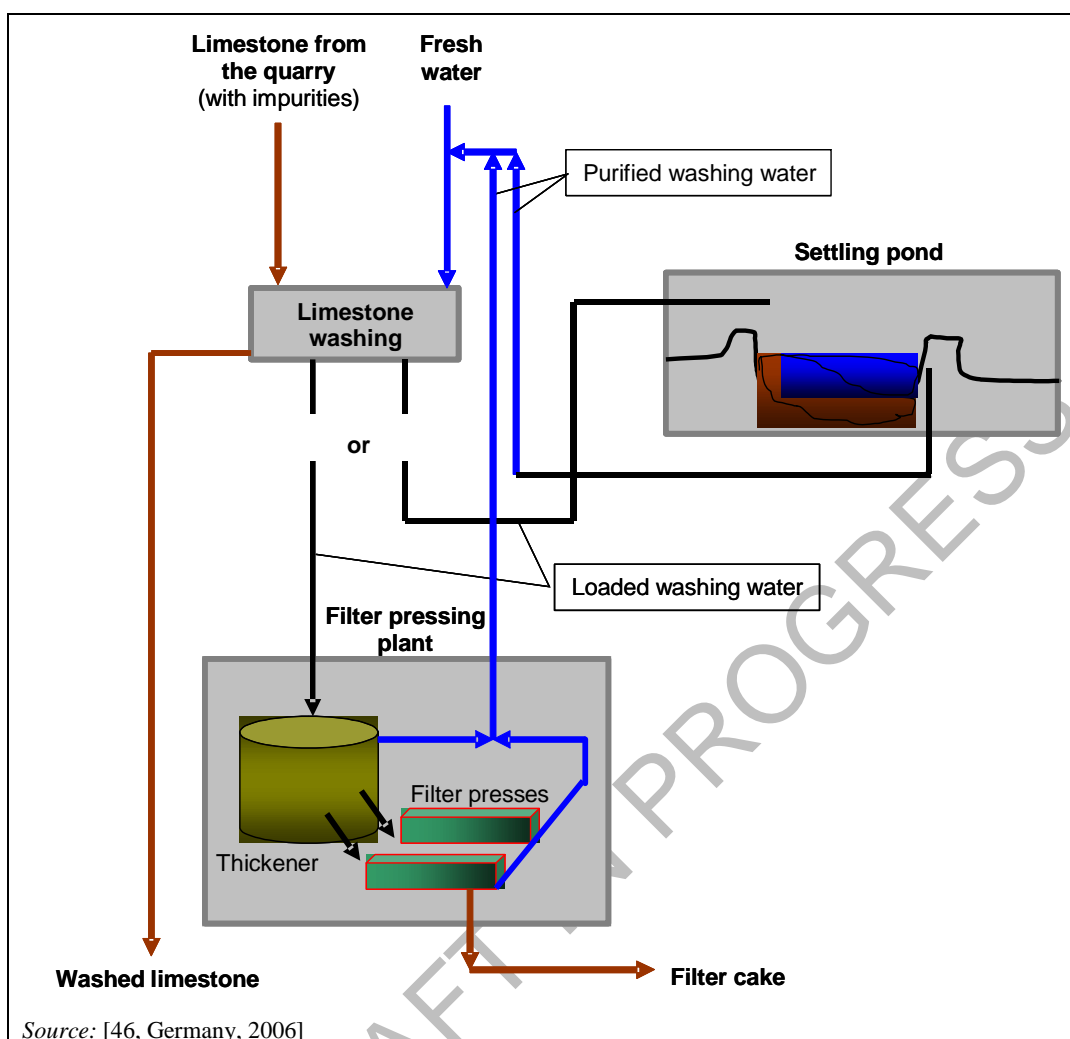


Figure 2.8: Material flow diagram for limestone washing and washing water purification

## 2.2.4 Fuels – preparation and storage

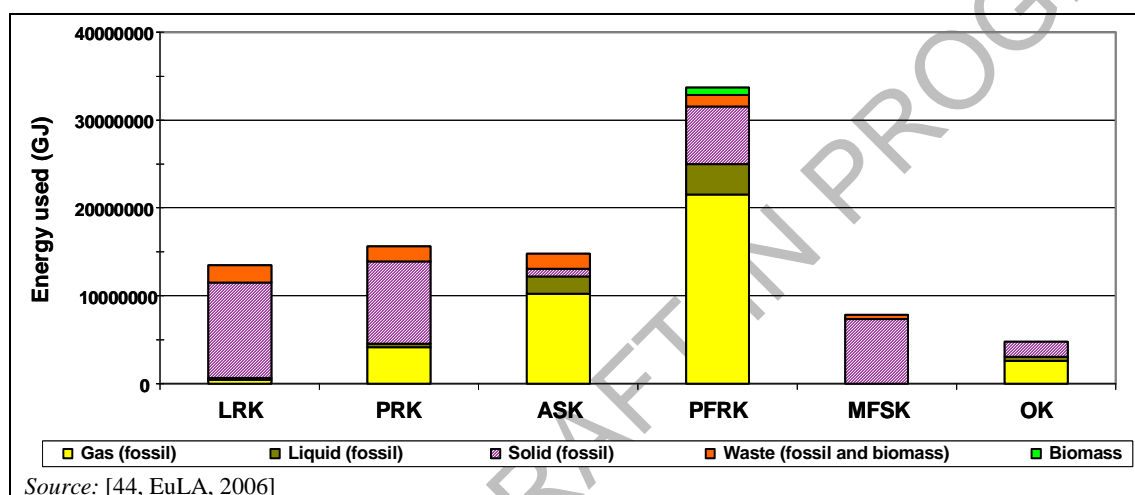
The lime industry is a highly energy intensive industry with energy accounting for up to 60 % of total production costs. In lime burning, the fuel provides the necessary energy for calcining. It also interacts with the process, and the combustion products react with the quicklime. Many different fuels are used in lime kilns. The most common in the EU are natural gaseous fuels, such as natural gas, coke oven gas, solid fuels such as coal (hard coal, pulverised lignite and petcoke), coke/anthracite as well as liquid fuels such as heavy and/or light fuel oil. Waste is also used as fuel, e.g. used oil, plastics, paper, and animal meal (meat bone meal) or sawdust [44, EuLA, 2006], [45, Schorcht, 2006], [46, Germany, 2006].

Most kilns can operate on more than one fuel, but some fuels cannot be used in certain kilns. Some fuels require a special refractory kiln lining. Table 2.11 shows the percentage of types of fuels used in different lime kilns in 2003 and Figure 2.9 shows the types of fuels and the energy used in 2005 in the EU-27.

Type of fuel	Fuel description	Percentage of fuels used in different types of lime kilns (%)					
		LRK	PRK	ASK	PFRK	MFSK	OK
Gas (fossil)	Natural gas, coke oven and converter gas, butane/propane gas	3	26	69	64	0	51
Solid (fossil)	Coal, petcoke, metallurgical coke, lignite, anthracite	81	60	6	20	100	32
Liquid (fossil)	Heavy, medium and light fuel oil	1	3	14	10	0	10
Waste (fossil and biomass)	Waste wood, tyres, plastics, waste liquid fuels, animal fat, meat bone meal	14	11	11	3	0	7
Biomass	Wood, woodchips, sawdust, wastes from agriculture and forestry	0	0	0	3	0	0

Source: [44, EuLA, 2006], [46, Germany, 2006], [64, Czech Republic, 2006]

**Table 2.11:** Types of fuels used in different lime kilns in 2003 in the EU-27



Source: [44, EuLA, 2006]

**Figure 2.9:** Types of fuels used for the lime kiln firing process in 2005 in the EU-27

The choice of fuel(s) for a lime-burning operation is very important for the following reasons:

- cost of fuels – the cost of fuel per tonne of lime can represent 30 to 60 % of the production cost
- availability of fuel on the market
- quality of the lime – the effect of fuel on lime quality influences the residual CO<sub>2</sub> level, impurities, whiteness, and the reactivity and the sulphur content, etc.
- emissions – fuel affects the emission levels of carbon dioxide, carbon monoxide, smoke, dust, sulphur dioxide and nitrogen oxides, all of which have an environmental impact
- saving of primary energy – fuel oil and natural gas.

A comparison of different fuels with regard to specific costs and sulphur content can be found in Figure 3.13 of the DBM chapter of this document (see Section 3.4.5).

The fuels are prepared, as required for the injection system (heated, pulverised), which can be of the direct or indirect firing type. In the case of solid fuels, this involves delivery at the appropriate particle size for the installed handling system. In the case of liquid and gaseous fuels, the required pressure and (as appropriate) temperature need to be maintained.

Often coal is milled by a coal mill and stored in a silo. Safety problems, such as risks regarding explosions of the coal dust have to be considered, e.g. the use of pressure shock proof silos of up to 10 bar pressure and the use of inert gas. Lignite, coal and sawdust must be stored in such a way that self-ignition of the fuel is avoided.

An example of a dosing system principle for a shaft kiln is shown in Figure 2.10 and Figure 2.11.

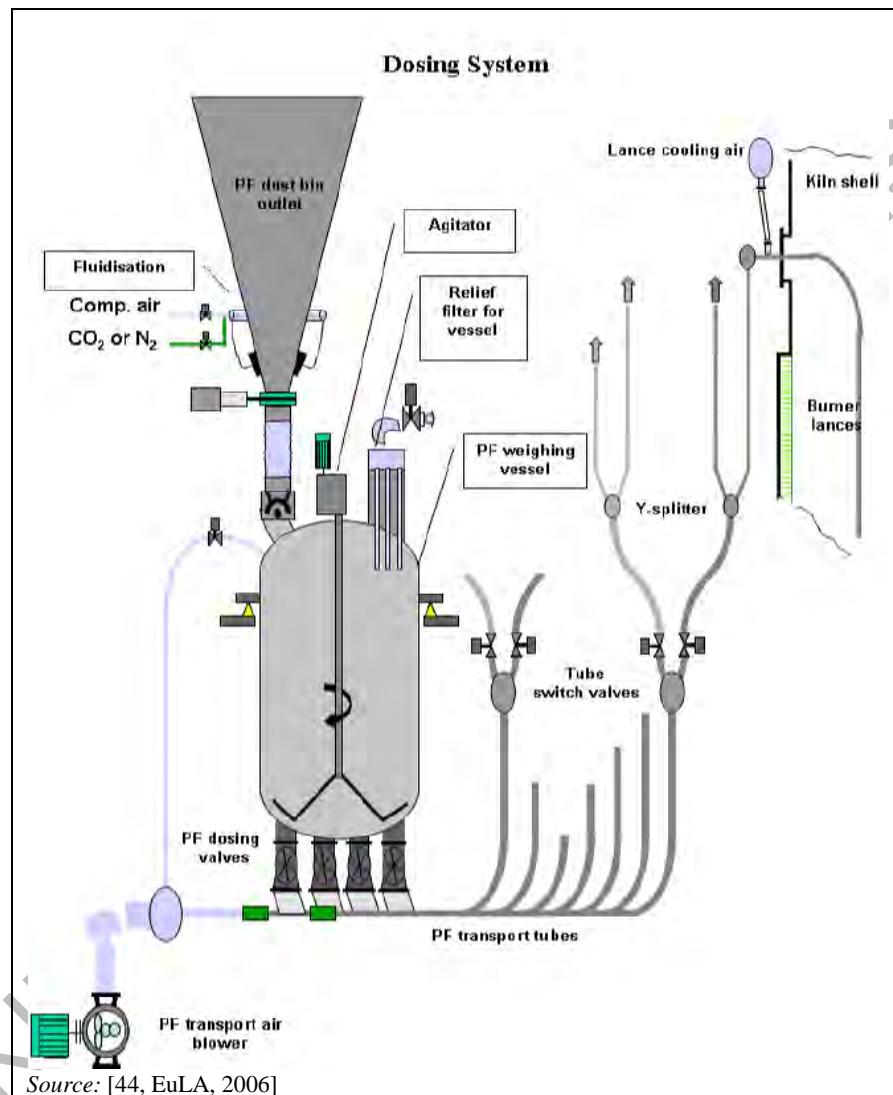


Figure 2.10: Flow diagram of a shaft kiln dosing system example



Source: [44, EuLA, 2006]

**Figure 2.11:** Example of a shaft kiln dosing system

## 2.2.5 Use of waste

### 2.2.5.1 General aspects

Lime manufacturing requires a substantial input of energy, thus making fuel the largest production cost. The use of waste fuels enables the lime producer to reduce the consumption of fossil fuels such as gas and liquid fuels and contributes to the economic viability of the lime sector in Europe. Since 1997, the European lime industry has been using more waste fuels as well as biomass. However, the quality of these waste fuels is important for using in lime manufacturing. Furthermore, the use of waste has an effect on the lime quality, such as the limitation of the usage of the lime. In any case, the use of waste fuels is also cost effective in relation to transport costs and unit prices of these fuels.

The EU Member States subject the use of waste fuels to rather different legal requirements. Requirements are imposed on the characteristics of wastes and on a number of substances which are contained in waste materials. In France, Germany and the UK, specifications and thresholds are listed, which may vary from region to region. In addition for metals, different thresholds with different totals are defined by the national or regional authorities.

Like any fuel switch and due to the specific product requirements and the nature of the production processes, the specific physical properties of the waste fuels have to be considered and need to be very precisely defined (e.g. physical state, net calorific value, chemical composition). High calorific waste, such as some pretreated fractions of waste can replace primary fuel in lime kilns. Therefore, a constant waste quality is essential, e.g. sufficient calorific value, high reactivity, low moisture, metal, chlorine and ash content. Furthermore, the waste materials have to be suitable for the burners (multi-channel burners).

The selection of the appropriate waste fuels also depends on the desired product qualities and on the technical possibilities to inject them into the selected kiln. Their use is mainly limited by:

- the physical and chemical properties that do not always meet the relevant physical, chemical or process-specific requirements. Hence, it is impossible to burn lumps of solid fuel in PFRK kilns

- the availability on the market.

Waste fuels have to be available in sufficient quantities. Such fuels are not prepared in lime plants. Normally different types of combustible wastes or wastes with separable high calorific fractions are prepared in special waste management facilities in such way that they can be directly burned in lime kilns without any additional treatment on their production site. An exception concerns the filtering of liquid fuels, which prevents coarse particles from clogging the control valves or the burner.

The selection of fuels (fossil or waste) also has to take into account the quality requirements of the products and is highly dependent on site-specific circumstances. Therefore, only a limited number of waste fuels are suitable for the production of lime.

These waste fuels represent about 4 % of all the energy consumed by the European lime industry. In fact in 2005, the use of wastes as fuels was carried out in seven countries, which were the Czech Republic, Denmark, Finland, France, Germany, Sweden and the UK, as shown in Figure 2.12.

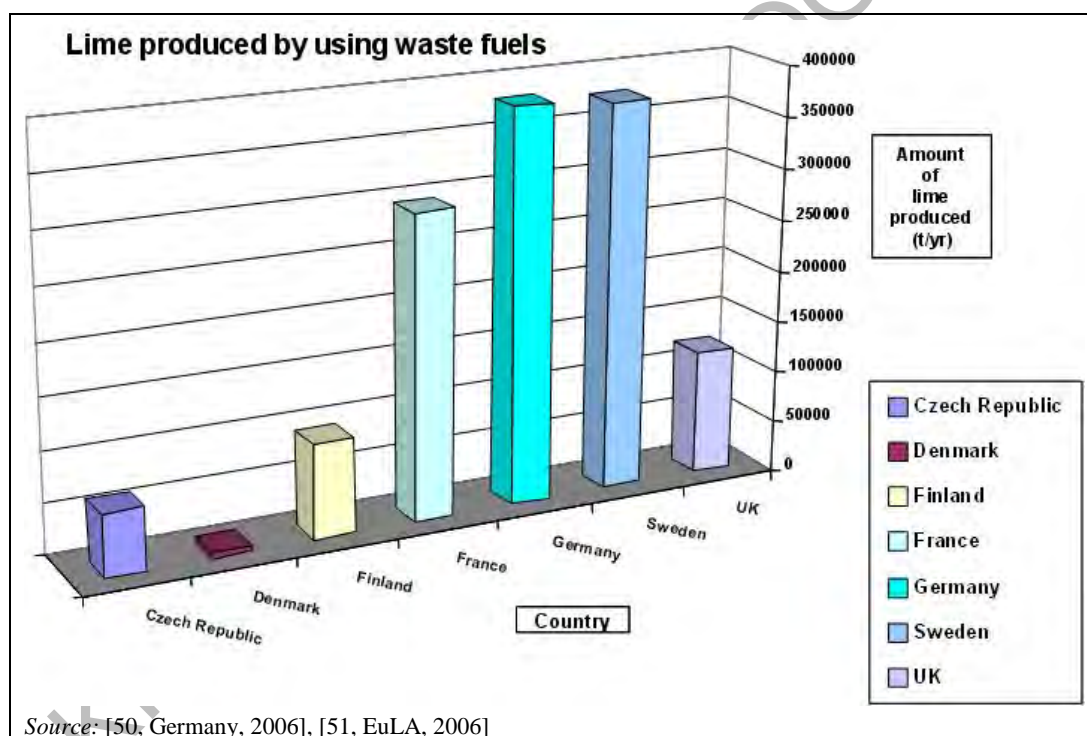


Figure 2.12: Amount of lime produced by using waste fuels in different European countries

Useful information regarding waste treatment can be found in the Reference Document on Best Available Techniques for Management of the Waste Treatments Industries [48, European Commission, 2005].

Information regarding waste incineration can also be found in the Reference Document on Best Available Techniques for Waste Incineration [87, European Commission, 2001].

### 2.2.5.2 Technical aspects

When using wastes as fuels, the lime manufacturing process is not fundamentally changed. Lime kilns can operate with very different substitution rates, such as from low levels of

substitution where waste fuels supply only a small percentage of the total energy, up to total substitution.

The use of waste can be carried out in rotary kilns (RK), annular shaft kilns (ASK), parallel flow regenerative kilns (PFRK) or other shaft kilns (OSK). The selection of the kiln type depends on the quality requirements and production capacities. Figure 2.13 shows the number and type of kilns burning waste fuels in the different European countries. More information regarding the different types of kilns used in the lime industry can be found in Section 2.2.7 of this document.

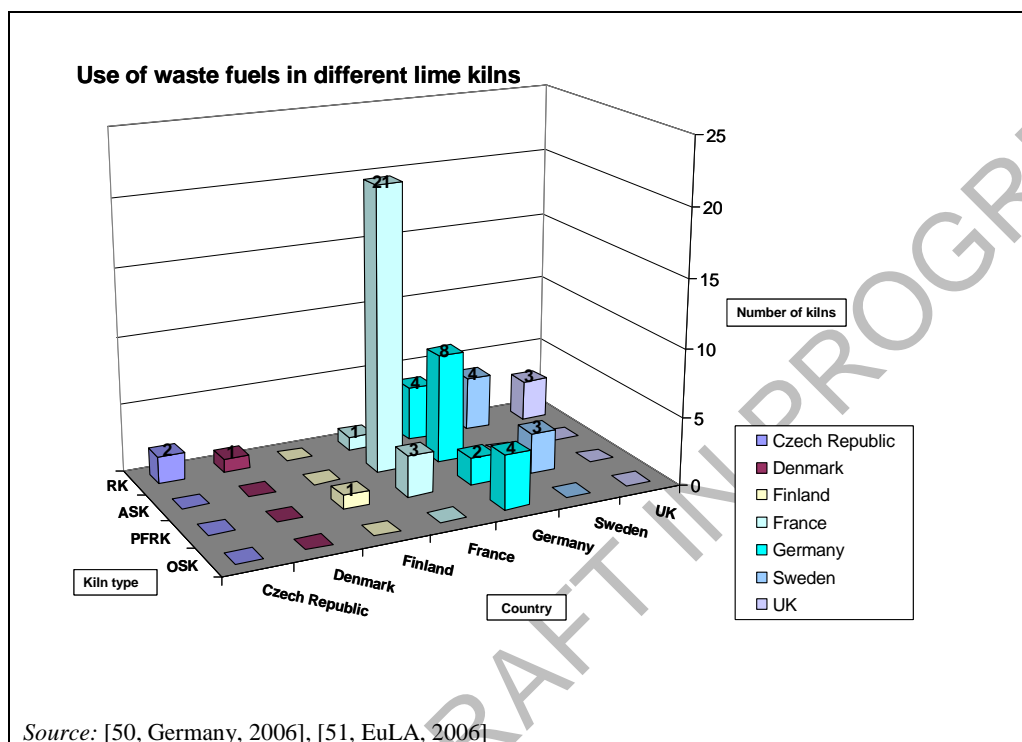
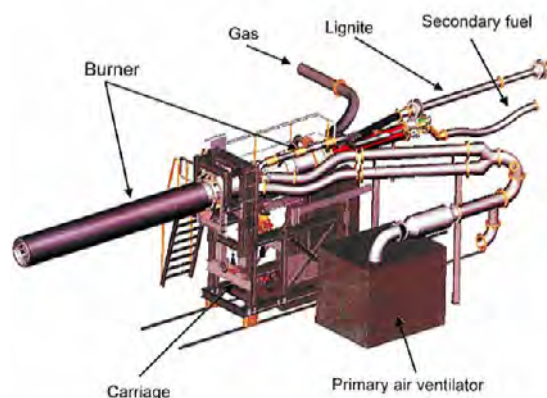
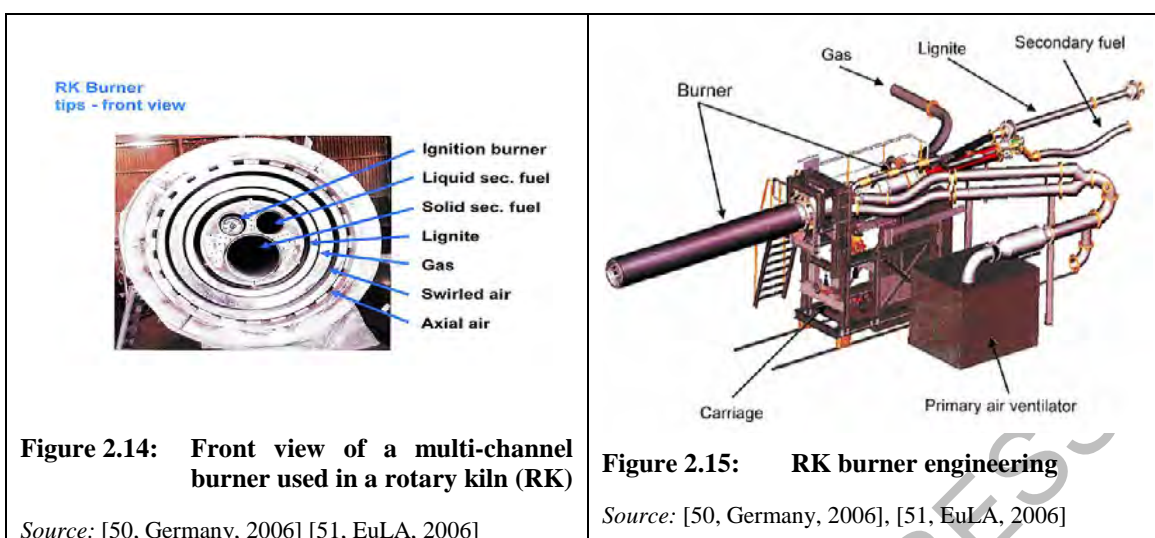


Figure 2.13: Distribution of lime kilns using waste fuels in different European countries

For using waste fuels in the above-mentioned kilns except parallel flow regenerative kilns (PFRK), special burners either for gaseous fuels or for liquid fuels have to be used. These kilns are equipped with lances specifically designed for the combustion of gaseous, liquid and solid fuels.

In rotary kilns (RK), so-called multi-channel kiln burners for firing different fuels (gaseous, solid and liquid) can also be used as shown in Figure 2.14 and Figure 2.15.





### 2.2.5.3 Types of waste fuels used

The market availability is largely responsible for the observed differences in the type of waste fuels used in different European countries, as shown in Table 2.12.

Country	Types of waste fuels		
	Liquid	Solid - pulverised	Solid - lump
Czech Republic	x		x
Denmark		x	
Finland	x		
France	x	x	x
Germany	x	x	x
Sweden	x		x
United Kingdom	x		

Source: [50, Germany, 2006], [51, EuLA, 2006]

**Table 2.12: Types of waste fuels used in different European countries**

Liquid and solid waste fuels include the following components and can be fired in different kilns as shown in Table 2.13 and Table 2.14.

Liquid waste fuels	Solid waste fuels
Waste oil	Solid derived fuels
Solvent and liquid derived fuels	Plastics (except PVC)
Animal fat	Waste wood
	Tyres
	Meat bone meal

Source: [50, Germany, 2006], [51, EuLA, 2006]

**Table 2.13: Components of liquid and solid waste fuels**

Type of kiln	Type of waste fuel		
	Liquid	Solid - pulverised	Solid - lumps
Long rotary kiln (LRK)	x	x	x
Rotary kiln with preheater (PRK)		x	x
Parallel flow regenerative kiln (PFRK)	x	x	
Annular shaft kiln (ASK)	x	x	x
Other kilns (OK)	x	x	

Source: [50, Germany, 2006], [51, EuLA, 2006]

**Table 2.14: Waste fuels used in different kiln types**

Liquid waste fuels can be used in rotary kilns (LRK, PRK), annular shaft kilns (ASK), parallel flow regenerative kilns (PFRK) and special types of other kilns (OK), e.g. regular shaft kilns with side burner and dual incline kilns. When solid fuels are pulverised, they can be used in all the above-mentioned types of kilns. Small lumps of solid fuel can only be used in rotary kilns (LRK, PRK) or annular shaft kilns. By using wastes as fuels, neither solid nor liquid wastes are produced.

The techniques used by suppliers to prepare and blend certain waste fuel qualities depend on the characteristics of the input material and the requirements of the users. The following types of non-hazardous solid wastes are treated (for example sorting, crushing, pelletising) in waste facilities for using in lime manufacturing:

- mono waste material with a high calorific value like used tyres, animal meal
- mixtures of different mono waste materials (e.g. production-specific textile or plastic waste)
- separated high calorific fraction of mixed municipal waste, mixed commercial waste or mixed construction and demolition waste.

Liquid waste fuels are prepared by blending different wastes like used solvents or waste oil with suitable calorific values in special waste management facilities. Normally only simple pretreatment (removal of bottoms, sediments and water) is necessary. In some cases, e.g. machining oil/emulsion, chemical processes are necessary to remove metallic pollutants and additives.

Useful information regarding waste treatment can be found in the Reference Document on Best available Techniques for the Waste Treatments Industries [48, European Commission, 2005]

Liquid waste fuels can be hazardous. This has to be taken into account for handling (e.g. storing, feeding) this type of fuel. Therefore, vapour recovery is used to avoid emissions of organic compounds. Vapour recovery systems are operated in a way which ensures that the flow of organic substances is permitted only upon connection of the vapour recovery system. The vapour recovery system and attached facilities release no gas to the atmosphere during normal operation, with the exception of releases necessary for safety reasons.

An example of handling and using waste oil for the firing process is described and can be found in Section 6.3 (lime manufacturing).

By using animal fat it has to be noted that due to its viscosity this waste material solidifies at temperatures of 40 °C and may plug pipes and fittings. A handling of animal fat above temperatures of above 40 °C is necessary by, e.g. using additional heating [50, Germany, 2006], [51, EuLA, 2006].

### 2.2.5.4 Quality control of solid waste fuels

Due to the specific product requirements and the nature of the production processes, waste fuels need to have very precisely defined physical properties. In lime manufacture, only waste with characteristics for this specified purpose can be used.

High calorific waste can replace primary fuels in lime kilns and therefore a constant waste quality is essential, e.g. sufficient calorific value, low moisture, metal, chlorine and ash content, and the waste has to be suitable for the burners. Such fuels are prepared in special waste management facilities.

Before preparation by the supplier, the waste material has to be checked and analysed regarding different quality characteristics, e.g. defined sufficient calorific values, low moisture content and low content of pollutants, such as sulphur, chlorine and metals because of the possible pollution into the lime as well. Examples of typical pollutant contents which are allowed to be in waste oil and animal fat used in lime manufacturing are shown in Section 6.3.2.2 (see Table 6.30). Waste fuels can be produced in different forms, such as pellets. Furthermore, before using for kiln firing, prepared and delivered waste materials are analysed as well. For analysing the different wastes, special laboratory equipment is used. An example for the quality control of solid waste fuels burned in rotary kilns is given in Section 6.3.4 [50, Germany, 2006], [51, EuLA, 2006].

To guarantee the characteristics of the waste fuel, a quality assurance system is required. In particular, this includes provisions for the sampling, the sample preparation, the analysis and the external monitoring. More useful information can be found in the technical specifications of the European Committee for Standardisation, such as CEN/TC 343 'Solid Recovered Fuels'.

The origin and classification of the waste has to be specified according to the European Waste Catalogue (EWC) [49, European Commission, 2000]. This catalogue classifies waste materials and categorises them according to how they were produced and what their characteristics are. The EWC is referred to in a number of EU Directives and Commission Decisions regarding waste management.

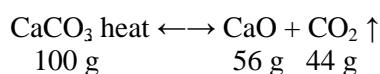
The supplier of waste has to classify the waste and has to confirm that the fuels ready for use have the characteristics specified for the purpose of lime manufacturing in different kilns.

An example for quality control is described along with the explanation of classification of waste and can be found in Section 6.3.4 [44, EuLA, 2006], [46, Germany, 2006]

## 2.2.6 Quicklime and dolomite production

### 2.2.6.1 Calcination of limestone – chemical reaction

Lime is produced by burning calcium and/or magnesium carbonates at temperatures of between 900 and 1200 °C. Furthermore, temperatures of up to 1800 °C can be possible, e.g. for achieving sintering (e.g. dead burned dolime). These temperatures are sufficiently high in order to liberate carbon dioxide and to obtain the derived oxide. This chemical reaction of calcium carbonate thermal decomposition is often referred to as 'calcination' and can be expressed as follows:



Therefore, the process depends on an adequate firing temperature of at least more than 800 °C in order to ensure decarbonisation and a good residence time, i.e. ensuring that the

lime/limestone is held for a sufficiently long period at temperatures of 1000 – 1200 °C to control its reactivity.

The reactivity of quicklime is a measure of the rate at which the quicklime reacts in the presence of water. The test method to measure the reactivity of ground lime by slaking the lime in water is described in the European standard EN 459-2. To measure the reactivity of lump lime, some other methods are used in the lime industry, such as the so-called ‘Wuhrer-Test’ [44, EuLA, 2006].

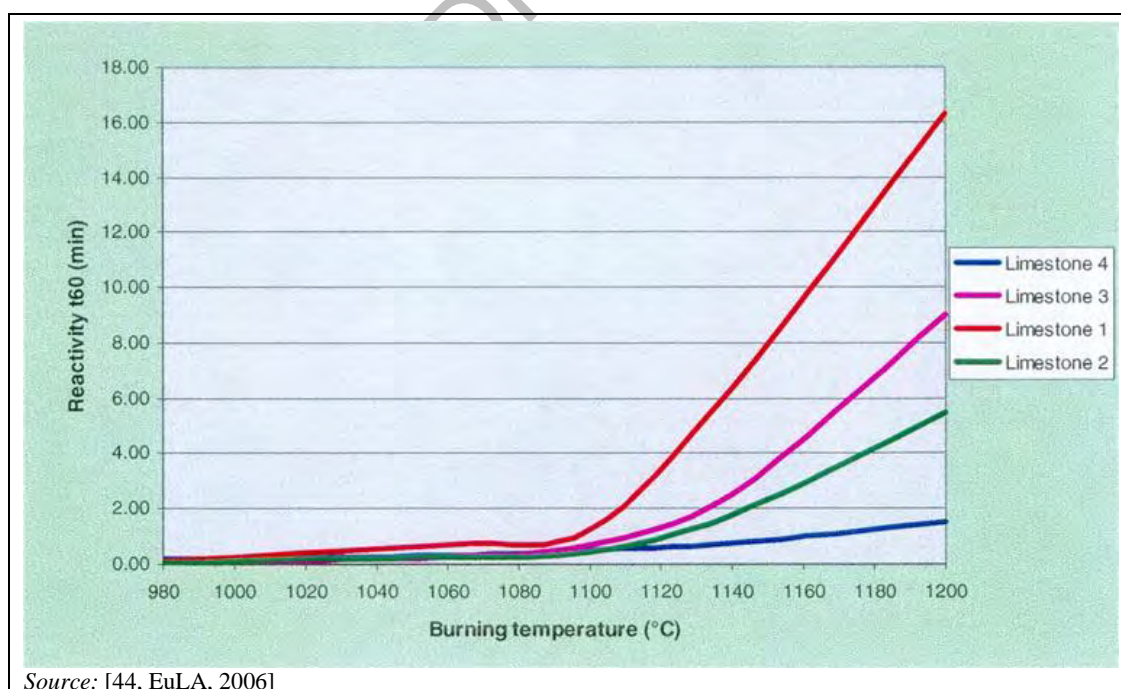
The reactivity of lime depends on different parameters related to the raw material and the process. These parameters are:

- burning temperature and time
- crystalline structure of the limestone
- impurities of the limestone
- kiln type and fuel.

The classification of lime is often seen in terms of its reactivity, such as:

- dead burned
- hard
- medium
- soft.

The European standard method for assessing the reactivity of lime is to measure the time, so-called ‘t60’, which corresponds to the time a mixture of lime and water (under standardised conditions) takes to rise from 20 to 60 °C. In practice, the higher the ‘t60’, the lower the reactivity of the lime produced. However, there are no standards to define the product quality (soft, medium, hard burned) because the borders are not clearly defined. Figure 2.16 shows the change of the reactivity (t60), as a function of the burning temperature as well as the nature of the limestone.



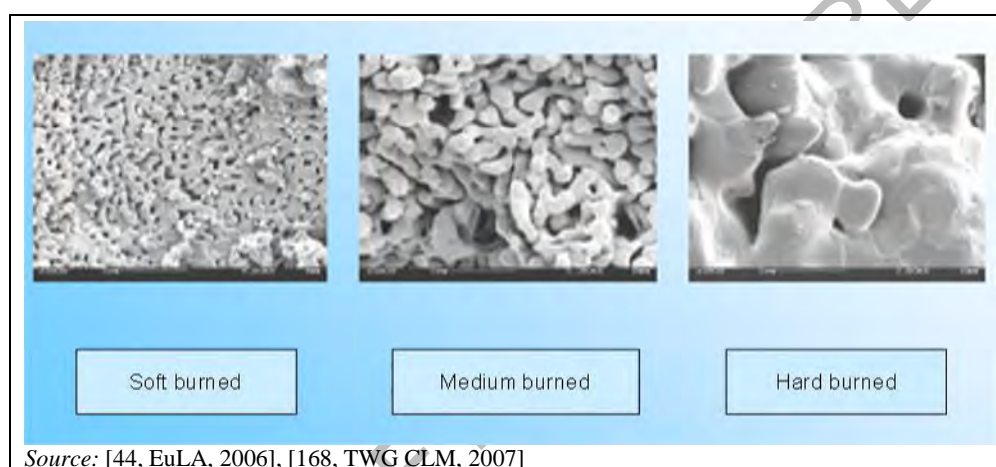
Source: [44, EuLA, 2006]

**Figure 2.16:** Change of reactivity versus burning temperature and type of limestone

Lime with a lower reactivity is often referred to as medium, hard and dead burned. The decrease of reactivity is accompanied by a reduction of the surface and the porosity of the lime, which is called sintering.

Each specific type of lime has a particular reactivity which, in turn, is governed by the requirements of the application and the specific process. As mentioned above, the characteristics of lime also depend on the limestone feed material, the type of kiln and the fuel used. For example, coke-fired shaft kilns generally produce quicklime with a medium to low reactivity, whereas gas-fired parallel flow regenerative kilns usually produce a high reactivity lime. The chemistry and reactivity of lime are the main parameters that drive the market.

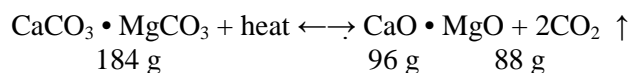
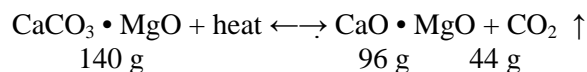
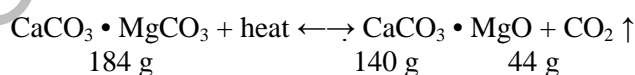
Figure 2.17 shows the difference in morphology (particle form) and surface of soft burned lime compared to medium and hard burned lime taken and scanned by a scanning electron micrograph (SEM, magnification: SEMx5000).



Source: [44, EuLA, 2006], [168, TWG CLM, 2007]

**Figure 2.17: Morphology of soft, medium and hard burned lime**

The decomposition of dolomites and magnesium/dolomitic limestone is much more complex. Decomposition can occur via a single or two discrete stages or even via intermediate stages [44, EuLA, 2006]:

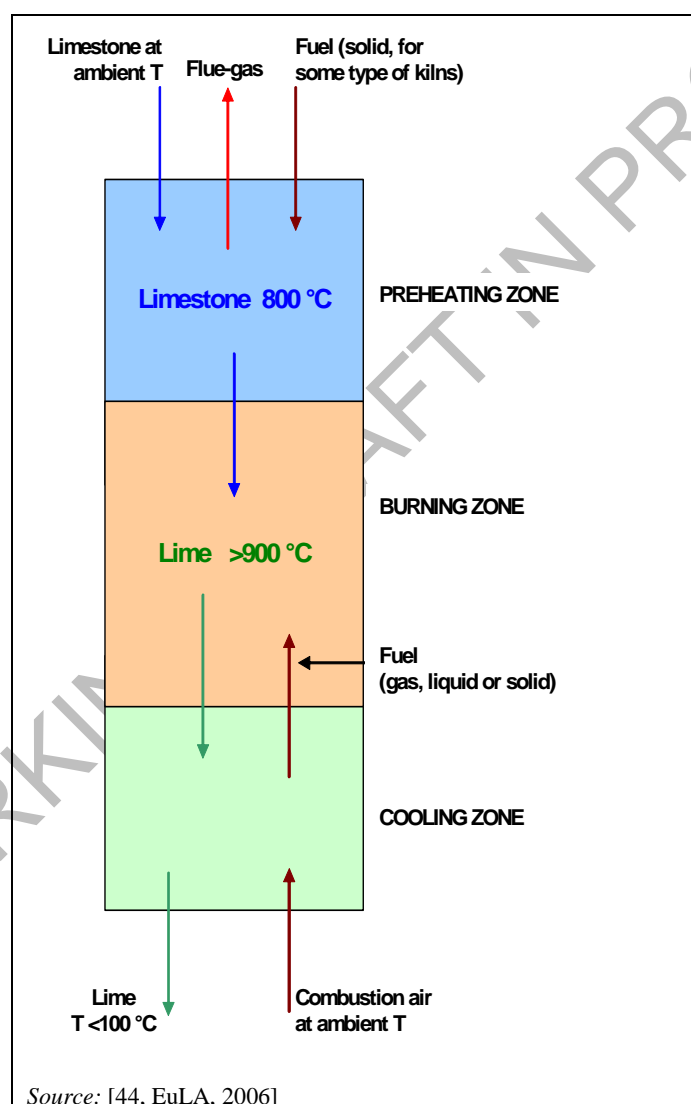


The temperature required for the decomposition of dolomites and magnesium/dolomitic limestone is usually in the range of 500 – 750 °C.

### 2.2.6.2 Calcining of limestone in the kiln

Passing limestone (with or without a significant magnesium carbonate content) through the kiln can be divided into three stages or heat transfer zones, which are illustrated in Figure 2.18 and described below:

1. *Preheating zone:* Limestone is heated from ambient temperature to about 800 °C by direct contact with the gases leaving the calcining zone composed mainly of combustion products along with excess air and CO<sub>2</sub> from calcinations.
2. *Burning zone or calcining zone:* Fuel is burned in preheated air from the cooling zone and (depending on the design) in additional ‘combustion’ air added with the fuel. In this zone, temperatures of >900 °C are produced. From 800 to 900 °C, the surface of the limestone starts to decompose. At temperatures above the decomposition temperature of limestone, i.e. 900 °C, decomposition takes place below the surface of the pebbles. At a temperature of 900 °C, these pebbles leave the calcining zone and are sometimes found as residual limestone which is still trapped inside. If the pebbles decomposed fully and still reside in the calcining zone, sintering occurs.
3. *Cooling zone:* Quicklime which leaves the calcining zone at temperatures of 900 °C, is cooled by direct contact with ‘cooling’ air, part or all of the combustion air, which in return is preheated. Lime leaves this zone at temperatures of less than 100 °C.



**Figure 2.18:** General principles of lime calcination

The residence time of the limestone lime in a kiln varies depending on the type of kiln and type of final product required. This period is found to be between six hours and two days.

Quicklime is often referred to as light or soft, medium or hard burned depending on the extent to which it has been calcined. The degree of reactivity, i.e. reactivity to water, is found to decrease as the level of porosity increases.

The rate of limestone decomposition in the kiln will, therefore, be found to depend on several factors inherent of the limestone particles themselves, i.e. morphology and composition, and of the process conditions. The main variables are found to be:

- the chemical characteristics of limestone
- the particle size and shape
- the temperature profile of the calcining zone
- the rate of heat exchange between gases and particles.

Most of the kilns used are based on either the shaft or the rotary design. There are a few other kilns based on different principles. All of these designs incorporate the concept of the three zones. Whereas shaft kilns usually incorporate a preheating zone, some other lime kilns, namely rotary kilns, sometimes operate in connection with separate preheaters. Two main types of preheaters are used, vertical shaft and travelling grate.

Most kiln systems are characterised by the countercurrent flow of solids and gases, which has implications for the resulting pollutant releases.

### 2.2.6.3 Quicklime processing

The objective of processing run-of-kiln (ROK) quicklime is to produce a number of grades with the particle sizes and qualities required by the various market segments. A number of unit processes are used, including screening, crushing, pulverising, grinding, air-classifying and conveying. A well designed lime processing plant achieves a number of objectives, namely:

- maximising the yield of main products
- minimising the yield of surplus grades (generally fines)
- improving the quality of certain products
- providing flexibility to alter the yields of products in response to changes in market demands.

The processing plant should include adequate storage, both for the products and intermediates, to provide a buffer between the kiln, which is best operated on a continuous basis, and dispatches which tend to be at low levels overnight and at weekends.

ROK lime is often screened to typically about 5 mm. If the ROK lime has a top size in excess of (say) 45 mm, it is reduced in size with the minimum production of fines. Jaw and roll crushers are widely used for this task. The crushed ROK lime is then fed to a multi-deck screen, which produces a secondary fines fraction (e.g. less than 5 mm), and granular, or 'pebble', lime fractions (e.g. 5 – 15 mm and 15 – 45 mm).

The products are stored in bunkers, from which they can be either dispatched directly, or transferred to another plant for grinding or hydrating.

#### 2.2.6.3.1 Production of milled ground quicklime

The demand for various grades and qualities of ground quicklime has grown rapidly ever since the 1950s. Particle size requirements vary from relatively coarse products used for soil stabilisation to very finely divided products for specialist applications.

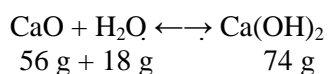
The coarser products are produced relatively cheaply in a single pass through a beater mill fitted with an integral basket. Finer products are generally produced in ball mills and vertical roller press mills. Most milling plants use air classification systems.

#### 2.2.6.4 Production of slaked and/or hydrated lime

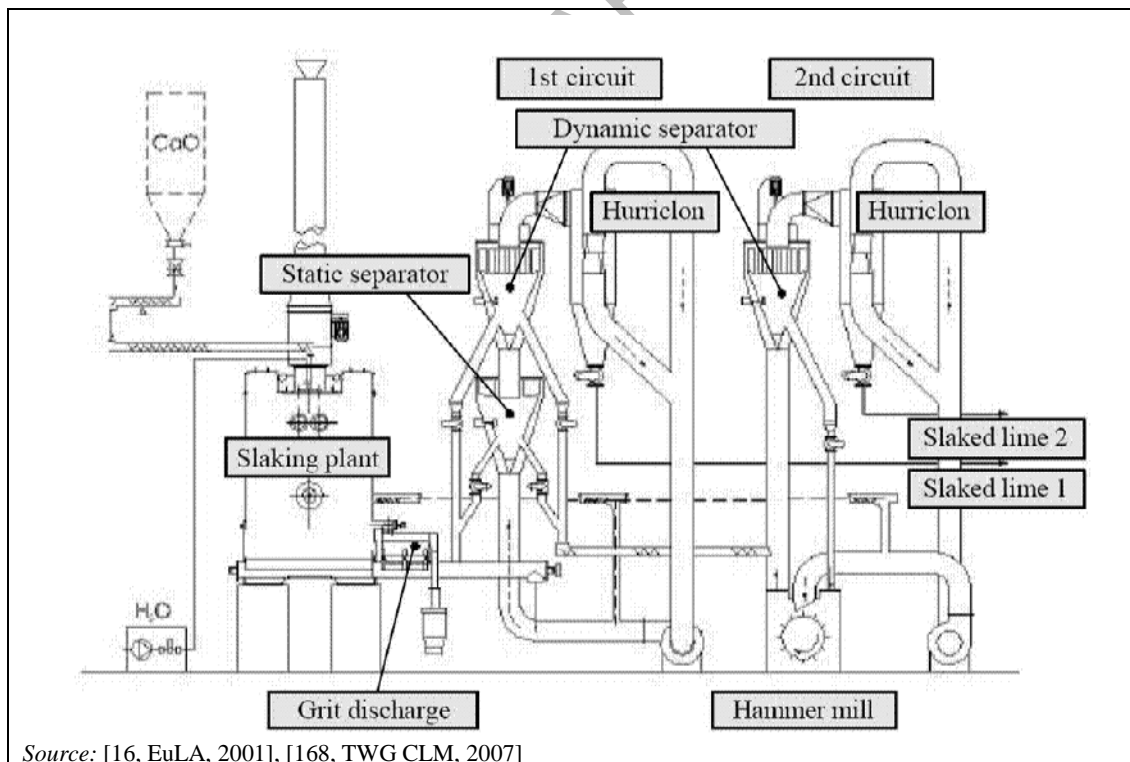
Slaked lime refers to hydrated lime (dry calcium hydroxide powder), milk of lime and lime putty (dispersions of calcium hydroxide particles in water).

##### 2.2.6.4.1 Production of hydrated lime

The hydration of lime involves the addition of water in a hydrator to calcium oxide. The quantity of water added is about twice the stoichiometric amount required for the hydration reaction. The excess water is added to moderate the temperature generated by the heat of the reaction by evaporation as shown below:



Many different types of hydrator designs exist, but the process itself can, in principle, be described as shown in Figure 2.19. The hydrator consists of, for example, rotating paddles which vigorously agitate the lime in the presence of water. A strong exothermic reaction takes place generating 1.14 MJ per kg of calcium oxide. The hydration process is regulated in such a way that the final product is a dry powder. After hydration, the product is transferred to a classifier. Some or the entire coarse fraction may be stored, ground or recycled. The products are stored in silos.



Source: [16, EuLA, 2001], [168, TWG CLM, 2007]

Figure 2.19: Flow diagram of a lime hydrator



Some hydrating plants improve the quality of hydrated lime by removing an inferior grade, consisting of a coarse, carbonate-rich fraction. These inferior grades of material are incorporated into selected products, wherever possible. Otherwise, they are sent to landfill.

#### 2.2.6.4.2 Production of milk of lime and lime putty

Milk of lime and lime putty are produced by the slaking of lime with excess water. Slaking is done in both batch and continuous slakers. The term 'milk of lime' is used to describe a fluid suspension of slaked lime in water. Milks of lime may contain up to 40 % by weight of solids. Milk of lime with a high solids content is sometimes called lime slurry. Lime putty is a thick dispersion of slaked lime in water. Putties typically contain 55 to 70 % by weight of solids. Lime paste is sometimes used to describe semi-fluid putty.

For many applications, e.g. mortars in buildings, reagents in chemical reactions, lime is used as a hydroxide, as a suspension in water (as a slurry) or as a paste.

For reasons of convenience, lime users prefer to work with hydrated lime in powder form, which is diluted in water, rather than with quicklime. The slaking process is a delicate exothermic process, needing specific equipment, which lime users prefer to avoid. Moreover, hydrated lime may be preferred over quicklime, which reacts immediately with humidity. Finally, the hydration process enables the increase of product quality (yield) by removing unburned ( $\text{CaCO}_3$ ) coarse particles or any other coarse impurities.

#### 2.2.7 Types of lime kilns – techniques and design

A large variety of techniques and kiln designs have been used over the years and around the world. Although sales of lime kilns in recent years have been dominated by a relatively small number of designs, many alternatives are available, which are particularly suitable for specific applications. Limestone properties, such as strength before and after burning, type of available fuel and product quality, must be considered when choosing a kiln technique. Many lime producers operate two or more types of kiln, using different sizes of limestone feed, and producing different qualities of lime, therefore, making better use of the natural resources, which is a good environmental practice.

There are six general types of kilns used for the manufacture of lime. Generally, the main important factors for the selection of a kiln are:

- nature of the mineral deposit
  - characteristics, availability and quality of the limestone
- input granulometry
  - mechanical properties of the kiln feed
  - fines
- customer applications regarding the lime properties
- kiln capacity
- availability of fuels (including waste fuels)
- costs (fuel, investment and operating).

Typical production rate and size of the stone feed for different types of kilns are shown in Table 2.15. The types of kilns used for lime manufacture have a general lifetime of 30 to 45 years.

Kiln type	Abbreviation	Output range (t/d)	Range of feed stone size (mm)
Long rotary kiln	LRK	160 – 1500	2 – 60
Rotary kiln with preheater	PRK	150 – 1500	10 – 60
Parallel flow generative kiln	PFRK	100 – 600	10 – 200
Annular shaft kiln	ASK	80 – 300	10 – 150
Mixed feed shaft kiln	MFSK	60 – 200	20 – 200
Other kilns	OK	10 – 200	20 – 250

Source: [16, EuLA, 2001] [44, EuLA, 2006]

**Table 2.15: Operational parameters for types of lime kilns**

The physico-chemical properties of lime are inherently linked to the type of kilns used for the calcination. Other parameters can influence the choice of the kiln, such as:

- type and availability of fuel
- kiln capacity
- investment costs
- operational costs
- environmental impact.

Table 2.16 shows the types of kilns generally used for producing specific types of lime required by the market.

Reactivity	t60 <sup>(3)</sup> < 3 min						t60 <sup>(3)</sup> > 3 min					
	<20		20 – 60		>60		<20		20 – 60		>60	
Grain size of limestone (mm)												
Content of sulphur in lime	M <sup>(1)</sup>	L <sup>(2)</sup>	M <sup>(1)</sup>	L <sup>(2)</sup>	M <sup>(1)</sup>	L <sup>(2)</sup>	M <sup>(1)</sup>	L <sup>(2)</sup>	M <sup>(1)</sup>	L <sup>(2)</sup>	M <sup>(1)</sup>	L <sup>(2)</sup>
Long rotary kiln (LRK)				+( <sup>4</sup> )					o( <sup>5</sup> )	+( <sup>4</sup> )		
Rotary kiln with preheater (PRK)				+( <sup>4</sup> )			+( <sup>4</sup> )			+( <sup>4</sup> )		
Parallel flow generative kiln (PFRK)	+( <sup>4</sup> )		+( <sup>4</sup> )			o( <sup>5</sup> )						
Annular shaft kiln (ASK)			+( <sup>4</sup> )								+( <sup>4</sup> )	
Mixed feed shaft kiln (MFSK)												o( <sup>5</sup> )
Other kilns (OK)	+( <sup>4</sup> )		+( <sup>4</sup> )		+( <sup>4</sup> )		+( <sup>4</sup> )			+( <sup>4</sup> )		

(<sup>1</sup>) M=medium: >0.05 %  
(<sup>2</sup>) L=low: <0.05 %  
(<sup>3</sup>) t60 =reactivity of lime which indicates the time needed for quicklime to be heated from 20 to 60 °C when reacting with water  
(<sup>4</sup>) The most frequently used  
(<sup>5</sup>) Used under certain conditions  
Source: [44, EuLA, 2006]

**Table 2.16: Relationship between kilns and types of lime generally produced in these kilns**

Table 2.17 shows the different product properties such as reactivity for different market sectors or consumer groups. The chemistry and reactivity of lime are the most important parameters that drive the market.

Consumer group		Production Percentage (%) in 2003 (ILA) <sup>(1)</sup>	Product properties lime				
			Reactivity		Chemistry		Content of sulphur
			t60 <sup>(2)</sup> <3 min <sup>(3)</sup>	t60 <sup>(2)</sup> >3 min <sup>(3)</sup>	Very pure	CL 70 – 80 <sup>(4)</sup>	
I.	Industry						
	1. Iron and steel	39	x		x	x	
	2. Non-ferrous	3				x	
	3. Chemical	10	x		x	x	
	4. Others (e.g. paper)	6				x	
II.	Building materials (industry) <sup>(6)</sup>	3		x		x	
III.	Building materials (trade) <sup>(6)</sup>	17		x		x	
IV.	Environmental protection <sup>(6)</sup>	16					
	1. Flue-gas treatment					x	
	2. Drinking water					x	
	3. Sewage treatment					x	
V.	Agriculture	2					
Consumer group		Percentage (%) of production in 2003 (ILA) <sup>(1)</sup>	Product properties dolomitic lime				
			Reactivity		Chemistry		Content of sulphur
					Very pure	CL 70 – 80 <sup>(4)</sup>	
I.	Steel industry		x <sup>(5)</sup>				x
II.	No application for dolime						
III.	Building materials		Half burned			DL 80 DL 85 <sup>(5)</sup>	
IV.	No application for dolime						
V.			Half burned			DL 80 DL 85 <sup>(5)</sup>	
VI.	No application for dolime						
VII.	Refractory		Dead burned				x
<sup>(1)</sup> International Lime Association <sup>(2)</sup> t60 = reactivity of lime which indicates the time needed for quicklime to be heated from 20 to 60 °C when reacting with water <sup>(3)</sup> Minutes <sup>(4)</sup> CL 70 – 80 = classification standard CL 70 = lime defined in EN 459 'Building lime' with a content of CaO + MgO >65 % CL 80 = lime defined in EN 459 'Building lime' with a content of CaO + MgO >75 % <sup>(5)</sup> DL 80, DL 85 = classification standard o DL 80 = dolime defined in EN 459 'Building lime' with a content of CAO + MgO >75 % o DL 85 = dolime defined in EN 459 'Building lime' with a content of CAO + MgO >80 % <sup>(6)</sup> 'Very pure' specification used in the UK Source: [44, EuLA, 2006]							

**Table 2.17: Indicative lime specifications by consumer groups**

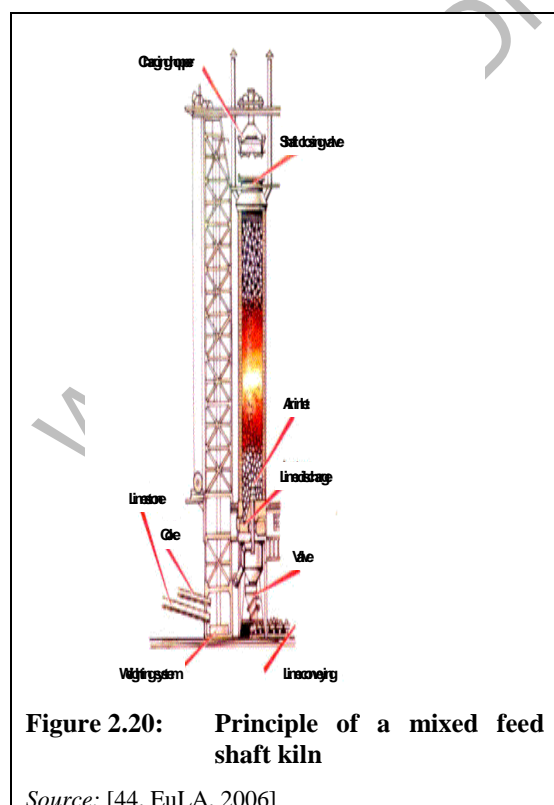
Shaft kilns constitute about 90 % of all the kilns used in Europe, which total about 551 kilns. This section describes the basic functioning of a shaft kiln with some of the differences observed in its subclasses, namely:

- mixed feed shaft kilns (MFSK)
  - 116 kilns in the EU-27, most of them located in central Europe
- parallel flow regenerative kilns (PFRK)
  - 158 kilns in the EU-27
- annular shaft kilns (ASK)
  - 74 kilns in the EU-27
- other kilns (OK)
  - 203 kilns in the EU-27.

Shaft kilns are vertical in design, up to 30 metres in height and with a diameter of up to 6 metres. For this type of kiln, the limestone is fed in at the top section of the kiln and progressively makes its way down through the different stages of the kiln until it is discharged at the bottom as lime. The performance of traditional shaft kilns has been limited by the difficulty in obtaining a uniform heat distribution over the kiln cross-section and uniform material movement through the kiln [44, EuLA, 2006].

### 2.2.7.1 Mixed feed shaft kiln (MFSK)

Mixed feed shaft kilns use limestone with a top size in the range of 20 to 200 mm and a size ratio of approximately 2:1. The most widely used fuel is a dense grade of coke with a low ash content. The coke size is only slightly smaller than that of the stone. Therefore, it moves down with the stones rather than trickling through the interstices. The stone and the coke are mixed and charged into the kiln in such a way as to minimise segregation. Anthracite is used more and more due to the price and availability of metallurgical grade coke. The working principle of a mixed feed shaft kiln is shown in Figure 2.20 and an example of such a kiln is shown in Figure 2.21.



The quality of the quicklime tends to be moderate, with the reactivity being considerably lower than that obtained by rotary kilns at the same  $\text{CaCO}_3$  level. The retention of sulphur from the fuel is high. The main technical characteristics are shown in Table 2.18.

<b>Mixed feed shaft kiln (MFSK)</b>	
Type of fuel feed	Mixed with limestone
Output (t/day)	60 – 200
Heat use (MJ/t of lime)	3400 – 4700
Energy/electricity use (kWh/t of lime)	5 – 15
Structure	Vertical cylinder or rectangular shaft with refractory lining
Grain size of limestone (mm)	20 – 200
Type of fuel	Lump coke <sup>(1)</sup> and anthracite
Combustion air injection	Only cooling air from the bottom
Drawing of lime	Rotating eccentric plate
Important points	Requires uniform mixing of stone and fuel Requires even distribution of stone over cross-section High retention of sulphur from fuel in the lime
Advantages	Unconditional Construction and maintenance costs Good tool for lime with low reactivity Low electricity requirements (fans) (see Table 2.23) Cooling air is used as combustion Low excess air High $\text{CO}_2$ for PCC <sup>(2)</sup> , sugar and soda for captive lime production
Disadvantages	Uniform fuel/air mixing difficult to achieve, producing variations in air/fuel ratio Process conditions leading to CO emissions Requires large limestone pebbles, which shorten the lifetime of the deposit Low reaction to modify parameters (24 hours), so great inertia
<sup>(1)</sup> Metallurgical coke <sup>(2)</sup> Precipitated calcium carbonate Source: [44, EuLA, 2006], [168, TWG-CLM, 2007]	

**Table 2.18: Main technical characteristics of mixed feed shaft kilns**

### 2.2.7.2 Parallel flow regenerative kiln (PFRK)

The standard PFRK's main feature is that it has two circular shafts connected by a crossover channel, although some early designs had three shafts while others had rectangular shafts. PFRKs can be designed for outputs typically between 100 – 600 t/d. Figure 2.22 and Figure 2.24 show the basic operating principle and gas flow in the PFRK and Figure 2.23 shows an example of a PFRK.

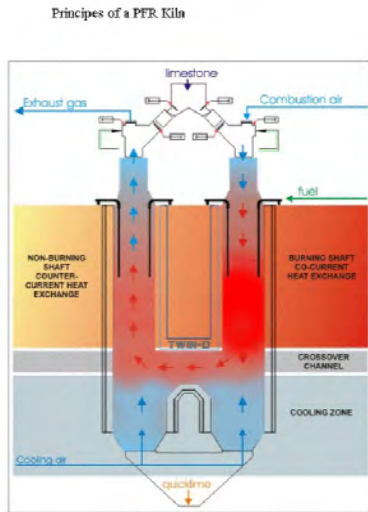


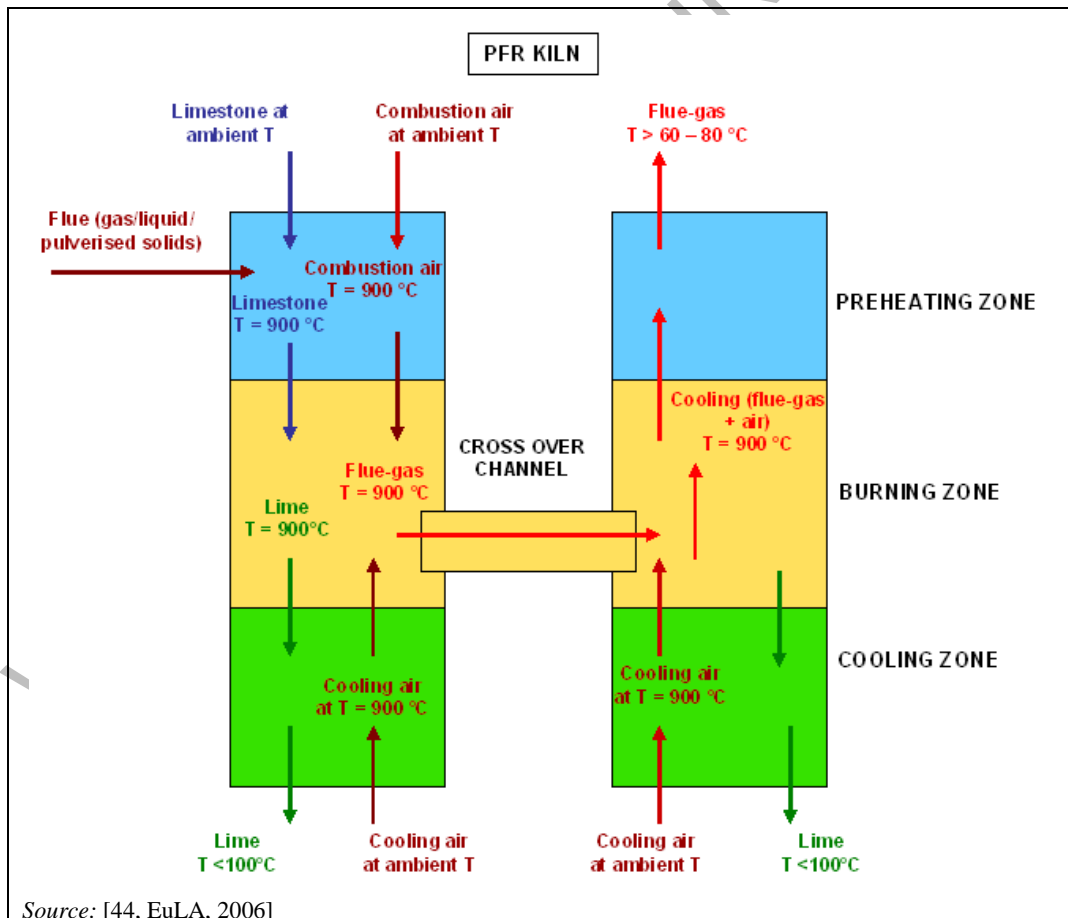
Figure 2.22: Principles of a PFRK

Source: [44, EuLA, 2006]



Figure 2.23: Example of a PFRK

Source: [44, EuLA, 2006]



Source: [44, EuLA, 2006]

Figure 2.24: Basic operating principle and gas flow in a PFRK

The method of operation incorporates two key principles:

- the preheating zone in each shaft acts as a regenerative heat exchanger, in addition to preheating the stone to calcining temperature. The surplus heat in the gases is transferred to the stone of the other shaft during the first stage of the process. It is then recovered from the stone by the combustion air, which is preheated to around 800 °C. As a consequence, the kiln has very low specific heat consumption
- the calcination of the quicklime takes place at a relatively moderate temperature, typically around 900 to 1100 °C. This makes the kilns ideally suited for producing moderate and high reactivity lime with a low residual CO<sub>2</sub> level.

In practice, batches of limestone are charged alternatively to each shaft and passed downwards through the preheating zone, around the fuel lances and then into the calcining zone. From the calcining zone, they pass finally to the cooling zone.

The operation of the kiln consists of two equal periods, which last from 8 to 15 minutes at full output. During the first period, fuel is injected through the lances at the first shaft and burns with the combustion air blown down in this shaft. The heat emitted is partly absorbed by the calcination of the limestone in this first shaft. Cooling air is blown into the base of each shaft to cool the lime. The cooling air in shaft number one, together with the combustion gases and the carbon dioxide from calcination, pass through the interconnecting cross-duct into shaft number two at a temperature of about 1050 °C. In shaft number two, the gases coming from shaft number one are mixed with the cooling air blown into the base of shaft number two and flow upwards. Thus, they heat the stone in the preheating zone of shaft number two.

If the above mode of operation were to continue, the exhaust gas temperature would rise to well over 500 °C. However, after a period of 8 to 15 minutes, the fuel and airflows in the first shaft are stopped and a 'reversal' occurs. After charging the limestone to shaft number one, fuel and air are injected into shaft number two and the exhaust gases are vented from the top of shaft number one.

The kiln can be fired with gas, liquid or solid pulverised fuels as well as waste fuels or biomass. The kiln also has a high turn down ratio, although at lower production rates there may be some loss of energy efficiency. Once a kiln has been lit, it is undesirable to shut it down as this can result in a shorter refractory life. The campaign life of the refractory in the burning and crossover channel is 4 to 8 years for most operations.

The standard PFRK requires clean stone, ideally with a stone ratio no greater than 2:1. The minimum stone size 30 mm, although a modified design called the PFRK fine lime kiln can operate on sizes as small as 10 – 30 mm on clean limestone.

Table 2.19 summarises the major technical characteristics of the PFRK.

<b>Parallel flow regenerative kiln (PFRK)</b>	
Type of fuel feed	Lances into the stone bed
Output (t/day)	100 – 600
Heat use (MJ/t of lime)	3200 – 4200
Energy/electricity use (kWh/t of lime)	20 – 41
Structure	Two or three vertical cylinders or rectangular shafts with refractory lining connected by a channel for circulation of hot gases
Grain size of limestone (mm)	10 – 200
Type of fuel	Gas, liquid or pulverised solid fuels, waste fuels or biomass
Combustion air injection	At the top (main) and lances (10 %)
Drawing of lime	Rotating eccentric plate
Important points	Quality of refractory works is very important
Advantages	Flexibility of production High lime reactivity Reasonable flexibility of reactivity from high to medium, when the limestone allows Good distribution of fuel because of the small specific cross area interested by one lance Low fuel requirements Low energy consumption (see Table 2.23) Long campaign life, stopped only after 5 to 7 years
Disadvantages	Limited stop/start flexibility Not suited to stone with high decrepitation Limited flexibility (soft and medium burned) Refractory lining more expensive than for other types of lime kilns
<i>Source: [44, EuLA, 2006]</i>	

**Table 2.19: Technical characteristics of parallel flow regenerative kilns**

### 2.2.7.3 Annular shaft kilns (ASK)

The major feature of this type of kiln is a central cylinder which restricts the width of the annulus, and together with arches for combustion gas distribution ensures good heat distribution as shown in Figure 2.25 and Figure 2.27. The central column also enables part of the combustion gases from the lower burners to be drawn down the shaft and to be injected back into the lower chamber.

This recycling moderates the temperature at the lower burners and ensures that the final stages of calcination occur at a low temperature. Both effects help to ensure a product with a low CaCO<sub>3</sub> level and a high reactivity. The annular shaft kiln (an example is shown in Figure 2.26) can be fired with gas, oil or solid fuel. The exhaust gases have a high CO<sub>2</sub> concentration.



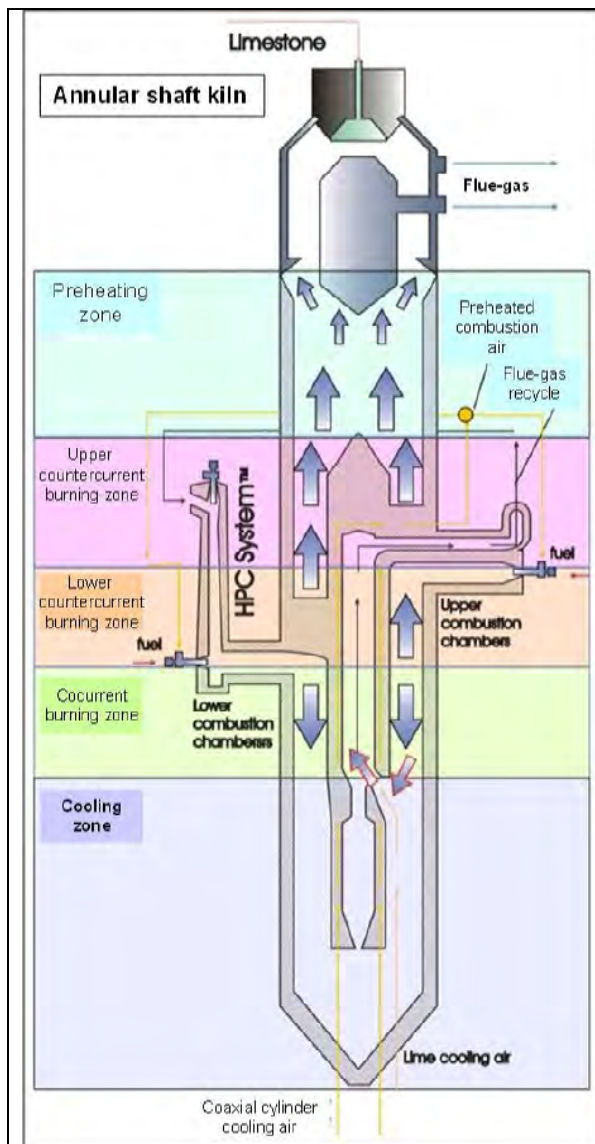


Figure 2.25: Annular shaft kiln

Source: [44, EuLA, 2006]



Figure 2.26: Example of an annular shaft kiln used in lime manufacture1

Source: [44, EuLA, 2006]

WORKING DRAFT

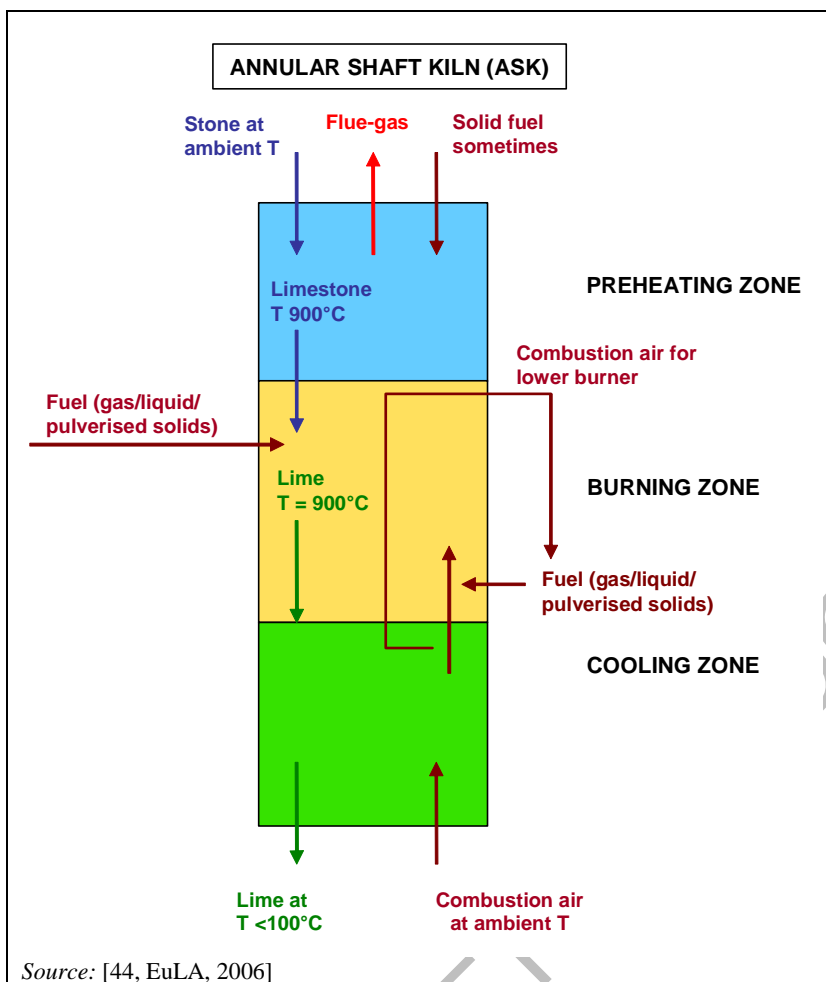


Figure 2.27: Operating principle of annular shaft kilns (ASK)

Technical characteristics of annular shaft kilns are shown in Table 2.20 [44, EuLA, 2006].

Annular shaft kiln (ASK)	
Type of fuel feed	Upper and lower burning chamber; sometimes mixed with limestone
Output (t/day)	80 – 300
Heat use (MJ/t of lime)	3300 – 4900
Energy/electricity use (kWh/t of lime)	18 – 35 (up to 50 for grain sizes of below 40 mm)
Structure	Vertical cylinder with refractory and inner cylinder External chambers and burners
Grain size of limestone (mm)	(10) 40 – 150
Type of fuel	Gas, liquid or pulverised solid fuels Waste fuels and biomass
Combustion air injection	At the top: <ul style="list-style-type: none"> <li>• duct</li> <li>• dedusting</li> <li>• fan</li> </ul>
Drawing of lime	Rotating eccentric plate
Important points	Requires very accurate process control
Advantages	Low residual CO <sub>2</sub> High to medium reactivity Fuel saving through heat recovery Central cylinder restricts the width of the annulus Good heat distribution
Disadvantages	Maintenance of heat recuperator and outer chambers Relatively high construction cost due to its conception

Source: [44, EuLA, 2006]

Table 2.20: Technical characteristics of annular shaft kilns

### 2.2.7.4 Other kilns (OK)

#### 2.2.7.4.1 Other single shaft kilns

This group of kilns includes a number of designs not described above. In these designs, fuel is introduced through the walls of the kiln, and is burned in the calcining zone, with the combustion products moving upwards countercurrently to the lime and limestone. In some designs, the fuel is partially combusted in external gasifiers. In others, it is introduced via devices such as a central burner, beam burner or injected below internal arches.

#### 2.2.7.4.2 Double inclined shaft kilns

This type of kiln can produce a reactive low carbonate product. It is essentially rectangular in cross-section but incorporates two inclined sections in the calcining zone. Opposite each inclined section, offset arches create spaces into which fuel and preheated combustion air is fired via combustion chambers.

Cooling air is drawn into the base of the kiln where it is preheated, withdrawn and re-injected via the combustion chambers. The tortuous paths for both the gases and the burden, coupled with firing from both sides, ensure an efficient distribution of heat. A range of solid, liquid and gaseous fuels can be used, although they should be selected with care to avoid excessive buildups caused by fuel ash and calcium sulphate deposits.

The major features of double inclined shaft kilns are shown in Figure 2.28.

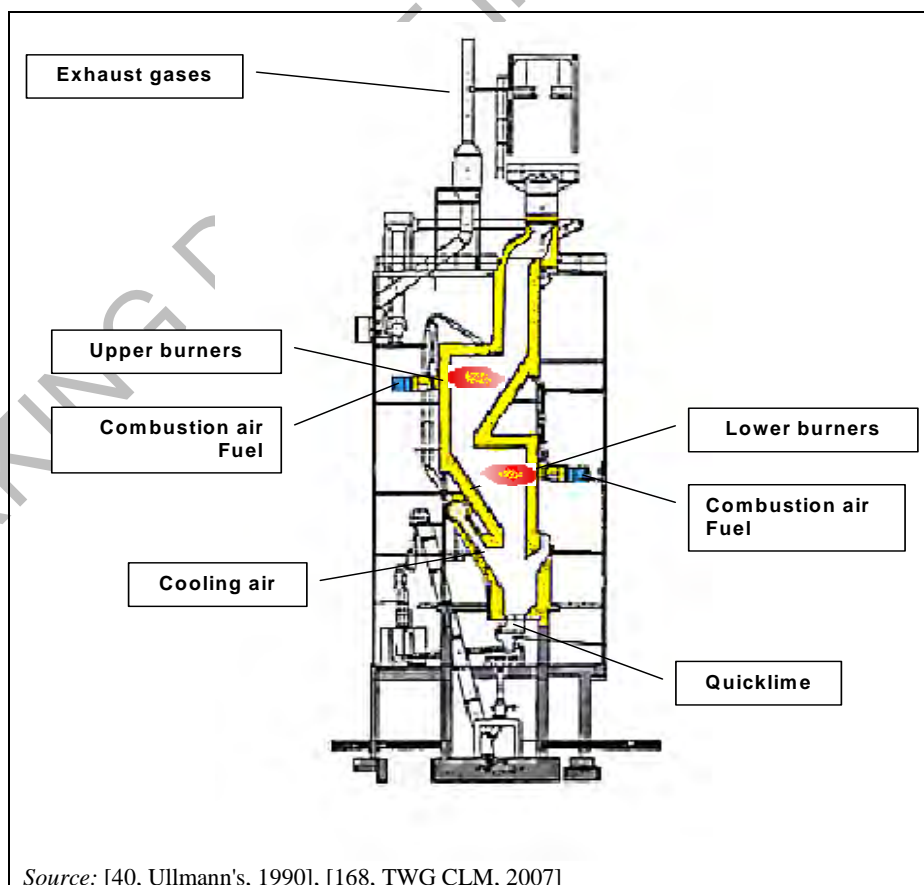


Figure 2.28: Double inclined shaft kiln

#### 2.2.7.4.3 Multi-chamber shaft kilns

This is another type of double inclined kiln. It consists of four or six alternately inclined sections in the calcining zone, and opposite of each is an offset arch. The arches serve the same purpose as in the double-inclined kiln.

Cooling air is preheated by lime in the cooling zone and is withdrawn, dedusted and re-injected via the combustion chambers.

A feature of the kiln is that the temperature of the lower combustion chambers can be varied to control the reactivity of the lime over a wide range. The kiln can be fired with solid, liquid and gaseous fuels or a mixture of different types of fuels.

#### 2.2.7.4.4 Travelling grate kilns

For limestone grains with a size range of 15 to 45 mm, an option is the 'travelling grate' or CID kiln. This kiln type was developed in Germany.

It consists of a rectangular shaft preheating zone, which feeds the limestone into a calcining zone. In the calcining zone, the limestone slowly cascades over five oscillating plates, opposite of which are a series of burners. The lime passes to a rectangular cooling zone.

The kiln can burn gaseous, liquid or pulverised fuels and is reported to produce a soft burned lime with a residual  $\text{CaCO}_3$  content of less than 2.3 %. The four kilns built to date have capacities of 80 to 130 tonnes/day of quicklime.

#### 2.2.7.4.5 Top-shaped kilns

The 'top-shaped' lime kiln is a relatively new development, which accepts feed stone in the 10 to 25 mm range. This type of kiln was developed in Japan.

This consists of an annular preheating zone from which the limestone is displaced by pushing rods into a cylindrical calcining zone. Combustion gases from a central, downward facing burner, fired with oil and positioned in the centre of the preheating zone are drawn down into the calcining zone by an ejector. The lime then passes down into a conical cooling zone.

The kiln is reported to produce high quality quicklime, suitable for steel production and precipitated calcium carbonate. Kiln capacities are up to 100 tonnes/day of quicklime. It is reported that, because of its relatively low height, the kiln can accept limestone with low strengths.

#### 2.2.7.4.6 Gas suspension calcination (GSC) kilns

Gas suspension calcination (GSC) kilns are a technique for minerals processing, such as the calcination of limestone, dolomite and magnesite from pulverised raw materials to produce highly reactive and uniform products. However in 2007, only one plant in the EU-27 used this technique. Most of the processes in the plant, such as drying, preheating, calcination and cooling, are performed in gas suspension. Consequently, the plant consists of stationary equipment and a few moving components, as shown in Figure 2.29.

The amount of material present in the system is negligible, which means that after a few minutes of operation, the product will conform to specifications. There is no loss of material or quality during start-up and shutdown so there is no subgrade product. The GSC process produces a product with high reactivity, even when calcined to a high degree.

The material to be processed in gas suspension must have a suitable fineness; practical experience has shown that 2 mm particle size should not be exceeded.

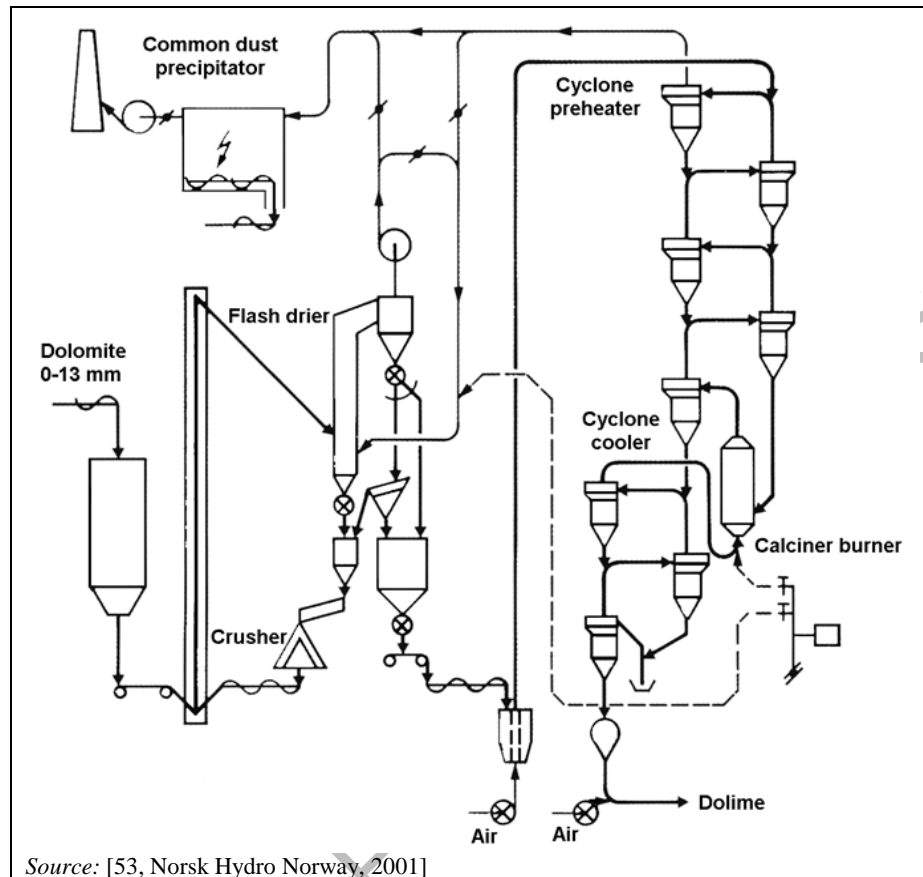


Figure 2.29: Gas suspension calcination process diagram

A GSC plant for the production of dolomitic lime has been in continuous operation at Norsk Hydro, Porsgrunn, Norway, since August 1986. Some performance figures for the balanced operation of GSC and crushing/drying are presented below [53, Norsk Hydro Norway, 2001]:

- plant capacity 430 tonnes/day
- fuel consumption 4.8 GJ/tonne product
- power consumption 33 kWh/tonne product.

#### 2.2.7.4.7 Rotating hearth kilns

This type of kiln, now almost obsolete, was designed to produce pebble lime. It consists of an annular travelling hearth carrying the limestone charge. The limestone is calcined by multiple burners as it rotates on the annular hearth. The combustion air is preheated by surplus heat in exhaust gases and/or by using it to cool the quicklime.

Due to the reduced abrasion compared to rotary and shaft kilns, rotating hearth kilns produce a high proportion of pebble lime.

#### 2.2.7.5 Long rotary kilns (LRK)

In 2008, there were about 29 long rotary kilns in the EU-27 mostly located in the north of Europe. The long rotary kiln consists of a rotating (up to 150 m long) cylinder inclined at an

angle of 1 to 4 degrees to the horizontal with a diameter of about 2 – 4.5 metres. Limestone is fed into the upper end and fuel plus combustion air is fired into the lower end. Quicklime is discharged from the kiln into a lime cooler, where it is used to preheat the combustion air. Various designs of lime coolers are used including planetary units mounted around the kiln shell, travelling grates and various types of counter-flow shaft coolers.

Figure 2.30 shows a flow diagram of a long rotary kiln and a typical countercurrent lime process; an example of this kiln type is shown in Figure 2.31. The major characteristics are shown in Table 2.21.

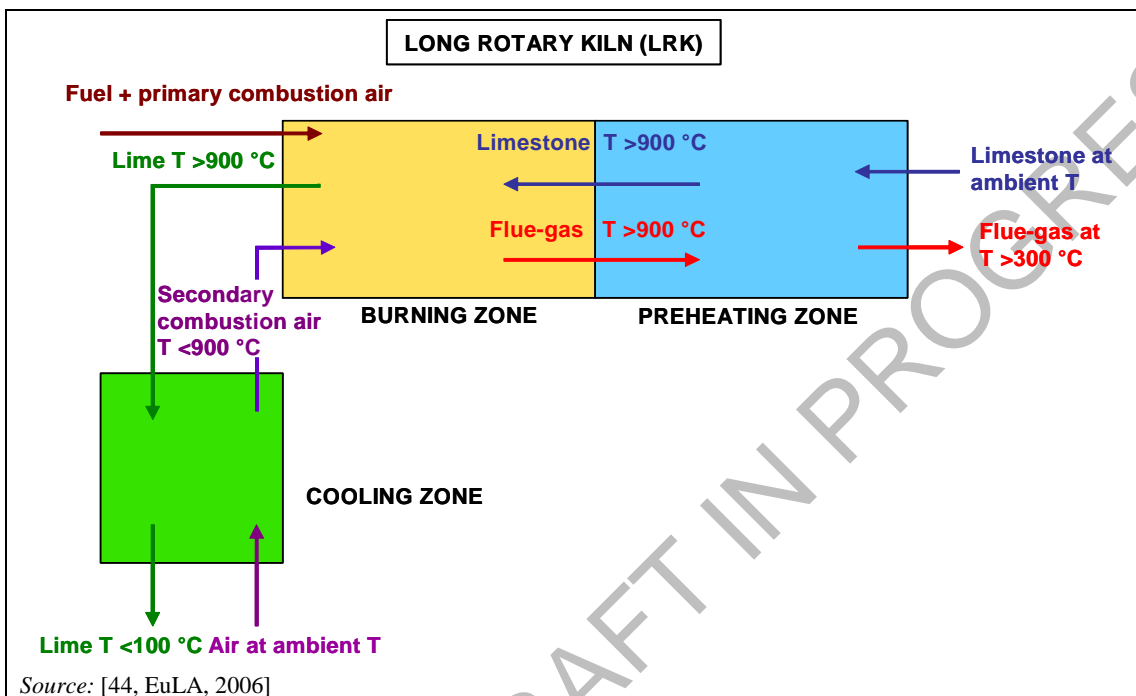


Figure 2.30: Operating principle of long rotary kilns

<b>Long rotary kiln (LRK)</b>	
Type of fuel feeding	Burner at lime discharge
Output (t/day)	160 – 1500
Heat use (MJ/t of lime)	6000 – 9200
Energy/electricity use (kWh/t of lime)	18 – 25
Structure	Inclined rotating cylinder with refractory lining ‘mixers’ to improve the heat exchange: <ul style="list-style-type: none"> <li>• up to 150 m long</li> <li>• 2 – 4.5 m in diameter</li> </ul> External chambers and burners
Type of preheater	None
Type of cooler	<ul style="list-style-type: none"> <li>• planetary around kiln shell</li> <li>• travelling grate or</li> <li>• rotating cylinder or</li> <li>• static shaft cooler</li> </ul>
Grain size of limestone (mm)	2 – 60
Type of fuel	Gas, liquid or pulverised solid fossil fuels Waste fuels and biomass
Combustion air injection	Cooling air at the extremity of the cooler and primary air with the fuel
Exhaust gas extraction	At the end of the tube, at the limestone feeding side: <ul style="list-style-type: none"> <li>• duct</li> <li>• cooling</li> <li>• dedusting</li> <li>• fan</li> </ul>
Drawing of lime	At the extremity of the cooler
Important points	Quality of refractory Fine grinding of coal to ensure good combustion and to build up reduction Continuous measurement of CO and O <sub>2</sub> necessary for good combustion and safety
Advantages	Flexibility of production Very quick reaction for modification of parameters Wide range of feedstone sizes for preservation of deposit/natural resources Very low residual CO <sub>2</sub> achievable Flexibility of reactivity from soft to hard burned, possibility to produce dead burned dolomite Fuel flexibility Weak limestone (producing a lot of fines during calcination) can be used, if they are unsuitable for use in shaft kilns
Disadvantages	High energy requirements (hot exhaust gases and high shell temperature) Formation of so-called ‘rings’ (coal ashes, calcium sulphates, clay)
<i>Source:</i> [44, EuLA, 2006]	

**Table 2.21: Technical characteristics of long rotary kilns (LRK)**



Source: [44, EuLA, 2006]

**Figure 2.31:** Example of a long rotary kiln used in lime manufacture

The design of a burner is important for the efficient and reliable operation of the kiln. The flame should be adjustable for different types of fuels.

Because of the fact that process conditions can be easily and quickly varied, long rotary kilns can produce a wider range of lime reactivity and lower residual CO<sub>2</sub> levels than shaft kilns. Relatively weak feedstones, such as shell deposits, and limestone that breaks up, are unsuitable as feed for shaft kilns but may prove to be suitable for rotary kilns.

Rotary kilns can be fired with a wide range of fuels. As heat transfer in the calcining zone is largely influenced by radiation and, as the infrared emissivities increase in the sequence gas, oil and solid fuels, the choice of fuel can have a significant effect on heat usage. Radiation and convection losses are highly relative to other designs of lime kilns which result in generally higher energy consumption compared to other types of kilns.

An advantage of the rotary kiln is that sulphur from the fuel, and to a lesser extent from the limestone, can be expelled from the kiln in the kiln gases by a combination of controlling the temperature and the percentage of CO in the calcining zone. Thus, low sulphur limes can be produced using high sulphur fuels, subject to any emission limits for SO<sub>2</sub> in the exhaust gases.

Long rotary kilns are flexible kilns regarding the use of fuels and different grain sizes of limestone particularly the finer fractions.

#### **2.2.7.6 Rotary kilns with preheaters (PRK)**

Rotary kilns can be fitted with preheaters and are generally considerably shorter than the conventional long rotary kilns (e.g. 40 to 90 m). The heat use decreases because of reduced radiation and convection losses as well as the increased heat recovery from the exhaust gases.

In 2008, there were 20 rotary kilns with preheater operating in the EU-27.

The major features of a rotary kiln with a preheater for lime manufacture are shown in Figure 2.32.



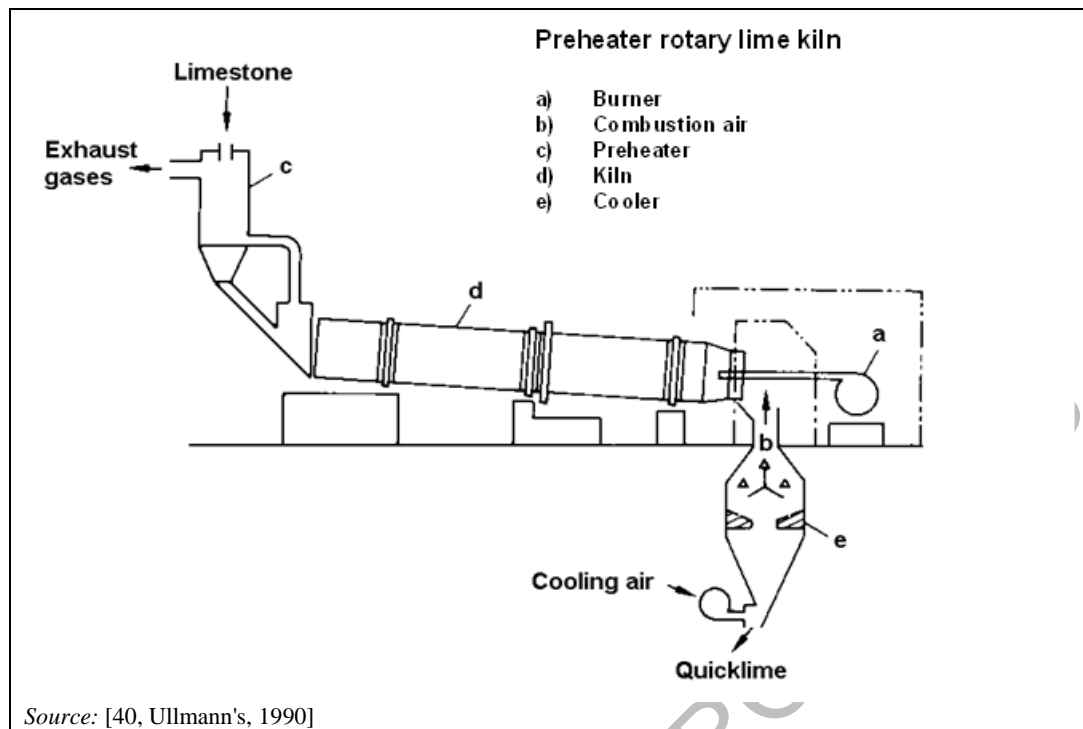


Figure 2.32: Rotary kiln with a preheater or a preheater rotary kiln (PRK)

A number of preheater designs have been developed, including vertical shafts and travelling grates. The preheater should be selected on the basis of the size and properties of the feed stone. Most can accept a bottom size of 10 mm; some have used stones down to 6 mm, and some cannot tolerate weak stones or stone that is prone to breaking up.

While the elimination of sulphur is more difficult with preheater kilns, there are a number of ways in which it can be achieved:

- operating the kiln under reducing conditions and introducing additional air at the back-end (only works with certain designs of preheater), and at the:
  - burner
  - combustion air
  - preheater
  - kiln
  - cooler
- adding sufficient finely divided limestone to the feed for it to preferentially absorb  $\text{SO}_2$  and so that it is either collected in the back-end dust collector, or is screened out of the lime discharged from the cooler.

Figure 2.33 shows a flow diagram of a typical rotary kiln with a preheater used in lime manufacture and an example of this kiln type is shown in Figure 2.34. The major technical characteristics are shown in Table 2.22.

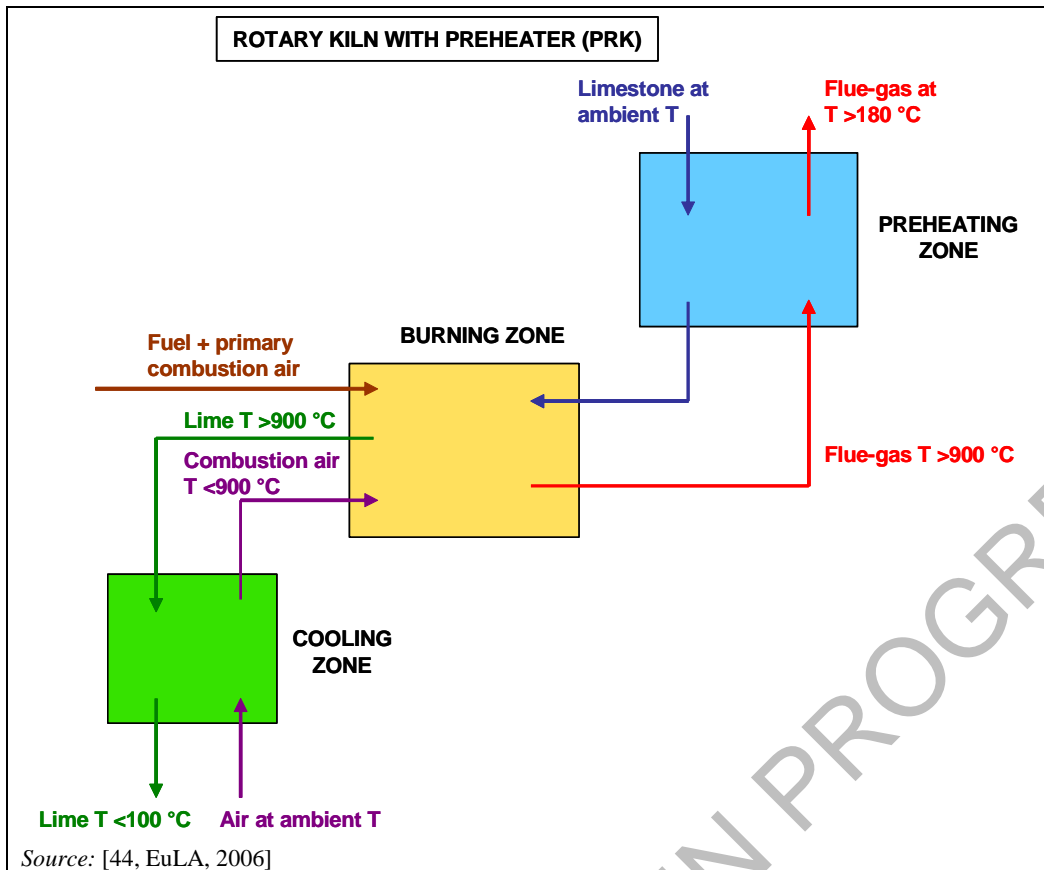


Figure 2.33: Operating principle of a rotary kiln with a preheater (PRK)



Figure 2.34: Example of a rotary kiln with a preheater

<b>Rotary kiln with a preheater/preheater rotary kiln (PRK)</b>	
Type of fuel feeding	Burner at lime discharge
Output (t/day)	100 – 1500
Heat use (MJ/t of lime)	5100 – 7800
Energy/electricity use (kWh/t of lime)	17 – 45
Structure	Inclined rotating cylinder with refractory lining ‘mixers’ to improve the heat exchange: <ul style="list-style-type: none"> <li>• maximum 90 m long</li> <li>• 2 – 4.5 m in diameter</li> </ul>
Type of preheater	Vertical shaft Moving grate
Type of cooler	Planetary around kiln shell Travelling grate rotating cylinder
Grain size of limestone (mm)	10 – 60
Type of fuel	Gas, liquid or pulverised solid fossil fuels Waste fuels and biomass
Combustion air injection	Cooling air at the extremity of the cooler
Exhaust gas extraction	Hot gases pass through the preheater: <ul style="list-style-type: none"> <li>• duct and cooling and dedusting and fan</li> </ul>
Drawing of lime	At the extremity of the cooler
Important points	Quality of refractory Fine grinding of coal to ensure good combustion and to build-up reduction Air tightness of the joint between preheater and kiln Size of limestone: too many fines may block the preheater Continuous measurement of CO and O <sub>2</sub> necessary for good combustion and safety
Advantages	Flexibility of production Very quick reaction for modification of parameters Wide range of feed stone sizes for preservation of deposit/natural resources Very low residual CO <sub>2</sub> achievable. Flexibility of reactivity from soft to hard burned, possibility to produce dead burned dolomite Fuel flexibility Weak limestone (producing a lot of fines during calcination) can be used, if they are unsuitable for use in shaft kilns Lower fuel requirements due to better heat exchange in the preheater (beginning of decarbonisation)
Disadvantages	Formation of so-called ‘rings’ (coal ashes, calcium sulphates, clay) Preheater is an additional piece of equipment to maintain
<i>Source:</i> [44, EuLA, 2006]	

**Table 2.22: Technical characteristics of preheater rotary kilns (PRK)**

## **2.2.8 Storage and handling**

### **2.2.8.1 Storage**

#### **2.2.8.1.1 Storage of quicklime**

Quicklime is preferably stored in dry conditions, free from draughts to limit air slaking. Great care is exercised to ensure that water is excluded from the lime, as hydration liberates heat and causes expansion, both of which could be dangerous.

Air pressure discharge vehicles are able to blow directly into the storage bunker, which is fitted with a filter to remove dust from the conveying air. The filter should be weatherproof and watertight. The collected dust can be discharged back into the bunker. A pressure/vacuum relief device fitted to the bunker is a precautionary measure.

All storage containers can be fitted with devices which can positively seal the base of the bunker to enable maintenance work to be done on the discharge mechanism.

Where the amount of quicklime is insufficient to justify storage bunkers the product may be stored on a concrete base, preferably in a separate bay within a building to prevent excessive air slaking.

### 2.2.8.1.2 Storage of hydrated lime

Hydrated lime absorbs carbon dioxide from the atmosphere, forming calcium carbonate and water. Therefore, it is best stored in dry draft-free conditions.

Hydrate bagged in paper sacks is preferably stored under cover to avoid deterioration by moisture, and recarbonation of the hydrated lime. When 'big bags' are used, they are also best stored under cover to prevent any damage. Pallets of bagged hydrate have been stored successfully out-of-doors; the pallet covered by a plastic sheet, the bags placed on the sheet and the pack shrink-wrapped.

Bulk hydrate is stored in silos, which must be completely weatherproof. The silo is vented via a fabric filter, which should be weatherproof and be capable of handling the delivered airflow. Where the filter is fitted on top of the silo, the collected dust is discharged back into the silo. The silo top can be fitted with an inspection manhole and a pressure relief valve. A high level indicator or alarm can be fitted to prevent over-filling. It is recommended that the base of the silo be at an angle of at least 60° to the horizontal, have a discharge aperture of not less than 200 mm and that a positive cut-off valve is fitted to the outlet to permit equipment beneath the silo to be maintained.

Because hydrated lime is prone to 'arching', suitable arch-breaking devices, such as aeration pads, vibrators and mechanical devices are fitted to prevent this. Conversely, precautions need to be taken to prevent 'flooding' of aerated powder.

### 2.2.8.1.3 Storage of milk of lime

Many customers requiring the addition of slaked lime to their process have found that milk of lime is a convenient form to store and handle. Providing certain precautions are taken, it can be handled as a liquid.

Any storage and handling system has to pay proper attention to the fact that when milk of lime is diluted with water, or when hydrated lime is dispersed in water, any carbonate hardness in the water will be deposited as calcium carbonate. Unless appropriate action is taken, this will result in scaling on the walls of pipes and on the impeller and casing of pumps. Two approaches can be adopted. Either the system can be designed to cope with scale formation, or action can be taken to prevent or minimise scaling.

It is important to prevent settling in milk of lime systems as the resulting putty can be difficult to redisperse. Storage tanks should therefore be agitated. The degree of agitation can be low and should avoid forming a vortex, which would increase absorption of carbon dioxide from the atmosphere.

The discharge pipe from a storage vessel inevitably constitutes a dead-leg and provision can be made for back-flushing with water to remove any blockages.

### 2.2.8.2 Handling

Many types of equipment are suitable for transferring the product and new ones are continually being developed. The following techniques have been used successfully, but may not be suitable for all applications.

*Skip hoists* can be used for all granular and lump grades but are more suitable for particles greater than 100 mm. *Elevators* - both belt-and-bucket and chain-and-bucket elevators have been used for all grades of quicklime. *Drag-link* conveyors are suitable for granular and fine quicklime. They are generally used for horizontal or inclined transfer. *Conveyor belts* are widely used for transferring lump and granular grades horizontally and on an upward slope. *Screw conveyors* are widely used for fine quicklime. *Vibrating trough conveyors* have been used for particle sizes up to 40 mm. They operate more successfully when there is a slight downward slope from the feed to the discharge point.

*Pneumatic conveying* can be used for products with a maximum size of up to 20 mm and often has a lower capital cost than alternatives, but the operating costs are higher. The product is fed into a rotary blowing seal connected to a blower. The pipeline bore, and volume/pressure of the blowing air, is designed taking into account the size of lime being conveyed, the transfer rate and the length/route of the pipeline. The receiving silo is equipped with an air filter and a pressure relief valve.

## 2.2.9 Other types of lime

### 2.2.9.1 Production of hydraulic limes

Natural hydraulic limes are produced from siliceous or argillaceous limestone containing more or less silica, alumina and iron. Typical levels in the limestone are  $\text{SiO}_2$ : 4 to 16 %,  $\text{Al}_2\text{O}_3$ : 1 to 8 % and  $\text{Fe}_2\text{O}_3$ : 0.3 to 6 %. The calcium plus magnesium carbonate content can range from 78 to 92 %.

The limestone is generally calcined in shaft kilns which must be controlled closely to ensure that as much of the silica and alumina as possible reacts, without sintering the free lime. Typical calcining temperatures are 950 – 1250 °C: the required temperature rises as the cementation index increases (i.e. from feebly to eminently hydraulic limes).

The calcined lime is hydrated with sufficient water to convert the free  $\text{CaO}$  into  $\text{Ca}(\text{OH})_2$ . If the free  $\text{CaO}$  content is greater than 10 to 15 %, the hard sintered lumps disintegrate into a powder. Otherwise, the lime must be ground before hydration. It may also be necessary to grind the hydrated product to achieve the required degree of fineness and setting rate.

'Special' natural hydraulic limes are produced by intimately blending powdered natural hydraulic limes with powdered pozzolanic or hydraulic materials. Artificial hydraulic limes are produced by intimately blending powdered hydrated limes with pulverised pozzolanic or hydraulic materials.

### 2.2.9.2 Production of calcined dolomite

Dolomite is calcined in both shaft and rotary kilns. Three qualities of calcined dolomite are produced – light burned, dead burned and half burned.

Light burned dolomite is generally produced in either rotary or shaft kilns. The principles of making light burned dolomite are similar to those of making high calcium quicklime. Less heat is used owing to the lower heat of calcination and the lower dissociation temperature of dolomite ( $\text{MgCO}_3$ ).

Dead burned dolomite is produced in two grades. A high purity grade, used for the manufacture of refractories, is made by calcining dolomite at temperatures of up to 1800 °C in either rotary or shaft kilns. A “fettling” grade is produced by the calcination of dolomite with 5 to 10 % iron oxide at 1400 to 1600 °C, usually in a rotary kiln. The exhaust gases from both of these processes are at higher temperatures than from other lime kilns; they are generally cooled to below 420 °C using heat exchangers, tempering air or injection of atomised water.

Half-burned dolomite ( $\text{CaCO}_3 \cdot \text{MgO}$ ) is produced by the slow calcination of dolomite at about 650 °C. It is produced in relatively small quantities and Germany is the only country in Europe to manufacture it.

### 2.2.9.3 Production of sintered dolime by the double pass process

The production of sintered dolime by the double pass process is conducted in two separate steps. Each step is conducted separately in a dedicated kiln,

- Step 1: Calcination of dolomite at material temperature between 900 and 1200°C (in most cases less than 1000 °C ). The resulting product is standard dolime used as feed material for the densification step.
- Step 2: Densification of the standard dolime produced in step 1 at material temperature higher than 1600°C. The output of the process is sintered dolime as finished product with the suitable density.

Step 1 and step 2 may both be conducted in shaft or rotary kilns. Contrary to the double pass process, in the one pass process, steps 1 and 2 are conducted in one continuous step in a unique kiln.

In the double pass process, the particularity of step 2 is that neither (or residual) calcination nor exothermic reactions occur in the kiln. Consequently, the specific heat consumption is much lower than that of normal calcination kilns (e.g., step 1) but the flue-gas and product temperatures are very high. This requires important amounts of cooling air and leads to high oxygen values in the resulting flue-gases which are approximately 20% on dry basis.

### 2.2.10 General considerations for captive lime kilns

In many other industrial sectors, such as iron and steel, sugar and paper as well as in the chemical sectors, lime is needed and some of these sectors have their own lime kilns for lime production.

#### 2.2.10.1 Lime kilns in the iron and steel industry

Most of the lime used in the iron and steel industry is for fluxing impurities in the basic oxygen furnace. Lime is also used in smaller quantities in the sinter strand process for the preparation of iron ore, in the desulphurisation of pig iron, as a fluxing agent in other oxygen steelmaking processes, in the electric arc steelmaking process and in many of the secondary steelmaking processes.

The lime kilns in the iron and steel industry are mainly shaft kilns of different designs and capacities. They do not differ in emission/consumption patterns from the non-captive lime kilns.

Useful information regarding the iron and steel industry can be found in the Reference Document on the Best Available Techniques in the Production of Iron and Steel [87, European Commission, 2001].

### 2.2.10.2 Lime kilns in the Kraft pulp industry

In 2001, there were about 100 lime kilns in the European paper industry. They are all rotary kilns with capacities of between 30 – 400 tonnes of burned lime per day. Most of the kilns are long rotary kilns, but there are also some modern preheater rotary kilns.

The long rotary lime kilns are usually fed with a slurry of calcium carbonate with a water content of 30 %. The basic fuel is normally natural gas or oil. In addition, non-condensable gases produced in several areas of the pulping process are usually burned, increasing the content of H<sub>2</sub>S, organic sulphur compounds and SO<sub>2</sub> in the stack gases. In some cases, sawdust and gases obtained by gasification of biomass are also used as fuel.

Venturi type wet scrubbers and electrostatic precipitators (for particular matter) are normally installed to clean the exhaust gases.

Useful information regarding the pulp and paper industry can be found in the Reference Document on the Best Available Technique in the Pulp and Paper Industry [124, European Commission, 2001].

### 2.2.10.3 Lime kilns in the sugar industry

Most of the lime kilns in the European sugar industry are mixed feed shaft kilns. The majority of the kilns produce 50 to 350 tonnes of quicklime per day during a sugar campaign, which, in the 1997/1998 season, lasted between 63 and 170 days, with an average of 86 days.

The quicklime and the CO<sub>2</sub> in the exhaust gas are both used in sugar factories. The gas produced by the kiln is captured and most of it is dedusted in a wet scrubber before use in the sugar process (carbonatation). Most of the CO<sub>2</sub> recombines with the milk of lime in the limed juice to give CaCO<sub>3</sub>.

The most common fuel in sugar industry lime kilns is coke. This is mainly because the product gas contains more CO<sub>2</sub> (40 – 42 % CO<sub>2</sub> by volume) than product gas from oil- or gas-fired kilns (28 – 32 % CO<sub>2</sub> by volume).

The consumption levels (limestone and fuel) for sugar industry lime kilns are about the same as for the same types of lime kiln in other sectors.

Useful information regarding the sugar industry can be found in the Reference Document on the Best Available Techniques in the Food, Drink and Milk Industries (FDM). However, information about the type and amount of lime produced as well as the kilns and fuels used is not yet covered within the FDM BREF [125, European Commission, 2006].

## 2.3 Current consumption and emission levels

The main environmental issues associated with lime production are air pollution and the use of energy. The lime burning process is the main source of emissions and is also the principal user of energy. The secondary processes of lime slaking and grinding can also be of significance, as well as subsidiary operations (namely crushing, screening, conveying, storage and discharge) and are relatively minor in terms of both emissions and energy usage.

It has to be noted that, if not otherwise mentioned in this document, for this section concerning the lime industry, the standard conditions for measurements of volume flows and concentrations of flue-gases are related to the following definitions, which are also stated in the Glossary:

m <sup>3</sup> /h	volume flow: if not otherwise mentioned in this document, the volume flows refer to 11 vol-% oxygen and standard state
mg/m <sup>3</sup>	concentration: if not otherwise mentioned in this document, the concentrations of gaseous substances or mixtures of substances refer to dry flue-gas at 11 vol-% oxygen and standard state
standard state	refers to a temperature of 273 K, a pressure of 1013 hPa and dry gas

In addition, it has to be noted that the emissions ranges refer to a reference oxygen level of 11 % although the actual oxygen level within the firing process is much lower than 11 %. The calculation formula for calculating the emissions concentration is shown below:

$$E_R = \frac{21 - O_R}{21 - O_M} * E_M$$

$E_R$  (mg/Nm<sup>3</sup>): emissions concentration related to the reference oxygen level  $O_R$   
 $O_R$  (vol %): reference oxygen level  
 $E_M$  (mg/Nm<sup>3</sup>): emissions concentration related to the measured oxygen level  $O_M$   
 $O_M$  (vol %): measured oxygen level

Additional useful information on monitoring can be found in the Reference Document on the General Principles of Monitoring (MON) [151, European Commission, 2003].

### 2.3.1 Consumption of limestone

Lime production generally uses between 1.4 and 2.2 tonnes of limestone per tonne of saleable quicklime. Consumption depends on the type of product, the purity of the limestone, the degree of calcination and the quantity of dust carried out from the kiln and the kiln exhaust gases.

### 2.3.2 Use of energy

#### 2.3.2.1 Limestone calcining

Energy use for a given kiln type also depends on several different factors, such as the quality of the stone used, the degree of conversion of calcium carbonate to calcium oxide, the size of the stone, the moisture, the fuel, the design of the kiln, the control of the process, the air tightness, etc.

The heat of dissociation of calcium limestone is 3.2 GJ/tonne for lime (about 9 % less for dolime). The net heat use per tonne of quicklime varies with kiln design. Rotary kilns generally



require more heat than shaft kilns. The heat use tends to increase as the degree of burning increases (see Section 2.2.6.1).

The use of electricity varies from a low range of 5 – 15 kWh/tonne of lime for mixed feed shaft kilns, to 20 – 40 kWh/tonne for the more advanced designs of shaft kilns and for rotary kilns. Typical heat and electrical power use by various types of lime kilns are shown in Table 2.23. The heat consumption represents about 95 % of the total energy consumption to produce lime.

Kiln type	Energy type used for lime and dolime manufacture	
	Heat use/consumption <sup>(1)</sup> GJ/tonne	Kiln electricity use kWh/tonne
Long rotary kilns (LRK)	6.0 – 9.2	18 – 25
Rotary kilns with preheater (PRK)	5.1 – 7.8	17 – 45
Parallel flow regenerative kilns (PFRK)	3.2 – 4.2	20 – 40
Annular shaft kilns (ASK)	3.3 – 4.9	18 – 35 <sup>(2)</sup> Up to 50 <sup>(3)</sup>
Mixed feed shaft kilns (MFSK)	3.4 – 4.7	5 – 15
Other kilns (OK)	3.5 – 7.0	20 – 40
<sup>(1)</sup> Heat use/consumption represents about 80 % of the total energy consumption to produce lime <sup>(2)</sup> For limestone grain sizes of between 40 and 150 mm <sup>(3)</sup> For limestone grain sizes of <40 mm <i>Source:</i> [46, Germany, 2006], [54, EuLA, 2006], [64, Czech Republic, 2006], [168, TWG CLM, 2007]		

**Table 2.23: Typical heat and electrical use by kiln types in the EU-27 for lime and dolime manufacture**

The following parameters can influence the energy consumption values given in Table 2.23:

- grain size
  - to 5 %
- limestone humidity
  - 1 to 10 %
- fuel (dry, efficiency, etc.)
  - to 5 %
- CO<sub>2</sub> residual:
  - 0.5 to 5 %
- dolime:
  - up to 9 %/lime
- hard burned lime:
  - ~10 %.

The residual CO<sub>2</sub> content in the products can affect the energy consumption. The energy consumption increases with the hardness of the products. The residual CO<sub>2</sub> content determines the use of the lime; lime with a CO<sub>2</sub> content of about 5 % is used in the steel industry, lime with a CO<sub>2</sub> content of around 1.5 % is used for exhaust gas desulphurisation.

In the special case of dead burned dolime, the energy consumption is in the range of 6.5 to 13 GJ/tonne depending on the type of kiln [54, EuLA, 2006].

To reduce the high consumption of fuel energy, different techniques were implemented at different types of lime kilns, such as:

- process optimisation and control
- reduction of excess air.

### 2.3.2.2 Lime hydrating

The hydrating process is exothermic, so excess water is added to control the temperature in the hydrators. This excess water, which is low in quantity, is converted into steam, which is discharged into the atmosphere, together with a small amount of air that is drawn into the hydrator to prevent moisture and dust from entering the plant/quicklime feed equipment, and to assist in the evaporation of excess water.

The energy requirements to operate the hydrators, air classifiers and conveying equipment amounts to approximately 5 to 30 kWh/tonne of quicklime.

### 2.3.2.3 Lime grinding

The energy use in lime grinding varies from 4 to 10 kWh/tonne of quicklime for the coarser grades (for example, those used for soil stabilisation) to 10 to 40 kWh/tonne of quicklime for the finer grades. The amount of energy required also depends on the equipment used. Fine impact mills can be used for the coarser products. Ball mills, ring-roll mills and high pressure mills plus de-agglomerators (with progressively lower specific energy use) are used for making finer products.

### 2.3.3 Emissions to air

Emissions to air and noise emissions arise during the manufacture of lime. Furthermore, emissions to water, process losses/waste arise and, in rare cases, odours. In this section, ranges of air pollutant emissions are presented for the process of lime production, including other process steps, such as storage and handling of raw materials, fuels or products.

Significant emissions to air in the manufacture of lime arise in the calcination process. The most relevant emissions to air from the calcination of limestone are:

- carbon oxides (CO, CO<sub>2</sub>)
- nitrogen oxides (NO<sub>x</sub>)
- sulphur dioxide (SO<sub>2</sub>)
- dust (PM).

The nature and concentration of the emissions is influenced by several factors, such as:

- type of kiln and kiln design
- operating or process conditions
- chemistry and quality of the raw material limestone
- the fuels used
- abatement techniques for emissions reduction.

Other emissions to air occur in the production process and these may include:

- hydrogen chloride (HCl)
- hydrogen fluoride (HF)
- organic compounds
- heavy metals
- polychlorinated dibenzo-p-dioxins and dibenzofurans (PCDD/F)
- hydrogen sulphide (H<sub>2</sub>S).

### *Type of kiln and kiln design*

The kiln type is selected, among other things, to be consistent with the size and nature of limestone available and for its ability to meet the particular quality requirements.

Kiln designs have different characteristics, such as:

- their ability to use specific types of limestone (chemistry and range of grain size)
- types of fuels used and their methods of fuel injection into the kiln
- the air to fuel ratio
- their operating temperature profiles
- their heat distribution.

Another important factor related to kiln type is the gas to solid interaction, which depends on the temperature profile in the kiln. It allows certain components in the kiln gases (most notably SO<sub>2</sub> and HCl) to react with the quicklime or limestone. These components are removed from the gas, covered in the product and leave the kiln as part of the product.

### *Process conditions*

The process parameters are selected to minimise the use of fuels and to avoid unburned limestone. The exact selected process parameters are important to achieve the product quality requirements and have an influence on the emissions.

### *Chemistry of the limestone*

The concentration of impurities and the behaviour of the stone during calcination can influence emissions. The variations of sulphur and chlorine contents in the limestone/dolomite play an important role and have an effect on the range of the SO<sub>2</sub> and HCl emissions in the exhaust gas. This depends on the type of kiln and the process conditions required to produce a certain quality of products.

### *Type of fuel*

The natural composition, such as solid, liquid and gaseous, the calorific value and combustion characteristics of the fuels used as well as the content of the different components, such as sulphur and chlorine, have an influence on the emissions to air.

An example of a fuel dosing system principle for a shaft kiln is shown in Figure 2.10 in Section 2.2.4.

### *Abatement equipment*

Lime kilns are typically fitted with abatement techniques to reduce emissions to air, e.g. dust. The type of abatement technique used depends on, e.g. the kiln type and the fuels used. Dust emissions do not only occur during the calcination process, but also in other processing operations used in lime manufacturing such as screening, crushing, milling, hydrating and packing.

In 2006, European lime producers reported up-to-date ranges of emissions to air. Typical emissions for European lime kilns are presented in Table 2.24.

Pollutant	Concentration		Ratio/tonne of lime	
	Min mg/Nm <sup>3</sup>	Max mg/Nm <sup>3</sup>	Min kg/tonne of lime	Max kg/tonne of lime
<b>Particulates</b>				
Dust	1 <sup>(2)</sup> – <10	>250	0.003 – 0.006	>1.3
<b>Gases</b>				
NO <sub>x</sub>	<50 – <100	>2500	<0.15	>12.5
SO <sub>2</sub>	<50	>2000	0	>10.0
CO <sub>2</sub>			987	1975
CO	100	>2500	<0.3	>12.5
HCl	0.02 <sup>(2)</sup> – 10	>250	0.00006	>1.3
Dioxins (average)	0.0155 ng I-TEQ/Nm <sup>3</sup>	0.0638 ng I-TEQ/Nm <sup>3</sup>	4.7*10 <sup>-8</sup>	3.2 *10 <sup>-7</sup>
<b>Heavy metals (gaseous and particulate forms) <sup>(1)</sup></b>				
Arsenic	<0.01	<0.10	<5*10 <sup>-5</sup>	<5*10 <sup>-4</sup>
Cadmium	<0.01	<0.10	<5*10 <sup>-5</sup>	<5*10 <sup>-4</sup>
Copper	<0.01	<0.10	<5*10 <sup>-5</sup>	<5*10 <sup>-4</sup>
Manganese	<0.01	<0.10	<5*10 <sup>-5</sup>	<5*10 <sup>-4</sup>
Mercury	<0.01	<0.10	<5*10 <sup>-5</sup>	<5*10 <sup>-4</sup>
Tin	<0.01	<0.10	<5*10 <sup>-5</sup>	<5*10 <sup>-4</sup>
Tellurium	<0.01	<0.10	<5*10 <sup>-5</sup>	<5*10 <sup>-4</sup>
Thallium	<0.01	<0.10	<5*10 <sup>-5</sup>	<5*10 <sup>-4</sup>
Vanadium	<0.01	>0.10	<5*10 <sup>-5</sup>	<5*10 <sup>-4</sup>
Chromium	<0.01	>0.10	<5*10 <sup>-5</sup>	<5*10 <sup>-4</sup>
Antimony	<0.01	<0.04	<5*10 <sup>-5</sup>	<2*10 <sup>-4</sup>
Selenium	<0.01	<0.06	<5*10 <sup>-5</sup>	<3*10 <sup>-4</sup>
Cobalt	<0.01	<0.06	<5*10 <sup>-5</sup>	<3*10 <sup>-4</sup>
Lead	<0.10	>1.00	<5*10 <sup>-4</sup>	<5*10 <sup>-3</sup>
Zinc	<0.10	>1.00	<5*10 <sup>-4</sup>	<5*10 <sup>-3</sup>
Emissions concentrations are averages and are indicative values based on various measurement techniques. Based on the following typical exhaust dry gas volumes, normal standard state conditions referring to a pressure of 1013 hPa and a temperature of 273.15 K, normalised for O <sub>2</sub> content of 11 %:				
<ul style="list-style-type: none"> <li>• 3000 Nm<sup>3</sup>/t lime for normal shaft kilns, annular shaft kilns and parallel flow regenerative kilns (min)</li> <li>• 3700 Nm<sup>3</sup>/t lime for rotary kilns with preheaters</li> <li>• 5000 Nm<sup>3</sup>/t lime for long rotary kilns (max)</li> </ul>				
<sup>(1)</sup> The lower range corresponds to the detection level for metals				
<sup>(2)</sup> Spot measurements				
Source: [54, EuLA, 2006], [168, TWG CLM, 2007]				

**Table 2.24: Examples of typical emissions occurring from lime kilns in Europe**

### 2.3.3.1 Dust (PM)

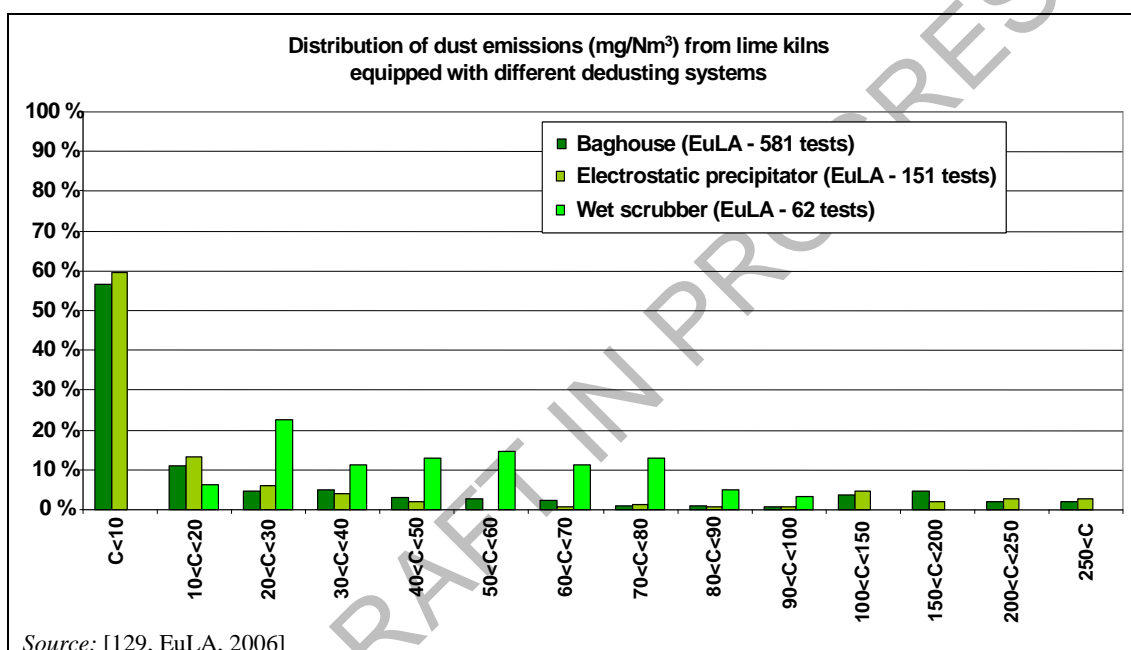
#### 2.3.3.1.1 Channelled dust emissions

##### *Calcining of limestone*

Dust (particulate matter/PM) generation arises from finely divided particles in the limestone feed, from thermal and mechanical (degradation of the lime and limestone) decrepitation within the kiln, and, to a lesser extent, from fuel ash. The levels of dust at the inlet of the dedusting equipment vary widely, depending on kiln design, capacity and raw material used among other things.

Because of the wide range of exhaust gas conditions, a variety of dust collectors are used, including cyclones, wet scrubbers, fabric filters, electrostatic precipitators and gravel bed filters. Typical cyclones remove about 90 % of the dust from lime kilns.

After abatement, emissions typically range between 10 and 250 mg/Nm<sup>3</sup>, with 20 to 100 mg/Nm<sup>3</sup> obtained using wet scrubbers. Figure 2.35 presents spot measurement results and shows that 70 % of the tests on lime kilns using ESPs and fabric filters, give dust emissions of below 20 mg/Nm<sup>3</sup> (of these, 60 % are less than 10 mg/Nm<sup>3</sup>), and that this value is only obtained for 6 % of tests on lime kilns using wet scrubbers. Furthermore, spot dust emissions from the kiln firing process in a range of between 1.4 to 2 mg/Nm<sup>3</sup> were also reported [16, EuLA, 2001], [45, Schorcht, 2006]], [46, Germany, 2006], [66, Austria, 2006], [68, EuLA, 2006], [71, Hungary, 2006].



**Figure 2.35:** Dust emissions measured from different types of lime kilns using different types of dust abatement techniques in the EU-27 (spot measurements as half hourly values)

In Germany, all shaft kilns are equipped with fabric filters. After flue-gas abatement with fabric filters, dust emissions typically range from <10 to <20 mg/Nm<sup>3</sup> (spot measurements, standard state, 10 % O<sub>2</sub> when using waste). Fabric filters achieving these levels have an air:cloth ratio ranging from <1 to 1.2 m<sup>3</sup>/m<sup>2</sup>·min. Rotary kilns are equipped with ESPs. The typical range of emissions is less than 20 mg/m<sup>3</sup>. The separated dust from fabric filters or ESPs is mostly used as product. Dust emissions in the clean gas after wet scrubbers and gravel bed filters were used in Germany and were typically in the range from 30 to 60 mg/Nm<sup>3</sup> measured as daily average values under standard conditions. However, in order to achieve a dust emission level of less than 20 mg/Nm<sup>3</sup>, wet scrubbers and gravel bed filters were replaced by fabric filters. Measures shows that the dust emission values do not depend on the type of fuel used, i.e. fossil or waste origin. In the case of waste used as fuels, e.g. in shaft kilns, dust emissions range from <5 to <10 mg/Nm<sup>3</sup> as daily average values [46, Germany, 2006].

### Lime hydrating

The gaseous effluent from hydrating plants is rather small in volume; levels are around 800 m<sup>3</sup>/tonne hydrated lime, but it may contain 2 g/m<sup>3</sup> of dust before abatement. Thus, the generation of dust can be about 1.6 kg/tonne hydrated lime. Both wet scrubbers and fabric filters are used to dedust the emissions. The moisture content of the emissions may influence the

emission level. For this reason, wet scrubbers are often used in hydrating plants. By using new generations of wet scrubbers, emission levels after abatement range from 10 to 30 mg/Nm<sup>3</sup>, corresponding to approximately 0.008 to 0.024 kg/tonne hydrated lime. In the UK in 2007, three of the most modern wet scrubbers showed results of 11 mg/Nm<sup>3</sup>, 17 mg/Nm<sup>3</sup> and 18 mg/Nm<sup>3</sup>. However, dust emissions of up to 60 mg/Nm<sup>3</sup> were also reported (expressed in wet conditions) [168, TWG CLM, 2007], [177, EULA, 2008].

### *Lime grinding*

Air is drawn through all of the grinding equipment to remove ground/milled lime of the required particle size. The product is separated from the air in fabric filters, often preceded by cyclones. Thus, dust collection is an integral part of the process. After abatement, dust emissions typically range between <10 and 50 mg/Nm<sup>3</sup>. In Germany, emission values from the lime grinding process are typically below 20 mg/Nm<sup>3</sup>.

### *Connected and subsidiary processes/operations*

Nearly all connected and subsidiary processes of a lime plant can generate dust emissions, such as crushing, screening, conveying, slaking, storage and discharge. Dust emissions are controlled by containment. The air is passed through and regularly separated in fabric filters, e.g. for the following processes:

- primary/secondary crusher
- limestone storage
- grinding mills for quicklime
- screening machines
- quicklime storage silos
- storage of solid fuels (e.g. pulverised lignite)
- handling of quicklime.

The collected dust is generally returned to the product. Equipment for the grinding and handling of quicklime is kept under slight suction. Dust emission values from these sources are reported to be in a range of less than 10 to 20 mg/m<sup>3</sup> which can safely be achieved.

#### **2.3.3.1.2 Diffuse dust emissions**

Diffuse dust emissions mainly arise from the storage and handling of raw materials, fuels and lime and from vehicles at the manufacturing site. A simple and linear site layout is advisable to minimise possible sources of diffuse dust.

Diffuse dust from, for example, stock piles of raw materials and solid fuels can cause problems, which can be reduced by using the following techniques:

- sufficient humidification of stockpiles, charging points and discharging points
- use of conveyor belts with adjustable heights.

Conveyors and elevators are constructed as closed systems, if dust emissions are likely to be emitted from dusty material. Roads within the plant area used by lorries are paved and cleaned periodically in order to avoid diffuse dust emissions. In addition, spraying with water at the installation site is also carried out. Wherever possible, closed storage systems are used. To reduce diffuse dust emissions during loading burned lime, an example is to use flexible filling pipes equipped with a dust extraction system. These flexible filling pipes are equipped with exhausting devices that guarantee dust-free loading. They are positioned to the loading floor of the lorry from where they move automatically upwards until a programmed filling height is

reached. After the lorry moves forward about 30 cm, the flexible filling pipe is positioned and loading starts again [46, Germany, 2006], [66, Austria, 2006].

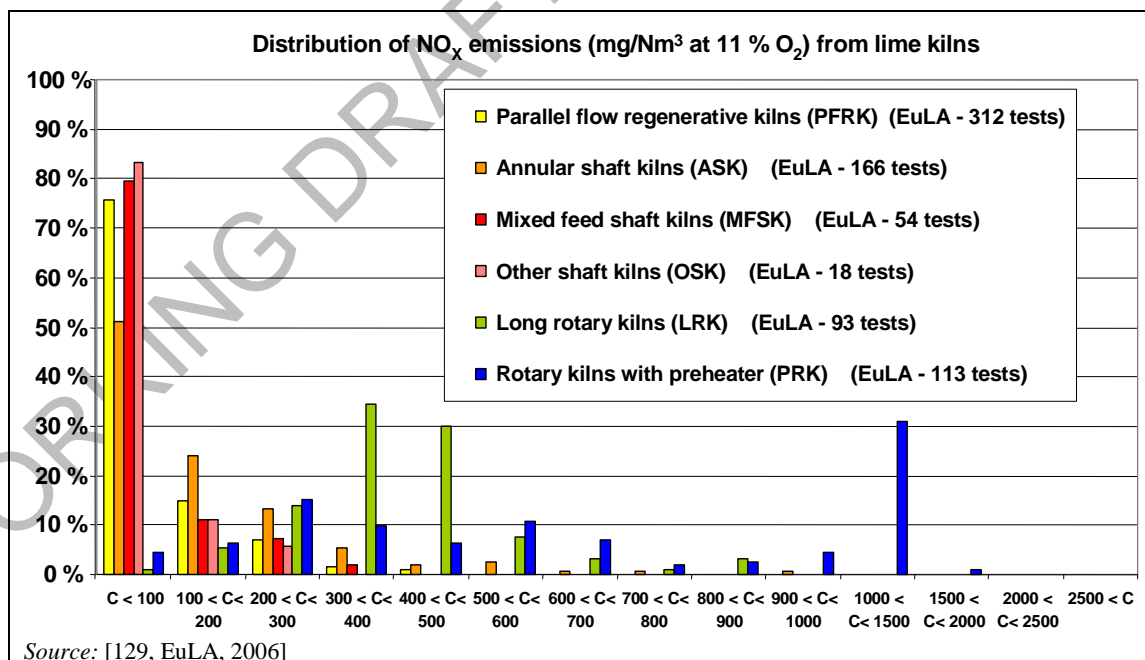
### 2.3.3.2 Nitrogen oxides

NO and NO<sub>2</sub> are the dominant nitrogen oxides (NO<sub>x</sub>) detected in the flue-gas of rotary kilns producing lime, although they can arise from the fuel during combustion. There are two main sources for the formation of NO<sub>x</sub>:

- thermal NO<sub>x</sub> is mainly produced by the high temperature reaction of nitrogen and oxygen in the combustion air (thermal NO<sub>x</sub>), a process which is highly dependent on temperature and fuels used
- fuel NO<sub>x</sub> results from the reaction between the nitrogen compounds present in the fuel with the oxygen of the combustion air.

Thermal NO<sub>x</sub> forms at temperatures above 1000 °C, i.e. in the burning zone of the kiln, where the temperatures are sufficiently high. The amount of thermal NO<sub>x</sub> produced increases with higher temperatures and growing oxygen contents in the burning zone. Since kilns producing hard or dead burned lime with low reactivity have to be operated with higher temperatures in the burning zone, they tend to generate more thermal NO<sub>x</sub> than kilns producing soft burned lime with high reactivity. Because of this temperature dependence, NO<sub>x</sub> emissions in vertical shaft kilns are generally lower than in rotary kilns, as shown in Figure 2.36.

Fuel NO<sub>x</sub> is generated by the oxidation of the nitrogen compounds present in the fuel. Depending on the combustion conditions, fuel nitrogen either combines with other nitrogen atoms to form N<sub>2</sub> or reacts with oxygen to form NO<sub>x</sub>. In the burning zone of rotary kilns, temperatures are usually high enough to promote some oxidisation of the fuel nitrogen into fuel NO<sub>x</sub>.



**Figure 2.36:** NO<sub>x</sub> emissions measured from different types of lime kilns in the EU-27 (spot measurements as half hourly values)

As shown in Figure 2.36, NO<sub>x</sub> emissions from rotary kilns range from between 300 and 2000 mg/Nm<sup>3</sup> depending on the kiln type, the fuels used and the lime type produced. Spot measurements show that of these tests, 68 % of the NO<sub>x</sub> emissions from rotary kilns are below 500 mg/Nm<sup>3</sup>. NO<sub>x</sub> emissions from shaft kilns range from between <100 and 500 mg/Nm<sup>3</sup>

depending on the kiln type used and the lime type produced. Spot measurements show that of these tests 60 % of the NO<sub>x</sub> emissions from shaft kilns are below 100 mg/Nm<sup>3</sup>. Furthermore, around 80 % of PFRKs, MFSKs and OSKs and approx. 50 % of ASKs achieve NO<sub>x</sub> emission values of <100 mg/Nm<sup>3</sup> measured as half hourly values.

*Rotary kilns (long rotary kilns (LRK) or rotary kilns with preheater (PRK))*

The flame is well defined and flame temperatures are higher than in shaft kilns. Because of the heat transfer processes, the maximum temperature of the kiln gases is also high, resulting in increased thermal NO<sub>x</sub> levels.

Dead burned dolime is mainly produced in rotary kilns. The process requires higher temperatures, therefore resulting in still higher NO<sub>x</sub> levels.

NO<sub>x</sub> emissions for these kilns range usually from 300 up to 2000 mg/Nm<sup>3</sup> depending on the type of lime/dolime produced (soft to hard burned) and are dependent upon the content of nitrogen in the fuels, the process temperatures, excess air and the manufactured product. Based on a specific flue-gas flow of:

- 5000 Nm<sup>3</sup>/t at 11 % O<sub>2</sub> for LRK
- 4000 Nm<sup>3</sup>/t at 11 % O<sub>2</sub> for PRK,

the specific nitrogen oxide flow is in the range of between 1.5 and 10 kg/t lime for LRK and 1.2 and 8 kg/t lime for PRK.

*Shaft kilns (other kilns (OK), mixed feed (MFSK), annular (ASK), and parallel flow regenerative (PFRK))*

Shaft kiln types emit less NO<sub>x</sub> than rotary kilns because temperatures in shaft kilns are usually below 1400 °C, so that formation of thermal NO<sub>x</sub> is comparatively lower.

In addition, combustion processes usually generate relatively lower flame temperatures than rotary kilns which, together with low intensity mixing conditions, result in lower levels of fuel NO<sub>x</sub>.

NO<sub>x</sub> emissions for these kilns range usually from 100 up to 500 mg/Nm<sup>3</sup> depending on the type of lime/dolime produced. Based on a specific flue-gas flow of:

- 3000 Nm<sup>3</sup>/t (11 % O<sub>2</sub>) for PFRK and ASK
- 2500 Nm<sup>3</sup>/t (11 % O<sub>2</sub>) for MFSK and OK,

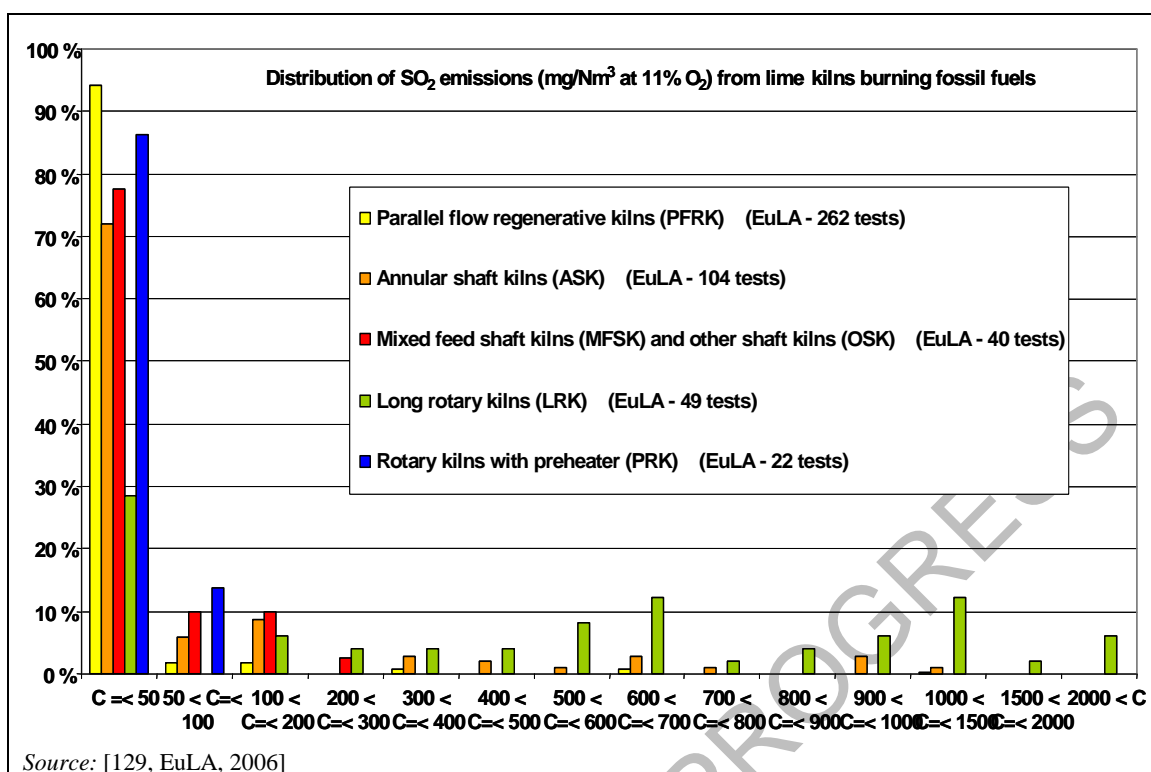
the specific nitrogen oxide flow is in the range of between 0.3 and 1.5 kg/t lime for PFRK/ASK and 0.25 and 1.3 kg/t lime for MFSK/OK.

However, where shaft kilns are used to produce hard burned calcium lime, or dead burned dolomite, higher NO<sub>x</sub> emission levels of up to 2000 mg/Nm<sup>3</sup> can be found.

### 2.3.3.3 Sulphur dioxide

In the majority of lime burning operations, the quicklime captures most of the sulphur from the limestone and the fuel. The efficient contact between the kiln gases and the quicklime usually ensures efficient absorption of sulphur dioxide. Typical SO<sub>2</sub> emissions of less than 50 mg/Nm<sup>3</sup> as a half hourly average value are reported from lime kilns in the EU-27, and these depend on the kiln used for lime production as shown in Figure 2.37.

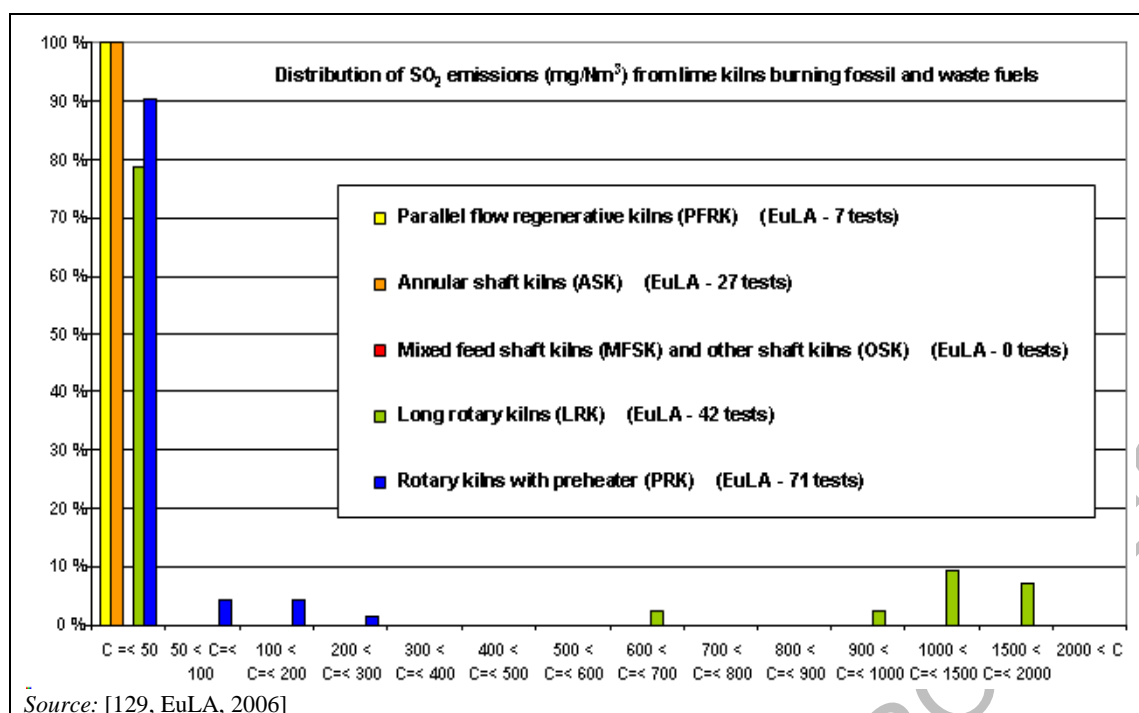




**Figure 2.37:** SO<sub>2</sub> emissions measured from different types of lime kilns using fossil fuels in the EU-27 (spot measurements as half hourly values)

As shown in Figure 2.37, SO<sub>x</sub> emissions from rotary kilns range from between 50 and 2000 mg/Nm<sup>3</sup> depending on the kiln and the fuel type used and the lime type produced. Spot measurements show that of these tests, 63 % of the SO<sub>x</sub> emissions from rotary kilns are below 500 mg/Nm<sup>3</sup>. SO<sub>x</sub> emissions from shaft kilns range from between <50 and 1000 mg/Nm<sup>3</sup> depending on the kiln type used and the lime type produced. Spot measurements show that of these tests, 87 % of the SO<sub>x</sub> emissions from shaft kilns are 50 mg/Nm<sup>3</sup> or below. Furthermore, spot measurements show that of these tests, more than 90 % of the SO<sub>x</sub> emissions from PFRK are <50 mg/Nm<sup>3</sup> and 90 % of the SO<sub>x</sub> emissions from OSK are <200 mg/Nm<sup>3</sup> (measured as half hourly values). Furthermore, nearly 90 % of rotary kilns with preheaters (PRK), approximately 78 % of annular shaft kilns (ASK), other shaft kilns (OSK) and mixed feed shaft kilns (MFSK) achieve a value of 50 mg/Nm<sup>3</sup> or below (measured as half hourly value).

It has to be noted that by using waste fuels for firing, 100 % of PFRK and ASK, 90 % of PRK and approx. 80 % of LRK achieve SO<sub>x</sub> emissions of 50 mg/Nm<sup>3</sup> or less (measured as a half hourly average value) as shown in Figure 2.38.



**Figure 2.38:** SO<sub>2</sub> emissions measured from different types of lime kilns using fossil fuels and waste fuels for kin firing in the EU-27 (spot measurements as half hourly values)

#### Long rotary kilns (LRK)

Long rotary kilns have the ability to produce low sulphur quicklime in a reducing atmosphere. In this case, part of the sulphur in the fuel and limestone is expelled as sulphur dioxide mainly in the exhaust gases.

SO<sub>x</sub> emissions for these kilns range usually from 50 up to 1500 mg/Nm<sup>3</sup> depending on the type of fuel used and on the reducing or oxidising atmosphere in the kiln which is necessary for different product qualities. The higher emissions are linked to high sulphur fuels as low sulphur fuels are not always available to the operator. Based on the specific flue-gas flow of 5000 Nm<sup>3</sup>/t (11 % O<sub>2</sub>) the specific sulphur oxide flow is in the range of between 0.3 and 7.5 kg/t lime.

#### Rotary kilns with a preheater (PRK)

Rotary kilns with a preheater also have the ability to produce low sulphur quicklime in a reducing atmosphere but, in this case, part of the sulphur in the fuel is mainly captured by lime and in the dust. Therefore, the sulphur emissions are lower than for the LRK.

SO<sub>x</sub> emissions for these kilns range usually from 50 up to 400 mg/Nm<sup>3</sup> depending on the type of fuel used and on the reducing or oxidising atmosphere in the kiln which is necessary for different product qualities. Based on the specific flue-gas flow of 4000 Nm<sup>3</sup>/t (11 % O<sub>2</sub>) the specific sulphur oxide flow is in the range of between 0.2 and 1.6 kg/t lime.

#### Shaft kilns (other kilns (OK), mixed feed (MFSK), annular (ASK), and parallel flow regenerative (PFRK))

In shaft kilns, efficient contact between kiln gases and quicklime usually ensures efficient absorption of sulphur dioxide (which can lead to high sulphur quicklime with high sulphur content fuel).

SO<sub>x</sub> emissions for these kilns range usually from 50 up to 400 mg/Nm<sup>3</sup> depending on the type of fuel used, except for ASK where the maximum is 1000 mg/Nm<sup>3</sup>. Based on a specific flue-gas flow of:

- 3000 Nm<sup>3</sup>/t (11 % O<sub>2</sub>) for PFRK and ASK
- 2500 Nm<sup>3</sup>/t (11 % O<sub>2</sub>) for MFSK and OK,

The specific sulphur oxide flow is in the range of between 0.2 and 1.2 kg/t lime for PFRK/ASK and 0.1 and 1.0 kg/t lime for MFSK/OK.

### 2.3.3.4 Carbon oxides (CO<sub>x</sub>)

#### 2.3.3.4.1 Carbon dioxide (CO<sub>2</sub>)

Emissions of CO<sub>2</sub> are determined and reported as a greenhouse gas. Emissions of CO<sub>2</sub> from the lime industry are involved in the Emissions Trading Scheme. Regarding CO<sub>2</sub> emissions and the Emissions Trading Scheme, information can be found in Directive 2003/87/EC of the European Parliament and the Council of 13 October 2003 establishing a scheme for greenhouse gas emissions allowance trading within the Community and **subsequent amendment by Directive 2009/29/EC** [99, European Union, 2003] [191, European Union, 2009].

The basic mineralogical reaction in lime/dolime manufacturing can be expressed by:

- lime:  $\text{CaCO}_3 + \text{energy} \rightarrow \text{CaO} + \text{CO}_2 \text{ process} + \text{CO}_2 \text{ combustion}$
- dolime:  $\text{CaCO}_3 \cdot \text{MgCO}_3 + \text{energy} \rightarrow \text{CaO} \cdot \text{MgO} + 2\text{CO}_2 \text{ process} + \text{CO}_2 \text{ combustion}$

(CO<sub>2</sub> process) determined from lime/dolime production

(CO<sub>2</sub> combustion) determined from energy consumption

Quantities of process and combustion CO<sub>2</sub>, by type of kiln, are shown in Table 2.25.

Type of kiln <sup>(1)</sup>	Tonne of process CO <sub>2</sub> per tonne of lime (CaO) <sup>(2)</sup>	Tonne of process CO <sub>2</sub> per tonne of dolime (CaO.MgO) <sup>(2)</sup>	Tonne of combustion CO <sub>2</sub> per tonne of lime/dolime	Total activity CO <sub>2</sub> emissions factor
Long rotary kilns (LRK)	0.785	0.913	0.365 – 1.062	Lime 1.150 – 1.847 Dolime 1.278 – 1.975
Rotary kilns with preheater (PRK)	0.785	0.913	0.269 – 0.617	Lime 1.054 – 1.402 Dolime 1.182 – 1.530
Parallel flow regenerative kilns (PFRK)	0.785	0.913	0.202 – 0.425	Lime 0.987 – 1.210 Dolime 1.115 – 1.338
Annular shaft kilns (ASK)	0.785	0.913	0.224 – 0.465	Lime 1.009 – 1.250 Dolime 1.137 – 1.378
Mixed feed shaft kilns (MFSK)	0.785	0.913	0.224 – 0.708	Lime 1.009 – 1.493 Dolime 1.137 – 1.621
Other kilns (OK)	0.785	0.913	0.224 – 0.508	Lime 1.009 – 1.291 Dolime 1.137 – 1.419

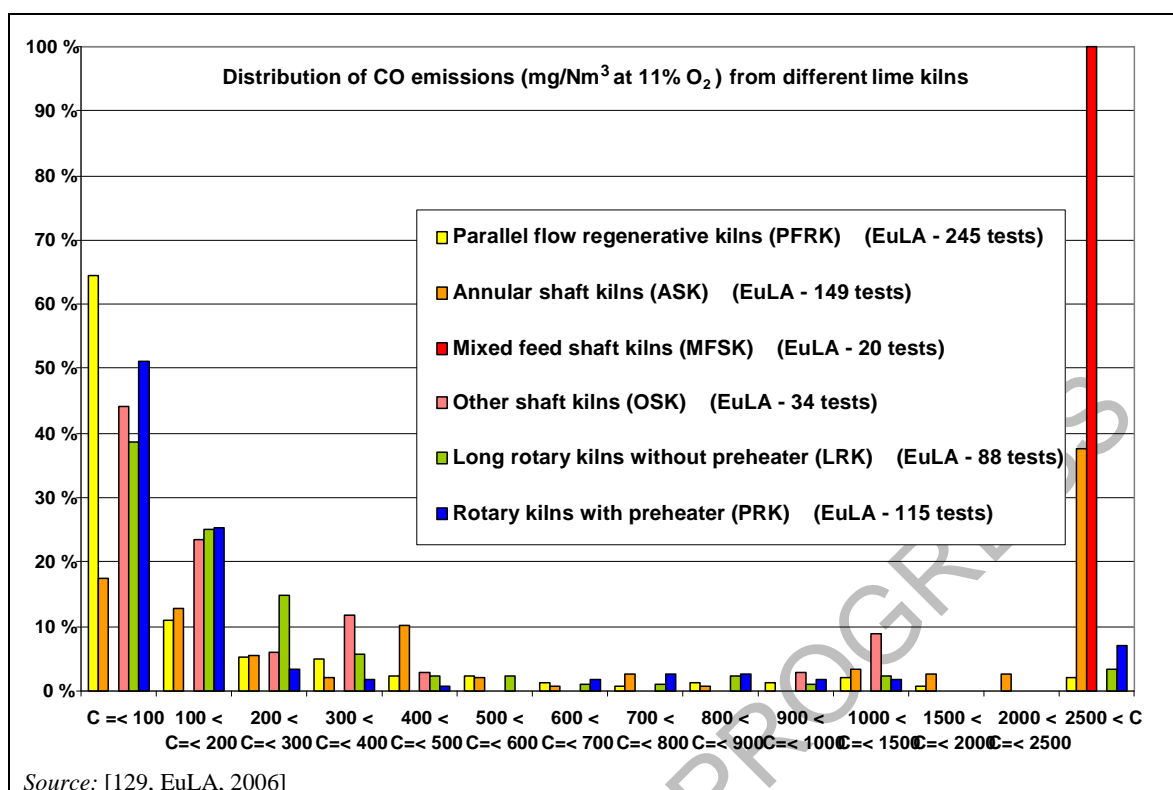
<sup>(1)</sup> The type of kiln depends on the required product quality, limestone quality and granulometry input  
<sup>(2)</sup> Process CO<sub>2</sub> emissions factor defined by UNFCCC IPCC guidelines. More information can be found in the '2006 IPCC Guidelines for National Greenhouse Gas Inventories, Volume 3, Industrial Processes and Product Use'.  
Source: [54, EuLA, 2006]

**Table 2.25: CO<sub>2</sub> emissions factors from different kiln types in the lime industry**

Until 2008, the emissions of carbon dioxide per tonne of quicklime were reduced in most countries of the EU-27, not only by replacing old kilns with more thermally efficient designs, but also by an improvement in the use of energy (for example, through better process control) and by increasing the productivity (e.g. by reducing the amount of waste dust produced).

#### 2.3.3.4.2 Carbon monoxide (CO)

Typical CO emissions from lime plants are shown in Figure 2.39. CO emissions from lime kilns range from between less than 100 up to 2500 mg/Nm<sup>3</sup> depending on the kiln type and the type of fuel used. Around 50 % of the spot test results show CO emission values of less than 100 mg/Nm<sup>3</sup>.



**Figure 2.39:** CO emissions occurring from different types of lime kilns in the EU-27

Experiments carried out at lime kilns show that, by using thermal oxidation, CO concentrations of 2 vol-% can safely be managed. However, the CO emissions concentration in the clean gas is always  $<100 \text{ mg/Nm}^3$  [142, EnvNGO/Tebert, 2007].

The concentration of CO is measured at the bottom of the stack. When it enters the atmosphere, it will be quickly oxidised to  $\text{CO}_2$  and dispersed.

When resulting from incomplete combustion, carbon monoxide (CO) emissions generally represent a loss of efficiency. Therefore, the operator tends to limit the CO emissions from their kilns.

#### *Rotary kilns*

CO emissions are continuously monitored at the extremity of the tube, on the exhaust gases side. CO emissions are linked to the targeted quality of lime, when sulphur is present in the limestone and/or fuel.

CO emissions for these kilns range usually from 100 to  $400 \text{ mg/Nm}^3$  depending on the type of fuel used. Based on a specific flue-gas flow of:

- $5000 \text{ Nm}^3/\text{t}$  at 11 %  $\text{O}_2$  for LRK
- $4000 \text{ Nm}^3/\text{t}$  at 11 %  $\text{O}_2$  for PRK,

The specific carbon monoxide flow is in the range of between 0.5 and 2.0 kg/t lime for LRK and 0.4 and 1.6 kg/t lime for PRK.

*Shaft kilns (other kilns (OK), mixed feed (MFSK), annular (ASK), and parallel flow regenerative (PFRK))*

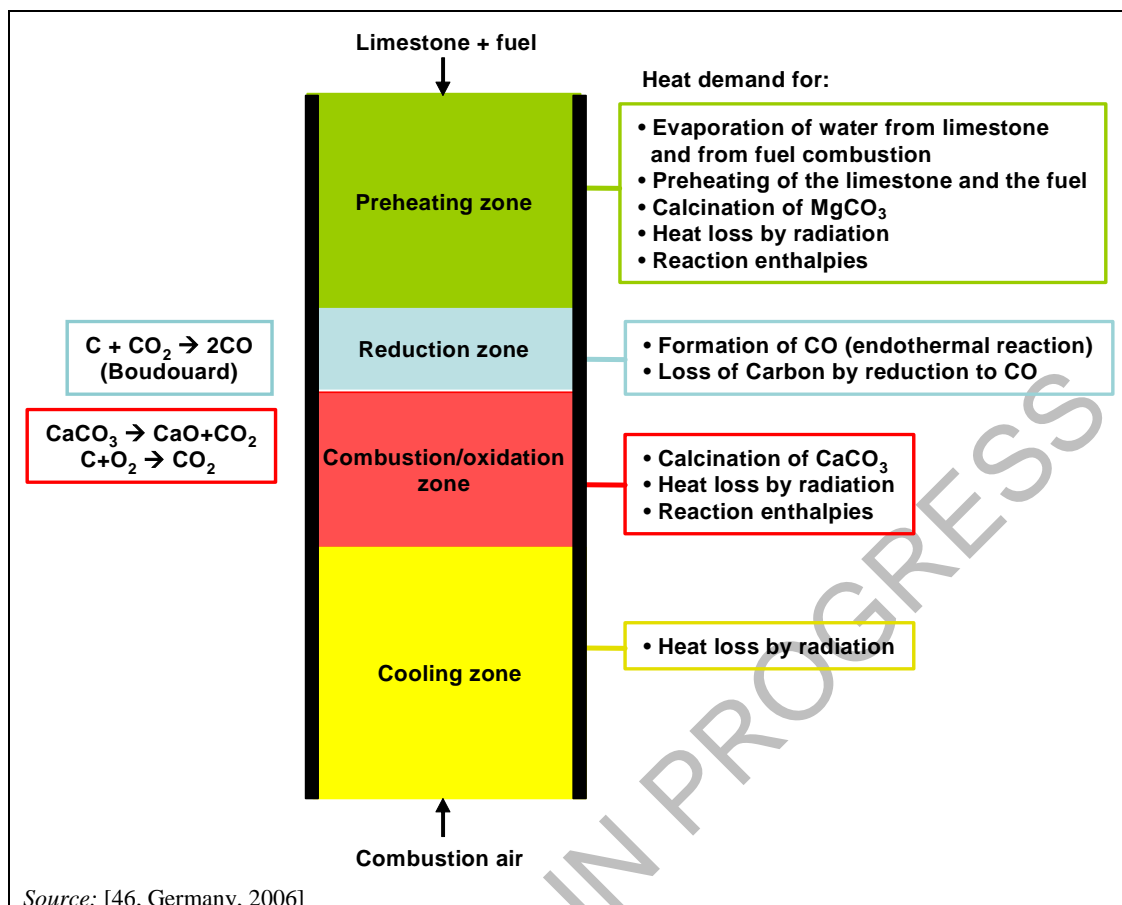
Annular shaft kilns (ASK) are operated, because of their basic design, with an excess of oxygen in the lower burner level and under stoichiometric conditions in the upper burner level. Therefore, the typical emissions range from 100 to 2500 mg/Nm<sup>3</sup>. Based on the specific flue-gas flow of 3000 Nm<sup>3</sup>/t (11 % O<sub>2</sub>), the specific carbon monoxide flow is in the range of between 0.3 and 7.5 kg/t lime.

For other shaft kilns (OSK), the quantity of measurements does not allow consistent ranges for CO emissions to be quoted.

For mixed feed shaft kilns, it has to be noted that – in contrast to other combustion processes – the CO emission level of lime kilns does not automatically indicate incomplete combustion. The operating conditions of lime kilns are always determined by product requirements, i.e. by requested properties of the burned lime. As higher CO emissions correspond to a higher energy consumption of the kiln (+1 % CO in the waste gas is equal to an additional energy consumption of about 200 kJ/kg lime), lime kilns are usually operated in a way that keeps CO emissions as low as possible, depending on the individual products. In the German lime industry in general, the CO level in the waste gas is kept below 3 % by process optimisation techniques. In order to reduce CO emissions, process optimisation is the only choice [46, Germany, 2006]. Furthermore for mixed feed shaft kilns, CO emissions in the range of between 1 to 6 % can be observed when producing certain products. In these cases, controlled levels of carbon monoxide are necessary to produce the required product quality. However, some lime applications require hard burned lime, which is mainly produced in mixed feed shaft kilns. The CO emissions of mixed feed shaft kilns are determined by on the so-called Boudouard reaction as shown in Figure 2.40.

For parallel flow regenerative kilns (PFRK), very short CO peaks appear at the beginning of the cycles. At the end of the cycle, fuel injection is stopped, and before ‘reversal’, only air is injected for a time, to ensure all the fuel is burned. Experience shows that, despite this, a small quantity of fuel may remain under the lances. After reversal, it continues burning in unfavourable conditions, producing a ‘peak’ of CO.

CO emissions for these kilns range usually from 100 to 400 mg/Nm<sup>3</sup> depending on the type of fuel used. Based on the specific flue-gas flow of 3000 Nm<sup>3</sup>/t (11 % O<sub>2</sub>) the specific carbon monoxide flow is in the range of between 0.3 and 1.2 kg/t lime.



Source: [46, Germany, 2006]

Figure 2.40: Chemical reactions and energy use in a mixed feed shaft kiln (Boudouard reaction)

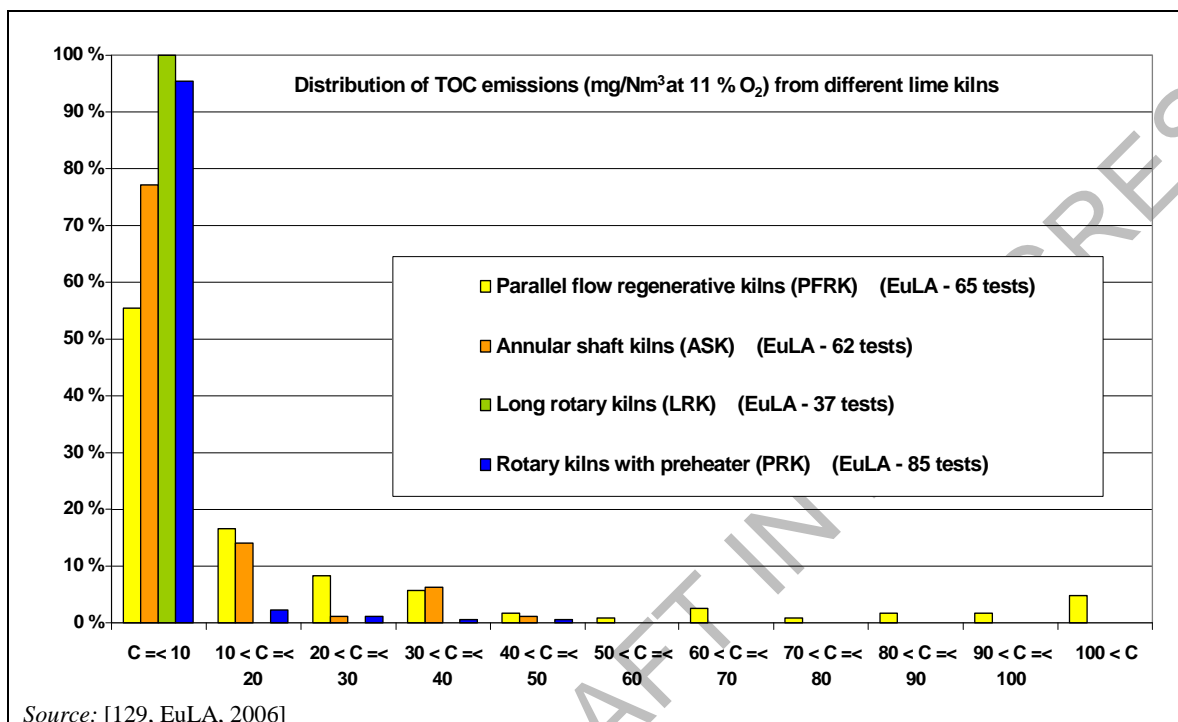
The Boudouard reaction is mainly determined by the temperature profile of the fuel in the oxygen-free atmosphere. Other relevant factors are the grain size, the reactivity of the fuel, the homogeneity of the feedstock, the air velocity and the initial  $CO_2$  content. The CO generation rate rises with higher temperatures in the reduction zone. Therefore, prevention of CO emissions arising from mixed feed shaft kilns may be difficult and, to some extent, impossible [46, Germany, 2006].

#### Hydraulic lime production

Some limestone contains carbon, which can also lead to higher CO emissions from the lime burning process, such as in the case of natural hydraulic lime plants (see Section 2.2.2) using OSK where the limestone contains 65 – 90 %  $CaCO_3$  and  $MgCO_3$ . The purity of this raw material is different from raw materials which are used for the production of other types of lime. During periodic measurements (twice a year) between 2003 and 2006, CO emission values in a range of between 5904 to 12560  $mg/Nm^3$  (spot measurement, 8 %  $O_2$ , standard state) were measured (respectively 4541 – 9555  $mg/Nm^3$  at 11 %  $O_2$ ) [128, Portugal, 2007].

### 2.3.3.5 Organic compounds/total organic carbon (TOC)

VOC emissions are typically measured as total organic carbon (TOC). Specific analysis has shown that part of the TOC is mainly due to methane, however, benzene was also found as a measurement result. From mixed feed shaft kilns, 80 – 90 % methane and 2 % benzene are observed from emissions [46, Germany, 2006] [54, EuLA, 2006]. Typical emissions of organic compounds measured as total organic carbon (TOC) from different types of lime kilns (LRK, PFRK, ASK) are shown in Figure 2.41.



**Figure 2.41:** TOC emissions occurring from different types of lime kilns in the EU-27

Emissions of VOCs are often related to emissions of CO, resulting from incomplete fuel combustion. Because the operator tends to limit the CO emissions of the kilns, the VOCs emissions remain generally low. In a very limited number of cases where the raw material, limestone contains organic matter of up to 0.1 %, volatile organic compounds can be emitted continuously.

For all kiln types except parallel flow regenerative kilns (PFRK) and mixed feed shaft kilns (MFSK), these emissions occur for short periods during start-up, or upset conditions thus leading to emissions of below 10 mg/Nm<sup>3</sup> (eqC). For PFRK, the process entails cyclic changes of combustion conditions every 10 to 12 minutes. Therefore, the levels of VOC emissions are slightly above the ones observed for other types of kilns. With older MFSKs, higher TOC emissions can occur because of the special process conditions which exist in the upper part of the kiln (reductive areas).

#### *Hydraulic lime production*

The emissions situation in the case of natural hydraulic lime production is different. The purity of the raw material used is different from raw material which is used for the production of other types of lime. The high content of organic matter in the raw material is due to the fossilisation of organisms within the material instead of converting them into carbon dioxide and water over the centuries. The organic material content (expressed in TOC) is in a typical range of between



0.8 – 5 %. A case study from 2005 shows that, where the raw material content of organic matter was in a range of between 2.8 and 5 %, the content of TOC in the calcined product was in a range of between 0.7 and 1.2 %. In a limited number of cases where the limestone contains a significant amount of organic matter, volatile organic carbon (expressed as TOC) may be emitted continuously. During periodic measurements (twice a year) between 2003 and 2006, TOC emission values in a range of between 593 to 2169 mg/Nm<sup>3</sup> (spot measurement, 8 % O<sub>2</sub>, standard state) have been measured (respectively 456 – 1668 mg/Nm<sup>3</sup> at 11 % O<sub>2</sub>) [127, Portugal, 2007].

### 2.3.3.6 Polychlorinated dibenzo-p-dioxins (PCDD) and polychlorinated dibenzofurans (PCDF)

Raw materials or fuels that contain chlorides may potentially cause the formation of PCDD/F in any of the process zones where the temperatures range from 300 to 450 °C.

Data reported in the document ‘Identification of Relevant Industrial Sources of Dioxins and Furans in Europe’ indicate that lime production plants are of minor significance for the total PCDD/F emissions in Europe [31, LUA NRW, 1997].

The lime industry has performed measurements, most of them for internal purposes, in order to get a better overview of the PCDD/F situation. Data available in 2006 were quite representative of lime production in the EU-27, as shown in Table 2.26.

Kiln type	Average emissions PCDD/F (ng I-TEQ/Nm <sup>3</sup> (11% O <sub>2</sub> ))	Number of kilns monitored	Total number of kilns in the EU-27	Percentage (%)
Long rotary kilns (LRK)	0.0638	11	25	44
Rotary kilns with preheater (PRK)	0.0698	15	20	75
Parallel flow regenerative kilns (PFRK)	0.0198	45	149	30
Annular shaft kilns (ASK)	0.0155	40	77	52
Mixed feed shaft kilns (MFSK)	0.0532	25	115	22
Other kilns (OK)	0.0050	1	158	0.6

*Source:* [54, EuLA, 2006]

**Table 2.26:** Average PCDD/F emissions for different types of kilns in the EU-27

### 2.3.3.7 Hydrogen chloride and hydrogen fluoride (HCl and HF)

Examples of typical HCl and HF emissions from various types of lime kilns are shown in Table 2.27.

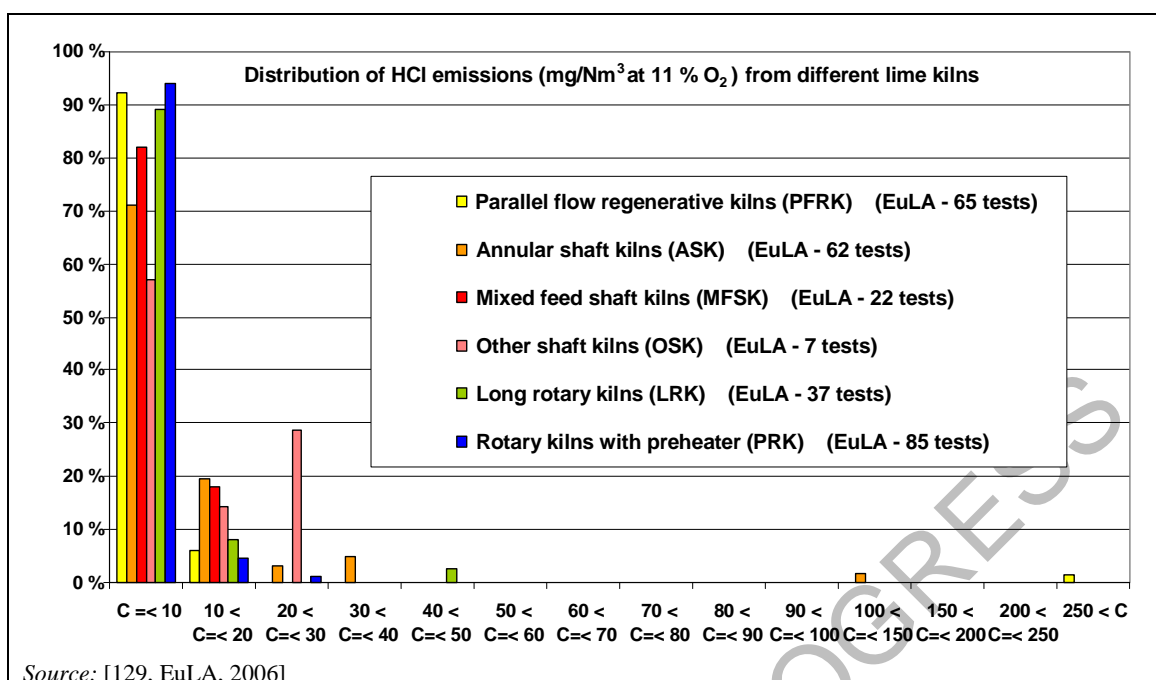
Kiln type	mg HCl/Nm <sup>3</sup> <sup>(1)</sup>	mg HF/Nm <sup>3</sup> <sup>(1)</sup>
<b>Quicklime (soft to hard burned)</b>		
Long rotary kilns (LRK)	<5 – <50	<1
Rotary kilns with preheater (PRK) <sup>(2)</sup>	<5 – <20	<1
Parallel flow regenerative kilns (PFRK)	<10	<1
Annular shaft kilns (ASK)	<20 – <40	<2
Mixed feed shaft kilns (MFSK)	<15 – <20	<1
Other kilns (OK)	<10	<1
<b>Dolime (soft burned to sintered)</b>		
Long rotary kilns (LRK)	<150	<1
Rotary kilns with preheater (PRK)	<30	<1
Mixed feed shaft kilns (MFSK)	<20	<1
<b>Use of waste</b>		
Different kiln types	10 <sup>(3)</sup>	1 <sup>(3)</sup>
	60 <sup>(4)</sup>	4 <sup>(4)</sup>
<sup>(1)</sup> Emissions concentrations are measured as half hourly average values and related to 10 % O <sub>2</sub> to make values comparable <sup>(2)</sup> Grate preheater rotary kiln <sup>(3)</sup> Daily average value <sup>(4)</sup> Half hourly average value <i>Source: [46, Germany, 2006], [168, TWG CLM, 2007]</i>		

**Table 2.27: Typical HCl and HF emissions from various types of lime kilns in the EU-27**

The behaviour of HCl in lime kilns is very similar to that of SO<sub>2</sub>. Thus, in the majority of lime burning operations, most of the chlorine which is present in the raw material (limestone) and the fuel is captured by the quicklime. The efficient contact between the kiln gases and the lime/dolime usually ensures efficient absorption of HCl. This is especially the case for vertical kilns where there is an efficient contact between the kiln gases and the lime/dolime. However, the HCl emissions from shaft kilns are mainly dependent upon the content of chlorine compounds in the limestone. HCl emissions tend to be higher when dry limestone is burned. In some cases, HCl emissions may be reduced by injecting water into the flue-gas.

As the chlorine content is higher in dolomite (100 to about 1000 ppm) than in limestone (10 to 150 ppm), the associated HCl emissions are, in general, higher when dolime is produced. Thus, for rotary kilns producing dolime, it was observed that these emissions can exceed an emission value of 10 mg/Nm<sup>3</sup> (threshold of the **Directive for waste incineration plants**), even if no chlorinated fuel was used.

The distribution of typical emissions of HCl from different types of lime kilns (LRK, PFRK, ASK) are shown in Figure 2.42.



**Figure 2.42:** HCl emissions from different lime kilns in the EU-27

In some cases, by using wastes as fuels and/or raw materials, emission values of 10 mg/Nm<sup>3</sup> for HCl and 1.0 mg/Nm<sup>3</sup> for HF are set as daily average values (10 % oxygen content). These emission levels also have to be kept during spot or periodic measurements [46, Germany, 2006], [168, TWG CLM, 2007].

### 2.3.3.8 Hydrogen sulphide (H<sub>2</sub>S)

Because of the strong reducing conditions occurring in the upper part of mix feed shaft kilns, H<sub>2</sub>S emissions arise only from this kiln type. Emissions of up to 20 mg/Nm<sup>3</sup> were observed.

However, no link was found between the sulphur content in the kiln feed, such as stone and fuel, and the H<sub>2</sub>S emissions. This is due to the fact that parts of sulphur (in the kiln feed) are present in reduced form, e.g. pyrite, organic bound sulphur or elemental sulphur, when the remaining part is in oxidised forms, e.g. sulphate. The proportion of both is usually not known as the typical sulphur analysis indicates, only the total of both. However, during the chemical processes, which take place at the top of the mix feed shaft kiln, only the reduced or elemental forms of the sulphur lead to the formation of H<sub>2</sub>S [46, Germany, 2006], [54, EuLA, 2006].

### 2.3.3.9 Metals

Large quantities of data are now available for the following metals: antimony, arsenic, cadmium, chromium, cobalt, copper, lead, manganese, mercury, nickel, selenium, tellurium, thallium, vanadium and zinc. Furthermore, from the use of waste materials, emissions of metals can also arise, as shown from an example in Section 6.3.4 (see Table 6.40).

Data for the emissions of metals in the EU-27 are shown in Table 2.28. In this table, the results (C) refer to an oxygen content of 11 % and they are the compilation of metals in vapour form and particulate form. In cases when the measured concentration was less than the detection limit, it was assumed that the result is equal to the detection limit. As a conclusion for most of these measurements, the emissions are below the analytical detection limits even in the case of using waste fuels. Therefore, emission values are within a range of 0.01 – 0.1 mg/Nm<sup>3</sup>. For lead

and zinc, in some specific cases with higher dust emissions, values of up to 0.40 mg/Nm<sup>3</sup> can be observed.

Detailed figures regarding the distribution of different types of metal concentrations in the flue-gas of lime kilns in the EU-27 are shown in Section 6.3.1 [56, EuLA, 2006].

WORKING DRAFT IN PROGRESS

Metals	Results of metal emissions (C) in mg/Nm <sup>3</sup>												
	C≤0.010	0.010<C<0.020	0.020<C<0.030	0.030<C<0.040	0.040<C<0.050	0.050<C<0.060	0.060<C<0.070	0.070<C<0.080	0.080<C<0.090	0.090<C<0.100	0.100<C		
Arsenic (As)													
All types of fuels, kilns, dedusting systems	283	7	1	1	0	0	1	1	1	1	2		
Cadmium (Cd)													
All types of fuels, kilns, dedusting systems	279	30	9	8	0	1	0	0	0	0	2		
Cobalt (Co)													
All types of fuels, kilns, dedusting systems	248	15	1	0	3	1	0	0	0	0	0		
Chromium (Cr)													
All types of fuels, kilns, dedusting systems	242	30	13	13	3	1	0	0	0	0	2		
Copper (Cu)													
All types of fuels, kilns, dedusting systems	254	20	6	4	1	5	7	1	1	0	3		
Mercury (Hg)													
All types of fuels, kilns, dedusting systems	237	27	10	6	3	0	0	0	0	0	3		
Manganese (Mn)													
All types of fuels, kilns, dedusting systems	206	25	11	6	5	3	3	2	1	0	13		
Nickel (Ni)													
All types of fuels, kilns, dedusting systems	230	36	19	14	4	0	4	0	1	0	5		
Lead (Pb)													
All types of fuels, kilns, dedusting systems	292	21	9	1	2	1	1	0	0	0	3		
Antimony (Sb)													
All types of fuels, kilns, dedusting systems	255	6	0	1	0	0	0	0	0	0	0		
Selenium (Se)													
All types of fuels, kilns, dedusting systems	139	3	5	0	0	1	0	0	0	0	0		
Tin (Sn)													
All types of fuels, kilns, dedusting systems	145	33	5	5	2	4	2	0	0	2	9		
Tellurium (Te)													
All types of fuels, kilns, dedusting systems	124	6	2	0	0	0	0	0	0	0	1		
Thallium (Tl)													
All types of fuels, kilns, dedusting systems	159	40	18	10	1	1	0	0	0	1	0		
Vanadium (V)													
All types of fuels, kilns, dedusting systems	210	19	2	1	0	1	0	0	0	0	11		
					Results of metal emissions (C) in mg/Nm <sup>3</sup>								
	C≤0.1	0.1<C≤0.2	0.2<C≤0.3	0.3<C≤0.4	0.4<C≤0.5	0.5<C≤0.6	0.6<C≤0.7	0.7<C≤0.8	0.8<C≤0.9	0.9<C≤1	1<C		
Zinc (Zn)													
All types of fuels, kilns, dedusting systems	184	14	11	5	1	3	1	0	2	0	9		

Table 2.28: Number of plants achieving different metal emissions in the EU-27

### 2.3.3.10 Impact on emissions behaviour by using waste materials

#### 2.3.3.10.1 Emissions examples for the use of waste oil

A German example plant shows typical analysis results for emissions occurring from a shaft kiln using waste oil as fuel. This shaft kiln is equipped with a fabric filter. Within the 10 combustion chambers of an annular shaft kiln, typical temperatures range from 1140 to 1300 °C. The incinerated waste oil is delivered by a special waste oil collecting and blending facility. Before feeding the waste oil to the burner, it passes through a filtration sieve with a mesh size of 200 µm. The quality of the waste oil (calorific value approx. 0.030 – 0.039 GJ/kg and water content is approx. 4 – 13 % by weight) incinerated in the annular shaft kiln is shown in Table 2.29. This table shows typical analysis results from 2002.

Pollutant	Unit	Typical content of pollutants in waste oil after filtration (200 µm) <sup>(1)</sup>
Sulphur	% by weight	0.34 – 0.55
Total chlorine	% by weight	0.03 – 0.04
Hg	mg/kg	≤0.05
Cd	mg/kg	0.2 – 0.3
Tl	mg/kg	<0.5
<b>Metals</b>		
Σ Sb, As, Pb, Cr, Co, Cu, Ni, Mn, V, Sn	mg/kg	42 – 244
Σ 6 PCB 28, 52, 101, 153, 138, 180	mg/kg	<1
<sup>(1)</sup> Typical analysis results from 2002 Source: [46, Germany, 2006]		

**Table 2.29: Typical analysis results from the quality of waste oil used in German shaft kilns**

Table 2.30 shows German results of individual emissions measurements from 2002. Waste oil was the only fuel used during the measurements.

Parameter	Unit	Range of individual half hourly measurements
Dust	mg/Nm <sup>3</sup>	1 – 11
TOC/VOC	mg/Nm <sup>3</sup>	<4
CO	g/Nm <sup>3</sup>	0.06 – 1.2
NO <sub>x</sub>	mg/Nm <sup>3</sup>	110 – 240
SO <sub>2</sub>	mg/Nm <sup>3</sup>	1 – 13
HF	mg/Nm <sup>3</sup>	<0.2
HCl	mg/Nm <sup>3</sup>	11 – 19
PCDD/F	ng I-TEQ/Nm <sup>3</sup>	<0.004 <sup>(1)</sup>
Heavy metals		
Σ Cd, Tl	mg/Nm <sup>3</sup>	<0.01
Hg	mg/Nm <sup>3</sup>	<0.01
Σ Sb, As, Pb, Cr, Co, Cu, Ni, Mn, V, Sn	mg/Nm <sup>3</sup>	<0.04
Oxygen content 10 %, 273.15 K, 101.3 kPa, dry gas <sup>(1)</sup> For PCDD/F, the sampling period is 6 hours Source: [46, Germany, 2006], [168, TWG CLM, 2007]		

**Table 2.30: Individual emissions measurements from a German shaft kiln using waste oil**

Investigations showed that emissions of metals are very low, regardless of kiln type and incinerated fuel. Measurements from all types of kilns have shown typical values for cadmium (Cd) within a range of  $<0.001 - 0.05 \text{ mg/Nm}^3$ . For the total of the metals arsenic (As), lead (Pb), chromium (Cr), copper (Cu), nickel (Ni), selenium (Se) and tellurium (Te), typical emission levels from shaft kilns within a range of  $0.01 - 0.04 \text{ mg/Nm}^3$  were observed. At rotary kilns, emissions of the metals arsenic (As), lead (Pb), chromium (Cr), copper (Cu), nickel (Ni), selenium (Se) and tellurium (Te) were higher in some cases, up to  $0.16 \text{ mg/Nm}^3$ . Mercury emissions from all types of kilns in general were  $<0.05 \text{ mg/Nm}^3$ . Special attention has to be paid to the possible contamination of waste fuels used with mercury (e.g. waste wood). Because of the volatility of mercury, relevant higher mercury emissions may occur. Therefore, the mercury input via waste fuels has to be limited.

For the use of waste, the measured emissions for mercury were observed to be below  $0.03 \text{ mg/Nm}^3$  measured as a daily average value, or  $0.05 \text{ mg/Nm}^3$  measured as a half hourly average value. For the total of cadmium and thallium, the measured emissions were observed to be below  $0.05 \text{ mg/Nm}^3$  measured as a half hourly average value, and for the sum of arsenic, cobalt, chromium, copper, manganese, lead, antimony, tin and vanadium, the measured emissions were observed to be below  $0.5 \text{ mg/Nm}^3$  measured as a half hourly average value (oxygen content 10 %) [46, Germany, 2006].

#### 2.3.3.10.2 Examples of emissions from the use of solid waste in rotary kilns

In four rotary kilns of an example plant in Germany, solid waste is used. The types of solid waste materials selected and used depend on the technical requirements of the burning process and the product quality. As an example, the quality control of these solid waste materials is described in Section 6.3.4. All rotary kilns are equipped with emissions reduction techniques, e.g. cyclones, an ESP for dust emissions reduction and the SNCR technique for  $\text{NO}_x$  emissions reduction.

Continuous measurements for the following emissions and reference factors are taken from the kiln stacks:

- dust (incl.  $\text{PM}_{10}$ )
- nitrogen oxides ( $\text{NO}_x$ )
- sulphur oxides ( $\text{SO}_2$ ) (started 2007)
- flue-gas volume flow
- flue-gas humidity
- flue-gas pressure
- flue-gas temperature
- oxygen content.

The measuring instruments and analysing units comply with DIN/ISO 14181. The measured values are recorded and transferred online to the monitoring authority. Table 2.31 shows continuous measurements of dust and  $\text{NO}_x$  recorded in 2006. The split of the measurement periods is due to changes in the national legislation. Until the end of 2006,  $\text{SO}_x$  was measured periodically and continuous measurements for  $\text{SO}_x$  started at the beginning of 2007.

Parameter	Unit	Emission value (yearly average)
<b>January to October 2006</b>		
Dust	mg/Nm <sup>3</sup>	6.1
NO <sub>x</sub> <sup>(1)</sup>	mg/Nm <sup>3</sup>	376
NO <sub>x</sub> <sup>(2)</sup>	mg/Nm <sup>3</sup>	737
<b>November to December 2006</b>		
Dust	mg/Nm <sup>3</sup>	4.1
NO <sub>x</sub> <sup>(3)</sup>	mg/Nm <sup>3</sup>	366
<sup>(1)</sup> Soft burned lime production <sup>(2)</sup> Middle and hard burned lime production <sup>(3)</sup> Soft, middle and hard burned lime production <i>Source: [156, Germany, 2007, 164, Rheinkalk, 2007]</i>		

**Table 2.31: Continuous emissions measurements taken in 2006 from a German rotary kiln using solid fuels**

Furthermore related to national legislation, besides continuous measurements different emissions parameters are also measured periodically. Table 2.32 shows individual emissions measurements (daily average values).

Parameter	Unit	Emission values (daily average values)		
		First day	Second day	Third day
Total C (organic substances)	mg/Nm <sup>3</sup>	1.7	1.7	0.2
HCl	mg/Nm <sup>3</sup>	2.0	1.2	0.9
HF	mg/Nm <sup>3</sup>	<0.1	<0.2	<0.2
SO <sub>2</sub>	mg/Nm <sup>3</sup>	8.9	2.5	5.2
Hg	mg/Nm <sup>3</sup>	0.006	0.005	0.004
∑ Cd, Tl and components	mg/Nm <sup>3</sup>	0.003	0.007	0.005
∑ Metals and compounds	mg/Nm <sup>3</sup>	<0.009	<0.066	<0.049
Be	mg/Nm <sup>3</sup>	<0.0001	<0.0001	<0.0001
PCDD/F	ng/Nm <sup>3</sup>	0.072	0.044	0.025
Standard state, dry gas, 10.25 % O <sub>2</sub> <i>Source: [164, Rheinkalk, 2007]</i>				

**Table 2.32: Periodical individual emissions measurements taken in 2006 from a German rotary kiln using solid fuels**

### 2.3.4 Process losses/waste

The calcination of limestone can produce the by-product lime with particulate sizes and decarbonation levels which do not always correspond to the market requirements. This by-product can be collected directly from the kiln outlet during start-up and shutdown procedures or by the screening or dedusting of the flue-gas. This by-product accounts for 1 to 5 % of the total yearly production. Small quantities of partially calcined material are produced when the kiln is started up from cold, and during shutdown. Such events may occur at frequencies ranging from once every 6 months to once every 10 years.

The separated solid fraction from limestone washing, for example, natural impurities such as silica, clay and ultrafine particles, can be utilised and re-used:

- for recultivation or covering of contaminated (e.g. acid) grounds
- as raw material in the cement industry or
- for soil improvement in agriculture.



The dust collected from fabric filters can be used in different kinds of commercial products [46, Germany, 2006]

### 2.3.5 Water use and purification

The raw materials from the quarry may contain small amounts of clay and sand. In this case, the limestone is washed with water before entering the kiln. The water demand for limestone washing is 0.5 to 2 m<sup>3</sup> per tonne of raw material, depending on the nature and the amount of impurities. After being used, the washing water contains 50 to 200 ml suspended solids per litre, corresponding to a solids content of 5 to 20 g/l. In general, the washing water is not loaded with any other pollutants.

The water used for limestone washing is usually taken from surface waters or from lowering of the groundwater during excavation. Other common sources for washing water are rainfall and wells.

The purified water from both systems is re-used in the washing process. The water recycling rate is about 85 %; only 15 % constitutes process losses and needs to be replaced by fresh water.

Treatment in the thickener and mechanical dehydration generate press cakes with a residual moisture content of 10 to 20 % [46, Germany, 2006].

### 2.3.6 Noise

Noise emissions occur throughout the whole lime manufacturing process, from extraction and preparing the raw materials via the lime production process and material storage up to dispatch as well as shipping the final products. For example, during the lime production process, charging lumps of limestone into lime kilns can result in noise and/or vibration at levels which require abatement. However, sources of noise emissions can particularly originate from:

- heavy machinery
- chutes and hoppers
- any operations involving fracture, crushing, milling and screening of lime
- exhaust fans
- blowers
- duct vibration.

Plants are required to comply with noise reduction standards in compliance with national legislation.

### 2.3.7 Odours

Emissions of odour may occur in lime plants using mixed feed shaft kilns because of the hydrogen sulphide (H<sub>2</sub>S) emissions produced. By using a fuel mix of 30 % coke and 70 % anthracite, H<sub>2</sub>S emissions ranges of between 6 and 9.5 mg/Nm<sup>3</sup> were reported. With exclusive use of anthracite, reduced H<sub>2</sub>S emissions of between not detectable and <1.6 mg/Nm<sup>3</sup> were reported.

Furthermore, waste materials used as raw materials or fuels may lead to odour emissions, especially during different process steps such as preparation and storage.

### 2.3.8 Monitoring

According to the European Lime Association, for vertical lime kilns, experience shows that the process conditions are generally stable. The level of emissions can only change if the chemical composition of the limestone and/or the fuel and the process conditions required to ensure a certain product quality, are modified.

Additional useful information regarding monitoring can be found in the Reference Document on the General Principles of Monitoring [151, European Commission, 2003]

#### 2.3.8.1 Continuous measurements

Emissions measurements do indeed confirm the stability of the emissions. To control the kiln firing process, several process parameters are continuously monitored, demonstrating the process stability, e.g.

- temperature
- O<sub>2</sub> content
- airflow
- pressure.

Moreover, some of these process parameters are representative and therefore linked to the emissions parameters, e.g. intensity of the ESP and dust emissions. Additionally, continuously taking measurements may be appropriate and have been reported in some particular cases for the following parameters:

- NO<sub>x</sub>
- SO<sub>2</sub>
- dust
- CO.

However, if waste materials are used as fuels, continuous emissions monitoring according to the provision of **Annex VI to the Directive 2010/75/EU** is normally required, such as for emissions of dust and NO<sub>x</sub>, and – in some cases – SO<sub>2</sub> and VOC/TOC. When co-incinerating waste, the requirements of **Chapter IV of and Annex VI to the Directive 2010/75/EU** have to be met.

It could also be appropriate to monitor the emissions of large rotary kilns due to the variability of some of their process parameters. Furthermore, depending on the fuels used, the process conditions and the relevance of the emissions, it may be necessary to carry out additional measurements [46, Germany, 2006], [54, EuLA, 2006].

#### 2.3.8.2 Periodic measurements

Periodic measurements are carried out for the following pollutants, unless monitored continuously:

- dust
- sulphur dioxide (SO<sub>2</sub>)
- nitrogen oxide (NO<sub>x</sub>).

Depending on the input fuels especially in the case of waste used, process conditions and the relevance of the emissions, additional measurements are carried out for the following pollutants:

- carbon oxide (CO)
- total organic carbon (TOC)
- hydrogen chloride (HCl)
- hydrogen fluoride (HF)
- heavy metals
- polychlorinated dibenzo-p-dioxins (PCDD) and polychlorinated dibenzofurans (PCDF).

The monitoring of benzo-a-pyrene (C<sub>20</sub>H<sub>12</sub>), (category 2A, probably carcinogenic for humans according to IARC classification) is carried out in some cases.

WORKING DRAFT IN PROGRESS

## 2.4 Techniques to consider in the determination of BAT

**\*\*NOTE to Article 13 Forum members: Old introductory text have been deleted and replaced with the new standard text adapted to the specificities of the CLM BREF\*\***

This section describes techniques (or combinations thereof), and associated monitoring, considered to have the potential for achieving a high level of environmental protection in the activities within the scope of this document. The techniques described will include both the technology used and the way in which the installations are designed, built, maintained, operated and decommissioned.

It covers environmental management systems, process-integrated techniques and end-of-pipe measures. Waste prevention and management, including waste minimisation and recycling procedures are also considered, as well as techniques that reduce the consumption of raw materials, water and energy by optimising use and reuse.

Annex III to the Directive lists a number of criteria for determining BAT, and the information within this chapter will address these considerations. As far as possible, the standard structure in Table 1.30 is used to outline the information on each technique, to enable a comparison of techniques and the assessment against the definition of BAT in the Directive.

This section does not necessarily provide an exhaustive list of techniques which could be applied in the sector. Other techniques may exist, or may be developed, which could be considered in the determination of BAT for an individual installation.

Type of information considered	Type of information included
Description	A brief description of the technique using, as appropriate, chemical or other equations, pictures, diagrams and flow charts
Achieved environmental benefits	The <b>main</b> potential environmental benefits to be gained through implementing the technique (including reduced consumption of energy; reduced emissions to water, air and land; raw material savings; as well as production yield increases, reduced waste, etc.).
Cross-media effects	<p>Relevant negative effects on the environment due to implementing the technique, allowing a comparison between techniques in order to assess the impact on the environment as a whole. This may include issues such as:</p> <ul style="list-style-type: none"> <li>• consumption and nature of raw materials and water</li> <li>• energy consumption and contribution to climate change</li> <li>• stratospheric ozone depletion potential</li> <li>• photochemical ozone creation potential</li> <li>• acidification resulting from emissions to air</li> <li>• presence of particulate matter in ambient air (including microparticles and metals)</li> <li>• eutrophication of land and waters resulting from emissions to air or water</li> <li>• oxygen depletion potential in water</li> <li>• persistent/toxic/bioaccumulable components (including metals)</li> <li>• generation of residues/waste</li> <li>• limitation of the ability to reuse or recycle residues/waste</li> <li>• generation of noise and/or odour</li> <li>• increased risk of accidents.</li> </ul> <p>The Reference Document on Economics and Cross-media Effects (ECM) should be taken into account.</p>
Operational data	Actual and plant-specific performance data (including emission levels, consumption levels – of raw materials, water, energy – and amounts of residues/wastes generated).

Type of information considered	Type of information included
	<p>Any other useful information on the following items:</p> <ul style="list-style-type: none"> <li>• how to design, operate, maintain, control and decommission the technique</li> <li>• emission monitoring issues related to the use of the technique</li> <li>• sensitivity and durability of the technique</li> <li>• issues regarding accident prevention.</li> </ul>
Applicability	<p>It is indicated whether the technique can be applied throughout the sector. Otherwise, the main general technical restrictions on the use of the technique within the sector are indicated. These may be:</p> <ul style="list-style-type: none"> <li>• an indication of the type of plants or processes within the sector to which the technique cannot be applied;</li> <li>• constraints to implementation in certain generic cases, considering, e.g.: <ul style="list-style-type: none"> <li>• whether it concerns a new or an existing plant, taking into account factors involved in retrofitting (e.g. space availability) and interactions with techniques already installed</li> <li>• plant size, capacity or load factor</li> <li>• quantity, type or quality of product manufactured</li> <li>• type of fuel or raw material used.</li> </ul> </li> </ul> <p>These restrictions are indicated together with the reasons for them.</p> <p>These restrictions are not meant to be a list of the possible local conditions that could affect the applicability of the technique for an individual plant</p>
Economics	<p>Information on the costs (capital/investment, operating and maintenance including details on how these costs have been calculated/estimated) and any possible savings (e.g. reduced raw material or energy consumption, waste charges, reduced payback time compared to other techniques), or revenues or other benefits including details on how these have been calculated/estimated.</p> <p>The Reference Document on Economics and Cross-media Effects (ECM) and the Reference Document on the General Principles of Monitoring (MON) are taken into account with regard to economic aspects and monitoring costs, respectively.</p>
Driving force for implementation	<p>Where applicable, specific local conditions, requirements (e.g. legislation, safety measures) or non-environmental triggers (e.g. increased yield, improved product quality, economic incentives – e.g. subsidies, tax breaks) which have driven or stimulated the implementation of the technique to date.</p>
Example plants	<p>Reference to a plant(s) where the technique has been implemented and from which information has been collected and used in writing the section. An indication of the degree to which the technique is in use in the EU or worldwide.</p>
Reference literature	<p>Literature or other reference material (e.g. books, reports, studies) that was used in writing the section and that contains more detailed information on the technique. When the reference material consists of a large number of pages, reference will be made to the relevant page(s) or section(s).</p>

**Table 2.33: Information for each technique**

### 2.4.1 Consumption of limestone

#### Description and achieved environmental benefits

The minimum consumption and a sustainable use of limestone result from maximising the yield of kiln stone from the quarry by optimising the mining (drilling and blasting) and the processing techniques and of saleable quicklime from the kiln stone. This can be achieved by using optimised kiln techniques which can operate with a wider range of limestone grain sizes, e.g. fine lime PFRK and/or rotary kilns.

#### Cross-media effects

No cross-media effects.

#### Operational data

Operational parameters for different types of lime kilns can be found in Table 2.15.

#### Applicability

Generally applicable in the lime industry but stone processing and kiln techniques are dependent on the limestone quality.

#### Economics

No data available.

#### Driving force for implementation

Finite availability of limestone.

Environmental benefit due to the extension of the lifetime of quarries (sustainability).

Legal requirements.

#### Example plants and reference literature

Lime plants in the EU-27.

[54, EuLA, 2006].

### 2.4.2 Reduction of energy consumption (energy efficiency)

#### Description and achieved environmental benefits

An energy management system for monitoring the energy use of the kilns is applicable in the lime industry.

If only the energy efficiency and the CO<sub>2</sub> emissions are considered, the vertical kilns in general and the parallel flow regenerative kilns (PFRK) in particular are the most efficient kilns. However, even if energy and CO<sub>2</sub> considerations play a fundamental role, the other specifications have to be considered before making a decision on the choice of kiln (see Sections 2.2.7 and 2.3.2) or raw material. In some cases, the specifications can create a technical advantage to rotary kilns, especially with upgraded rotary kilns.

In most cases, new kilns replace old kilns, but some existing kilns have been modified to reduce fuel energy use. Such modifications range from minor modifications to major changes in the configuration of the kiln, depending on the technical feasibility, cost and actual need, as for example:

- the installation of heat exchangers for long rotary kilns to recover surplus heat from flue-gases or to permit the use of a wider range of fuels
- the use of surplus heat from rotary kilns to dry limestone for other processes such as limestone milling
- in some cases, where shaft kilns have ceased to be economically viable, it has been feasible to convert them to modern designs, for example by converting a simple shaft kiln to the annular shaft design or by linking a pair of shaft kilns to create a parallel flow

regenerative kiln. Conversion extends the life of expensive items of equipment, such as the kiln structure, the stone feed system and the lime handling/storage plant

- in exceptional cases, it may be economic to shorten long rotary kilns and to fit a preheater, thus reducing fuel use
- electrical energy use can be minimised through the utilisation of energy efficient equipment.

The energy efficient measure/techniques listed here have a positive effect on energy use:

- process control, e.g. excess of air combustion, fuel flowrate
- maintenance of the equipment, e.g. air tightness, erosion of refractory
- optimised grain size of stone.

Furthermore, Table 2.34 lists options for energy efficiency improvement in lime kilns sorted by kiln system components.

Kiln system component	Description	LRK	PRK	PFRK	ASK	MFSK, OK
Combustion system	Highly efficient and flexible burner technique to adapt the temperature profile to the product requirement	X	X	-	-	-
Combustion system	Online combustion monitoring and excess air reduction	X	X	-	-	-
Combustion system	Combustion control through flue-gas analysis	-	-	X	X	X
Combustion system	Highly flexible combustion system including possible fuel blends with waste fuels	X	X	X	X	X
Cooler	Efficient cooler with homogeneous air distribution and product discharge to minimise the quantity of cooling air which is required	X	X	X	X	X
Cooler	Reliable cooler level measurement device	X	X	-	-	-
Flue-gas circuit	Heat recovery system	X	-	-	-	-
Input control	Regular fuel and stone sampling and analysis as well as adaptation of the process accordingly	X	X	X	X	X
Input control	Stone re-screen before kiln feed to control stone gradation	X	X	X	X	X
Input control	Reliable weighing/metering devices to control fuel, stone and air flow rate	X	X	X	X	X
Kiln design <sup>(1)</sup>	Optimised length:diameter ratio	X	X	X	X	X
Kiln itself	Refractory internals inside the rotating part to promote heat exchange and minimise product segregation	X	X	-	-	-
Kiln itself	Efficient insulating lining to minimise the shell heat losses	X	X	X	X	X
Kiln itself	Air in-leakage reduction by installing seals at kiln hood and kiln feed	X	X	-	-	-
Kiln itself	Channel cleaning on a regular basis	-	-	X	X	X
Kiln and preheater	Air in-leakage reduction to control excess air	-	-	X	X	X
Kiln operation	Automatic control loops for hood draft, excess air, fuel rate, tonne/kiln revolution, adjustment, etc.	X	X	-	-	-
Kiln operation	PLC and supervision system with key parameter trends	X	X	X	X	X
Kiln operation	Uniform operating conditions	X	X	X	X	X
Kiln operation	Analysis of shutdown causes and repairs	X	X	X	X	X
Preheater	Optimise pressure drop versus heat exchange	-	X	-	-	-
Quality follow up	Regular lime sampling and analysis as well as kiln adjustment	X	X	X	X	X

<sup>(1)</sup> Only applicable to new kilns

Source: [168, TWG CLM, 2007], [177, EULA, 2008]

**Table 2.34: Options for energy efficiency improvement in lime kilns**

### **Cross-media effects**

As the access to natural resources becomes more difficult, a balance has been found on a local level between the optimal use of energy and the best use of the deposit.

### **Operational data**

Generally, fuel and energy are the most costly factors in the burning of lime, and energy efficiency improvements have been made to minimise production costs. In some cases in Germany, electricity consumption for lime grinding was minimised by replacing quicklime mills with mills operating like high pressure grinding (e.g. roller mill). The use of high pressure grinding mills was reported to generate electric energy savings of 2.5 kWh/t<sub>quicklime</sub>. Furthermore in one specific case, a reduction of electricity consumption was also achieved by replacing wet scrubbers with fabric filters. In this case, electrical energy savings of 2.9 kWh/t<sub>quicklime</sub> were reported [46, Germany, 2006].

### **Applicability**

Applicable, in principle, to all types of lime kilns.

Vertical kilns can usually only burn coarse limestone pebbles. However, rotary kilns with a higher energy consumption can also valorise small fractions and new vertical kilns tend to burn small granules from 10 mm. The bigger granules of kiln feed stone is used more in vertical kilns than in rotary kilns.

### **Economics**

No data available.

### **Driving force for implementation**

Legal requirements.

Natural resources.

Reduction of costs.

### **Example plants and reference literature**

Lime plants in the EU-27.

[46, Germany, 2006], [54, EuLA, 2006], [168, TWG CLM, 2007].

In this context, useful information can also be found in the Reference Document on Best Available Techniques for Energy Efficiency (ENE) [181, European Commission, 2008].

## **2.4.3 Process control optimisation**

### **Description**

Optimisation is applicable through process automation of most process steps in the whole lime manufacturing process. Maintaining kiln control parameters close to their optimum values has the effect of reducing all consumption and emissions parameters in the lime burning process. This is due to, among other things, reduced numbers of shutdowns and upset conditions. Management systems can be operated to ensure that good operating and maintenance practices are adopted and followed by all concerned, and that their observance is monitored.

### **Achieved environmental benefits**

Process control optimisation techniques have a positive effect on energy use and on emissions.

### **Cross-media effects**

None.

### **Operational data**

Depending on the optimisation task.



**Applicability**

Applicable to all lime plants to varying degrees.

Complete process automation is generally not achievable due to the uncontrollable variables, i.e. quality of the limestone.

**Economics**

Depending on the optimisation task.

**Driving force for implementation**

Legal requirements.

**Example plants and reference literature**

Lime plants in the EU-27.

[54, EuLA, 2006].

## 2.4.4 Choice of fuels (including waste fuels)

**Description**

The lime industry is an energy intensive industry (see Section 2.2.4). Depending on the chemical composition of the fuel and the type of kiln used, the choice of appropriate fuels or a fuel mix can lead to emissions reductions and improved firing efficiency, such as:

- low sulphur content fuels lead to a reduction in energy linked SO<sub>2</sub> emissions. However, as sulphur from the fuels is chemically absorbed by the lime, some fuels with a higher sulphur content can be used in lime production without increasing the SO<sub>2</sub> emissions
- biomass contributes to saving fossil fuels
- waste fuels reduce the amount of fossil fuels used and the related CO<sub>2</sub> emissions (see Section 2.2.5) while, however, solid fossil fuels contribute to higher CO<sub>2</sub> emissions.

Except for mixed feed shaft kilns, all types of kilns can operate with all types of fuels. Some kilns operate with only one type of fuel while the majority of kilns operate with a mixture of fuels. Depending on the kiln type, gaseous, solid and liquid fuels may be used. Solid fuels can be further divided into powder and lump fuels which also can be used in combination depending on kiln type.

Up until 2008, the most common fuels used in the EU are natural gas and solid fuels, such as lignite, coal, petcoke and coke. However, liquid fuels as well waste fuels and/or biomass with a high calorific value and a high reactivity are also used.

The selection of suitable waste fuels for the process and burner (e.g. waste oil, used solvents, animal fat, liquid waste) along with certain characteristics, criteria and constant qualities (e.g. high calorific value, high reactivity, low content of sulphur, chlorine, metals and ash as well as quantitative availability) reduces the amount of fossil fuels (see Section 2.2.5). To guarantee the characteristics of the waste fuel, a quality assurance system is required. In particular, this includes provisions for the sampling, the sample preparation, the analysis and the external monitoring. More useful information can be found in the technical specifications of the European Committee for Standardisation, such as CEN/TC 343 'Solid Recovered Fuels'.

**Achieved environmental benefits**

The choice of appropriate fuels or fuel mix can lead to emissions reduction and improved firing efficiency.

### **Cross-media effects**

Higher emissions may occur depending on the chemical composition of the fuel and the type of kiln.

It has to be noted that by using wastes it may be possible that different types of additional emissions occur.

Furthermore, a variation in the fuel mix often induces a variation in the specific energy consumption per tonne of lime. Depending on the types of waste fuels used and their calorific value, the annual average specific thermal energy demand can increase, as observed in the cement industry (see Section 1.3.3 regarding the cement industry). This observation from the cement industry is comparable with the use of waste in the lime industry.

### **Operational data**

When changing the fuel mix used, the specific energy consumption per tonne of lime can vary due to various reasons, depending on the type of fuel and the calorific value of the fuels used. Literature shows that fossil fuels have calorific values (average, net) of, e.g. 26 – 30 MJ/kg for typical coal and 40 – 42 MJ/kg for typical fuel oil, while solid waste like plastic material has a high calorific value of between 17 and 40 MJ/kg. It has to be noted that, of these wastes the calorific values vary very widely, from 3 to 40 MJ/kg. However, fuels with a calorific value of less than 18 MJ/kg are not suitable for the lime industry because of the ash and the moisture content (see also examples shown in Table 6.41). Calorific values of animal meal (carcase meal) used in lime kilns is in a range of between 14 and 21.5 MJ/kg as reported.

### **Applicability**

Each type of kiln is, in principle, capable of firing different types of fuels, but needs the technical equipment to actually do so. This may also include receiving and storing the fuels. The kilns should also be equipped with the fuel-specific burning technique or lances. Most of the plants within the EU are more or less fuel flexible depending on their location and the economic factors mentioned above. However, a change of fuel type may require significant investments.

It has to be noted that by using liquid wastes, low viscosity of these waste fuels is needed and often fuel preheating is necessary (60 to 70 °C). Furthermore, by using animal fat this waste material solidifies at temperatures of 40 °C due to its viscosity and may plug pipes and fittings. Handling of animal fat above temperatures of above 40 °C is necessary by, e.g. using additional heating.

Solid fluffy waste fuels can only be used in rotary kilns. Furthermore, pulverised waste fuels can be used in rotary kilns, in parallel flow regenerative kilns and in special types of shaft kilns. However, pulverised waste fuels are not available in 2008 for the use in the lime industry because of high costs for pulverising fluffy wastes by crushing.

The selection of the appropriate fuels depends on the type of kilns used, the desired product qualities, availability of the fuels and on the technical possibilities of injecting them into the selected kiln. Their use is mainly limited by:

- physico-chemical properties that do not always meet the relevant physical, chemical or process-specific requirements
- availability on the market and guaranteed supply of overtime
- economic considerations
- level of emissions.

Information concerning the use of waste fuels can be found in Section 2.2.5.

### Economics

The most important economic parameters are:

- cost of the fuel itself, i.e. the cost of fuel per tonne of lime can represent 30 to 60 % of the production cost
- spread between natural gas and solid fuels prices which varies over time
- impact of CO<sub>2</sub> allowance costs
- investment costs for the equipment required for the use of a particular fuel, e.g. storage, handling, drying, milling, injection, and safety.

### Driving force for implementation

Legal requirements.

Economic requirements.

Local conditions.

### Example plants and reference literature

Lime plants in the EU-27.

[54, EuLA, 2006], [143, Williams, 2005], [155, Germany, 2007], [168, TWG CLM, 2007], [182, TWG CLM, 2008].

## 2.4.5 Emissions of dust (particulate matter)

In this section, techniques to prevent channelled (see Section 2.3.3.1.1) and diffuse (see Section 2.3.3.1.2) dust emissions are described.

In this context, useful information can also be found in the Reference Document on Best Available Techniques on Emissions from Storage of bulk or dangerous materials and in the Reference Document on Best Available Techniques on Common Waste Water and Waste Gas Treatment/Management Systems in the Chemical Sector [58, European Commission, 2003], [96, European Commission, 2006].

### 2.4.5.1 Techniques for dusty operations

#### Description

Several different techniques are presented here, which can be applied individually or in combination (see Section 2.3.3.1.2):

- enclosure/encapsulation of dusty operations, such as grinding, screening and mixing
- covered conveyors and elevators, which are constructed as closed systems, if dust emissions are likely to be released from dusty material
- storage silos with adequate capacity, level indicators with cut out switches and with filters to deal with dust-bearing air displaced during filling operations
- a circulation process is favoured for pneumatic conveying systems
- material handling in closed systems maintained under negative pressure and dedusting of the suction air by a fabric filter before being emitted into the air
- reduction of air leakage and spillage points, completion of installation
- proper and complete maintenance of the installation
- use of automatic devices and control systems
- use of continuous trouble free operations
- use of flexible filling pipes equipped with a dust extraction system for loading burned lime which are positioned to the loading floor of the lorry.

### **Achieved environmental benefits**

Reduction of primarily diffuse dust emissions.  
Noise reduction is also possible by enclosing machinery.

### **Cross-media effects**

Increase in energy consumption from the use of vacuum systems.  
When maintenance is carried out, additional waste may occur.

### **Operational data**

Depending on the particular individual case related measure/technique.

### **Applicability**

These techniques can, in principle, be carried out in the lime industry.  
In raw material preparation operations, like crushing and sieving, dust separation is not normally applied, because of the moisture content of the raw material. To reduce emissions of dust, raw materials can be humidified by additionally spraying of water during processing.

### **Economics**

Depending on the particular individual case related measure/ technique.

### **Driving force for implementation**

Legal requirements.  
Health and safety requirements for the workplace.

### **Example plants and reference literature**

Lime plants in the EU-27.  
[46, Germany, 2006], [54, EuLA, 2006].

## **2.4.5.2 Techniques for bulk storage areas and stockpiles**

### **Description and achieved environmental benefits**

In order to primarily reduce diffuse dust emissions from bulk storage, from stockpiles from the locations of dusty raw materials or from fuels into the open air, storage locations can be enclosed with screening, walling or with vertical greenery (artificial or natural wind barriers for open pile wind protection).

Product silos and closed fully automated raw material storages are considered to be the most efficient solution for the problem of diffuse dust generated by high volume stocks. These types of storage are equipped with one or more fabric filters to prevent diffuse dust formation in loading and unloading operations (such as closed storage with an automatic handling system). Diffuse dust emissions at stockpiles can be reduced by using sufficient humidification of stockpile charging and discharging points and the use of conveyor belts with adjustable height. If diffuse dust emissions at charging or discharging points of storage sites cannot be avoided, they can be reduced by matching the discharge height to the varying height of the heap, if possible automatically, or by reduction of the unloading velocity.

Additionally, the locations can be kept wet by using spraying devices, especially in dry areas (if the point source of dust is locally limited, a water spray injection system can be installed), and can be cleaned by cleaning lorries. Furthermore, when using humidification or spraying techniques, the ground can be sealed and the surplus water can be gathered, and if necessary this can be treated and used in closed cycles.

To prevent the formation of diffuse dust emissions during removal operations, vacuum systems can be used. New buildings can easily be equipped with stationary vacuum cleaning systems, while existing buildings are normally better fitted with mobile systems and flexible connections.

To reduce diffuse dust emissions arising in areas used by lorries, these areas can be paved when possible and the surface should be kept as clean as possible. Wetting the roads can reduce diffuse dust emissions, especially during dry weather. Good housekeeping practices can be used in order to keep diffuse dust emissions to a minimum.

**Cross-media effects**

Water consumption increases when keeping locations wet.  
Energy consumption increases from the use of vacuum systems.  
When maintenance is carried out, additional waste may occur.

**Operational data**

Depending on the particular individual case related measure/technique.

**Applicability**

The techniques can, in principle, be carried out in the lime industry.

**Economics**

Depending on the particular individual case related measure/technique.

**Driving force for implementation**

Legal requirements.  
Health and safety requirements for the workplace.

**Example plants and reference literature**

Lime plants in the EU-27.  
[46, Germany, 2006], [54, EuLA, 2006], [168, TWG CLM, 2007].

**2.4.5.3 Reduction of channelled dust emissions**

This section describes techniques which are aimed exclusively at dust removal (see Section 2.3.3.1.1). There are different main sources of dust emissions from lime plants, such as from raw material preparation, calcining of limestone, lime hydrating, lime grinding and from connected and subsidiary processes. Depending on the kiln type used for lime manufacturing, different dedusting techniques are used. The dedusting techniques are based on filtering, on electrostatic separation and on wet scrubbing (flue-gas cleaning with a filter). These techniques are linked to the following characteristics of the flue-gas:

- temperature
- flowrate
- humidity
- dust concentration at the filter inlet.

Table 2.35 presents a summary of the operational data which are available within the text of this section. This table gives an overview and should be read in conjunction with the corresponding sections and paragraphs below.

Measure/ technique	Applicability	Emissions data <sup>(4)</sup>		Costs <sup>(3)</sup>	
		mg/Nm <sup>3</sup> <sup>(1)</sup>	kg/tonne <sup>(2)</sup>	Investment million EUR	Operating EUR/t lime
ESP	All kiln systems, milling plants, subsidiary processes	<10 – <20	0.015 – 0.1	0.6 – 3.9	>1.5
Fabric filter	All kiln systems	<10 – <20	0.015 – 0.15	0.25 – 1.7	>1.5
	Milling plants, subsidiary processes	<10 – <20	0.015 – 0.05		
Wet dust separator	All kiln systems, hydrating plants	10 – 30	0.06 – 0.25		
Centrifugal separator	Only suitable as pre- separators: all kiln systems, mills, subsidiary processes	-	-		
Diffuse dust abatement	All plants	-	-		

(<sup>1</sup>) For kiln systems normally referring to daily averages, dry gas, 273 K, 101.3 kPa and 11 % O<sub>2</sub>  
(<sup>2</sup>) kg/tonne lime based on:  
• 3000 Nm<sup>3</sup>/t lime for ASK and PFRK  
• 3700 Nm<sup>3</sup>/t lime for PRK  
• 5000 Nm<sup>3</sup>/t lime for LRK  
(<sup>3</sup>) Referring to different kiln capacities, see Figure 2.46 and Table 2.36  
(<sup>4</sup>) Emissions data can be found in the corresponding paragraph of this section

**Table 2.35: Overview of techniques for controlling dust in the lime production process**

ESPs and fabric filters both have a very high dedusting efficiency during normal operation of more than 99 % particulate retention, although both depend on particle size. Depending upon the exhaust gas temperature, different types of filter media have to be used. Both types of filter systems have to be properly (periodically) maintained to ensure the adequate efficiency which is higher than in the case of wet dust separators. Wet dust separators consume additional energy as well as water and produce waste water which then has to be treated. The efficiency of ESPs may be affected by CO trips; however, CO trips can be minimised as per Section 6.2.6. Centrifugal separators are also used but are only suitable as pre-separators; however, they can perform more efficiently with higher pollutant loadings. For diffuse dust abatement, see Sections 2.4.5.1 and 2.4.5.2.

#### 2.4.5.3.1 Electrostatic precipitators (ESPs)

##### Description and achieved environmental benefits

In an electrostatic precipitator, the flue-gases are passed through a chamber with two electrodes. A high voltage (up to 100 kV) is applied to the first electrode, which ionises the flue-gases. The ions generated adhere to the dust particles in the flue-gases, and as a result these particles become electrically charged. Electrostatic forces repel the charged dust particles from the first electrode and attract them to the second, on which they are deposited. So the dust particles are removed from the flue-gas stream.

Electrostatic precipitators generate an electric field across the path of particulate matter in the air stream. The particles become negatively charged and migrate towards positively charged collection plates. The collection plates are rapped or vibrated periodically, dislodging the material and allowing it to fall into collection hoppers below. ESPs are characterised by their ability to operate under conditions of high temperature (up to approximately 400 °C) and high humidity. Factors affecting efficiency are flue-gas flowrate, strength of the electric field, conductivity of the dust, SO<sub>2</sub> concentration, moisture content, and shape and area of the electrodes. In particular, the electric field can be unfavourably reduced by a build-up of material that forms an insulating layer on the collection plates as shown in Figure 2.43.

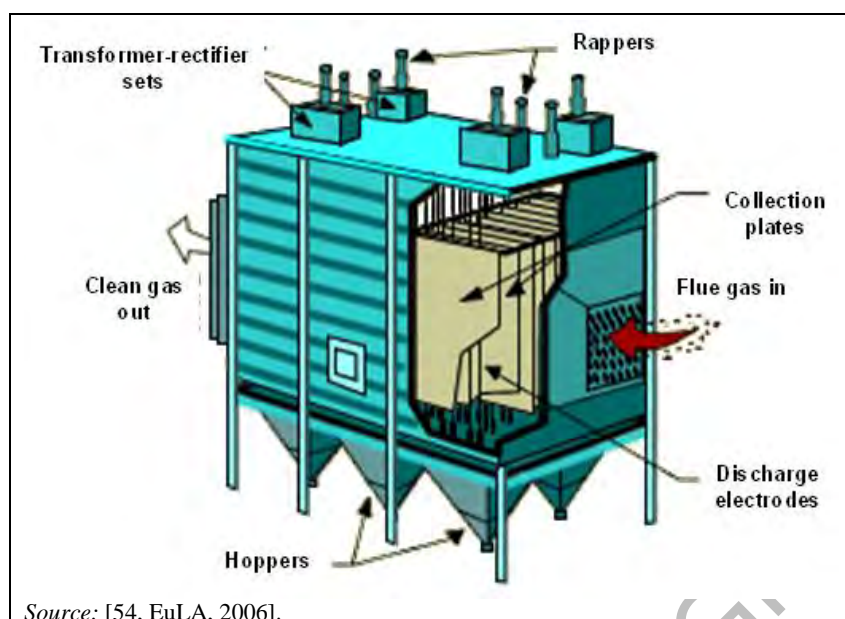


Figure 2.43: Schematic view of a conventional electrostatic precipitator (ESP)

Because of explosion risks, the CO safety concentration at the inlet of the ESP is usually limited to 1 to 2 % which is well below the explosion limit of 10 %. Therefore, CO trips must be avoided, thus requiring the CO levels to be monitored continuously before the filter. The number of CO trips can be reduced by using modern control systems with fast measuring and control equipment which allows a higher switch-off criterion. In this context, a guideline regarding the control of CO trips can be found in Section 6.2.6.

When justified, quenching towers before the ESP can be installed to improve cleaning of emissions like PCDD.

#### Cross-media effects

Explosion risks arise at high CO concentrations.

The energy consumption increases due to the operation of the ESP (but a lower pressure drop compared to other filter systems leads to lower electrical energy consumption of flue-gas fans). Additional waste occurs.

#### Operational data

During stable operating conditions, electrostatic precipitators can reliably achieve dust emissions of between 5 and 20 mg/Nm<sup>3</sup> (see Section 2.3.3.1.1). In 2005, examples from Finnish lime plants showed that dust emissions of less than 5 mg/Nm<sup>3</sup> were achievable on spot measurements by using coke and coal as fuels in rotary kilns.

The efficiency of an existing ESP can be improved by the addition of chambers (electrical fields) in line. However, this improvement is only realistic if the actual dust emission level is high and providing that there is sufficient space.

#### Applicability

Electrostatic precipitators are suitable for use at temperatures above the dew point and up to 400 °C (with mild steel construction). Furthermore, it is also possible to use ESPs close to, or below, the dew point.

Because of high volume flows and relatively high dust loads, mainly rotary kilns without preheaters but also rotary kilns with preheaters are equipped with ESPs. In some cases, this is because of the high exhaust gas temperature, in others it is because the kilns have large production capacities and consequently produce large volumes of gases. In the case of combination with a quenching tower, excellent performance can be achieved.

### **Economics**

The investment costs of ESPs relative to fabric filters increase with the kiln size and the daily production capacity as shown in Figure 2.46.

### **Driving force for implementation**

Legal requirements.  
Flue-gas temperature and flowrate.  
Investments (local circumstances).  
Running operational cost.  
Energy consumption.  
Proven technique.

### **Example plants and reference literature**

Lappeenranta, Nordkalk Oy (Finland), Rheinkalk GmbH Flandersbach (Germany), Hönnetal (Germany), lime plants in the EU-27.  
[54, EuLA, 2006], [63, Finland, 2006], [168, TWG CLM, 2007].

#### **2.4.5.3.2 Fabric filters**

##### **Description and achieved environmental benefits**

In a fabric filter, the basic principle of filtration is to use a fabric membrane which is permeable to gas but will retain the dust particles. Initially, dust is deposited both on the surface and within of the depth of the fabric. As the surface layer builds up, the dust particles themselves become the dominating filter medium. As the dust layer thickens, the resistance to gas flow (pressure drop) increases.

Periodic cleaning of the medium is therefore necessary to control the gas pressure drop across the filter. Common cleaning methods include reverse airflow, mechanical shaking, vibration and compressed air pulsing (jet cleaning).

The cleaning system, the airflow and the aerial load of the medium are key elements for an efficient filtration. The filter should have multiple compartments (which have an impact on investment costs and on the size of the filter – surface and volume) which can be isolated in cases of bag failure and there should be sufficient of these to allow adequate performance to be maintained if a compartment is taken off line, e.g. for maintenance. Furthermore, there should be ‘burst bag detectors’ on each compartment to indicate the need for maintenance when this happens.

The dust will be stored in a bunker, a so-called ‘dust hopper’ (part of the compartment), and extracted by screw conveyors, flaps and or rotating valves as shown in Figure 2.44.

Fabric filters can be operated overpressure as well as under suction conditions.



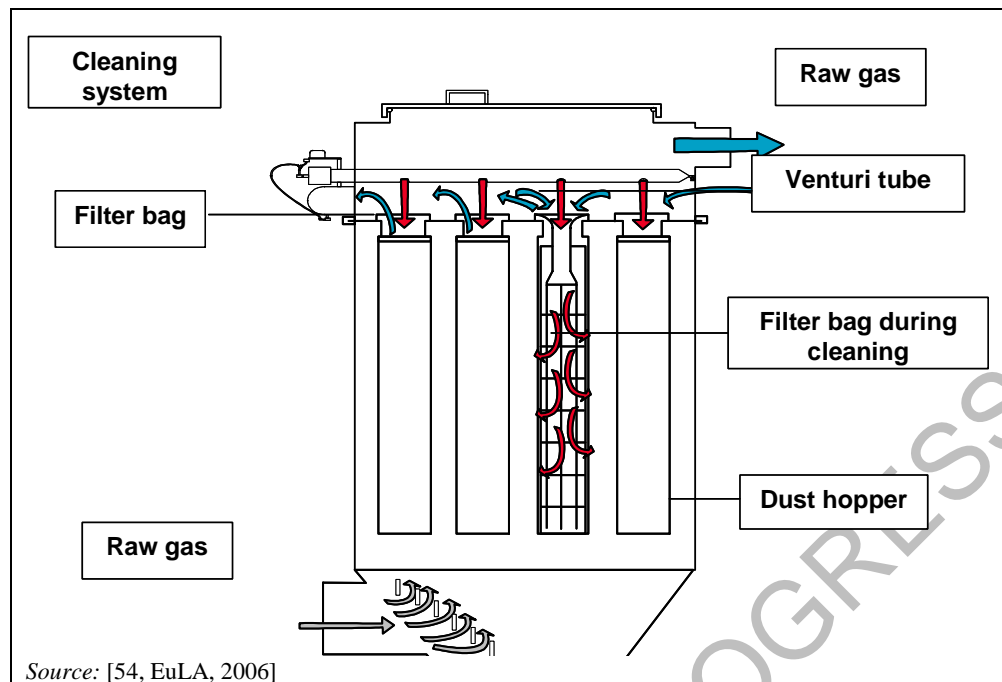


Figure 2.44: Schematic of a fabric filter with pulse jet cleaning

Depending on the exhaust gas temperature, different types of filter medium can be used. The cause for short lifetimes of the bags can be:

- Start-up temperature conditions
- shutdown temperature conditions
- temperature excursions
- flue-gas composition
- lime dust behaviour (clogging).

In one case, the cause of the short lifetimes of the bags was considered to be the insufficient size of the filter. The problem was solved by enlarging the filter and it was then achieving less than 5 mg/Nm<sup>3</sup> with a 2 year lifetime guarantee on the bags. Bags of special materials and qualities have also been used, and they have also had problems with short lifetimes in some cases. At one plant, the periodically excessive operating temperature was deemed to cause the problems [24, Junker, 2001].

#### Cross-media effects

Increasing the specific energy consumption due to the high pressure drop (fabric filter medium and dust layer on the surface).

Increasing the energy consumption and CO<sub>2</sub> emissions due to additional heating of flue-gases with a high moisture content and low temperature (<120 °C) in order to prevent the corrosion of the filter and the clogging of the bags.

Operation of fabric filters, especially with pressure pulse regeneration, may cause noise emissions.

In some cases, small defaults in the weldings and starting of corrosion (which are difficult to detect) can create a bypass and lead to increased dust emissions above the level which is observed during routine operations.

Insufficient filter area will cause too high a filtration speed when cooling air is bleeding into the filter.

Additional waste occurs.

### Operational data

Fabric filters are generally operated at temperatures above the dew point – up to 180 – 200 °C for special cloth, and up to 250 °C for filter media such as fibreglass and ‘Teflon’. However, they can be used at the dew point for treating emissions from hydrating plants.

For well designed, operated and maintained fabric filters (continuous dedusting of the filter bags), dust emissions of less than 10 mg/Nm<sup>3</sup> (60 % from the EU-27) are achieved and dust emissions of below 20 mg/Nm<sup>3</sup> are recorded. In one Finnish lime plant, dust emissions, measured once a year, ranged from 0.7 – 1.1 mg/Nm<sup>3</sup> (4.3 % O<sub>2</sub>) in 2004 and from 1.7 – 2.2 mg/Nm<sup>3</sup> (4.3 % O<sub>2</sub>) in 2005. These emissions were achieved in an annular shaft kiln using fabric filters and heavy and light fuel for combustion. Furthermore in Finland in 2004, one PFRK achieved dust emissions of 6 mg/Nm<sup>3</sup> (short term, 9.6 % O<sub>2</sub>) by using fabric filters and coke gas as fuel (see also Table 6.37). In 2005, dust emissions ranges of between 1.7 and 2.2 mg/Nm<sup>3</sup> were achieved in an annular shaft kiln by using a fabric filter (single measurements).

The efficiency and the bag loading of the fabric filters are generally monitored by measuring the pressure drop between the raw and clean gas. Fabric filter plants achieve high particulate retention, typically over 98 and up to 99.9 % depending on the particle size and they can be used in all types of kilns (see Section 6.3.2.3).

### Applicability

Fabric filters for dust removal from off-gases can, in principle, be applied in the lime industry to all types of lime kilns and are widely used for dedusting. They are well suited for kilns, milling and grinding plants for quicklime as well as for limestone; hydration plants; material transport; and storage and loading facilities. Often a combination with cyclone prefilters is useful.

The operation of fabric filters is limited by the flue-gas conditions such as temperature, moisture, dust load and chemical composition. There are various fabric materials available to resist mechanical, thermal and chemical wear to meet those conditions.

The operation temperatures can be as high as 250 °C for kiln flue-gases using thermo-resistant media. Temperatures above this require cooling of the gas by quenching with water or fresh air.

Flue-gases with a high moisture content and low temperature (<120 °C) need to be heated in order to prevent the corrosion of the filter and the clogging of the bags. This fact requires an additional heating system to be installed before the filter. The filter casing is often insulated and critical parts are heated and/or made of stainless steel.

The high velocity of the flue-gases will reduce the effectiveness of the bag cleaning. Consequently, the pressure of the cleaning air has to be increased to get the bags cleaned and this will shorten the life duration of the bags. A filtration speed of 0.9 – 1.2 m/min has been recommended.

It is necessary to have complete control of the laminar flow into the filter to avoid damage to the filter bag and to the steel construction. This is not simulated by models but has to be found out by operating experience, e.g. how to position the muffles. This is a question of which type of filter materials used as well as of the gas flow distribution within the filter. It is also important to operate above the dew point as otherwise the steel construction will corrode. In some cases when (large) problems with corrosion occur, some parts of the filter have to be built in stainless steel.

**Economics**

The investment costs for fabric filters increase with the kiln size and the daily capacity as shown in Figure 2.46 (see Section 2.4.5.3.5). The maintenance and energy costs are shown in Figure 2.47 and Figure 2.48 (see Section 2.4.5.3.5).

In Austrian lime plants, investment costs for installing a fabric filter were between EUR 350000 and 500000, without the filter itself and without peripheries. Operating costs are about EUR 0.5 – 1.0 per tonne [66, Austria, 2006].

**Driving force for implementation**

Legal requirements.

Flue-gas temperature and flowrate.

Investment costs (local circumstances).

Running operational costs.

Energy consumption.

Proven technique.

**Example plants and reference literature**

Lime plants in the EU-27, Tytyri plant in Finland.

[24, Junker, 2001] [45, Schorcht, 2006], [54, EuLA, 2006], [63, Finland, 2006], [66, Austria, 2006], [168, TWG CLM, 2007], [182, TWG CLM, 2008].

**2.4.5.3.3 Wet dust separators****Description and achieved environmental benefits**

With wet dust separators, dust is eliminated from off-gas streams by bringing the gas flow into close contact with a scrubbing liquid (usually water), so that the dust particles are retained in the liquid and can be rinsed away. Wet dust separators can be divided into various types according to their design and working principles (for instance, venturi type), but the most common types used for lime kilns are multi-cascade/multistage scrubbers, as shown in Figure 2.45.

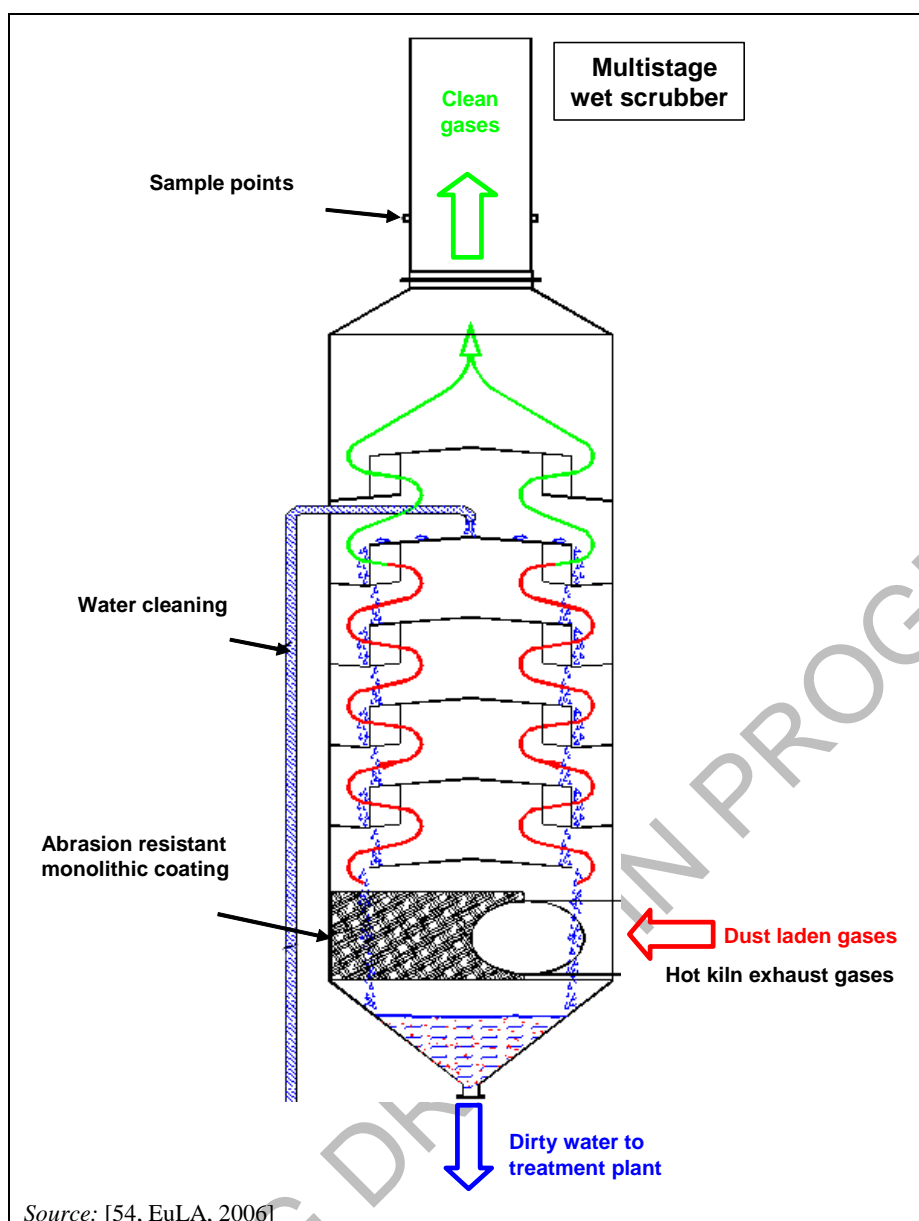


Figure 2.45: Schematic view of an exhaust gas multistage wet scrubber example

The raw gases from the kiln pass through the multi-cascade/multistage scrubber before being discharged to the air. Water is pumped to the unit and then cascades down through the several sections where the dust is entrained and finally drains away to the water treatment plant. The sludge produced from a kiln wet scrubber can be sold as a neutralising product or is disposed of after dewatering. The water is generally recycled.

There are a number of different types of wet scrubbers available for dust removal. The main types that have been used in lime kilns are multi-cascade/multistage wet scrubbers, dynamic wet scrubbers and venturi wet scrubbers. The majority of wet scrubbers used on lime kilns are multi-cascade/multistage wet scrubbers as shown in Figure 2.45. In order to achieve the lower clean gas loadings, the units may need to be oversized for the duty, have additional cascade sections or have a low inlet dust burden due to washed stone.

By using the venturi scrubber, the gas is forced to pass through a pipeline, in which velocities reach 60 to 120 m/s. Water added upstream of the pipeline is shattered into fine drops by pneumatic forces, and is thus intimately mixed with the gas. Dust particles, trapped by the droplets, become heavier and are easily removed in an entrainment separator (usually cyclonic) attached to the venturi scrubber.

The collected material is in the form of sludge so there are no diffuse dust emissions when handling this material. Given a constant water feed, the performance of the wet scrubber will remain constant and does not require consumable parts to be replaced.

### **Cross-media effects**

Water consumption will be increased.

Clean gases content of higher moisture.

At the kiln chimney, a plume may be visible as a result of its high moisture content depending on atmospheric conditions and relative humidity.

Additional waste water may occur.

Scrubbing liquid and process waste water cleaning, sludge handling, utilisation and disposal have also to be taken into consideration.

Additional energy may be used for waste water treatment.

Noise may occur.

In order to achieve lower clean gas loadings, the units may need to be oversized, have additional cascade sections or have a low inlet dust burden due to washed stone.

Additional investment and maintenance costs may occur.

### **Operational data**

By using new generations of wet scrubbers, emission levels after abatement range from 10 to 30 mg/Nm<sup>3</sup>, corresponding to approximately 0.008 to 0.024 kg/tonne hydrated lime. In the UK in 2007, the most modern wet scrubbers showed results of 11 mg/Nm<sup>3</sup>, 17 mg/Nm<sup>3</sup> and 18 mg/Nm<sup>3</sup>. However, dust emissions of up to 60 mg/Nm<sup>3</sup> were also reported (expressed in wet conditions) [168, TWG CLM, 2007], [177, EULA, 2008].

When operated efficiently, multi-cascade/multistage wet scrubbers can achieve clean gas concentrations of less than 30 mg/Nm<sup>3</sup>; however, in most cases the dust emissions are higher than 30 mg/Nm<sup>3</sup>. Figure 2.35 (see Section 2.3.3.1.1) shows that only approximately 30 % of the wet scrubbers achieved emission levels of below 30 mg/Nm<sup>3</sup>, approximately 12 % below 20 mg/Nm<sup>3</sup> and none below 10 mg/Nm<sup>3</sup>. However, the lower range is achieved by efficient operation of multi-cascade/multistage wet scrubbers and/or by using new generations of wet scrubbers.

In comparison with ESPs and fabric filters, the achievable emission level of wet scrubbers may be significantly higher.

The typical water consumption of a multi-cascade/multistage wet scrubber is around 100 l/t lime.

### **Applicability**

Wet scrubbers are chosen when the exhaust gas temperatures are close to, or below the dew point. They may also be chosen when space is limited.

Wet scrubbers are sometimes used with higher temperature gases, in which case, the water cools the gases and reduces their volume.

### **Economics**

Regarding operating costs, scrubbing liquid and process waste water cleaning both have to be taken into consideration.

### **Driving force for implementation**

Legal requirements.

### **Example plants and reference literature**

Shapfell Limeworks, UK.

[54, EuLA, 2006], [168, TWG CLM, 2007], [177, EULA, 2008], [182, TWG CLM, 2008].

#### 2.4.5.3.4 Centrifugal separators/cyclones

##### **Description and achieved environmental benefits**

In a centrifugal separator/cyclone, the dust particles to be eliminated from an off-gas stream are forced out against the outer wall of the unit by centrifugal action and then eliminated through an aperture at the bottom of the unit. Centrifugal forces can be developed by directing the gas flow in a downward spiral motion through a cylindrical vessel (cyclonic separators) or by a rotating impeller fitted in the unit (mechanical centrifugal separators). However, they are only suitable as pre-separators because of their limited particle removal efficiency and they relieve ESPs and fabric filters from high dust loading, and reduce abrasion problems.

##### **Cross-media effects**

The operation of centrifugal separators is a significant source of noise.

##### **Operational data**

Typically cyclones remove about 90 % of the dust from lime kilns. As pre-separators/product separators they can typically only achieve dust emission values of less than 150 mg/Nm<sup>3</sup>.

Centrifugal separators perform more efficiently with higher pollutant loadings, provided that the device does not become blocked.

##### **Applicability**

Cyclones are relatively inexpensive and easy to operate, but particles with small diameters are not captured effectively. The application of centrifugal separators/cyclones may be limited when the particle size is too small. Because of their inherently limited particle removal efficiency, they are only suitable as pre-separators and are mainly used to pre-clean the exhaust gases from mills, kilns and other processes.

##### **Economics**

Cyclones are relatively inexpensive compared with ESPs and fabric filters. For fabric filters and ESPs, the investment costs (depending on kiln size and the daily capacity) are shown in Figure 2.46 and the maintenance and energy costs are shown in Figure 2.47 and Figure 2.48 (see Section 2.4.5.3.5).

##### **Driving force for implementation**

Legal requirements.  
Raw material savings.

##### **Example plants and reference literature**

Lime plants in the EU-27.  
[16, EuLA, 2001], [54, EuLA, 2006], [168, TWG CLM, 2007], [182, TWG CLM, 2008].

#### 2.4.5.3.5 Examples of cost data for different flue-gas cleaning techniques

Some examples of cost data regarding the abatement of dust emissions by using different abatement techniques are shown in Table 2.36.

There are three main dedusting techniques used for lime kilns:

- fabric filters
- electrostatic precipitators (ESPs)
- wet scrubbers.

Investments costs are affected by the size of the filter and the operating conditions. Temperatures and gas components can require several additional installations such as:

- insulation
- heating/cooling
- protection against corrosion and wear.

Therefore, a wide variation of investment costs exists. The main cost drivers are investments, maintenance and energy.

The investment costs of ESPs relative to fabric filters increase with the kiln size and the daily production capacity as shown in Figure 2.46.

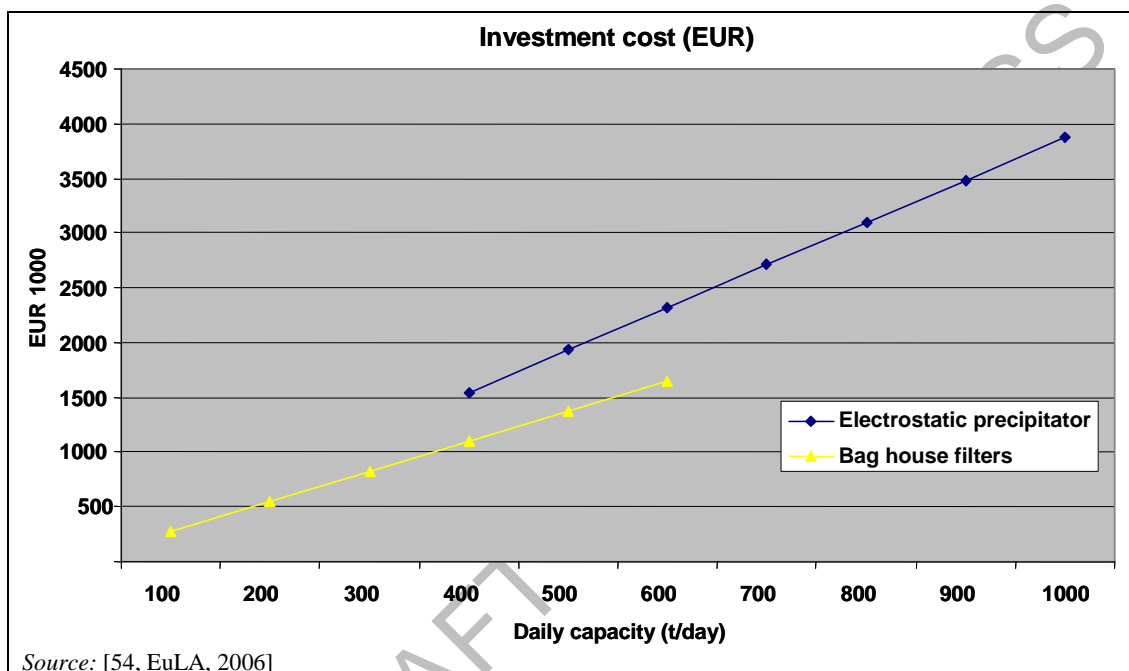


Figure 2.46: Investment costs as a function of kiln capacity for ESPs and fabric filters – EU-27

The investment costs for the equipment range from EUR 300000 to 4000000 depending on kiln capacity and the site-specific influences. The maintenance and energy costs are found to increase as the emission level lowers as shown in Figure 2.47 and Figure 2.48.

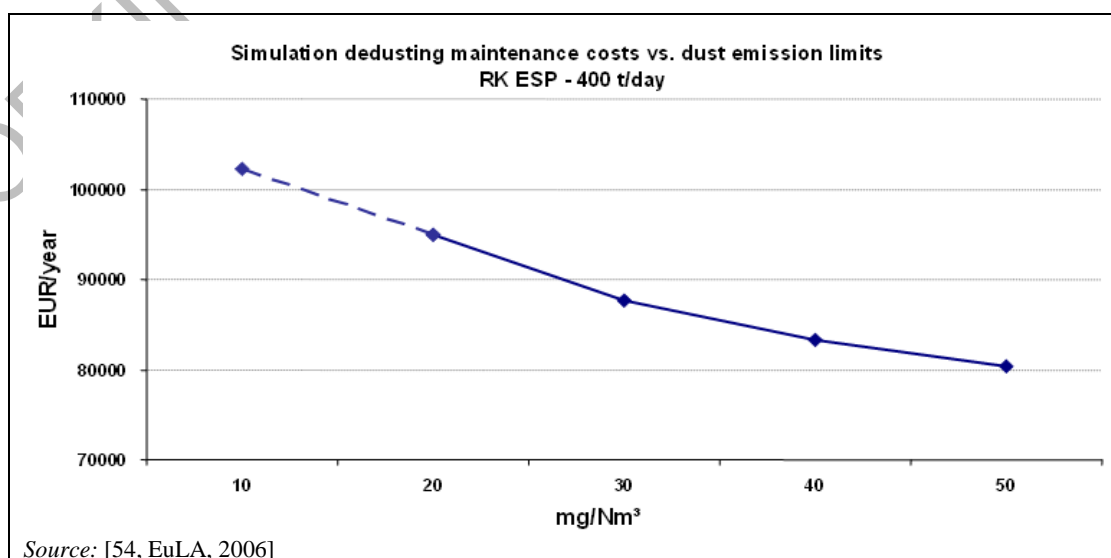
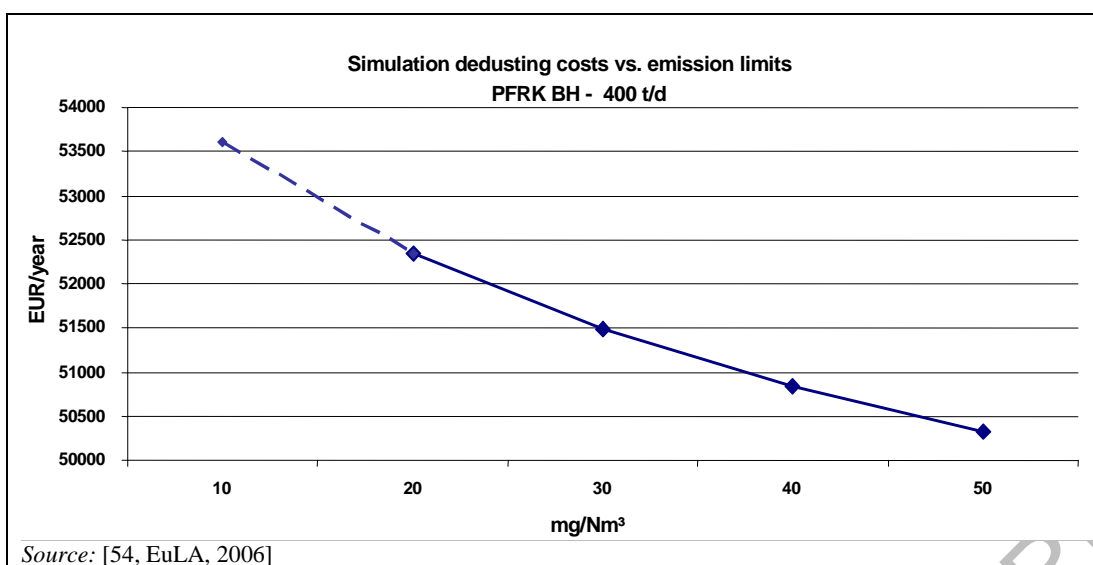
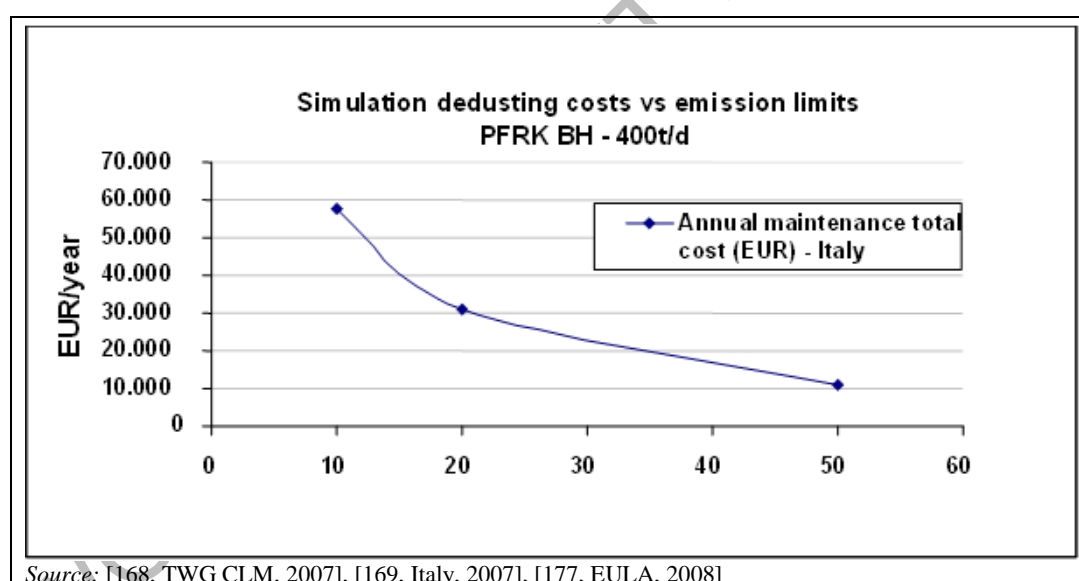


Figure 2.47: Simulation dedusting cost as a function of dust emission limits for a rotary kiln (RK) with an ESP – EU-27



**Figure 2.48:** Simulation of maintenance costs for dedusting as a function of dust emission limits for a PFRK and fabric filters – EU-27

In 2007 in Italy, a survey was carried out at 33 Italian PFRKs and the dedusting costs which depend on dust emissions ranges of PFRKs were investigated. This investigation showed a parabolic correlation between the costs for dedusting and the dust emissions concentration. The ratio of costs is around 2 for dust emissions ranges of between 20 and 50 mg/Nm<sup>3</sup> as well as for dust emissions ranges of between 10 and 20 mg/Nm<sup>3</sup>, as shown in Figure 2.49.



**Figure 2.49:** Simulation of maintenance costs for dedusting as a function of dust emissions ranges for PFRK and fabric filters in Italy in 2007

Table 2.36 below shows examples of cost calculations for dust abatement techniques from a French reference lime plant. The investigated dust abatement techniques of ESPs and fabric filters have been considered. Variable operating costs include electricity costs, labour costs and dust disposal costs and are mentioned at this table. Furthermore, data on wet scrubbers are included.



Investments and costs of dust abatement techniques				
Parameter	Unit	Abatement technique		
		ESP <sup>(0)</sup>	Fabric filter <sup>(0)</sup>	Wet scrubber
Description of reference installation				
Capacity	t of lime/d	140	140	
Capacity	t/yr			50 000
Plant factor	h/yr	7680	7680	
Exhaust gas flow	Nm <sup>3</sup> /h <sup>(1)</sup>	23 333	23 333	
Investment costs	k EUR	600	700	6 – 18
Annualised capital costs	k EUR			
Interest rate	%/100/yr	4	4	
Lifetime of the control equipment	yr	10	10	
Total	k EUR	73.97	86.30	
Total	k EUR/tonne lime	1.65E-03	1.93E-03	
Fixed operating costs	%/yr <sup>(2)</sup>	4	4	
Total	k EUR	24	28	
Total	k EUR/tonne lime	5.36E-04	6.25E-04	1.0 – 5.0E-04 (0.1 – 0.5 EUR/tonne lime)
Variable operating costs	k EUR/tonne lime	8.06E-04	9.03E-04	
Costs per tonne of lime	k EUR/tonne lime	2.99E-03	3.45E-03	
Costs per tonne of PM <sup>(3)</sup> abated	k EUR/t PM abated			
Unabated emissions factor	t PM/t lime	0.015	0.015	
Abated emissions factor	t PM/t lime	0.0002	0.0002	
Total	k EUR/t PM abated	0.202	0.233	
<b>Determination of the variable operating costs</b>				
Electricity costs <sup>(4)</sup>				
Additional electricity demand ( $\lambda^e$ ) <sup>(5)</sup>	kWh/t lime	6.86 40 kW	8.57 50 kW	
Electricity price ( $c^e$ )	EUR/kWh	0.0569	0.0569	
Total	k EUR/tonne lime	3.90E-04	4.88E-04	
Labour costs <sup>(6)</sup>				
Labour demand ( $\lambda^l$ )	man-year/t lime	1.12E-05	1.12E-05	
Wages ( $c^l$ )	k EUR/man-year	37.234	37.234	
Total	k EUR/tonne lime	4.16E-04	4.16E-04	
Dust disposal costs <sup>(7)</sup>				
Total	k EUR/tonne lime	0	0	
Total variable operating costs	k EUR/tonne lime	8.06E-04	9.03E-04	
K EUR = EUR thousand <sup>(0)</sup> 2000 data <sup>(1)</sup> 10 % O <sub>2</sub> and dry gas <sup>(2)</sup> Of investment <sup>(3)</sup> Repartition 50 % of ESP and 50 % of fabric filter; use of average between ESP and fabric filter <sup>(4)</sup> Electricity costs = $\lambda^e \cdot c^e / 10^3$ (k EUR/t) <sup>(5)</sup> Additional electricity demand = new total consumption - old total consumption <sup>(6)</sup> Labour costs = $\lambda^l \cdot c^l$ (k EUR/t) <sup>(7)</sup> Dust disposal costs = $\lambda^d \cdot c^d \cdot ef_{unabated} \cdot \eta / 10^3$ (k EUR/t) $ef_{unabated}$ : unabated emissions factor of pollutant (t pollutant/t) $\lambda^d$ : demand for dust disposal (t/t pollutant removed) $c^d$ : specific dust disposal cost (EUR/t) $\eta$ : removal efficiency (=1- $ef_{abated}/ef_{unabated}$ ) Source: [61, France, 2006, 62, France/DFIU/IFARE Karlsruhe, 2004]				

Table 2.36: Investments and costs of dust abatement techniques

Related to the cost calculation from Table 2.36 and especially regarding the different costs included in the operational costs, the proportions of them are shown in Table 2.37 below.

Proportional costs included in variable operating costs			
Type of costs	Unit	Abatement measure/technique	
		ESP	Fabric filter
Electricity costs	%	48.42	53.99
Labour costs	%	51.58	46.01
Dust disposal costs	%	0.00	0.00
Total variable operating costs	%	100.00	100.00
<i>Source: [61, France, 2006]</i>			

**Table 2.37: Proportions of different kinds of costs included in operating costs for abatement techniques**

In Austria, installation costs for a fabric filter were between EUR 350000 and 500000. The costs of the peripheries are not included within these installation costs [66, Austria, 2006].

## 2.4.6 Gaseous compounds

### 2.4.6.1 Reduction of NO<sub>x</sub> emissions

The highest NO<sub>x</sub> emissions are observed for rotary kilns. Therefore, the priority is given to control the NO<sub>x</sub> emissions of rotary kilns (see Section 2.3.3.2).

The possibilities to reduce NO<sub>x</sub> emissions can be divided into:

- primary techniques aiming to reduce the formation of NO<sub>x</sub> and
- secondary techniques aiming to destroy nitrogen oxides by reducing them to N<sub>2</sub>.

Primary techniques involve in particular:

- fuel selection (limitation of nitrogen content in the fuel)
- process optimisation (flame shaping and temperature profile)
- burner design (low NO<sub>x</sub> burner)
- air staging.

These techniques are the most cost effective, but their efficiency is limited especially by the design of the combustion chamber of the rotary kilns and by the temperature levels required to maintain the quality of lime.

Secondary techniques can be split into:

- selective non-catalytic reduction (SNCR) and
- selective catalytic reduction (SCR).

Both techniques use nitrogen compounds, which react with the nitrogen oxides, so as to reduce them and to form N<sub>2</sub>. Catalytic processes usually involve high investment costs.

Table 2.38 presents NO<sub>x</sub> reduction techniques which can be applicable to certain lime kilns.

Measure/technique	Applicability	Reduction efficiency %	Emissions data <sup>(4)</sup> <sup>(5)</sup>		Costs <sup>(3)</sup>	
			mg/Nm <sup>3</sup> <sup>(1)</sup>	kg/tonne <sup>(2)</sup>	Investment	Operating
					EUR million	EUR/t lime
Process optimisation	PFRK, ASK, MFSK, OSK		<100 – <350 <sup>(9,10)</sup>	0.3 – 1.05		
	LRK, PRK		<200 – <500 <sup>(9,10)</sup>	0.74 – 2.5		
Air staging (in 2007, not applied in the lime industry in the EU-27)	LRK, PRK	-				
Low NO <sub>x</sub> burners	LRK, PRK	0 – 20			In the range of conventional burner techniques	In the range of conventional burner techniques
SNCR <sup>(11)</sup>	PRK (Lepol grate)	30 – 80	<500 <sup>(10)</sup>	<2.5	0.5 – 1.2	0.1 – 1.7 <sup>(7)</sup>
SCR (in 2007, not applied in the lime industry in the EU-27)	LRK, PRK	<sup>(6)</sup>	-	-	<sup>(8)</sup>	<sup>(8)</sup>

<sup>(1)</sup> For kiln systems normally referring to daily averages, dry gas, 273 K, 101.3 kPa and 11 % O<sub>2</sub>  
<sup>(2)</sup> kg/tonne lime based on:  
• 3000 Nm<sup>3</sup>/t lime for ASK and PFRK  
• 3700 Nm<sup>3</sup>/t lime for PRK  
• 5000 Nm<sup>3</sup>/t lime for LRK  
<sup>(3)</sup> Referring to different kiln capacities, see Figure 2.46 and Table 2.36  
<sup>(4)</sup> Standard state, 11 % oxygen  
<sup>(5)</sup> Emissions data can be found in the corresponding paragraph of this section  
<sup>(6)</sup> Depending on the catalyser used, see Section 2.4.6.1.5  
<sup>(7)</sup> Financial estimations based on the preliminary tests referring to a kiln capacity of 1000 t/day and initial emissions of up to 1500 mg NO<sub>x</sub>/Nm<sup>3</sup>  
<sup>(8)</sup> Similar to the cement industry (see Table 1.34 in Section 1.4.5.1, Section 1.4.8.2 and Section 2.4.6.1.5), however, related to higher specific volume in lime kilns, investment costs are expected to be higher in the lime industry compared to the cement industry  
<sup>(9)</sup> Level can be higher depending on product specifications, see Section 2.3.3.2 and Figure 2.36  
<sup>(10)</sup> Depends on the initial NO<sub>x</sub> level  
<sup>(11)</sup> In 2007, SNCR was only applicable to Lepol grate kilns; one lime kiln (Lepol grate) was equipped with SNCR

**Table 2.38: Overview of NO<sub>x</sub> reduction techniques in the lime industry**

Furthermore, Figure 2.36 (Section 2.3.3.2) shows that NO<sub>x</sub> emissions in vertical shaft kilns are generally lower than in rotary kilns because of the temperature dependence which results from the production of different types of lime by using different types of lime kilns. As also shown in Figure 2.36, around 68 % of the NO<sub>x</sub> emissions from rotary kilns are below 500 mg/Nm<sup>3</sup> (spot measurements as half hourly average values) and around 60 % of the NO<sub>x</sub> emissions from shaft kilns are below 100 mg/Nm<sup>3</sup>. Also, around 80 % of PFRKs, MFSKs and OSKs and approx. 50 % of ASKs achieve NO<sub>x</sub> emission values of <100 mg/Nm<sup>3</sup> measured as half hourly values (see Section 2.3.3.2).

#### 2.4.6.1.1 Process optimisation

##### Description

Optimisation of the process, such as smoothing and optimising the plant operation and/or homogenisation of the fuel and raw material feedings, can be applied for reducing NO<sub>x</sub> emissions. Significant parameters for process control optimisation in a lime kiln which can have a positive effect on NO<sub>x</sub> emissions by being optimised are:

- heating rate
- level of firing temperature
- excess air

- secondary air temperature
- pressure of jet air
- fineness of pulverised coal
- volatile content in the fuel
- position, length and temperature of the flame.

### **Achieved environmental benefits**

Reduction of emissions and energy usage.

### **Cross-media effects**

No cross-media effects reported.

### **Operational data**

As shown in Figure 2.36, around 68 % of the NO<sub>x</sub> emissions from rotary kilns are below 500 mg/Nm<sup>3</sup> (spot measurements as half hourly values) and around 60 % of the NO<sub>x</sub> emissions from shaft kilns are below 100 mg/Nm<sup>3</sup>. Furthermore, around 80 % of PFRKs, MFSKs and OSKs and approx. 50 % of ASKs achieve NO<sub>x</sub> emission values of <100 mg/Nm<sup>3</sup> measured as half hourly values (see Section 2.3.3.2).

### **Applicability and economics**

Optimisation of process and process control can be applied in lime manufacturing, but it should be noted that in practice, heating curves of the firing process in the lime industry are optimised in line with product quality and energy consumption. Therefore, heating curves can only be changed if the technical properties of the final product allow this and additional costs should be taken into account when altering heating curves for emissions reasons.

### **Driving force for implementation**

Legal requirements.

### **Example plants and reference literature**

Lime plants in the EU-27.

[54, EuLA, 2006], [168, TWG CLM, 2007].

#### **2.4.6.1.2 Air staging**

##### **Description and achieved environmental benefits**

Air staging can, in principle, be applied to rotary lime kilns. A reducing zone is created by reducing the oxygen supply in the primary reaction zones. High temperatures in this zone are particularly favourable for the reaction which reconverts the NO<sub>x</sub> to elementary nitrogen. At later combustion zones, the air and oxygen supply is increased to oxidise the gases formed. Effective air/gas mixing in the firing zone is required to ensure CO and NO<sub>x</sub> are both maintained at low levels.

##### **Cross-media effects**

No further information is available.

##### **Operational data**

In 2007, air staging had not yet been tested in the EU lime industry.

##### **Applicability**

In 2007, air staging had never been applied in the lime sector in the EU-27; however, tests have shown that it is applicable, in principle, to rotary kilns, but not to rotary kilns where hard burned lime is produced. Air staging is not applicable to shaft kilns.

##### **Economics**

No data available.

**Driving force for implementation**

Legal requirements.

**Example plants and reference literature**

In 2008, there were no example lime plants in the EU-27.

[54, EuLA, 2006], [168, TWG CLM, 2007], [182, TWG CLM, 2008].

**2.4.6.1.3 Low NO<sub>x</sub> burners****Description and achieved environmental benefits**

Emissions of nitrogen oxides depend mainly on the quality of lime produced and the design of the kiln and arise from firing process at temperatures above 1300 °C. These NO<sub>x</sub> emissions can be minimised by the operation of special low NO<sub>x</sub> burners. These burners are useful for reducing the flame temperature and thus reducing thermal and (to some extent) fuel derived NO<sub>x</sub>. The NO<sub>x</sub> reduction is achieved by supplying rinsing air for lowering the flame temperature or pulsed operation of the burners.

The combustion air coming via a burner into the kiln, the so-called 'primary air', is divided into two streams, the 'swirl air' and the 'axial air'. The axial air flows almost parallel towards to the burner axis whereas the swirl air has an axial and a tangential component. Both the swirl air and the axial air are necessary for the shape of the flame and to ensure the stability of the flame.

Low NO<sub>x</sub> burners are designed to reduce the primary air portion which leads to lower NO<sub>x</sub> formation whereas common multi-channel burners are operated with a primary air portion of 10 to 18 % of the total combustion air. The higher portion of the primary air leads to a short and intensive flame by the early mixing of hot secondary air and fuel. This results in high flame temperatures along with a creation of a high amount of NO<sub>x</sub> formation which can be avoided by using low NO<sub>x</sub> burners.

For the use of different types of waste, it is important to adjust the burner technique very well to the incinerated fuel, especially in the case of fuel changes or use of liquid waste fuels.

**Cross-media effects**

No issues.

**Operational data**

With an *annular shaft kiln*, positive experience has been gained with burners (30 – 150 kg/h fuel flowrate) atomising the fuel by high pressure air injection (6 bar). Additionally, the flowrate of combustion air and the shape of the flame are optimised. In 2005 and 2006, NO<sub>x</sub> emission levels of <200 mg/Nm<sup>3</sup> (standard state, 10 % oxygen) were measured. As the nitrogen and the water content of fuels may influence the NO<sub>x</sub> emission level, it has to be noted that heavy fuel oil was used as fuel [46, Germany, 2006], [157, Germany, 2007].

**Applicability**

Low NO<sub>x</sub> burners have been fitted to rotary kilns and can also be applied to annular shaft kilns for some specific conditions (high primary air). The direct transfer of the low NO<sub>x</sub> burner technique from cement kilns to lime kilns is not straightforward. In cement kilns, flame temperatures are higher and low NO<sub>x</sub> burners have been developed for reducing high initial levels of 'thermal NO<sub>x</sub>'. In most lime kilns, the levels of NO<sub>x</sub> are lower and the 'thermal NO<sub>x</sub>' is probably less important.

The burner technique has to be adjusted to the fuels used, i.e. conventional fossil or waste fuels. PFRKs have flameless combustion, thus rendering low NO<sub>x</sub> burners not applicable to this kiln type.

### Economics

The investment costs of low NO<sub>x</sub> burners are in the range of the costs for conventional burner techniques.

### Driving force for implementation

Legal requirements.

### Example plants and reference literature

German lime plant (annular shaft kiln).

[38, UK, 1996], [46, Germany, 2006], [54, EuLA, 2006], [157, Germany, 2007].

#### 2.4.6.1.4 Selective non-catalytic reduction (SNCR)

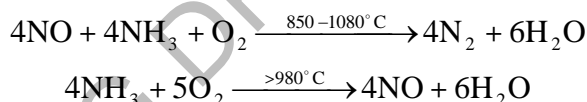
##### Description and achieved environmental benefits

In the selective non-catalytic reduction (SNCR) process, nitrogen oxides (NO and NO<sub>2</sub>) from the flue-gases are removed by selective non-catalytic reduction and converted into nitrogen and water by injecting a reducing agent into the kiln which reacts with the nitrogen oxides. Ammonia or urea is typically used as the reducing agent. The reactions occur at temperatures of between 850 and 1020 °C, with the optimal range typically between 900 to 920 °C.

A good mixing of the flue-gases and the reducing agent, an optimised injection temperature and a sufficient residence time in the window of optimal temperature is required. Because these conditions are not always easy to achieve during the technical processes for lime manufacture it is necessary to use an excess of the reducing agent to ensure the sufficient reduction efficiency.

However, too high NH<sub>3</sub>:NO ratios can lead to unwanted ammonia emissions, the so-called 'ammonia slip'. Since the flue-gases of lime kilns are usually not used, i.e. for drying materials, there is no possibility to further capture or adsorb the ammonia downstream. Thus ammonia slip can occur much easier in lime kilns than in other industrial processes.

The main reactions of the SNCR process and the temperature range for the injection of NH<sub>3</sub> are as follows:



Temperature is an important parameter. The reactions quoted above represent the main reactions among a multitude of other competing reactions. The first reaction shows the desired reduction of nitrogen oxides to nitrogen. The second describes the undesirable reaction where ammonia is oxidised. Usually this reaction takes place at a higher temperature and with a higher oxygen content at the injection location. Instead of liquid ammonia, liquid urea can be injected. The advantage of urea is that it is not hazardous and therefore much easier to handle.

##### Cross-media effects

Too high NH<sub>3</sub>:NO ratios can lead to ammonia emissions (ammonia slip).

Depending on the limited injection locations in lime kilns, a higher consumption of reducing agent becomes necessary to achieve the desired abatement levels. This again increases the risk of ammonia slip.

##### Operational data

Since July 2006 in the German lime industry, a trial with selective non-catalytic reduction (SNCR) is being carried out for the first time at one plant using fossil and waste fuels. Urea solution (45 %), 24.5 % ammonium hydroxide and ammonia containing waste water can be used as the reducing agent which are quality controlled to avoid unwanted substances. The reducing agent is injected in the grate preheater (Lepol grate). The choice of the injection place

(nozzles) is important for the efficiency and is the significant criterion for the best aeration of the waste gas, such as between kiln inlet and grate. The reaction temperature is in the range of 1080 to 1150 °C. Relations between temperature, NH<sub>3</sub> slip and NO<sub>x</sub> reduction are shown in Figure 2.50.

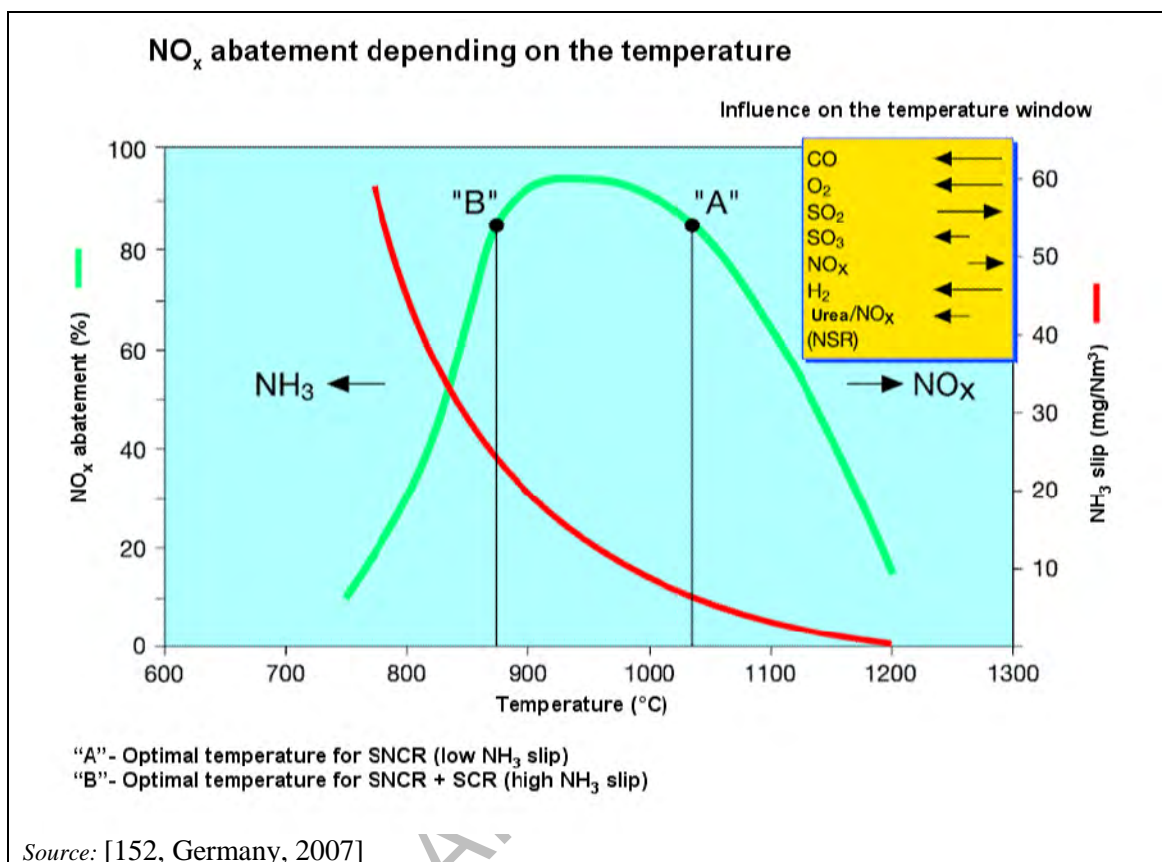


Figure 2.50: NO<sub>x</sub> abatement depending on the temperature

Theoretical operational data for the SNCR process used in the lime industry such as temperature window and reduction efficiency are shown in Table 2.39.

Process	Catalyser	Temperature window for the DeNO <sub>x</sub> reaction (°C)	NO <sub>x</sub> reduction efficiency (%)
SNCR	No catalytic converter NH <sub>3</sub> or (NH <sub>2</sub> ) <sub>2</sub> CO (urea) injected directly into the combustion chamber	850 – 1150	30 – 80

Source: [93, EuLA, 2006], [152, Germany, 2007]

Table 2.39: Theoretical operational data for the SNCR process

At an example plant in Flandersbach, Germany, it is possible to achieve reduction efficiencies of 50 to 70 %, thus enabling the level of NO<sub>x</sub> emissions to remain below 500 mg NO<sub>x</sub>/Nm<sup>3</sup> as a daily average (standard state, 10 % O<sub>2</sub>). Higher abatement ratios are, in principle, possible, but they lead immediately to massive ammonia slips. Measurements carried out under different process and injection conditions have shown that the emissions of nitrous oxide (N<sub>2</sub>O) always remain below 10 mg/Nm<sup>3</sup> [93, EuLA, 2006], [152, Germany, 2007].

### Applicability

In lime manufacturing, SNCR is applicable to preheater rotary kilns (Lepol grate).

For vertical kilns (which represent more than 90 % of the total amount of kilns in the EU-27), in 2007, it is technically not yet feasible to carry out an SNCR treatment since the temperature of the flue-gas is far below 200 °C.

In long rotary kilns, the application of the SNCR technique is not practical as the zone with the optimal window of temperatures is located within the rotating part of the kiln. In 2007, the access to this part of the kiln is not possible and only primary techniques are possible.

In preheater rotary kilns, theoretically, the process conditions allow the application of the SNCR technique, but only in some specific areas where the temperatures are in the ideal range of 950 to 1050 °C (conditions are not met by all PRKs, only by Lepol grate kilns). Thus, the possibilities to adjust and to optimise the injection location (so as to inject the reducing agent at the right temperatures and oxygen concentrations) are rather limited. Furthermore, a minimum residence time of the flue-gas in this temperature window is required in order:

- to evaporate the reducing agent (urea or liquid ammonia)
- to distribute it as homogeneously as possible over the whole section
- to let the reducing agent react with the nitrogen oxides.

In practice, both conditions are not necessarily met in preheater rotary kilns. Indeed for those equipped with vertical preheaters, the residence time of the flue-gas in the ideal temperature window is likely to be too short to enable the complete reaction with the nitrogen oxides over the whole section. For rotary kilns equipped with grate preheaters, the conditions are more easily fulfilled. However, practical experience also shows that the efficiency of the SNCR can be much lower than expected as shown in the following example from Germany, where DeNO<sub>x</sub> trials were carried out on a preheater kiln that was basically identical to the German kilns mentioned above (see operational data). The amount of urea injected above the Lepol grate had to be limited to a molar ratio NH<sub>2</sub>:NO<sub>2</sub> of 1:2 in order to limit the massive emissions of ammonia and ammonium salts at the stack. In fact, the test was stopped immediately after a white plume appeared at the stack. The continuous monitoring of the NO<sub>x</sub> emissions showed a slight decrease of the NO<sub>x</sub> emissions during the injection of urea from about 400 to approximately 300 mg/Nm<sup>3</sup>. Ammonia emissions arising from the kiln without urea injection were in the range of between 3 and 8 mg/Nm<sup>3</sup>, compared to less than 0.7 mg/Nm<sup>3</sup> as usually measured on rotary kilns. However, to apply SNCR to preheater rotary kilns with a Lepol grate, comprehensive testing phases and adaptations are needed and have to be carried out in advance.

### **Economics**

For the example plant in Flandersbach, Germany, investment costs were similar to those mentioned by the cement industry, i.e. between EUR 0.5 million and 1.2 million see Section 1.4.8.2). At this plant, the equipment was only in operation for a short period (few weeks) in 2007 and it is difficult to assess precisely the operating costs at the moment. Financial estimations based on the preliminary tests show that the operating costs could be similar to those reported by the cement industry, i.e. EUR 0.1 to 1.7 per tonne of lime referring to a kiln capacity of 1000 t/day and initial NO<sub>x</sub> emissions of up to 1500 mg/Nm<sup>3</sup>.

### **Driving force for implementation**

Legal requirements.

### **Example plants and reference literature**

Flandersbach lime plant, Germany.

[46, Germany, 2006] [54, EuLA, 2006], [57, European Commission, 2005], [93, EuLA, 2006],[152, Germany, 2007], [168, TWG CLM, 2007].



### 2.4.6.1.5 Selective catalytic reduction (SCR)

#### Description and achieved environmental benefits

The selective catalytic reduction technique (SCR) operates in a temperature range of between 300 – 400 °C. NO and NO<sub>2</sub> is reduced to N<sub>2</sub> by using NH<sub>3</sub> and a catalyst.

Irrespective of the type of reducing agent used, the SCR process requires a good mixing of the flue-gas and the agent, an optimised injection temperature and a sufficient residence time in the window of optimal temperatures. The use of a reducing agent ensures sufficient reduction efficiency. In general, SCRs can be operated nearly stoichiometrically and high reduction efficiencies will still be achieved. The flue-gases of lime kilns are usually not used, i.e. for drying materials. It is not possible to further capture or adsorb the ammonia downstream. See also Section 1.4.5.1.8.

#### Cross-media effects

The use of catalysts increase the operational costs and have to be recycled or disposed of.

In cases of high dust concentrations, electrical energy demand may increase due to the internal dedusting system of the SCR reactor and additional pressure losses.

Low dust exhaust gas systems require reheating the exhaust gases after dedusting, which may cause additional energy costs and pressure losses.

#### Operational data

Theoretical operational data, such as temperature ranges and reduction rates necessary for the use of this NO<sub>x</sub> reduction technique in the lime industry are shown in Table 2.40.

Process	Catalyser	Temperature window for the DeNO <sub>x</sub> reaction (°C)	NO <sub>x</sub> reduction efficiency (%)
SCR	Metal oxidised on ceramic bodies	280 – 450	70 – >90
	Molecular sieves	380 – 480	70 – 90

*Source: [93, EuLA, 2006]*

**Table 2.40: Theoretical temperature ranges and reduction rates necessary for the SCR process**

#### Applicability

Selective catalytic reduction can, in principle, be applicable for rotary lime kilns in order to reduce NO<sub>x</sub> emissions. However in 2007, the European lime industry did not have any experience with this technique for NO<sub>x</sub> reduction because SCR is not yet used.

Regarding the use of SCR in the lime industry, several parameters have to be investigated, e.g.:

- high dust charge
- high specific gas volume
- question on metal alkalis
- investment, operational and maintenance costs.

#### Economics

Cost data for SCR used in the cement industry are shown in Section 1.4.5.1.8 and Section 1.4.8.2.

#### Driving force for implementation

Legal requirements.

### Example plants and reference literature

In 2008, there were no example lime plants available in the EU-27. [54, EuLA, 2006], [168, TWG CLM, 2007].

#### 2.4.6.2 Reduction of SO<sub>2</sub> emissions

##### Description and achieved environmental benefits

SO<sub>2</sub> emissions, principally from rotary kilns, depend on the sulphur content of the fuel, the design of kiln and the required sulphur content of the lime produced. The selection of fuels with a low sulphur content can therefore limit the SO<sub>2</sub> emissions, and so can the production of lime using fuels with higher sulphur contents.

There are absorbent addition techniques for the reduction of SO<sub>2</sub> emissions available, such as cascade-type packed bed adsorbers, module adsorber systems, and dry flue-gas cleaning with a filter (fabric filter or electrostatic precipitator). The use of absorbents to reduce SO<sub>2</sub> emissions is well established in other industries; however, it has not yet been applied to rotary lime kilns. For the use in rotary kilns, the following techniques may be considered:

- use of fine limestone: At a straight rotary kiln fed with dolomite it has been observed that significant reductions in SO<sub>2</sub> emissions can occur with feedstones which either contain high levels of finely divided limestone or are prone to break up on heating. The finely divided limestone calcines, is entrained in the kiln gases and removes SO<sub>2</sub> en route to, and in, the dust collector
- lime injection into the combustion air: A patented technique (EP 0 734 755 A1) describes the reduction of SO<sub>2</sub> emissions from rotary kilns by injecting finely divided quick or hydrated lime into the air fed into the firing hood of the kiln
- injection of an absorbent into the exhaust gases: A recognised technique for reducing SO<sub>2</sub> concentrations in gaseous emissions is to:
  - inject an absorbent (e.g. hydrated lime or sodium bicarbonate) into the gas stream, and
  - provide sufficient gas residence time between the injection point and the dust collector (preferably a fabric filter) to obtain efficient absorption.

In 2007, there were no abatement techniques installed in any European plants. However, in some cases, injection of hydrated lime is used to reduce SO<sub>2</sub> emissions [54, EuLA, 2006].

In this context, useful information about sorption plants can be found in the Reference Document on Best Available Techniques on Common Waste Water and Waste Gas Treatment/Management Systems in the Chemical Sector [58, European Commission, 2003].

##### Cross-media effects

No data available.

##### Operational data

Test measurement results show that, except from a few long rotary kilns, of which there are fewer than 26 in the EU-27, the majority of lime kilns (PFRK, ASK, MFSK, OSK, PRK) achieve less than 50 mg/Nm<sup>3</sup>, due to the natural propensity of lime to capture sulphur (see Section 2.3.3.3). Furthermore, by using waste as fuel, the majority of lime kilns can achieve less than 50 mg/Nm<sup>3</sup>.

##### Applicability

Absorbent addition techniques for the reduction of SO<sub>2</sub> emissions can, in principle, be applied in the lime industry. However in 2007, they were not applied.

The techniques described above may merit further investigation so that they can be adapted for use for rotary lime kilns.

**Economics**

No data available.

**Driving force for implementation**

Legal requirements.

**Example plants and reference literature**

Lime plants in the EU-27.

[54, EuLA, 2006], [168, TWG CLM, 2007], [182, TWG CLM, 2008].

**2.4.6.3 Reduction of CO emissions****Description**

The selection, when possible, of raw materials with a low content of organic matter also reduces the emissions of CO. However, raw material selection depends on the kiln type used and/or the type of lime produced, e.g. hydraulic lime production.

*CO trip management*

During elevated CO levels in the flue-gases, ESPs will have to be shutdown for safety reasons.

The CO trip management technique being developed for cement kilns fitted with electrostatic precipitators (ESPs) may be applicable in some circumstances to rotary lime kilns equipped with ESPs. However, the rate of dust emissions (kg/tonne of product) following the deactivation of the ESP is generally very much lower in the case of lime kilns than in that of cement kilns, owing to the relatively coarse size of the limestone and the absence of any dust recycling.

Information regarding the control of CO trips and a guideline can be found in Section 1.4.5.3 and in Section 6.2.6.

**Achieved environmental benefits**

Reduction of CO trips, CO and dust emissions.

**Cross-media effects**

CO trips can lead to explosions in the ESPs.

**Operational data**

CO emissions in the range of <100 – <500 mg/Nm<sup>3</sup> (spot test results) have been reported from PFRKs, LRKs, PRKs, OSKs (see Table 2.38 in Section 2.3.3.4.2). For ASKs and MFSKs higher CO emission levels will be necessary for technical reasons.

In the special case of hydraulic lime production, the organic carbon content of raw material is typically in the range of 0.8 – 5 %.

**Applicability**

CO trip management can, in principle, be applied to rotary kilns.

**Economics**

No data available.

**Driving force for implementation**

Legal requirements.

### **Example plants and reference literature**

Lime plants in the EU-27.

[54, EuLA, 2006], [83, CEMBUREAU, 2006], [168, TWG CLM, 2007], [182, TWG CLM, 2008].

#### **2.4.6.4 Reduction of total organic carbon emissions (TOC)**

##### **Description and achieved environmental benefits**

VOC emissions are typically measured as total organic carbon (TOC) and they are often related to emissions of CO, resulting from incomplete fuel combustion. Because the operator tends to limit the CO emissions of the kilns, the VOC emissions remain generally low. Optimisation of the process, such as smoothing and optimising the plant's operation, the firing process and/or homogenisation of the fuel and raw material feedings, can be applied for keeping TOC emissions low.

##### **Cross-media effects**

No issues.

##### **Operational data**

In a very limited number of cases where the raw material limestone contains organic matter of up to 0.1 %, volatile organic compounds can be emitted continuously.

For ASKs, LRKs and PRKs, VOC emissions only occur for short periods during start-up, or upset conditions thus leading to emissions of below 10 mg/Nm<sup>3</sup> (eqC). For PFRKs, the process entails cyclic changes of combustion conditions every 10 to 12 minutes. Therefore, the levels of VOC emissions are slightly above the ones observed for other types of kilns.

Raw materials used for hydraulic lime production contain high organic matter in a typical range of 0.8 – 5 % (expressed as TOC) which lead to higher TOC emissions than those for conventional lime production.

##### **Applicability**

These techniques are, in principle, applicable to lime kilns.

##### **Economics**

No data available.

##### **Driving force for implementation**

Legal requirements.

### **Example plants and reference literature**

Lime plants in the EU-27.

[129, EuLA, 2006], [182, TWG CLM, 2008].

#### **2.4.6.5 Reduction of hydrogen chloride (HCl) and hydrogen fluoride (HF)**

##### **Description and achieved environmental benefits**

The use of fuels containing low chlorine and low fluorine levels can reduce chlorine and fluorine emissions. Most of the chlorine which is present in the raw materials and fuels is captured by the quicklime.

In vertical kilns, the efficient contact between the kiln gases and the lime/dolime ensures efficient absorption of HCl. However, HCl emissions from shaft kilns mainly depend on the chlorine compounds in the limestone. When burning dry limestone, HCl emissions tend to be higher. In some cases, HCl emissions may be reduced by injecting water into the flue-gas.

**Cross-media effects**

No issues.

**Operational data**

The chlorine content is higher in dolomite (100 to about 1000 ppm) than in limestone (10 to 150 ppm).

For the use of wastes as fuels, HCl emissions of 10 mg/Nm<sup>3</sup> and HF emissions of 1 mg/Nm<sup>3</sup> were reported (see Table 2.27 in Section 2.3.3.7).

**Applicability**

These techniques are, in principle, applicable in the lime industry.

**Economics**

No data available.

**Driving force for implementation**

Legal requirements.

Local conditions.

**Example plants and reference literature**

Lime plants in the EU-27.

[46, Germany, 2006], [182, TWG CLM, 2008].

## 2.4.7 Reduction of polychlorinated dibenzo-p-dioxins (PCDD) and polychlorinated dibenzofurans (PCDF) emissions

**Description and achieved environmental benefits**

Raw materials or fuels that contain chlorides can potentially cause the formation of PCDD and PCDF in any of the process zones where the temperatures range from 300 to 450 °C.

If waste is used as fuel, the content of chlorine in fuels as well as the emissions may increase.

From relevant literature on lime production, the following key rules concerning the formation of PCDD/F are known:

- limit the residence time of flue-gases in zones where the temperature range from 300 to 450 °C
- limit the oxygen content in these same zones
- limit the copper input through the fuel because of its catalytic properties in the synthesis of PCDD/F.

Based on these rules, an action plan could be envisaged according to the flow diagram shown in Figure 2.51 and Figure 2.52.

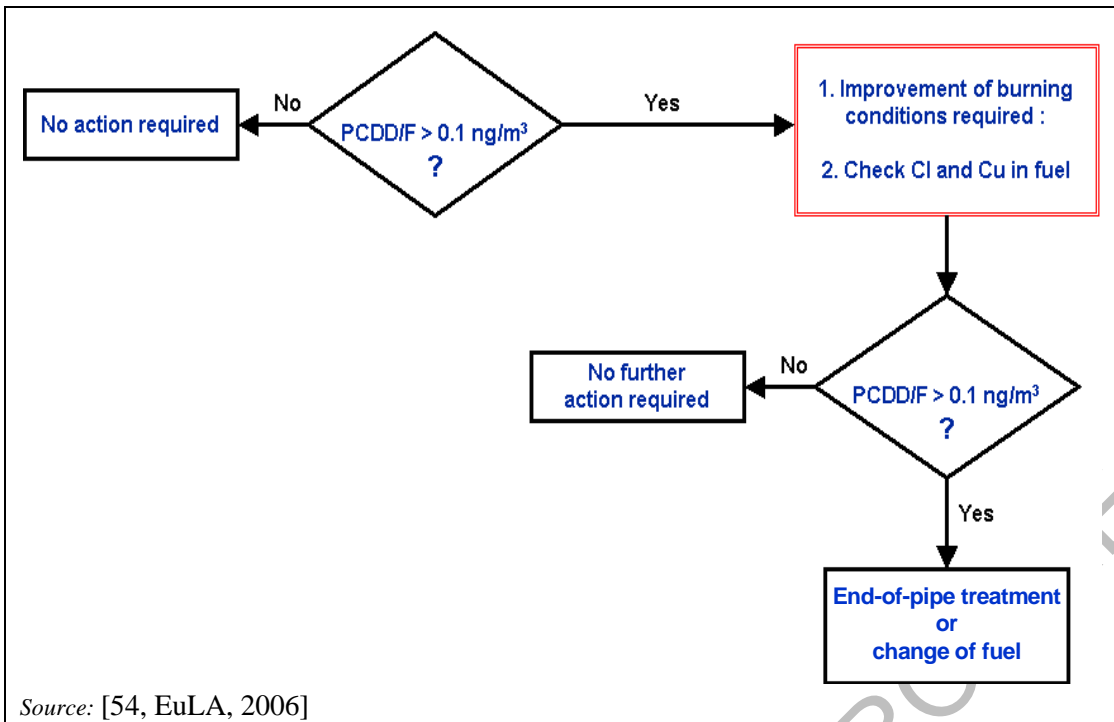
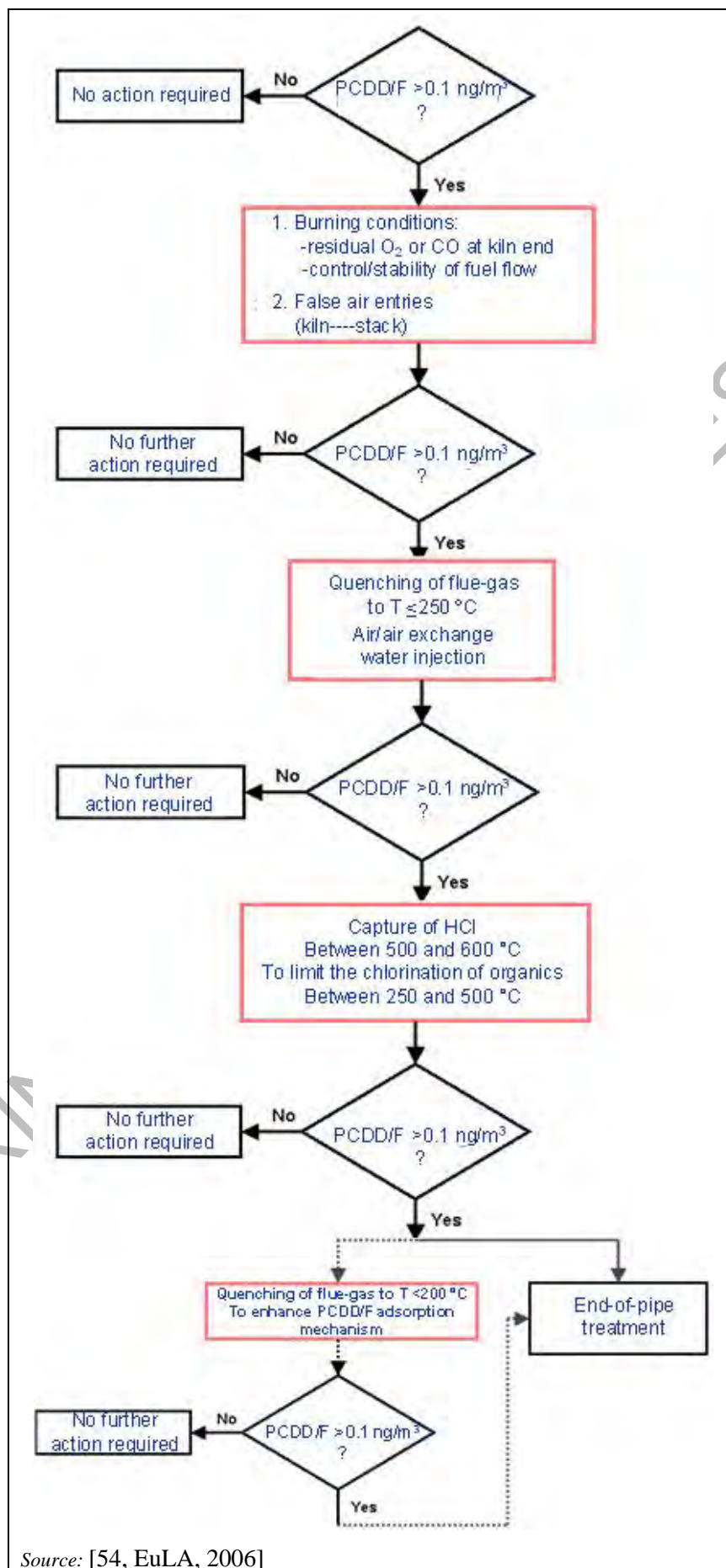


Figure 2.51: Flow diagram for the PCDD/F emissions in vertical lime kilns



Source: [54, EuLA, 2006]

Figure 2.52: Flow diagram for the PCDD/F emissions in rotary kilns (LRK, RPK)

### **Cross-media effects**

The use of wastes may influence the content of chlorine in fuels and the emissions may increase.

### **Operational data**

PCDD/F emissions data in a range of between 0.005 and 0.07 ng I-TEQ/Nm<sup>3</sup> were reported from different types of lime kilns (see Section 2.3.3.6). As far as has been observed from the data provided, the measured average emissions of PCDD for all types of lime kilns in the EU-27 are less than 0.1 ng I-TEQ/Nm<sup>3</sup>. This emission value is relevant when using wastes as fuels for the process. When co-incinerating waste, the requirements of **Chapter IV of and Annex VI to the Directive 2010/75/EU** have to be met.

However, investigations are ongoing so as to improve the understanding of PCDD formation in lime kilns in order to ensure that in the future, the emissions will always remain below 0.1 ng I-TEQ/Nm<sup>3</sup> when using fuels with a higher chlorine content.

### **Applicability**

These techniques can, in principle, be applied at lime kilns. Waste fuels are analysed before they are used.

### **Economics**

No data available.

### **Driving force for implementation**

Legal requirements.

### **Example plants and reference literature**

Lime plants in the EU-27.  
[54, EuLA, 2006], [182, TWG CLM, 2008].

## **2.4.8 Reduction of metal emissions**

### **Description and achieved environmental benefits**

Feeding fuels with a high content of metals into the kiln system should be avoided. Furthermore, the use of materials with a high content of volatile metals, such as Hg and Tl, should especially be controlled.

Careful selection and guaranteed characteristics of substances entering the kiln can reduce emissions, e.g. using a quality assurance system to guarantee the characteristics of the waste fuels used (see Section 2.4.4). Furthermore, special attention has to be given to mercury. Because of the volatility of mercury, relevant higher levels of mercury emissions may occur. Therefore, the mercury input via waste fuels has to be controlled and, if necessary, limited (see Section 2.3.3.10).

An effective dust removal reduces metal emissions because the emitted metals (except part of the mercury) are, to a large extent, bound to dust. Furthermore, absorption on activated carbon is an option.

### **Cross-media effects**

Dust removal devices increase the consumption of electrical energy due to a higher pressure loss.

### **Operational data**

As shown in Table 2.28 (see Section 2.3.3.9), metal emission values are within a range of 0.01 – 0.1 mg/Nm<sup>3</sup>. For lead and zinc, in some specific cases with higher dust emissions, values of up to 0.40 mg/Nm<sup>3</sup> can be observed.



For the use of waste, the measured emissions for mercury were observed to be below 0.03 mg/Nm<sup>3</sup> measured as a daily average value, or 0.05 mg/Nm<sup>3</sup> measured as a half hourly average value. For cadmium and thallium together, the measured emissions were observed to be below 0.05 mg/Nm<sup>3</sup> measured as a half hourly average value, and for the sum of arsenic, cobalt, chromium, copper, manganese, lead, antimony, tin and vanadium, the measured emissions were observed to be below 0.5 mg/Nm<sup>3</sup> measured as a half hourly average value (oxygen content 10 %) (see Section 2.3.3.10.1) [46, Germany, 2006].

### **Applicability**

This measure/technique can be applied in the lime industry.

### **Economics**

An effective dust removal can avoid high costs for activated carbon filters.

A required quality assurance system to guarantee the characteristics of materials fed to the kiln may result in additional costs.

### **Driving force for implementation**

Legal requirements.

### **Example plants and reference literature**

Lime plants in the EU-27.

[46, Germany, 2006], [51, EuLA, 2006], [54, EuLA, 2006], [168, TWG CLM, 2007], [182, TWG CLM, 2008].

## **2.4.9 Process losses/waste**

### **2.4.9.1 General considerations concerning re-use of solid process losses/waste as raw material**

This section deals with possibilities for the reduction of solid waste occurring in the several steps during the lime manufacturing processes.

Dust collected while loading, unloading, conveying, mechanically handling and processing raw materials can normally be re-used as raw material. For instance, in the storage of raw materials, any filter dust can be fed back directly to the production process or to the silo, when local air cleaning by a silo top-filter is used.

The separated dust collected from fabric filters of grinding plants, screening/sieving plants, grinding mills, hydrate plants or loading is burned lime that can be mixed with the product or is re-used in cement plants, especially when cement and lime plants are located on one site [66, Austria, 2006].

Dust originating from a flue-gas cleaning system can be re-used only under certain circumstances, because this dust can contain pollutants, such as high concentrations of sulphur, fluorine and metals, especially when waste is co-incinerated. In most cases, the collected dust is principally calcium carbonate, with varying amounts of calcium oxide, fuel ash and clay. The uses for the collected dust range from incorporation into commercial products (for example, building lime, lime for soil stabilisation, hydrated lime and pelletised products) to landfill.

The collected suspension generated during flue-gas cleaning by using wet scrubbers, is settled, the liquor is generally recycled and the wet solids are, in most cases, landfilled. Therefore, a separate conduction of different off-gas streams facilitates the optimal utilisation of dusty process losses. Gypsum generated during flue-gas cleaning, cannot be re-used in the lime production process, but is used in the cement industry as a hardening regulator.

Materials which cannot be recycled internally leave the plant to be used in other industries or to be supplied to external waste recycling or waste disposal facilities.

### 2.4.10 Noise

#### **Description and achieved environmental benefits**

This section deals with possibilities for the reduction of noise occurring in the several steps during the lime manufacturing processes. Noise abatement is of particular importance, as lime plants are often situated close to residential areas.

A reduction of noise emissions can often be achieved by directly applying techniques at the source of the noise. Sources of noise are, for example, extraction and processing of limestone as well as lime production inevitably crushing units, grinding and preparation units, the lime kilns themselves, the feeding systems kilns, belt conveyors, filter units, the cooling systems of the kilns, etc.

Various techniques for noise abatement can be applied at lime plants in order to reduce the noise levels for neighbourhood protection. The most effective combination of techniques has to be identified individually for each plant or production site.

The following technical techniques are applied in the lime industry:

- appropriate choice of location for noisy operations
- enclosure of noisy operations, e.g. kiln feeding, lime discharge, product shipping
- installation of noise barriers and building up noise protection walls, e.g. at the dumper loading facility
- using internal and external lining made of resistant material for chutes
- soundproofing buildings to shelter any operations involving material transformation equipment
- sound insulation of machine buildings
- sound insulation of wall breaks, e.g. by installation of a sluice at the entrance point of a belt conveyor
- installation of sound absorbers at air outlets, e.g. the clean gas outlet of dedusting units
- reduction of flowrates in ducts
- sound insulation of ducts
- outlet silencers for exhaust stacks
- lagging of ducts and finally blowers which are situated in soundproofed buildings
- decoupled arrangement of noise sources and potentially resonant components, e.g. of compressors and ducts.

Existing or older plants are upgraded to comply with the national legislation requirements and the older designs may create difficulties such as lack of space to place linings, access for maintenance to be thought about, etc.

If the above-mentioned noise protection techniques cannot be applied and if a transfer of noisy units inside a building is not possible, e.g. because of the sizes of kilns and their facilities, secondary noise protection techniques, e.g. constructing of buildings or growing trees and bushes between the protected area and the noisy activity, e.g. the kiln or the storage area, have to be carried out. Doors and windows of covered areas have to keep closed during noisy operations.

### *Noise abatement schemes*

A practice for reducing noise emissions from lime plants is to develop a noise abatement scheme for the whole site, taking into account all noise sources at the production site, noise abatement costs, legal requirements as well as neighbourhood concerns.

The most effective noise abatement scheme does not necessarily include noise reduction techniques at the loudest unit, because noise levels decrease significantly with distance to the source. Accordingly, a combination of techniques at noise sources close to the affected areas may be more efficient. In some cases organisational techniques, such as reducing night time activities, may be sufficient to reduce nuisances for the neighbourhood and to comply with legal requirements.

Development of a noise abatement scheme usually includes the following steps:

- listing all major sound sources and determining their sound pressure levels
- determination of the affected areas, e.g. housing areas
- computer-based calculation of the noise propagation (based on three-dimensional modelling of the site and its surroundings)
- ranking of the noise sources according to their relevance for individual affected areas (separately for day and night time)
- evaluation of noise abatement techniques with regard to their relevance for the noise level in affected areas and estimated costs
- identification of the most cost-effective combination of techniques that ensures compliance with the legal requirements as well as acceptance in the neighbourhood [46, Germany, 2006]

#### **Cross-media effects**

Additional investment and maintenance costs can occur due to the noise protection techniques.

#### **Operational data**

No data available.

#### **Applicability**

Techniques for noise reduction can, in principle, be applicable in the cement industry (see Section 2.3.6).

#### **Economics**

Additional investment costs can occur due to the noise protection techniques.

#### **Driving force for implementation**

Legal requirements.

#### **Example plants and reference literature**

Lime plants in Germany, lime plants in the EU-27.  
[46, Germany, 2006].

### 2.4.11 General considerations for odours

Odours can occur in lime plants using mixed feed shaft kilns because of the hydrogen sulphide (H<sub>2</sub>S) emissions produced. This depends on the part of the reduced or elemental forms of sulphur which can lead to H<sub>2</sub>S emissions. The use of a regenerative afterburner in order to reduce the H<sub>2</sub>S in the flue-gas stream can be successful. In 2008 in Europe, only one lime plant was equipped with a thermal afterburner to reduce H<sub>2</sub>S emissions; however, this was only for a 6 months working period. No further regenerative afterburners are operational in the European lime industry.

Reducing the sulphur content in the fuels may be possible for reducing odour emissions.

Odours can also be caused by wastes which are used as fuels. Storages of waste materials can be covered or waste storage systems can be used.

### 2.4.12 Environmental management tools

Environmental management tools are described in the cement chapter in Section 1.4.12 of this document.

**\*\*NOTE to Article 13 Forum members: Section 2.5 that included the BAT conclusions have been deleted and replaced by Chapter 4\*\***

## 2.5 Emerging techniques in the lime industry

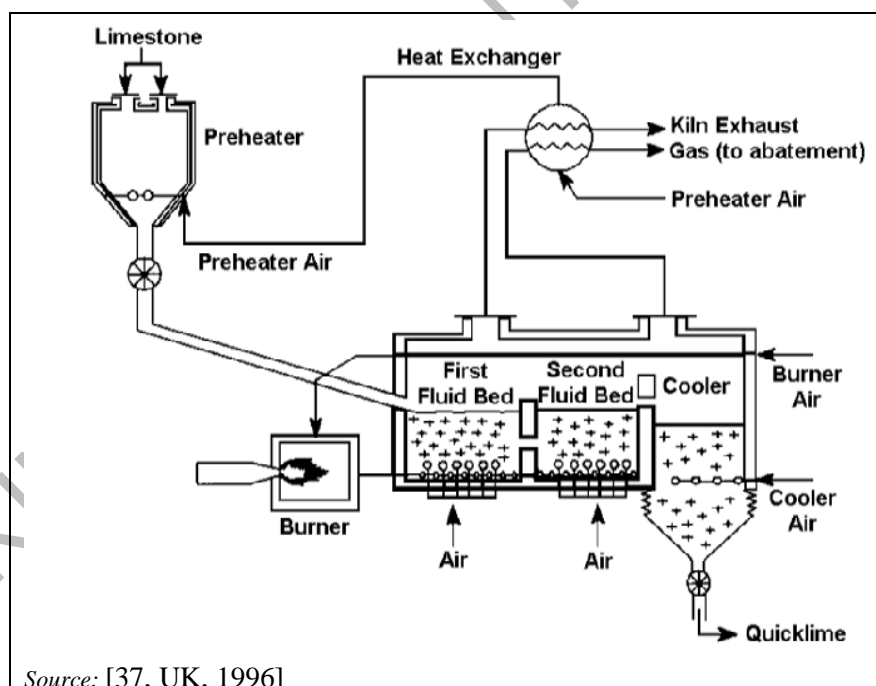
### 2.5.1 Fluidised bed calcination

The calcination of finely divided limestone in a fluidised bed has been practised on a relatively small scale for many years. It has several potential advantages, including:

- the use of surplus grades of fine limestone
- low NO<sub>x</sub> emissions, and
- low SO<sub>2</sub> emissions, when using high sulphur fuels.

However, the technique does not have a particularly low specific heat use, the finely divided products are not suitable for many applications and the residual calcium carbonate level is relatively high. Initial problems with using the technique for kilns with productive capacities in excess of 150 tonnes per day appear to have been resolved.

Figure 2.53 shows a schematic diagram of a fluidised bed kiln. Fine limestone is fed to a preheater vessel using air heated by the kiln exhaust gas via a heat exchanger. The preheated limestone then enters the first fluidised bed vessel where the temperature is increased and limestone starts to be calcined. As the limestone is calcined, the lighter quicklime flows over the weir wall into the next fluidised bed vessel where calcination is completed. The quicklime then passes through the cooler where it is cooled by ambient air.



Source: [37, UK, 1996]

Figure 2.53: Fluidised bed kiln

Although fluidised bed technique may offer lower pollutant releases than other lime kiln technique, it is not well proven and can only produce fine lime with a high reactivity.

### 2.5.2 Flash calciner/suspension preheater

The technique of feeding finely divided limestone via a suspension preheater into a flash calciner was developed in the cement industry. However, it is only suitable for a limited range of limestone qualities and has been used in a very small number of installations. Two kilns in

Australia are in operation using this technique. In one, the product from the flash calciner is passed through a short rotary kiln. The rotary section is designed to control the %  $\text{CaCO}_3$  and the reactivity of the lime within customer specifications.

The technique is particularly suitable for 'sandy' limestone as the flash calciner kiln accepts feedstone in the 0 – 2 mm range. It is understood to have high capital costs, which are likely to restrict its use to relatively large output levels (for example, about 500 tonnes/day).

### 2.5.3 Ceramic filters

Ceramic filters are not used on lime kilns in 2008. However, they are able to remove dust efficiently from gases at very high temperatures, and it is possible that, with kilns such as rotary kilns producing dead burned dolomite, dedusting high temperature gases might enable certain heat recovery systems to become viable.

### 2.5.4 Post-combustion of flue-gases from mixed feed shaft kilns

For the treatment of the flue-gases from mixed feed shaft kilns, two main abatement techniques can be considered:

- the recuperative thermal oxidiser:

The main technical advantage of this technique is its relatively low sensitivity to dust concentrations of up to  $30 \text{ mg/Nm}^3$ . In addition, ammonium salts which lead to clogging and corrosion issues cannot form because of the high temperatures existing in the oxidiser. However, even under the best operation at conditions, this technique requires a significant input of additional energy (up to  $0.85 \text{ GJ/t}$  output). Practical experience about pollutant abatement efficiency and operating costs of such equipment were not available in the lime industry in 2008

- the regenerative thermal oxidiser:

Pilot tests using a small regenerative oxidiser have been carried out at several plants equipped with mixed feed shaft kilns burning different solid fuels. The oxidiser was installed between the fabric filter and the stack in a partial flue-gas (flue-gas stream:  $Q < 1500 \text{ Nm}^3/\text{h}$ ), separated from the main flue-gas stream as shown in Figure 2.54.

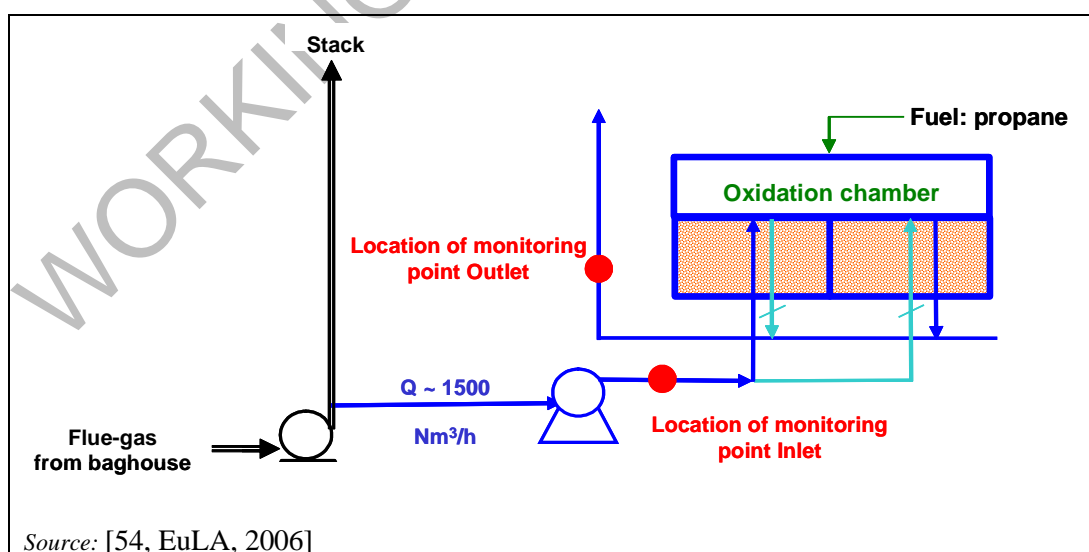


Figure 2.54: Example flow diagram of a post-combustion technique

The compositions of the flue-gas at the inlet and at the outlet of the oxidiser were closely monitored over several hours. The main results of these tests are summarised and shown in Table 2.37.

	Substance	Average inlet concentration (dry) (mg/Nm <sup>3</sup> )	Average outlet concentration (dry) (mg/Nm <sup>3</sup> )
Case 1	CO	4900	35
	TOC	32	0.1
	H <sub>2</sub> S	<0.8	<0.7
Case 2	CO	14 650	95
	TOC	120	0.4
	H <sub>2</sub> S	2	<0.8
Case 3	CO	6270	51
	TOC	338	1.3
	H <sub>2</sub> S	1.4	<1.2
Case 4	CO	10810	95
	TOC	37	0.2
	H <sub>2</sub> S	/	/
Case 5	CO	14 230	128
	TOC	34	0.3
	H <sub>2</sub> S	20	<0.9
Case 6	CO	14450	115
	TOC	53	0.5
	H <sub>2</sub> S	33	<0.5

*Source:* [54, EuLA, 2006]

**Table 2.41: Flue-gas composition monitored over several hours**

From these tests it can be concluded that, if well designed, the oxidiser can run and operate in auto thermal conditions (i.e. without the need of additional energy) if the CO concentration exceeds a range of 1.5 to 2 % in the flue-gas before treatment. In this case, the abatement efficiency of generally 98 % can be achieved for carbon monoxide, TOC and hydrogen sulphide. The CO emissions concentration in the clean gas is always <100 mg/Nm<sup>3</sup> [142, EnvNGO/Tebert, 2007]. However, and on the contrary to the recuperative system, this equipment requires very low dust concentrations in the flue-gas (generally below 5 mg/Nm<sup>3</sup>). If temperatures at the outlet are too low (e.g. below 200 °C), ammonium salts can be formed. Corrosion of pipes and/or uncontrolled emissions of dust can then be expected. The tests have also shown that, if the CO levels exceed a range of 2 to 3 %, too much energy is generated in the oxidiser by the oxidation of the pollutants. This can lead to serious trouble during the daily operation of the equipment.

The decision about the technique which should be used needs to be based on the following (non exhaustive) list of criteria:

- characteristics of the flue-gas (e.g. flowrate, oxygen, carbon monoxide and TOC contents, temperature)
- variability of these parameters over time
- characteristics of the dedusting system.

Therefore, the best solution depends on the local conditions [54, EuLA, 2006].

**\*\*NOTE to Article 13 Forum members: Section 2.7 of the CLM BREF has been moved to Chapter 5 – Concluding remarks and recommendations for future work\*\***

WORKING DRAFT IN PROGRESS



## 3 MAGNESIUM OXIDE INDUSTRY (DRY PROCESS ROUTE BASED ON MINED NATURAL MAGNESITE)

### 3.1 General Information

#### 3.1.1 Introduction

Magnesium oxide is the most important industrial magnesium compound with its main application in the steel and refractory industry. It is also largely used in many other industrial sectors including the food and animal feed industries. The raw materials for the production of magnesium oxide are both natural magnesium carbonate and brucite or magnesium chloride from seawater and brines.

For the production of magnesium oxide (MgO/magnesia), two general production process routes are used:

- starting from magnesium carbonate, by a high temperature decarbonisation reaction, magnesium carbonate itself may be obtained from magnesite mines (natural or dry process route)
- starting from magnesium chloride, through various processes like the high temperature hydrolysis reaction and magnesium hydroxide ( $\text{Mg}(\text{OH})_2$ ) precipitation. Magnesium chloride may be obtained from brines, the dissolution of magnesium rich minerals with hydrochloric acid (HCl) and seawater (synthetic or wet process route) [108, European Commission, 2006].

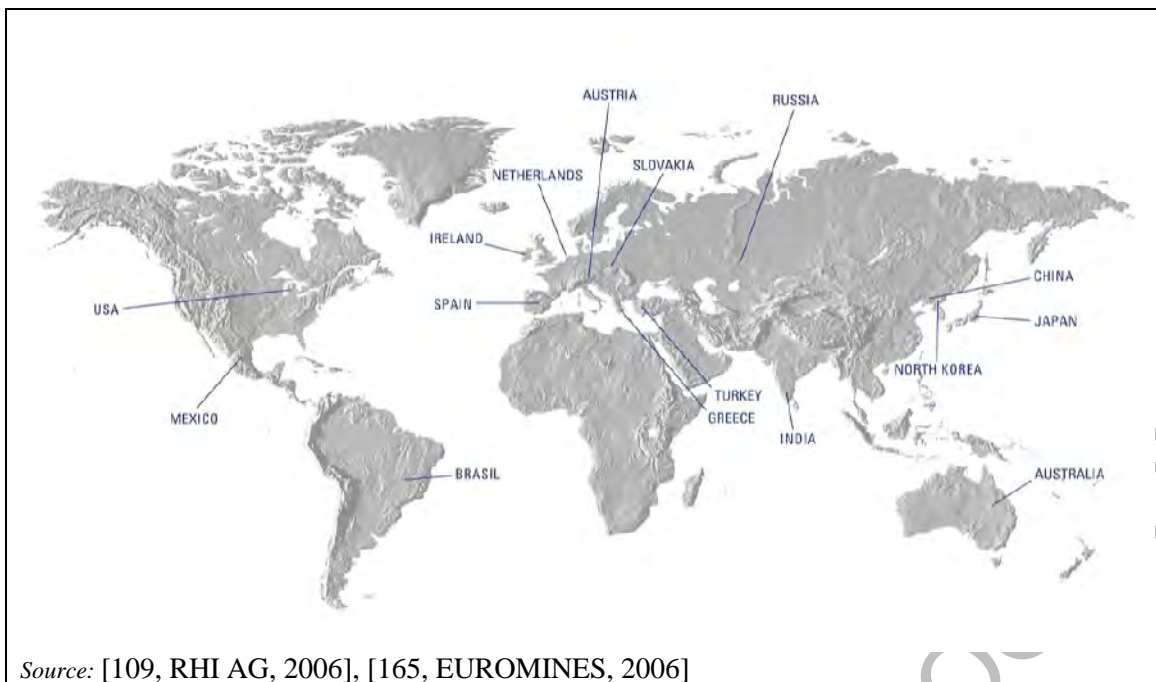
The use of the process route starting from magnesium chloride mentioned above (wet process route) is decreasing because the energy requirements are three times higher than those of the magnesium oxide production process starting from magnesium carbonate (dry process route). More information regarding the wet process route can be found in the Reference Document on Best Available Technique for the Manufacture of Large Volume Inorganic Chemicals – Solids and Others Industry (LVIC – S) where this wet process for the production of magnesium oxide is described [108, European Commission, 2006].

This chapter covers the production of magnesium oxide (MgO/magnesia) of which there are different types – DBM, CCM, FM (see Section 3.1.2.1.1) – by using the dry process route based on mined natural magnesite (magnesium carbonate  $\text{MgCO}_3$ ). In Europe, brucite is not used for the production of magnesium oxide; however, the production steps and burning conditions required are exactly the same. The wet process route using magnesium chloride as the starting material is not covered within this document because of the differences in the use of process structure, techniques and raw materials.

However, in some cases such as for market reasons, these two magnesia products cannot be separated. If these cases occur, an appropriate remark is given in this document.

#### 3.1.2 The magnesite industry worldwide and in Europe

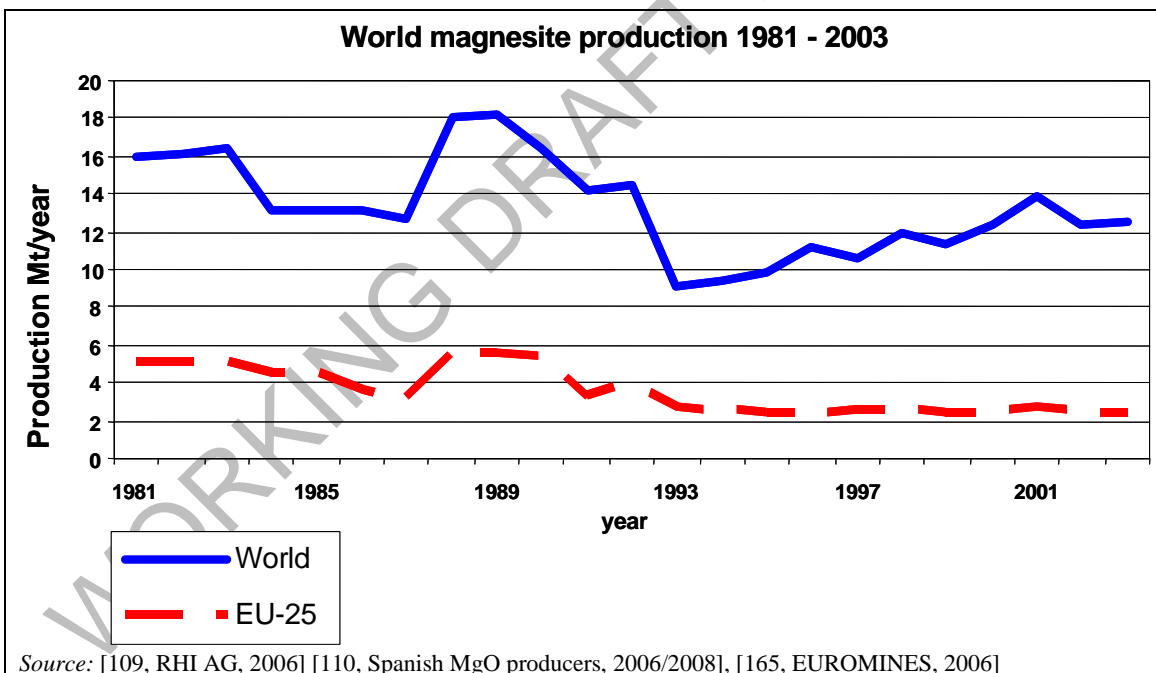
Sintered or dead burned magnesia (DBM) is produced and traded worldwide along with caustic calcined (CCM) and fused magnesia (FM). Figure 3.1 gives an overview of the worldwide sources and the producers of magnesium oxide.



Source: [109, RHI AG, 2006], [165, EUROMINES, 2006]

Figure 3.1: Global sources of magnesium oxide and producer countries

Figure 3.2 shows the worldwide raw magnesite production figures and production figures for the EU-25 using the dry process route from 1981 until 2003.



Source: [109, RHI AG, 2006] [110, Spanish MgO producers, 2006/2008], [165, EUROMINES, 2006]

Figure 3.2: Raw magnesite production in the EU-25 and worldwide

Table 3.1 shows this worldwide production data from 2000 to 2005 related to the producer countries.

Country	Raw magnesite production (t)					
	2000	2001	2002	2003	2004	2005
Albania <sup>(1)</sup>	n.a.	n.a.	n.a.	n.a.	n.a.	n.a.
Australia	349933	540000	540000	553847	586393	590000
Austria	725832	680534	728235	766525	715459	693754
Brazil	300000	265749	310000	330000	350000	386759
Canada	270000	300000	200000	150000	140000	120000
China	4230000	4300000	4400000	4500000	4650000	4800000
CIS – Asia	250000	260000	150000	120000	n.a.	n.a.
CIS – Europe	2250000	2340000	1350000	1080000	n.a.	n.a.
Columbia	7100	7000	6900	6700	6500	6300
Czech Republic <sup>(2)</sup>	n.a.	n.a.	n.a.	n.a.	n.a.	n.a.
DPR Korea	650000	650000	450000	580000	n.a.	n.a.
Greece	492780	483296	558057	549049	499474	500000
Guatemala <sup>(3)</sup>	n.a.	n.a.	n.a.	n.a.	n.a.	n.a.
India	340000	330000	280000	300000	320000	380000
Iran	140000	133778	128565	91700	91700	120000
Kenya <sup>(4)</sup>	n.a.	n.a.	n.a.	n.a.	n.a.	n.a.
Korea	650000	650000	450000	580000	600000	800000
Mexico <sup>(5)</sup>	n.a.	n.a.	n.a.	n.a.	n.a.	n.a.
Nepal <sup>(6)</sup>	n.a.	n.a.	n.a.	n.a.	n.a.	n.a.
Pakistan	3610	3000	4430	4700	4900	3029
Philippines <sup>(7)</sup>	n.a.	n.a.	n.a.	n.a.	n.a.	n.a.
Poland	54830	23000	24000	33000	35000	37000
Russia (Europe)	1400000	1380000	1350000	1080000	900000	885000
Russia (Asia)	140000	138000	150000	120000	100000	95000
Serbia and Montenegro	0	0	0	73000	70000	60000
Slovakia	1535200	1537000	1464500	1640900	965900	1555000
South Africa	97446	98000	99000	100000	120000	130000
Spain	423605	438194	462200	468900	n.a.	n.a.
Thailand <sup>(8)</sup>	n.a.	n.a.	n.a.	n.a.	n.a.	n.a.
Turkey	2672089	2738086	2800000	3224278	n.a.	n.a.
USSR <sup>(9)</sup>	n.a.	n.a.	n.a.	n.a.	n.a.	n.a.
US <sup>(10)</sup>	n.a.	n.a.	n.a.	n.a.	n.a.	n.a.
Yugoslavia	80000	78000	75000	73000	0	0
Zimbabwe	5800	6000	6200	6400	6500	6800

For different countries, data are only available within the following periods:

<sup>(1)</sup> Data available from 1988 – 1994

<sup>(2)</sup> Data available from 1981 – 1994

<sup>(3)</sup> Data available from 1984 – 1992

<sup>(4)</sup> Data available from 1984 – 1992

<sup>(5)</sup> Data available from 1988 – 1994

<sup>(6)</sup> Data available from 1983 – 1992

<sup>(7)</sup> Data available from 1984 – 1994

<sup>(8)</sup> Data available from 1988 – 1992

<sup>(9)</sup> Data available from 1981 – 1994

<sup>(10)</sup> Data available from 1981 – 1983

n.a.: no data available

Source: [109, RHI AG, 2006], [110, Spanish MgO producers, 2006/2008], [165, EUROMINES, 2006], [168, TWG CLM, 2007]

**Table 3.1: Worldwide production of raw magnesite (magnesium carbonate) from 2000 to 2005**

The world's production of magnesite was around 12.5 million tonnes in 2003. In the EU-27, about 2.3 million tonnes were produced in 2003 which was 18.4 % of the world's production. In 2003, the world's production of magnesium oxide (magnesia) by using the dry process route was around 5.8 million tonnes. In comparison to 1981, when the countries in Europe were still responsible for 32 % of the world's production, this share between world's production and EU production significantly decreased. Therefore in 1995 and 2005, the European Commission published Council Regulations on protection against dumped imports from countries not members of the European Community and imposed a definitive anti-dumping duty on imports of magnesium oxide [166, European Union, 1995], [167, European Union, 2005].

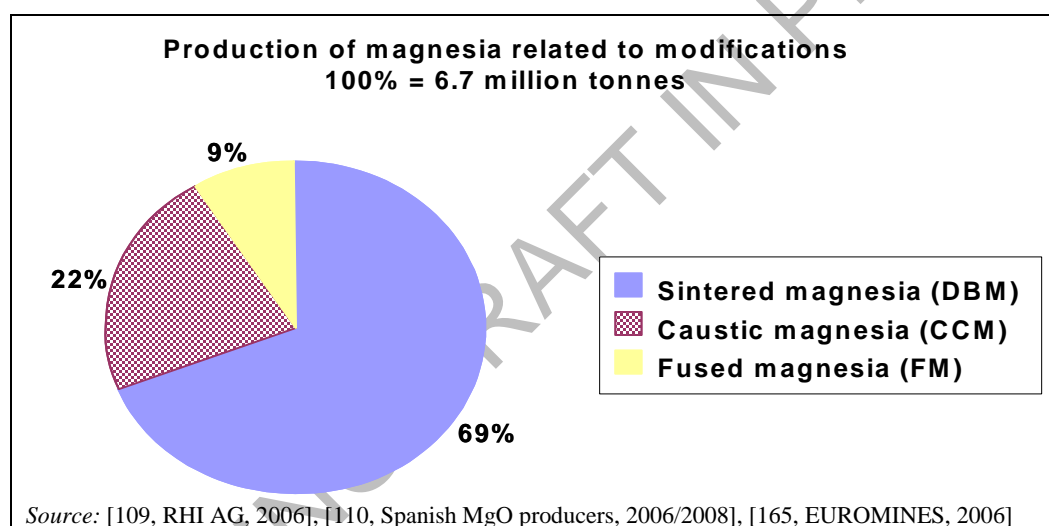
The estimated production of sintered magnesium oxide/magnesia in 2003 is shown in Table 3.2.

Type of magnesium oxide produced	Estimated magnesium oxide production (million t)
Natural magnesium oxide	5.8 <sup>(1)</sup>
Synthetic magnesium oxide	0.6 <sup>(2)</sup>
Total magnesium oxide production	6.4 <sup>(3)</sup>

<sup>(1)</sup> Magnesium oxide production by using the dry process route  
<sup>(2)</sup> Wet process route  
<sup>(3)</sup>  $\Sigma$  total production dry and wet process route  
Source: [109, RHI AG, 2006], [110, Spanish MgO producers, 2006/2008], [165, EUROMINES, 2006]

**Table 3.2: Worldwide production of sintered magnesium oxide/magnesia in 2003**

The worldwide production of different magnesium oxide (magnesia) modifications, such as sintered or dead burned (DBM), caustic calcined (CCM) and fused magnesia (FM) varied between 6.4 and 6.7 million tonnes in 2003 due to statistical inaccuracies. Figure 3.3 gives the production distribution overview of the different modifications/types of magnesium oxide (magnesia) which was produced worldwide in 2003. The total production was 6.7 million tonnes.



**Figure 3.3: Worldwide production of magnesium oxide modifications in 2003**

There are not so many magnesium oxide producers in the EU-27 so there is a correspondingly low number of plants producing sintered magnesia and these are shown in Table 3.3. In the EU-27, there are only known to be nine producers using 14 plants. On average, the number of kilns per plant is one to three, except for one producer who operates with eight kilns in a single plant. The economic activities of the magnesium oxide industry are restricted to a small area.

Country	Number of producers	Number of plants
Greece	1	1
Spain	2	2
Austria	2	5
Poland	1	1 <sup>(1)</sup>
Slovakia	3	5
Total	9	14

<sup>(1)</sup> Assumption  
Source: [109, RHI AG, 2006], [110, Spanish MgO producers, 2006/2008], [165, EUROMINES, 2006], [168, TWG CLM, 2007]

**Table 3.3: Producers of sintered magnesia in the EU-27**

Table 3.4 shows the production of raw magnesite from mines and the production of magnesia by using the dry process route in the EU-25 in 2003. More than 98 % of the mined magnesite is used for the production of the different magnesia products DBM, CCM and FM.

Country	Magnesite <sup>(1)</sup> production in 2003 (t)	Magnesia production capacity in 2003 (t)		
		Dead burned magnesia (DBM)	Caustic calcined magnesia (CCM)	Fused magnesia (FM)
EU-25	2 398 574			
Greece	549 049	84 635	92 350	
Spain	468 900	60 000	150 000	
Austria	766 525			6 000
Poland	33 000			
Slovakia	900 000			

<sup>(1)</sup> Mined raw ore, the raw material for magnesium oxide production  
Source: [109, RHI AG, 2006], [110, Spanish MgO producers, 2006/2008], [165, EUROMINES, 2006], [168, TWG CLM, 2007]

**Table 3.4: Production of magnesite and magnesia by using the dry process route in the EU-25 in 2003**

Raw magnesite is traded only to a small extent. Special grades are used in the ceramics and the steel industry and as a magnesium source for the production of other magnesium compounds. In 2003, these markets represented about 2 % of the referred production of magnesite [109, RHI AG, 2006], [110, Spanish MgO producers, 2006/2008], [165, EUROMINES, 2006].

### 3.1.2.1 Types of magnesium oxide (magnesia) products

#### 3.1.2.1.1 Magnesias

Magnesias is chemically pure magnesium oxide (MgO), also known as 'periclase'. The melting point of magnesia is at around 2800 °C. This high melting point is the reason for the preferred use of magnesia as the raw material for refractory products which are used in high temperature processes for the steel, cement, lime, glass and non-ferrous metals industries.

Magnesias can be produced and modified as follows:

- sintered or dead burned magnesia (DBM)
- caustic calcined magnesia (causter, CCM)
- fused magnesia (FM).

The differences in these types of magnesia products are the physico-chemical characteristics. The different grades of magnesia produced are defined by chemical purity. Depending on the origin, magnesia generally contains magnesium oxide (MgO) in a range of 55 – 98 %. The most important impurities that occur are SiO<sub>2</sub>, Fe<sub>2</sub>O<sub>3</sub>, CaO and Al<sub>2</sub>O<sub>3</sub>. These impurities affect the quality of the magnesia product. In caustic calcined magnesia, considerable amounts of CO<sub>2</sub> remain in the product [67, Austria, 2006],[109, RHI AG, 2006],[110, Spanish MgO producers, 2006/2008], [165, EUROMINES, 2006].

### 3.1.2.1.1.1 Sintered/dead burned magnesia (DBM)

Sintered magnesia (MgO = dead burned magnesia: DBM) is produced through a sinter burning process at temperature ranges of 1600 – 2200 °C. Different types are defined by the content of lime in the raw material which is in the range of <2 – 35 % and the SiO<sub>2</sub> content, which in general is required to be low. Special uses also require very low contents of iron. The product is characterised by a cubic crystal structure with an apparent density as a rule in the range of 3.05 – 3.45 g/cm<sup>3</sup> and with crystal dimensions in a range of 30 – 200 µm. Sintered magnesia or dead burned magnesia is produced as grains or briquettes.

### 3.1.2.1.1.2 Caustic calcined magnesia (CCM)

Caustic calcined magnesia (MgO = caustic calcined magnesia: CCM) is partially de-acidified magnesite or calcinated Mg(OH)<sub>2</sub>, where the original crystal modification is retained, e.g. the crystal structure of the original substance is retained during calcination at the decomposition temperature of between 600 – 800 °C and the CO<sub>2</sub> retention points are free (gaps in the crystal structure system). As a result, CCM has a high specific surface, which is the reason for the highly reactive behaviour of causter in comparison to DBM or FM. CCM generally occurs in loose form as powder (fine, porous) or as pieces in very loose chunks. Calcination at temperatures as high as 1300 °C is used for the production of various grades of CCM.

### 3.1.2.1.1.3 Fused magnesia (FM)

Fused magnesia is produced by a fusing process in an electric arc kiln by temperatures of 2800 °C. The difference between sintered and fused magnesia is, on the one hand, in the apparent density (fused magnesia has a higher density of 3.43 – 3.54 g/cm<sup>3</sup> than sintered magnesia) and, on the other hand, on the crystal size which is in the range of 200 to 2000 µm. Fused magnesia is used as refractory material and for some special applications, such as for nuclear reactors. In Europe, fused magnesia is produced in very small quantities. Therefore, the production of fused magnesia is not described in detail in this document.

## 3.1.3 The use of magnesia

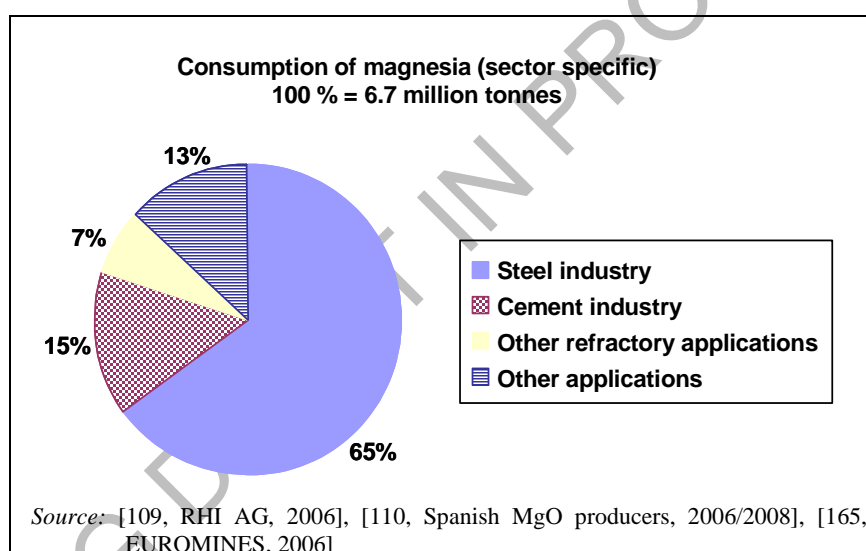
Sintered or dead burned magnesia is primarily used in the refractory industry. Example areas of application for refractory products using magnesia are:

- the steel industry, e.g. for electric arc furnaces, basic oxygen furnaces or other furnaces, steel converters, hot metal transport and machinery
- the cement industry, e.g. for the inlets of preheaters, cement kilns and coolers
- the non-ferrous metal industries, e.g. for furnaces
- the lime industry, e.g. for the inlets of lime kilns
- the glass industry, e.g. for melting furnaces, regenerator chambers.

For caustic calcined magnesia, the main applications can be found in:

- the agricultural industry as feed or fertiliser
- the steel production industry as slag conditioner
- the construction industry as floor covering and for insulation
- the manufacture of cellulose, paper, chemicals, pharmaceuticals, flame-proofing and sweeping materials
- the environmental protection industry.

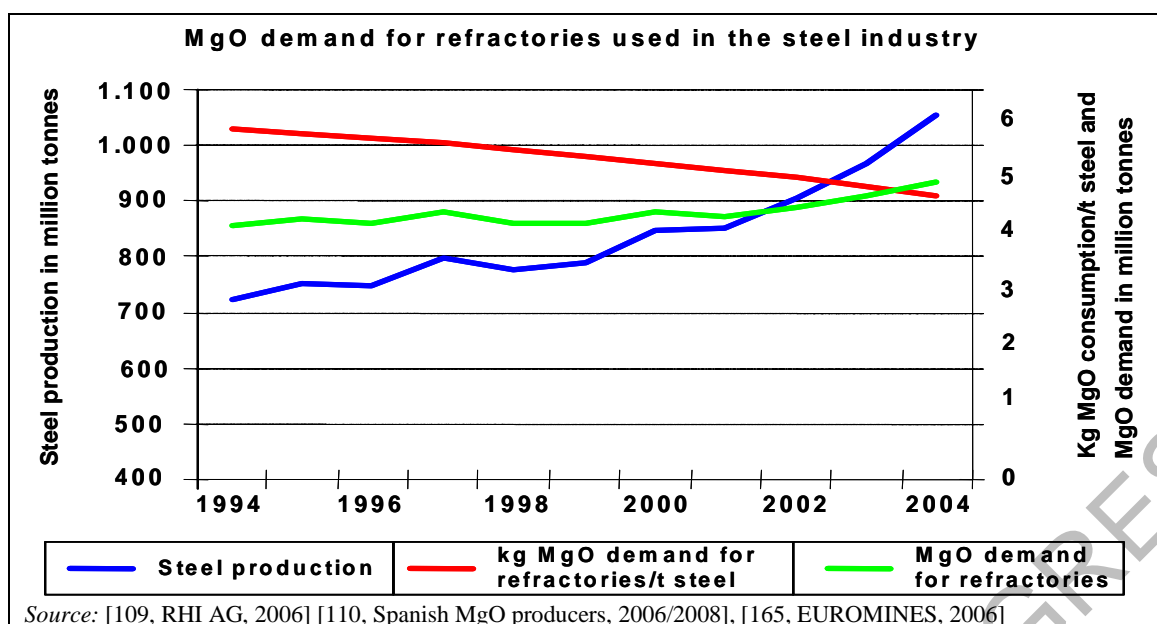
Based on a worldwide magnesia production of 6.7 million tonnes in 2003, Figure 3.4 shows the sector specific consumption of magnesia in different industries including the synthetic magnesia industry. Magnesia is mainly used for the production of refractory products. 65 % of magnesia used for refractories is produced in order to be used in the steel industry, 15 % in the cement industry, 7 % of magnesia production is used for other refractory applications, such as in the non-ferrous metals industries or in the glass industry and finally 13 % of total production is used for other applications. These other applications are very varied and a total of 80 applications are known – most of them are for CCM. The main applications can be found in agriculture as feed or fertiliser, in the construction industry as floor covering and for insulation, in the manufacture of cellulose, paper, chemicals, and pharmaceuticals, flame-proofing and sweeping materials as well as in environmental protection.



**Figure 3.4:** Sector specific consumption of magnesia worldwide in 2003

No statistics/assessments are available showing the distribution and the use of natural magnesia. However, it can be assumed that there are no significant differences to synthetic magnesia.

Worldwide, the specific use of refractory products containing magnesia is decreasing; however, worldwide steel production is increasing with the result that, from a global perspective, the demand for refractory products containing magnesia is still continuously increasing as shown in Figure 3.5. This figure also includes magnesia (MgO) used for slagging (10 % of the overall MgO consumption).



**Figure 3.5: Worldwide magnesia demand for the production of refractories used in the steel industry**

In 1994, worldwide production of raw steel was around 700 million tonnes while in 2005, steel production capacity achieved more than 1000 million tonnes. In the same period, the specific magnesia demand continuously decreased (-24 % between 1994 and 2004) from around 5 to 4.2 kg/t steel. However, globally seen and in combination with the increased steel production worldwide, the requirements for magnesia and also magnesite are increasing continuously. Parallel to an increased use of magnesia in the steel industry, the production of magnesite has also increased from 9.4 (1994) up to 12.5 (2003) million tonnes per year, as also shown in Figure 3.2 [67, Austria, 2006], [109, RHI AG, 2006], [110, Spanish MgO producers, 2006/2008], [165, EUROMINES, 2006], [168, TWG CLM, 2007].



## 3.2 Applied processes and techniques

### 3.2.1 Raw materials and preparation

For the production of magnesia products (DBM, CCM, FM), the most important raw materials are:

- magnesite (magnesium carbonate) =  $\text{MgCO}_3$  (dry process)
- brucite (magnesium hydroxide) =  $\text{Mg}(\text{OH})_2$  (dry process)
- bischofite (magnesium chloride) =  $\text{MgCl}_2 \cdot 6 \text{H}_2\text{O}$  (wet process)
- seawater and dolomite (wet process).

This document only covers the dry process route for the production of dead burned magnesia from magnesite, since the use of magnesium hydroxide (brucite) only plays a minor role. The production process based on magnesium chloride, the wet process route, will not be covered within this document. More information regarding the wet process route can be found in the Reference Document on Best Available Technique for the Manufacture of Large Volume Inorganic Chemicals – Solids and Others Industry (LVIC – S) where this process for the production of magnesium oxide is described [108, European Commission, 2006].

The raw materials are mined from open pit and underground mines and the first size reduction and preliminary treatment is achieved during the mining operation. Standard processing units are used for the preparation of raw materials such as crushing, grinding or milling and sieving plants. Depending on the nature of the rock, e.g. hardness, sizes, various types of primary and secondary crushers are used. However, the size of the stones should not be too small and only a small amount of fines should be the result.

For preparing magnesite, heavy sludge preparation is sometimes used. Raw materials are sometimes washed in order to exclude impurities. Furthermore, permanent magnet separators are used for magnetic preparation tasks.

Sintered or dead burned magnesia is usually ground, milled and, to some extent, handled magnetically following the firing process. Caustic calcined magnesia is often milled following the firing process and is then a finished product. Different types of machinery can be used in the milling process, e.g. ball mills, roll mills, swing mills and high pressure grinding rolls. Briquette presses are usually used for the production of causter briquettes (two-phase heat treatment).

The mining process is also not covered in this document. Useful information regarding mining/quarrying can be found in the Reference Document on Best Available Techniques for Management of Tailings and Waste-Rock in Mining Activities [47, European Commission, 2004].

#### 3.2.1.1 Magnesite

The term 'magnesite' denotes natural magnesium carbonate ( $\text{MgCO}_3$ ). Magnesite is partially derived from rock formation materials and it mostly occurs together with dolomite and forms deposits, which are generally very old (>400 million years old). In Europe, magnesite can be found in many places; however, few deposits of commercial value and producers exist. One of the largest deposits known is in the greywacke zone ('Grauwacken zone') in the 'Alps' mountains. Generally, two types can be distinguished, differing mainly in their iron content as follows:

- spar magnesite (type Veitsch, iron rich with 4 – 6 %)
- gel magnesite (type Kraubath, with a low iron content of <0.5 %).

Spar magnesite is characterised by crystal or surface crystal formations (macrocrystalline type) and typically the content of iron is high. Usually, the content of  $\text{Fe}_2\text{O}_3$  ranges between 5 and 8 %. The formation is usually metasomatic, i.e. one mineral was replaced by another without melting and the chemical composition was changed by fluid interactions. Significant deposits are found in Austria, Slovakia, North Korea, Brazil, the Asian parts of the CIS countries and China, where, to some extent, the raw material also contains a low amount of  $\text{Fe}_2\text{O}_3$ .

Gel magnesite does not have a macroscopic structure (microcrystalline or cryptocrystalline type). Its formation is a result of changes that have occurred in magnesium rich rocks (largely serpentine). The iron content is very low at less than 1 %. Significant deposits are found in Turkey, Greece and Australia.

### 3.2.2 Fuels

In 2007, the following different types of fuels were mainly used in the firing process:

- natural gas
- petroleum coke (petcoke)
- heavy fuel oil.

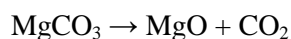
However, depending on the availability and economics, other fuels are also used, such as anthracite or coal. There is a good relationship between the efficiency and the price of petroleum coke (see also Section 3.4.5 and Figure 3.13). However, because of the high thermal energy demand and the high temperatures required for the production process, it is necessary in some cases to add other combustibles.

Air is usually added to the combustion process. When high temperatures are required for the sinter or dead burn process, the combustion air could be enriched with technically pure oxygen.

In 2007, waste material was not used as fuel due to the impurities that would then have been found either in the product or in the exhaust gases. Most of the products have to be pure and clean, without any impurities. The use of waste may have an effect on the product quality that has to be avoided because the refractory characteristics of the sintered or dead burned magnesia to be used for refractory bricks would be reduced. However, for the future and due to new techniques for co-incinerating waste materials and due to certain magnesia products, the magnesium oxide industry considers the use of different types of waste, e.g. plastics or wood. In this context, general and quality control aspects for the use of waste in both the cement and lime sectors can be found in Sections 1.2.4 and 2.2.5 of this document respectively.

### 3.2.3 General description of the production process of magnesia from magnesite (naturally sintered/dead burned magnesia)

Magnesia is produced by firing the treated and prepared natural stone raw material in a multiple hearth furnace (MHF), a shaft kiln or a rotary sintering kiln. The chemical reaction can be expressed as follows:



The chemical reaction is endothermic, depends on a high firing temperature and is very energy intensive. The input of energy is high ( $\Delta H = + 113 \text{ kJ/mol MgO}$ ). The process starts at a temperature of around 550 – 800 °C where the magnesite is de-acidified and carbon dioxide is released. The result from this reaction is the product caustic calcined magnesia (CCM), so-called 'causter'. In the next process step, CCM is further heat treated (fired) at temperatures of between 1600 to 2200 °C in one or two phases to sintered or dead burned magnesia. The temperatures, along with the duration of the treatment, are the decisive controlling factors in

obtaining a product which is well crystallised and which can achieve a high density. In this process, the crystal system of the magnesite (trigonal) changes to a cubic structure and a high increase in density is achieved.

The process scheme of the natural pathway for the production of the different types of magnesia is shown in Figure 3.6.

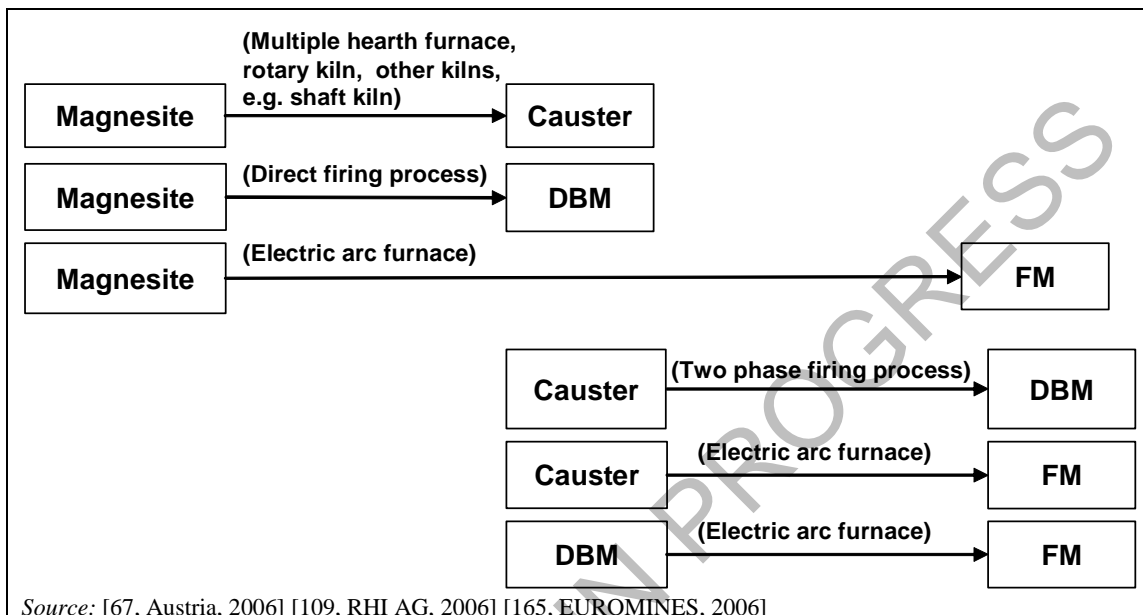


Figure 3.6: Process scheme of the natural pathway for magnesia production

### 3.2.3.1 Firing processes

#### 3.2.3.1.1 Direct firing process (single phase firing)

Raw magnesite is burned to sintered or dead burned magnesia in only one cycle by using shaft or rotary sintering kilns. The advantage of this process is that the energy requirement is lower compared to the two phase heating process. However, the qualities of the sinter product depend on the raw material and cannot be changed by adding different materials such as, e.g. zirconium dioxide or chrome oxide.

The first process is generally performed with the raw material being analysed in batches and then separated and stored in quality classes. A cycle of charges is made by mixing different quality classes from raw materials. This raw material mix is then fired in a shaft or rotary sintering kiln by temperatures of between 1450 and 2200 °C. The product is so-called 'raw sinter'. After this firing process, this raw sinter magnesia can be further processed and treated.

##### 3.2.3.1.1.1 Preparation of the 'raw sinter'

In most cases, preparation and treatment of 'raw sinter' is necessary. Iron rich magnesia is prepared and treated in two stages:

- crushing and milling (density, chromatic, flotation; treatment before the kiln burning process)
- magnetic preparation (treatment after the kiln burning process).

Finally, the cooled raw sinter can be treated magnetically at an ambient temperature. The separating characteristic is the lime content of the sinter material. A low lime content of the

sinter material is a requirement for the production of moulded refractory products (bricks). Magnetic separation is carried out by using either a permanent magnet separator or an electromagnetic separator. Magnesia ferrite ( $\text{MgFe}_2\text{O}_4$ ) is a mineral phase that is used as the magnetising carrier which is formed when the magnesia cools down from temperatures of 1200 to 900 °C.

The decisive principle in this process is: the faster the cooling process, the more the magnesia ferrite is formed. Thus this results in an improved magnetic preparation process, i.e. the more magnesia ferrite that is available the better and the magnetic preparation process is improved.

A physical characteristic is used that in CaO poor material, more magnesia ferrite is formed than in CaO rich material. The separation is made through the relative proportion of magnesia ferrite. Thus, the CaO poor particles are more strongly magnetisable and have a better stickability to the magnetic drum than the CaO rich particles.

The result of this magnetic sinter preparation is:

- CaO poor sintered magnesia (magnesia ferrite rich with good magnetising properties) and
- CaO rich sintered magnesia (higher CaO content with poor magnetising properties).

The output varies significantly in dependence on the raw sinter charge and the position of the separator on the drum discharge.

Figure 3.7 shows an example process diagram of magnesia production using the dry process route.

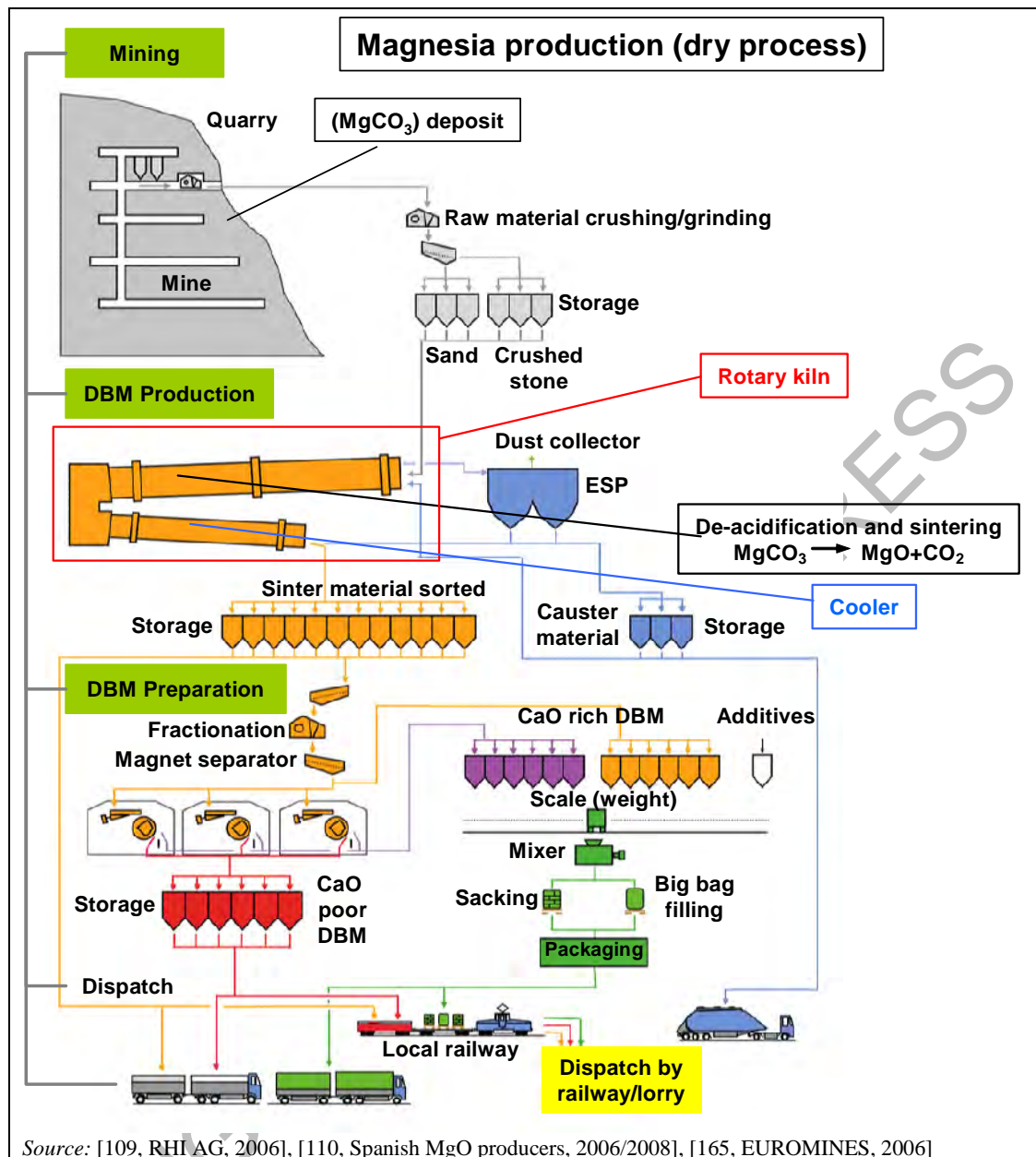


Figure 3.7: Example process diagram of magnesia production using the dry process route from a DBM plant

### 3.2.3.1.2 Two phase firing process

Various units and kiln types can be used in the first step of this process such as overlying bed type kilns, shaft or rotary sintering kilns, multiple hearth furnaces (MHF) and especially constructed kiln types to produce the caustic calcined magnesia (CCM).

First of all, the raw magnesite is de-acidified in a kiln by temperatures of up to 1000 °C. The caustic calcined material (CCM) can then be ground. Grinding is very important for the achievement of a high density DBM. This ground material is formed into briquettes which are then burned in a rotary or a shaft kiln to sintered/dead burned magnesia (DBM).

In contrast to the single phase firing process, the characteristics of the sintered material can be influenced significantly in crystal size and unprocessed density by the addition of various materials, the so-called 'doping agents' such as, e.g. chromium oxide, zirconium oxide.

### 3.2.3.2 Types of kilns – techniques and design

Various types of mineral deposits demand, to some extent, very varied production methods. It has to be noted that no standard kiln unit exists for the production of magnesia from magnesite (natural process). Furthermore, standardisation in the processes and techniques used do not exist as well. However, a wide range of processes, techniques and kilns are used for the production of magnesia.

The type of kiln to be used is determined by different parameters, such as:

- characteristics of magnesite which is available at the site
- type of product which is produced (sintered magnesia, fused magnesia, caustic magnesia)
- quality and characteristics of the product, e.g. density, purity, crystal size
- price and/or availability of the fuels used.

The kiln type is very often specific to the raw material itself and production capacities, and the quality of the product depends very much on the kiln type and the type of process. Different types of kilns can be used, but rotary or shaft kilns are the most commonly used kilns. For the single phased heat processing of sintered magnesia, shaft or rotary sintering kilns (long rotary kilns, Lepol kilns) are used. By using a two phase process for producing sintered magnesia, for the first phase, the same types of kilns are used as for pure caustic production, such as shaft or rotary sintering kilns. Furthermore, for the subsequent sintering process, shaft or rotary kilns are used. Rotary kilns, overlying bed type kilns and especially constructed kiln types are used for the production of caustic calcined magnesia. Electric arc furnaces are used for the production of fused magnesia. These kiln facilities (except electric arc kilns and especially constructed kiln types) use the counter flow principle in order to achieve high energy efficiencies.

In shaft kilns usually coarse broken magnesite with grain sizes of more than 50 mm or CCM briquettes can be used. Fine grain magnesite is either fired in rotary kilns or is caustered, made into briquettes and fired in shaft kilns or in rotary kiln or is dumped, as shown in Figure 3.8.

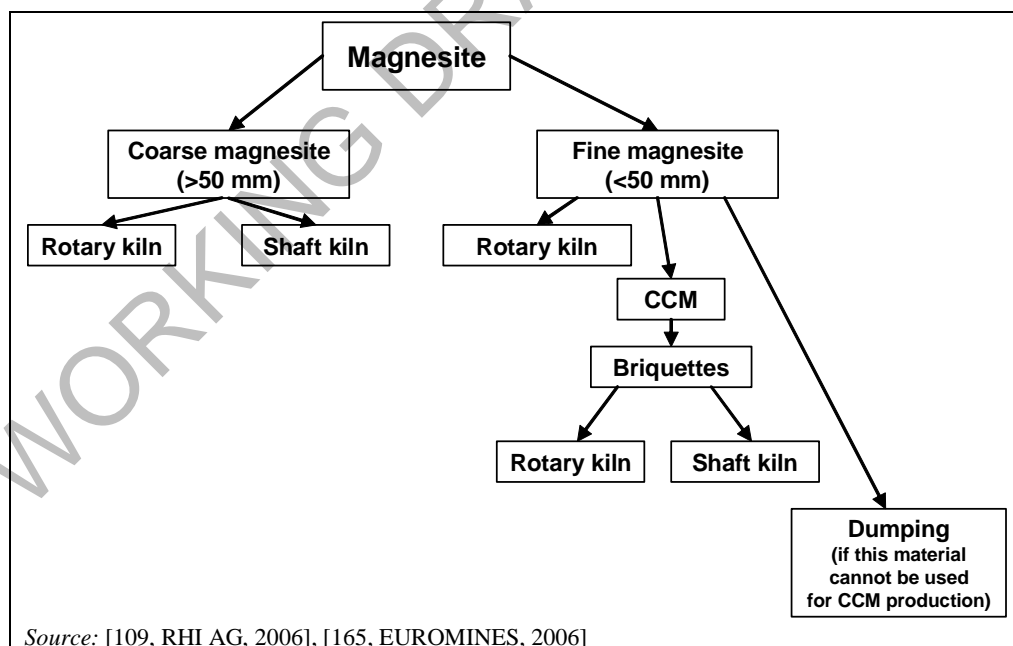


Figure 3.8: Pathway of coarse and fine magnesite for magnesia production

### 3.2.3.2.1 Rotary kilns

#### 3.2.3.2.1.1 Rotary kilns with a preheater

In rotary kilns with a preheater (Lepol kiln), raw materials are fed into the feeding and preheating zone of the kiln via a preheating grid. First of all, raw materials are preheated and partially de-acidified by hot exhaust gases by the counter flow principle. The partially de-acidified magnesite is moved into the kiln where de-acidification is completed before the burning zone of the kiln. During the preheating phase, parts of the raw materials in the form of fine-grained MgO causter fall through the Lepol grid and are then directly fed into the burning zone of the kiln. In the burning zone, the materials are sintered by temperatures of between 1600 and 2200 °C. The kiln cycle time is between 8 and 16 hours. For further processing, the sintered material is cooled down to 200 °C in the cooling zone of the kiln. The operating principle of a rotary kiln with a preheater used for the dry process of magnesia production is shown in Figure 3.9. Rotary kilns with a preheater used for the production of sintered/dead burned magnesia (DBM) have a length of between 60 and 80 m and a diameter of between 2 and 4 m [67, Austria, 2006], [110, Spanish MgO producers, 2006/2008], [109, RHI AG, 2006], [165, EUROMINES, 2006].

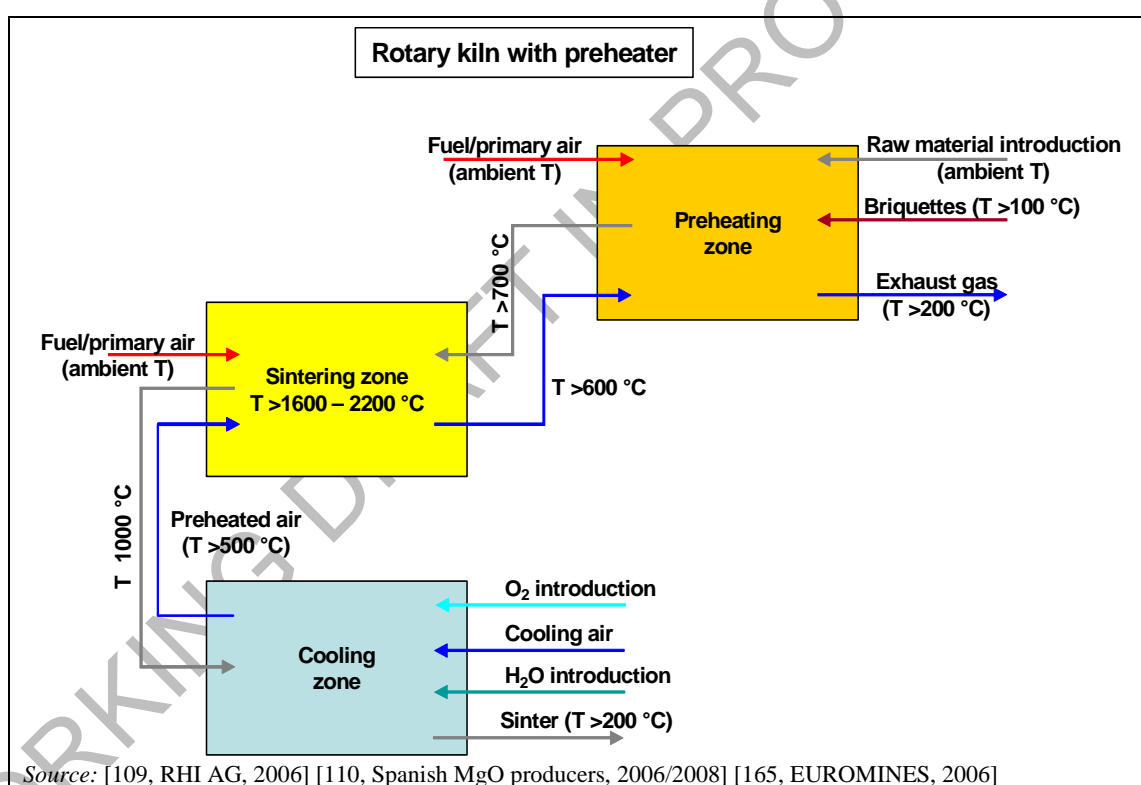


Figure 3.9: Operating principle of rotary kilns with a preheater in magnesia production

#### 3.2.3.2.1.2 Long rotary kilns

In long rotary kilns, preheating, de-acidification and sintering take place entirely inside the kiln. This is very largely the reason why this kiln type is significantly longer than rotary kilns with a preheater. Long rotary kilns used for DBM production have a length of between 80 and 120 m and a diameter of between 2 and 4 m.

As a result of the rotation and the horizontal declivity of the kiln, the materials in the kiln are transferred to the sintering zone and are preheated and de-acidified, as a result of the exhaust gas temperature profile before reaching the sintering zone. The sintering process takes place in the sintering zone of the long rotary kiln at temperatures of between 1600 and 2200 °C where

the magnesia sinter material obtains the required density. At the kiln discharge, the product is transported into the cooling tube. Cooling takes place by using a secondary air current that is sucked in by the counter flow principle. This preheated air from the cooler is then used again as combustion air. Figure 3.10 shows the operating principle of a long rotary sintering kiln used for the dry process of magnesia production.

The cooled sintered product is transported by transport conveyor to further processing.

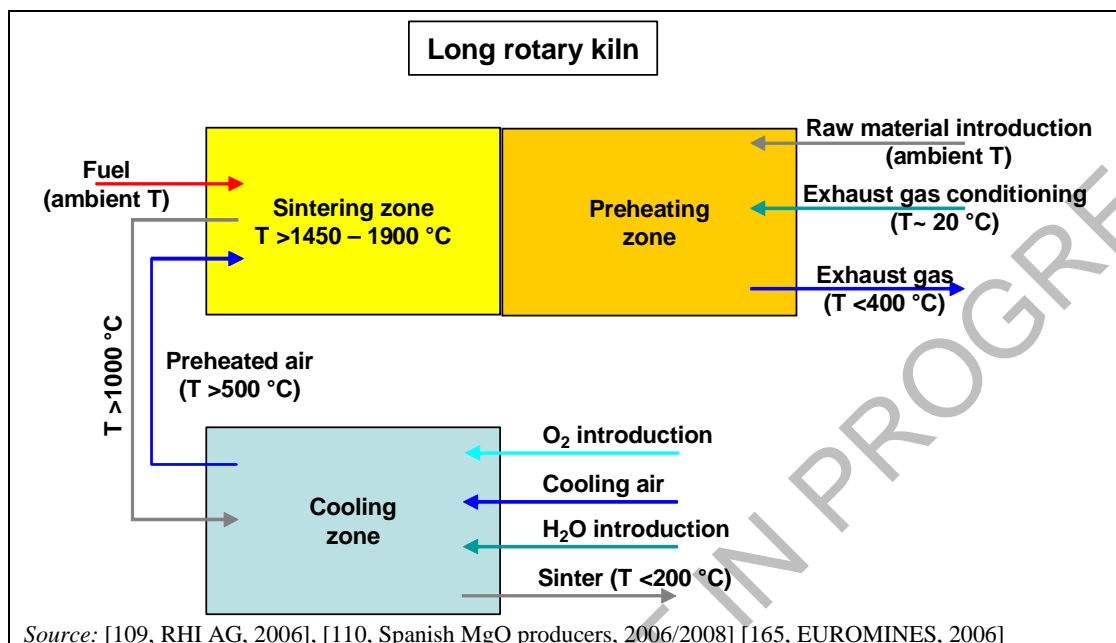


Figure 3.10: Operating principle of long rotary kilns in magnesia production

### 3.2.3.2.2 Shaft kilns

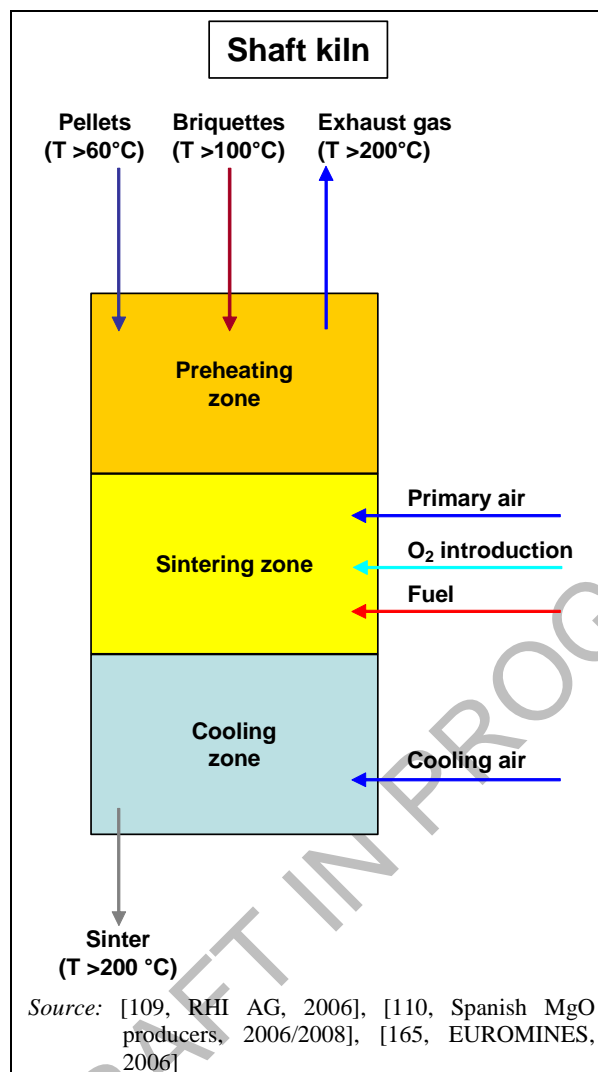
Different types of shaft kilns can be used for magnesia production.

#### 3.2.3.2.2.1 Shaft kilns with a rotating plate

Fine ground refractory raw material which is prepared in defined mixtures, is placed in a rotating pelleting drum formed into pellets ( $\varnothing$  20 – 30 mm) by adding water. The pellets are dried in a continuous flow process before they are fired in a shaft kiln to temperatures of approximately 1750 °C. The sinter product is discharged via a rotating plate and stored in an intermediate storage prior to further processing. The operating principle of a shaft kiln used in magnesia production is shown in Figure 3.11.

Also natural magnesite rock with a size of between 20 – 200 mm can be burned by using this process.





**Figure 3.11: Operating principle of shaft kilns in magnesia production**

#### 3.2.3.2.2.2 Shaft kilns with a rotating grate

By using this type of shaft kiln, a special type of briquettes is produced. The briquettes have a composition of caustered magnesite and chrome ore and are pressed in a roller bricking process by adding water as a binder. In order to achieve the required sinter quality in this type of kiln, temperatures of 2200 °C are used. Furthermore, an oxygen enriched combustion air blast is required for this purpose. In the kiln, the compact material column is transported by a rotating discharge and is then discharged from the kiln.

This sinter product is finely ground and sieved before it is further processed into refractory products.

#### 3.2.3.2.2.3 Double shaft kiln

By using this kiln type, raw magnesite is placed into one shaft at the top of the kiln, the so-called 'preheating shaft' where raw magnesite is preheated and de-acidified. Following the preheating zone, the shaft is divided into two sections – called the double shaft – where sintering and the cooling processes take place. After passing the preheating zone, the raw magnesite is sintered by temperatures of 1600 – 2200 °C. In the cooling zones at the bottom of the double shaft kiln, the sintered magnesia product is cooled down to temperatures of less than 200 °C by using cooling air. The cooled sintered magnesia product is then discharged from the

kiln. Figure 3.12 shows the operating principle of a double shaft kiln used in magnesia production.

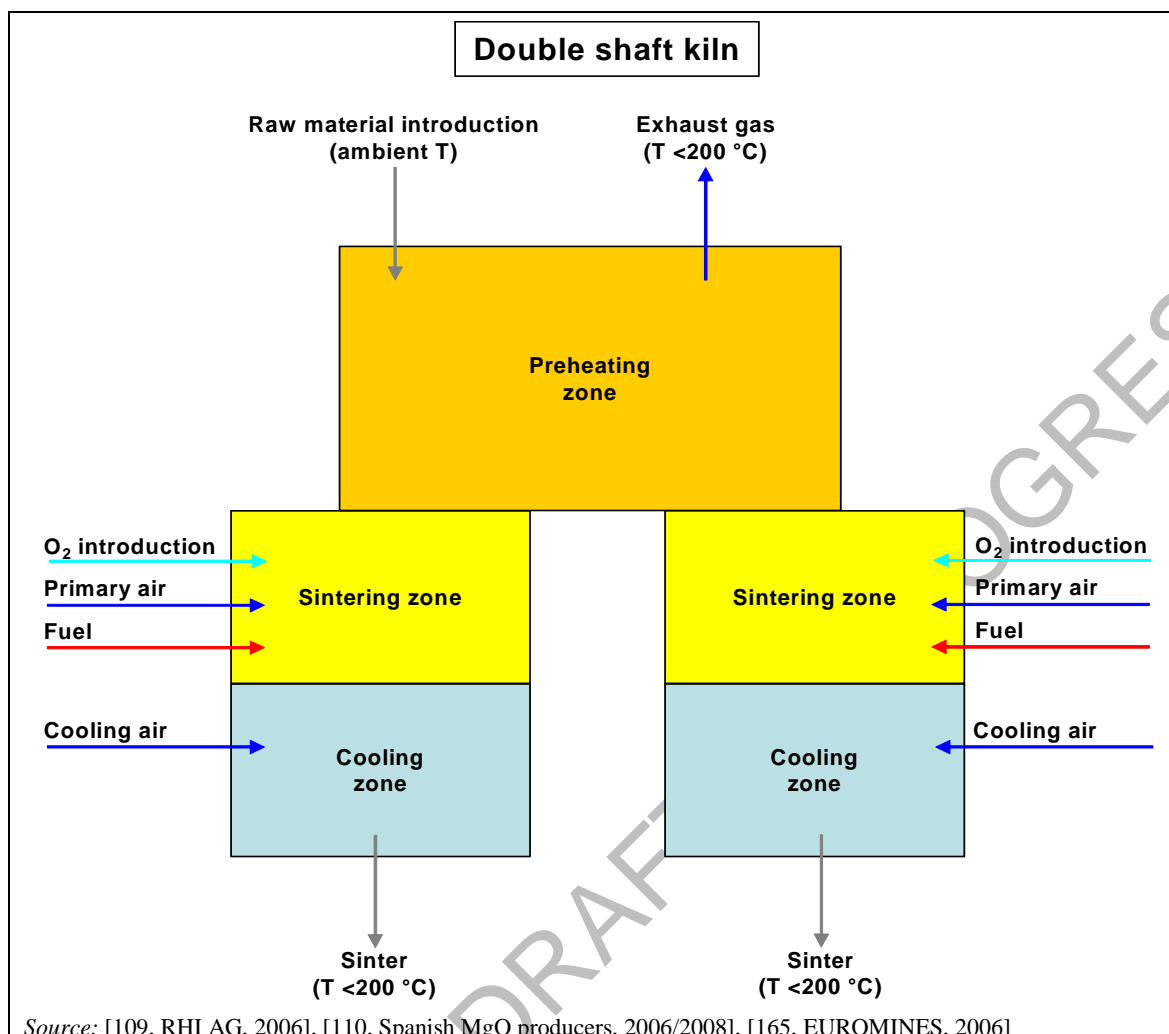


Figure 3.12: Operating principle of double shaft kilns used in magnesia production

### 3.2.4 Production of fused magnesia

Fused magnesia is produced in special electric arc kilns which operate in batch processes. In principle, the kiln consists of a platform car where the kiln outlet (frustum) is placed.

The raw material is fused inside this kiln outlet by an electric arc which is fired between two graphite electrodes. The fusing process is vertical from the bottom to the top. During the fusing process, the raw material is fed in batches into the kiln from the top. No casting is done. The fused material remains on the platform car within the frustum where the cooling process takes place as well. After fusing, the car is moved from the electrodes and the next cycle can start. Some 5 to 8 tonnes of fused magnesia are generally obtained per product block. Raw stone, caustic calcined or sintered/dead burned magnesia can be mixed and used as the raw process material. It has to be noted that during the cooling process impurities form at the edges (in the crust) and the chemically purest parts are available in the centre of the fused product block.

After cooling, the product block is toppled, reduced in size by grinding and is often sorted manually. The main production country is China. However, a few production locations can also be found within the European Union where the quantities produced are very low. Because of

this, details regarding the production of fused magnesia is not covered in this document [109, RHI AG, 2006], [110, Spanish MgO producers, 2006/2008], [165, EUROMINES, 2006].

WORKING DRAFT IN PROGRESS

### 3.3 Current consumption and emission levels

The main environmental issues for the production of different types of magnesia are the use of energy and emissions to air. The burning process of magnesia is the principal user of energy and the main source of emissions. The secondary grinding process as well as subsidiary operations (such as crushing, screening, conveying, storage and discharge) can also be significant.

It has to be noted that, if not otherwise mentioned in this document, for this section concerning the magnesium oxide industry, the standard conditions for measurements of volume flows and concentrations are related to the following definitions which are also stated in the Glossary:

m <sup>3</sup> /h	volume flow: if not otherwise mentioned in this document, the volume flows refer to 10 vol-% oxygen and standard state
mg/m <sup>3</sup>	concentration: if not otherwise mentioned in this document, the concentrations of gaseous substances or mixtures of substances refer to dry flue-gas at 10 vol-% oxygen and standard state
standard state	refers to a temperature of 273 K, a pressure of 1013 hPa and dry gas

In addition, it has to be noted that the emissions ranges refer to a reference oxygen level of 10 % although the actual oxygen level within the firing process is much lower than 10 %. The calculation formula for calculating the emissions concentration is shown below:

$$E_R = \frac{21 - O_R}{21 - O_M} * E_M$$

$E_R$  (mg/Nm<sup>3</sup>): emissions concentration related to the reference oxygen level  $O_R$   
 $O_R$  (vol %): reference oxygen level  
 $E_M$  (mg/Nm<sup>3</sup>): emissions concentration related to the measured oxygen level  $O_M$   
 $O_M$  (vol %): measured oxygen level

Additional useful information on monitoring can be found in the Reference Document on the General Principles of Monitoring (MON) [151, European Commission, 2003].

#### 3.3.1 Consumption of raw materials (unprocessed magnesite) and water

At high temperatures, magnesite (MgCO<sub>3</sub>) is thermally decomposed to magnesia (MgO) and carbon dioxide (CO<sub>2</sub>). Taking as a basis the molecular weight of magnesite (84.31 g/mol), the following quantities of magnesia and carbon dioxide result from the decomposition as shown in Table 3.5:

Material	Amount of			Total amount (g/mol)
	Mg (g/mol)	C (g/mol)	O (g/mol)	
Magnesite (MgCO <sub>3</sub> )	24.31	12.01	48.00	84.31
Carbon dioxide (CO <sub>2</sub> )	-	12.01	32.00	44.01
Magnesia (MgO)	24.31	-	16.00	40.30

Source: [109, RHI AG, 2006], [110, Spanish MgO producers, 2006/2008], [165, EUROMINES, 2006]

Table 3.5: Amounts of magnesia and carbon dioxide after decomposition

This result can also be presented in relative terms as a material share/composition from magnesite as shown in Table 3.6.

Material	Share in magnesite (MgCO <sub>3</sub> ) (%)
Magnesia (MgO)	47.80
Carbon dioxide (CO <sub>2</sub> )	52.20
Total	100.00
<i>Source:</i> [109, RHI AG, 2006], [110, Spanish MgO producers, 2006/2008], [165, EUROMINES, 2006]	

**Table 3.6:** Yield of magnesia and carbon oxide in magnesite

During the decomposition of 1 kg magnesite, approximately 522 g of carbon dioxide and 478 g of magnesia are produced in this process. This means that for the production of one tonne of magnesia (MgO), 1.092 tonnes carbon dioxide result from the carbonate decomposition. However, this issue is theoretical because magnesite has different impurities, such as SiO<sub>2</sub>, CaO, Fe<sub>2</sub>O<sub>3</sub>. It has to be noted that, as a general rule, for the production of one tonne of magnesia an amount of between 2.1 to 2.4 tonnes of magnesite is required according to the magnesite ore, quality produced and the type of kiln used [109, RHI AG, 2006] [110, Spanish MgO producers, 2006/2008], [165, EUROMINES, 2006], [168, TWG CLM, 2007].

#### *Water consumption*

The use of process water is low since only a small quantity of water is used, e.g. for washing the raw material (magnesite) in order to exclude impurities or to cool the magnesia product in the cooling zone of the kiln and for the heavy media separation process. There are some operations with exhaust gas washing systems, however, and the emissions gases are washed with water. Water is required in a quantity of around 5 – 12 m<sup>3</sup>/t magnesia product [109, RHI AG, 2006], [110, Spanish MgO producers, 2006/2008], [165, EUROMINES, 2006], [168, TWG CLM, 2007].

### 3.3.2 Energy consumption

The manufacture of magnesia (dry process) is energy intensive as magnesia, mainly DBM, is manufactured by very high temperatures.

Magnesite (MgCO<sub>3</sub>) is thermally decomposed to magnesia (MgO) and carbon dioxide (CO<sub>2</sub>). The process is highly endothermic and its theoretical reaction enthalpy is 2803 MJ/kg MgO. The decomposition of magnesite begins at a temperature of 550 °C and is completed at a temperature of below 800 °C if it contains significant amounts of other carbonates.

Natural gas, petroleum coke and fuel oil are used for the firing process. Table 3.7 shows the fuel requirement for the production of one tonne of sintered magnesia by using a direct heat process. The higher values mentioned in this table are required for sintered or dead burned magnesia production.

Fuels	Minimum	Maximum
Natural gas	176 Nm <sup>3</sup> /t	310 Nm <sup>3</sup> /t
Petroleum coke	240 kg/t	393 kg/t
Fuel oil	190 kg/t	330 kg/t
<i>Source:</i> [109, RHI AG, 2006], [110, Spanish MgO producers, 2006/2008] [165, EUROMINES, 2006]		

**Table 3.7:** Fuel requirements for the production of one tonne magnesia (MgO)

The energy demand for magnesia production ranges between 6 and 12 GJ/t MgO and is determined by different factors, such as the characteristics and moisture content (wet or very dry) of raw magnesite.

In order to achieve the very high combustion temperature of above 2000 °C that is required, oxygen can also be used. The amount of oxygen required is between 15 and 150 Nm<sup>3</sup>/t sintered magnesia. It has to be noted that, if special types of sintered magnesia with very high levels of purities or large crystal dimensions are to be produced, the values can be significantly higher - up to 150 Nm<sup>3</sup>/t.

Electrical energy is used for mechanical machinery, e.g. for the ventilation system, the briquette process and for pumps. Electricity is usually purchased from electricity providers (national grid). The electricity requirement can vary depending on the machinery in use and is typically in the range of between 75 and 180 kWh/t (270 – 648 MJ/t) sintered magnesia. The values are similar for the production of caustic magnesia.

Significantly more electrical energy (electric arc furnaces) in a range of 3500 – 4500 kWh/t is required for the production of fused magnesia. However, for the production of very pure grade magnesia the value for the energy requirement can be doubled or can even be above that [109, RHI AG, 2006], [165, EUROMINES, 2006].

### 3.3.3 Emissions

Emissions to air, water and land (process losses/waste) and also noise emissions arise during the manufacture of magnesium oxide/magnesia using the dry process route. In this section, ranges of air pollutant emissions are presented for the dry process of magnesium oxide/magnesia manufacture.

#### 3.3.3.1 Emissions to air

Significant emissions to air arise from the firing process, such as dust, NO<sub>x</sub>, SO<sub>x</sub> and CO. These emissions partially derive from the magnesite used as raw material and partially from the fuels used.

Due to the high firing temperatures in the kiln, SO<sub>2</sub> from fuels will normally not be covered in the product. However, when lower firing temperatures are used for kiln firing, SO<sub>2</sub> is only partially absorbed by the product and covered within the dust arising from the firing process (see Section 3.4.7.3). SO<sub>2</sub> emissions originating from the raw material (magnesite) depend on the content of sulphur in the raw material. They are, in principle, low because of the low content of SO<sub>2</sub> in most of the raw materials. However, in some cases, the SO<sub>2</sub> emissions from raw materials can be 50 % of the total SO<sub>2</sub> emissions. Furthermore, the sulphur content in the raw material is related to the particle or grain size of the raw material. In Table 3.8, examples are given for the relationship between the grain size and the sulphur content in the raw materials.

Grain size of the raw materials (mm)	Sulphur content in the raw materials (%)
>1	0.04
0.02 – 1	0.19
<0.02	1.80
<i>Source:</i> [110, Spanish MgO producers, 2006/2008], [168, TWG CLM, 2007]	

**Table 3.8:** Examples of the relationship between grain size and sulphur content in the raw materials

The comparison of different energy sources based on specific costs in EUR/GJ and the sulphur content from these fuels is shown in Figure 3.13. Petcoke contains the highest amount of sulphur followed by hard coal and anthracite.

The so-called 'CO<sub>2</sub> process emissions' result from the decomposition of magnesite (MgCO<sub>3</sub>) to magnesia (MgO) and around 1 t CO<sub>2</sub>/t magnesia may occur. Furthermore, CO<sub>2</sub> emissions also result from the fuel combustion process, e.g. by using natural gas or petcoke. Around 0.4 to 1.3 t CO<sub>2</sub>/t sintered magnesia are contributed from the fuel combustion process to the CO<sub>2</sub> emissions.

Emissions to air do not only occur during the firing process, but also during other manufacturing steps, such as:

- storage and handling of raw materials, fuels or products – dust emissions can arise
- grinding and milling processes – dust emissions can arise.

Diffuse dust emissions mainly arise from the storage and handling of raw materials and fuels and from vehicles used at the plant. Dust emissions from the packaging and dispatch of the magnesia product can also be significant. Simple and linear site layouts as well as organisational techniques are advisable to minimise possible sources of diffuse dust [67, Austria, 2006], [109, RHI AG, 2006], [110, Spanish MgO producers, 2006/2008] [165, EUROMINES, 2006].

Values of different air emissions resulting from the sintering process by typical exhaust gas volume flows of between 4000 and 12000 m<sup>3</sup>/t sintered magnesia are shown in Table 3.9. It has to be noted that not all emissions concentrations shown in Table 3.9 refer to standard conditions because for some data reference conditions were not provided.

Emissions component	Unit	Medium concentration <sup>(1)</sup>	Maximum concentrations <sup>(2)</sup>
Dust	mg/Nm <sup>3</sup>	20 – 118	400
NO <sub>x</sub>	mg/Nm <sup>3</sup>	650 – 2500 <sup>(3)</sup>	5000 <sup>(3)</sup>
SO <sub>2</sub>	mg/Nm <sup>3</sup>	10 <sup>(4)</sup> – 3350 <sup>(3)</sup>	5000 <sup>(3)</sup>
CO	mg/Nm <sup>3</sup>	33 – 1000	1323
CO <sub>2</sub>	g/Nm <sup>3</sup>	165 – 350	360

<sup>(1)</sup> Average concentrations achieved by a long observation period, measured once a year for one week  
<sup>(2)</sup> Short term peak values  
<sup>(3)</sup> Higher values are related to sulphur rich fuels and installations with the lowest/least installed abatement techniques  
<sup>(4)</sup> Use of natural gas  
<sup>(5)</sup> Higher values for high temperature DBM process  
 Source: [67, Austria, 2006], [109, RHI AG, 2006], [110, Spanish MgO producers, 2006/2008], [165, EUROMINES, 2006]

**Table 3.9: Concentrations of emissions components occurring from the magnesium oxide industry in the EU-27**

Depending on the type of fuel used in the process, up to 50 % of the sulphur dioxide may result from fuels (see also Section 3.4.5 and Figure 3.13 for the sulphur content in fuels). By producing caustic magnesia in a rotary kiln, about 40 – 50 % of the sulphur dioxide resulting from the fuel is recovered mainly from the filter dust. It has been reported that injection of reactive MgO grades into the flue-gas stream reduces the SO<sub>2</sub> emissions to below 1500 mg/Nm<sup>3</sup> for an initial SO<sub>2</sub> value of 3000 mg/Nm<sup>3</sup> [168, TWG CLM, 2007], [182, TWG CLM, 2008].

### 3.3.3.2 Process losses/waste

Process losses/waste originating from magnesia manufacture are different types of magnesium carbonate dusts which are separated in off-gas cleaning units, e.g. the dust precipitator. The dust types are, e.g. magnesium carbonate containing various proportions of caustic calcined and

sintered magnesia. Packaging waste (plastic, wood, metal, paper, etc.) arises from the packaging step.

Some of the dust types can be recycled and re-used within the process. Furthermore, collected dust can also be used within other environmental applications, e.g. industrial waste water treatment, metal capture in landfilling. The techniques used for the dusts and other wastes at waste disposal facilities range from re-use in marketable products and recycling through to disposal.

Washing fluids used for wet washing go through a phased sedimentation process to separate the solid materials. The solids that are obtained in this process are stored at an intermediate storage site for later use within the process while water is re-used and fed back into the system.

Sludge resulting from the wet process of the flue-gas desulphurisation (settling and/or filtration methods; one plant exists in Austria) can be re-used in the process or in other sectors.

### 3.3.3.3 Emissions to water

Water is used in different stages of the process. Water for washing the raw materials (magnesite) and for the heavy media separation process is re-used in the process after sludge decantation and clarification. Furthermore, water is used to cool the product in the cooling zone of the kiln. However, this water is evaporated because of the high process temperatures. Water is also used for some operations with exhaust gas washing systems where emissions gases are cleaned.

No waste water is produced by the magnesia production processes using the dry process route. Regarding the wet process of the flue-gas desulphurisation (one plant exists in Austria), waste water is produced. This waste water has to be treated with settling and/or filtration methods to separate the sulphite/sulphate sludge. This sludge can be re-used in the process or in other sectors.

### 3.3.3.4 Noise

The extraction and processing of raw material as well as magnesia production inevitably includes noisy operations. The operation of large and heavy machinery and large fans can give rise to noise and/or vibration emissions.

Natural noise barriers, such as office buildings, walls, trees or bushes may be used in order to reduce noise emissions. Plants are required to comply with reduction standards in compliance with national legislation.

### 3.3.4 Monitoring

To control kiln processes, continuous measurements are recommended for the following parameters:

- temperature
- pressure
- O<sub>2</sub> content
- CO content.



Additionally, continuously taking measurements may be appropriate for the following parameters:

- NO<sub>x</sub> content
- SO<sub>2</sub>
- dust.

For establishing and in order to accurately quantifying the emissions, periodic measurements of the following parameters are reported:

- NO<sub>x</sub> content
- dust
- SO<sub>2</sub>
- (CO<sub>2</sub> – is generally calculated).

Additional useful information regarding monitoring can be found in the Reference Document on the General Principles of Monitoring [151, European Commission, 2003].

WORKING DRAFT IN PROGRESS

### 3.4 Techniques to consider in the determination of BAT

**\*\*NOTE to Article 13 Forum members: Old introductory text have been deleted and replaced with the new standard text adapted to the specificities of the CLM BREF\*\***

This section describes techniques (or combinations thereof), and associated monitoring, considered to have the potential for achieving a high level of environmental protection in the activities within the scope of this document. The techniques described will include both the technology used and the way in which the installations are designed, built, maintained, operated and decommissioned.

It covers environmental management systems, process-integrated techniques and end-of-pipe measures. Waste prevention and management, including waste minimisation and recycling procedures are also considered, as well as techniques that reduce the consumption of raw materials, water and energy by optimising use and reuse.

Annex III to the Directive lists a number of criteria for determining BAT, and the information within this chapter will address these considerations. As far as possible, the standard structure in Table 1.30 is used to outline the information on each technique, to enable a comparison of techniques and the assessment against the definition of BAT in the Directive.

This section does not necessarily provide an exhaustive list of techniques which could be applied in the sector. Other techniques may exist, or may be developed, which could be considered in the determination of BAT for an individual installation.

Type of information considered	Type of information included
Description	A brief description of the technique using, as appropriate, chemical or other equations, pictures, diagrams and flow charts
Achieved environmental benefits	The <b>main</b> potential environmental benefits to be gained through implementing the technique (including reduced consumption of energy; reduced emissions to water, air and land; raw material savings; as well as production yield increases, reduced waste, etc.).
Cross-media effects	<p>Relevant negative effects on the environment due to implementing the technique, allowing a comparison between techniques in order to assess the impact on the environment as a whole. This may include issues such as:</p> <ul style="list-style-type: none"> <li>• consumption and nature of raw materials and water</li> <li>• energy consumption and contribution to climate change</li> <li>• stratospheric ozone depletion potential</li> <li>• photochemical ozone creation potential</li> <li>• acidification resulting from emissions to air</li> <li>• presence of particulate matter in ambient air (including microparticles and metals)</li> <li>• eutrophication of land and waters resulting from emissions to air or water</li> <li>• oxygen depletion potential in water</li> <li>• persistent/toxic/bioaccumulable components (including metals)</li> <li>• generation of residues/waste</li> <li>• limitation of the ability to reuse or recycle residues/waste</li> <li>• generation of noise and/or odour</li> <li>• increased risk of accidents.</li> </ul> <p>The Reference Document on Economics and Cross-media Effects (ECM) should be taken into account.</p>
Operational data	Actual and plant-specific performance data (including emission levels, consumption levels – of raw materials, water, energy – and amounts of residues/wastes generated).

Type of information considered	Type of information included
	<p>Any other useful information on the following items:</p> <ul style="list-style-type: none"> <li>• how to design, operate, maintain, control and decommission the technique</li> <li>• emission monitoring issues related to the use of the technique</li> <li>• sensitivity and durability of the technique</li> <li>• issues regarding accident prevention.</li> </ul>
Applicability	<p>It is indicated whether the technique can be applied throughout the sector. Otherwise, the main general technical restrictions on the use of the technique within the sector are indicated. These may be:</p> <ul style="list-style-type: none"> <li>• an indication of the type of plants or processes within the sector to which the technique cannot be applied;</li> <li>• constraints to implementation in certain generic cases, considering, e.g.: <ul style="list-style-type: none"> <li>• whether it concerns a new or an existing plant, taking into account factors involved in retrofitting (e.g. space availability) and interactions with techniques already installed</li> <li>• plant size, capacity or load factor</li> <li>• quantity, type or quality of product manufactured</li> <li>• type of fuel or raw material used.</li> </ul> </li> </ul> <p>These restrictions are indicated together with the reasons for them.</p> <p>These restrictions are not meant to be a list of the possible local conditions that could affect the applicability of the technique for an individual plant</p>
Economics	<p>Information on the costs (capital/investment, operating and maintenance including details on how these costs have been calculated/estimated) and any possible savings (e.g. reduced raw material or energy consumption, waste charges, reduced payback time compared to other techniques), or revenues or other benefits including details on how these have been calculated/estimated.</p> <p>The Reference Document on Economics and Cross-media Effects (ECM) and the Reference Document on the General Principles of Monitoring (MON) are taken into account with regard to economic aspects and monitoring costs, respectively.</p>
Driving force for implementation	<p>Where applicable, specific local conditions, requirements (e.g. legislation, safety measures) or non-environmental triggers (e.g. increased yield, improved product quality, economic incentives – e.g. subsidies, tax breaks) which have driven or stimulated the implementation of the technique to date.</p>
Example plants	<p>Reference to a plant(s) where the technique has been implemented and from which information has been collected and used in writing the section. An indication of the degree to which the technique is in use in the EU or worldwide.</p>
Reference literature	<p>Literature or other reference material (e.g. books, reports, studies) that was used in writing the section and that contains more detailed information on the technique. When the reference material consists of a large number of pages, reference will be made to the relevant page(s) or section(s).</p>

**Table 3.10: Information for each technique**

### **3.4.1 General considerations concerning consumption of raw materials**

Recycling and/or re-use of fine grain materials (application in shaft kilns and in combination with rotary kilns) and reduction and recycling of process losses/waste reduce the total consumption of raw materials.

### **3.4.2 General considerations concerning water**

Washing fluids used for wet washing go through a phased sedimentation process to separate the solid materials. Water is re-used and fed back into the fresh water circuit.

### **3.4.3 Reduction of energy consumption (energy efficiency)**

#### **Description**

An improved design of kilns, the optimisation of the process and the highest level of recovery and re-use of excess heat from kilns and coolers can reduce the consumption of energy and fuels. In addition, the use of oxygen (oxygen enriched combustion air) for the firing process can increase the efficiency of the firing process thus significantly improving the effectiveness of the kiln. This is coupled with a reduction in the air requirement and thus a reduction of the N<sub>2</sub> ballast in the kiln. The energy requirement can sustainably be reduced by this means.

Heat recovery from exhaust gases by the preliminary heating of the magnesite is used in order to minimise fuel energy use. Heat losses achieved from the kiln can be used for drying fuels, raw materials and some packaging materials.

Electrical energy use is minimised by utilisation of electricity based equipment with high energy efficiency.

#### **Achieved environmental benefits**

Reduction of energy usage and an increase in energy efficiency. As an additional effect, CO<sub>2</sub> emissions resulting from fuels are reduced when the process becomes more efficient.

#### **Cross-media effects**

An increase of NO<sub>x</sub> emissions may be caused by using a higher flame temperature for the burning process.

#### **Operational data**

Specific energy consumption of between 6 and 12 GJ/t has been reported. The theoretical reaction enthalpy of this highly endothermic process is 2803 MJ/kg (see Section 3.3.2).

#### **Applicability**

Reduction of energy consumption is, in principle, applicable to the magnesia industry.

#### **Economics**

Energy costs can constitute 35 – 40 % of total costs.

Reduction of energy consumption may reduce total costs and CO<sub>2</sub> emissions.

By using oxygen, the overall energy costs and energy balance have to be considered.

#### **Driving force for implementation**

Legal requirements.

Reduction of energy requirement and costs.

Reduction of CO<sub>2</sub> emissions.

Reduction of costs.

**Example plants and reference literature**

Plants in Austria, Spain and the EU-27.

In this context, useful information can also be found in the Energy Efficiency Techniques reference document (ENE).

[67, Austria, 2006], [109, RHI AG, 2006], [110, Spanish MgO producers, 2006/2008], [165, EUROMINES, 2006], [168, TWG CLM, 2007], [182, TWG CLM, 2008].

**3.4.4 Process control optimisation****Description**

A smooth and stable kiln process, operating close to the stoichiometric air required, is beneficial for all kiln emissions as well as energy use. Usually in practice, the excess of oxygen is about 1 – 3 % to obtain the required quality of the products and for optimal combustion. This can be obtained by applying process control optimisation. The firing process is optimised in order to reduce the heat consumption and to improve/keep the product quality of the sintered, caustic calcined or fused magnesia, such as by low specific energy consumption and low specific emissions. Generally, the kilns are equipped with a process control system for monitoring and controlling the whole process from a central point. Some parameters of the process are continuously recorded, such as energy consumption, temperature and sometimes NO<sub>x</sub>. Reduction of emissions, such as CO, NO<sub>x</sub>, SO<sub>2</sub> and dust, may be the secondary effects of this optimisation.

Since several different products are usually produced in the same kiln, the operating characteristics of the kiln have to be aligned with these products. The operating conditions for a kiln unit can vary greatly depending on loads and the quality produced.

**Achieved environmental benefits**

Reduction of emissions, such as CO, NO<sub>x</sub>, SO<sub>2</sub> and dust may be possible.

**Cross-media effects**

No issues.

**Operational data**

No data submitted.

**Applicability**

Process control optimisation is applicable to all kiln types used in the magnesia industry. However, a high sophisticated process control system may be necessary.

**Economics**

A complete process control system for a sinter plant or calcination plant has investment costs of about EUR 1 million.

**Driving force for implementation**

Legal requirements.

**Example plants and reference literature**

Plants in Austria, Spain and the EU-27.

[109, RHI AG, 2006], [110, Spanish MgO producers, 2006/2008], [165, EUROMINES, 2006].

### 3.4.5 Fuel selection

#### Description and operational data

The manufacture of magnesia using the dry process route is an energy intensive industry (see Section 3.3.2). The fuels mainly used in the EU are natural gas, petroleum coke and heavy fuel oil. However, coal (anthracite and lignite) can also be used in the firing process.

Careful selection and control of substances entering the kiln is necessary and can influence and reduce emissions, in particular SO<sub>2</sub>. Thus, fuels with low contents of sulphur should be selected if the price is reasonable and the fuel is available.

#### Achieved environmental benefits

Reduction of SO<sub>2</sub> emissions.

#### Cross-media effects

By using petcoke and hard coal for firing, SO<sub>2</sub> emissions may be increased in comparison to the use of natural gas and/or fuel oil (see Figure 3.13). Natural gas may generate higher NO<sub>x</sub> emissions due to higher flame temperatures; however, CO<sub>2</sub> emissions are lower due to a lower C:O-ratio of natural gas compared to coke or coal.

#### Operational costs

35 – 40 % of the production costs are related to energy costs.

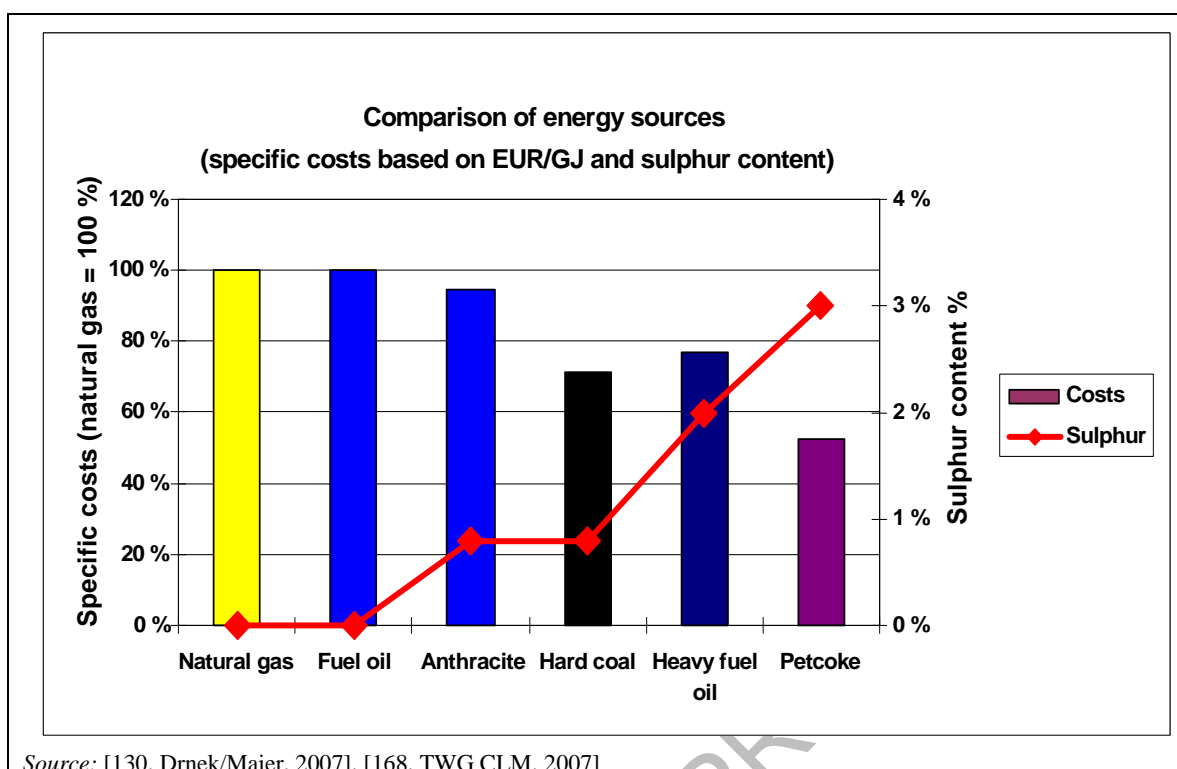
#### Applicability

The fuels can principally be used in kilns used for magnesia production. However, several fuels, e.g. natural gas, may not be available in all regions so that these techniques can only be applied where possible. The kiln has to be equipped with the fuel specific burning technique or lances. However, solid fuels, such as petcoke, are not applicable for shaft kilns with a rotating plate or a rotating grate, as they are described in Section 3.2.3.2.2.1 and Section 3.2.3.2.2.2.

In 2007, waste materials were not used as fuels due to the impurities which would then be covered by the product. The product has to be pure and clean, without any impurities. However, for the future and due to new techniques to co-incinerate waste materials and due to certain magnesia products, the magnesia industry considers the use of different types of waste, e.g. plastics or wood. In this context, general and quality control aspects for the use of waste in both the cement and lime manufacturing industries can be found in Sections 1.2.4 and 2.2.5 of this document respectively.

#### Economics

The comparison of different energy sources based on specific costs in EUR/GJ and the sulphur content from these fuels is shown in Figure 3.13. Petcoke contains the highest amount of sulphur followed by heavy fuel oil and then hard coal and anthracite.



**Figure 3.13: Fuel comparison with regard to specific costs and sulphur content**

There is a good relationship between efficiency and the price of petroleum coke (see Figure 3.13). However, energy costs have reached a high level of between 35 – 40 % and the economic factor has to be taken into consideration.

#### Driving force for implementation

Legal requirements.  
SO<sub>2</sub> reduction.

#### Example plants and reference literature

Plants in Austria, Spain and the EU-27.

[109, RHI AG, 2006], [110, Spanish MgO producers, 2006/2008], [165, EUROMINES, 2006], [168, TWG CLM, 2007], [182, TWG CLM, 2008].

### 3.4.6 Emissions of dust (particulate matter)

#### 3.4.6.1 Techniques for dusty operations

##### Description and achieved environmental benefits

Diffuse dust emissions mainly arise from the storage and handling of raw materials and fuels and from vehicles at the plant. Particulate releases from the packaging and dispatch of the product can also be significant. Simple and linear site layouts as well as organisational techniques are advisable to reduce and minimise possible sources of diffuse dust.

Several different techniques are presented here, which can be applied individually or in combination (see Section 3.3.3.1):

- good housekeeping of buildings and roads, along with proper and complete maintenance of the installation
- watering of raw material piles
- enclosure/encapsulation of dusty operations, such as grinding and screening

- covered conveyors and elevators, which are constructed as closed systems, if dust emissions are likely to be released from dusty material
- storage silos with adequate capacities and equipped with filters to deal with dust-bearing air displaced during filling operations
- a circulation process is favoured for pneumatic conveying systems
- reduction of air leakage and spillage points
- use of automatic devices and control systems
- use of continuous trouble free operations.

### **Cross-media effects**

Increase in energy consumption from the use of filter systems.

When maintenance is carried out, additional waste may occur.

Noise reduction is also possible by enclosing machinery.

### **Operational data**

No data submitted.

### **Applicability**

These techniques can, in principle, be carried out in the magnesia industry.

### **Economics**

Depending on the particular individual case related measure/technique.

### **Driving force for implementation**

Legal requirements.

Health and safety requirements for the workplace.

### **Example plants and reference literature**

Plants in Austria, Spain and the EU-27.

[109, RHI AG, 2006], [110, Spanish MgO producers, 2006/2008], [165, EUROMINES, 2006].

#### **3.4.6.2 Reduction of channelled dust emissions**

Dust emissions occur from the firing process, but also during the storage and handling of raw materials and fuels (e.g. conveyors or elevators), and from grinding and milling processes.

The following dedusting devices can be applied individually or in combination:

- electrostatic precipitators (ESPs)
- cyclones
- wet dust separators
- fabric filters.

In screening, grinding and milling units, fabric filters are used to collect the product and to dedust the conveying air.

Kilns used in the magnesia industry are generally equipped with techniques for dust reduction taking into account the relatively high exhaust gas temperatures from kiln firing. Of these kilns, several are equipped with electrostatic precipitators and/or a combination of a cyclone and an ESP and/or a cyclone and a wet scrubber, on account of the relatively high exhaust gas temperatures. Furthermore, fabric filters are used which are very efficient for the reduction of dust emissions. However, for the use of fabric filters, the high temperature of the flue-gas is very important and can be critical because, depending on the filter material used, it can inflame at higher temperatures.



#### 3.4.6.2.1 Electrostatic precipitators (ESPs)

##### **Description and achieved environmental benefits**

Electrostatic precipitators (ESPs) can be used for dust extraction for exhaust gas temperatures above the dew point and up to 370 – 400 °C. CO trips have to be avoided because of the explosion risks. CO is measured continuously for process control and safety reasons. The frequency of CO trips can be reduced by using modern process control systems with measuring and regulation devices that respond very quickly. Information and a guideline regarding the control of CO trips can be found in the cement chapter of this document, Section 1.4.5.3 and in Section 6.2.6.

More technical information and explanations about the operation of ESPs can be found in the cement chapter, Section 1.4.4.3.1 and in the lime chapter, Section 2.4.5.3.1. However, operational data related to ESPs used in the magnesia industry are shown below.

##### **Cross-media effects**

Explosion risks arise, particularly if dry ESP systems are applied.

The energy consumption increases due to the operation of the ESP compared to, e.g. the use of cyclones.

When maintenance is carried out, additional waste may occur.

##### **Operational data**

By an entry temperature of the flue-gases to the ESP of approximately 400 °C, dust emissions of 75 mg/Nm<sup>3</sup> have been observed, measured discontinuously as an average value from one week per year. However, ESPs are able to achieve dust emission levels of less than 10 mg/Nm<sup>3</sup>, depending on the operational mode.

##### **Applicability**

ESPs are mainly used in rotary kilns.

They can be used for exhaust gas temperatures above the dew point and up to 370 – 400 °C.

##### **Economics**

Relatively high operational costs have to be taken into consideration when operating an ESP.

##### **Driving force for implementation**

Process requirements.

Legal requirements.

##### **Example plants and reference literature**

Two plants in the EU-27.

[67, Austria, 2006], [109, RHI AG, 2006] [110, Spanish MgO producers, 2006/2008], [165, EUROMINES, 2006], [168, TWG CLM, 2007], [182, TWG CLM, 2008].

#### 3.4.6.2.2 Centrifugal separators/cyclones

##### **Description and achieved environmental benefits**

Cyclones use centrifugal force to separate particulate matter from the gas flow. They are robust and they have a wide operational temperature range with a low energy requirement [86, EURITS, 2006].

In a centrifugal separator, the dust particles to be eliminated from an off-gas stream are forced out against the outer wall of the unit by centrifugal action and then eliminated through an aperture at the bottom of the unit. Centrifugal forces can be developed by directing the gas flow in a downward spiral motion through a cylindrical vessel (cyclonic separators) or by a rotating impeller fitted in the unit (mechanical centrifugal separators).

### **Cross-media effects**

The operation of centrifugal separators/cyclones is a significant noise source. When maintenance is carried out, additional waste may occur.

### **Operational data**

In other sectors, such as in the lime industry, centrifugal separators/cyclones are used as pre-separators/product separators. They can typically only achieve dust emission values of less than 150 mg/Nm<sup>3</sup> (see Section 2.4.5.3.4). In the cement industry, cyclones are combined with an air/heat exchanger for temperature reduction and a fabric filter for dust removal from, e.g. cooling exhaust gases. A cyclone can reduce the dust concentration by 70 %. In combination with an air heat exchanger and a fabric filter, high cleaning efficiencies of up to 99.99 % are achievable along with low emission values of 5 – 7 mg/Nm<sup>3</sup> and these have been reported from a cement plant in South Africa (see cement chapter, Section 1.4.4.3.2).

Centrifugal separators perform more efficiently with higher pollutant loadings, provided that the device does not become blocked.

### **Applicability**

Particles with a low grain sizes are not effectively retained by centrifugal separators/cyclones. Because of the system-dependent limited degree of separation, cyclones are mainly used as preliminary separators for coarse dust and exhaust gases.

### **Economics**

Centrifugal separators/cyclones are relatively inexpensive and easy to operate.

### **Driving force for implementation**

Legal requirements.  
Process requirements.

### **Example plants and reference literature**

Plants in Austria, Spain and the EU-27.  
[86, EURITS, 2006], [109, RHI AG, 2006], [110, Spanish MgO producers, 2006/2008], [165, EUROMINES, 2006], [168, TWG CLM, 2007], [182, TWG CLM, 2008].

#### **3.4.6.2.3 Wet dust separators**

##### **Description and achieved environmental benefits**

With wet dust separators, dust is eliminated from off-gas streams. Wet dust separators (also called wet scrubbers) can be divided into various types according to their design and working principles, such as the venturi type. This type of wet dust separator has a number of applications in the magnesia industry, including when gas is directed through the narrowest section of the venturi tube, the so-called 'venturi neck', and gas velocities of between 60 and 120 m/s can be achieved. The washing fluids which are fed into the venturi tube neck are diffused into a mist of very fine droplets and are intensively mixed with the gas. The particles separated onto the water droplets become heavier and can be readily drawn off using a drop separator installed in this venturi wet dust separator.

##### **Cross-media effects**

With the wet separation technique, pollutants are transferred from air to water so a second installation for cleaning the wet waste product (suspension) is essential, and therefore additional energy consumption is also possible.

##### **Operational data**

When operated efficiently, modern multi-cascade wet scrubbers can achieve clean gas concentrations of between 10 and 20 mg/Nm<sup>3</sup> (see Section 2.4.5.3.3 of the lime chapter).

**Applicability**

This venturi type of wet dust separator removes dust, volatile substances, HCl and SO<sub>2</sub> from the exhaust gas stream. No disadvantages or side effects are caused by implementing this technique.

**Economics**

Regarding operating costs, scrubbing liquid and process waste water cleaning both have to be taken into consideration.

**Driving force for implementation**

Process requirements.

Legal requirements.

**Example plants and reference literature**

Two plants in the EU-27.

[109, RHI AG, 2006], [110, Spanish MgO producers, 2006/2008], [165, EUROMINES, 2006], [168, TWG CLM, 2007].

**3.4.6.2.4 Fabric filters****Description and achieved environmental benefits**

In a fabric filter, the off-gas is passed through a filter bag and the dust particles are deposited on the filter surface in form of a filter cake. Fabric filters receive high particle retention, typically over 98 and up to 99 % depending on the particle size. This technique offers the best efficiency on particle collection in comparison to other dust abatement techniques used in the magnesia industry. However, because of the high temperatures of the kiln exhaust gases, special filter materials which can tolerate high temperatures have to be used.

**Cross-media effects**

Operation of fabric filters, especially with pressure pulse regeneration, may cause noise emissions and they might also increase the electricity consumption due to their high pressure drop. When maintenance is carried out, additional waste may occur.

**Operational data**

Fabric filters are available in different types of woven filters and some of them can operate with, and tolerate, quite high temperatures. Information about the technical application of different types of fabrics can be found in Section 1.4.4.3.2 (cement chapter) of this document.

From dusty operations other than from the kiln firing process, dust emissions ranges of less than 5 – 10 mg/Nm<sup>3</sup> can be achieved in other sectors by using fabric filters. For well designed, operated and maintained fabric filters (continuously dedusting of the filter bags), dust emissions of less than 10 mg/Nm<sup>3</sup> are achieved in the lime industry (see 2.4.5.3.2). The separation efficiency can be higher than 99.9 %, and therefore emissions of less than 5 mg/Nm<sup>3</sup> can be achieved (dry gas, 273 K, 10 % O<sub>2</sub>) in the cement industry (see 1.4.4.3.2).

Furthermore in the magnesium oxide industry, dust emission levels of less than 20 mg/Nm<sup>3</sup> were reported from kiln firing processes by using fabric filters [110, Spanish MgO producers, 2006/2008].

**Applicability**

Fabric filters for dust removal from off-gases can, in principle, be applied for all units in the magnesium oxide manufacturing process, especially for dusty operations, screening, grinding and milling. They can be used for exhaust gas temperatures above the dew point and up to 280 °C.

Because of the high temperatures of the exhaust gases of between 250 and 400 °C and the corrosive nature and the high volume of the exhaust gases occurring from the kiln firing process for the production of caustic calcined magnesia (CCM) and sintered/dead burned magnesia

(DBM), special fabric filters with high temperature resistant filter material have to be used. However, experience from the magnesia industry producing DBM shows that no suitable equipment, e.g. filter material, is available for exhaust gas temperatures of approximately 400 °C for magnesia production.

In DBM manufacture, filter materials operating with temperatures up to 250 °C are used, such as PTFE (Teflon) filter material. This filter material shows good resistance to acids or alkalis and a lot of corrosion problems have been solved [110, Spanish MgO producers, 2006/2008].

### **Economics**

The investment costs of filter materials tolerating high flue-gas temperatures are relatively high in comparison to other filter material.

The operational costs are higher for fabric filters than for ESPs because of the higher pressure drop of the filter materials.

Information about the technical application and costs of different types of fabrics can be found in Section 1.4.4.3.2 (cement chapter) of this document.

### **Driving force for implementation**

Legal requirements.

### **Example plants and reference literature**

Three plants in the EU-27.

[109, RHI AG, 2006], [110, Spanish MgO producers, 2006/2008], [165, EUROMINES, 2006], [168, TWG CLM, 2007], [182, TWG CLM, 2008].

## **3.4.7 Gaseous compounds**

### **3.4.7.1 Reduction of NO<sub>x</sub> emissions**

#### **Description**

The significant influential factor for NO<sub>x</sub> emissions is the firing temperature which is necessary for the firing process in the magnesia industry. Generally, this has a direct relationship to the quality of the sintered/dead burned magnesia produced. This firing temperature is generally very high compared to other applications of the same unit. However, the firing temperatures vary depending on the product. Because of the characteristics of the product that has to be produced and the direct relationship between the product and the firing temperature, this firing temperature cannot be reduced.

There is one source for the formation of NO<sub>x</sub>:

- thermal NO<sub>x</sub> is due to the reaction at high temperatures between N<sub>2</sub> and O<sub>2</sub> from the combustion air.

Thermal NO<sub>x</sub> forms at temperatures above 1000 °C, i.e. in the burning zone of the kiln, where the temperatures are sufficiently high. The amount of thermal NO<sub>x</sub> produced increases with higher temperatures and growing oxygen contents in the burning zone.

Different techniques can be used to reduce NO<sub>x</sub> emissions, such as primary or secondary techniques or a combination of both. Primary techniques reduce the formation of NO<sub>x</sub> while secondary techniques destroy nitrogen oxide and reduce them to N<sub>2</sub>.

Primary techniques are process-integrated techniques and involve in particular:

- process optimisation
- improved firing technique
- staged combustion/air staging
- burner design.

In 2007, no stage combustion was used in the magnesium oxide industry.

Secondary techniques for NO<sub>x</sub> reduction involve as follows:

- selective non-catalytic reduction (SNCR)
- selective catalytic reduction (SCR).

In 2007, no secondary techniques for the reduction of NO<sub>x</sub> were used in the magnesium oxide industry.

#### **Achieved environmental benefits**

Reduction of NO<sub>x</sub> emissions.

#### **Cross-media effects**

As shown in Section 1.4.5.1.7 and in Section 2.4.6.1.4 (cement chapter), if SNCR is considered to be used the ammonia slip has also to be considered. The relationship between temperature, NH<sub>3</sub> slip and NO<sub>x</sub> reduction are shown in Figure 2.50 (see Section 2.4.6.1.4 of the lime chapter) [46, Germany, 2006]. However, in 2008, no SNCR technique is used in the magnesia industry (see applicability).

#### **Operational data**

See Section 3.3.3.1 and Table 3.9. By using only primary NO<sub>x</sub> reduction techniques, NO<sub>x</sub> emissions of between 650 – 2500 mg/Nm<sup>3</sup> were reported in 2006. However, the higher value is related to the high temperature DBM process.

#### **Applicability**

##### *Primary techniques*

Primary techniques are, in principle, applicable to most types of kilns used for magnesia manufacture.

However, some primary techniques used in other industries cannot be used in the magnesia industry, such as low NO<sub>x</sub> burners and flame cooling. Low NO<sub>x</sub> burners are not/cannot be used because of the high firing temperature which is necessary for DBM production. This type of burner operates with temperatures at a maximum of 1600 °C while the firing temperature for DBM production is up to 2200 °C. Flame cooling is/can also not be used because of these high temperatures.

To be used in the magnesia industry, stage combustion/air staging has to be further developed. In 2007, no stage combustion was used in the magnesium oxide industry.

##### *Secondary techniques*

In the EU-27 in 2008, *selective non-catalytic reduction (SNCR)* for NO<sub>x</sub> reduction was not used in the magnesia industry because the SNCR technique operates within a temperature window of between 800 – 1000 °C while the DBM production process is an endothermic process which does not reach this temperature window. During the process where the material is de-acidified, the temperature is in a range of between 500 and 800 °C. A stable temperature above 800 °C is not achievable without high amounts of energy which additionally has to be used in order to achieve the temperature where the SNCR technique operates. Beside others, a significant increase in additional energy costs would arise.

From the evaluation study carried out in the late 1990s, it appeared that *selective catalytic reduction (SCR)* for NO<sub>x</sub> reduction in the DBM industry was uncertain technically as well as economically. This was mainly due to the uncertainty in the life-time of the catalysts and the strong pollutive nature of the off-gases [108, European Commission, 2006].

The SCR technique operates in a temperature window of between 300 and 400 °C. NO and NO<sub>2</sub> is reduced to N<sub>2</sub> by using NH<sub>3</sub> and a catalyst. The process requires a good mixing of the flue-gas and the agent, an optimised injection temperature and a sufficient residence time in the window of optimal temperatures.

In the EU-27 in 2008, SCR technique for NO<sub>x</sub> reduction was not used in the magnesia industry. The catalysts are very sensitive to magnesia. Because of a high dust load, the exhaust gas has to be dedusted, e.g. by using fabric filters, before passing the catalysts of the SCR. However, because of the high temperature needed, the exhaust gas has to be cooled down to a maximum of 250 °C before being dedusted by special fabric filters. For the use of the SCR technique, the exhaust gas has then to be reheated to the temperature window of between 300 and 400 °C where the SCR operates. This requires additional energy and may cause additional emissions, e.g. CO<sub>2</sub>.

### **Economics**

Catalytic processes usually involve high investment costs.

### **Driving force for implementation**

Legal requirements.

### **Example plants and reference literature**

Magnesia plants in the EU-27 using primary techniques for NO<sub>x</sub> emissions reduction. [46, Germany, 2006], [54, EuLA, 2006], [85, CEMBUREAU, 2006], [108, European Commission, 2006], [109, RHI AG, 2006], [110, Spanish MgO producers, 2006/2008], [165, EUROMINES, 2006], [168, TWG CLM, 2007], [182, TWG CLM, 2008].

### **3.4.7.2 Reduction of CO emissions**

#### **Description and achieved environmental benefits**

The selection, if possible, of raw materials with a low content of organic matter also reduces CO emissions. Continuous controlling of the firing temperature and controlled fuel addition can also influence CO emissions, e.g.:

- using weight feeders and precision rotary valves for petcoke feeding and/or
- using flowmeters and precision valves for heavy oil or gas feeding regulation to the kiln burner.

A complete and correct combustion is essential to reduce CO emissions. Air supply from cooler and primary air as well as the draught of the stack fan can be controlled in order to keep an oxygen level of between 1 (sinter) and 1.5 % (caustic) during the combustion. Periodic flue-gas analysis can detect high concentrations of CO (150 mg/Nm<sup>3</sup>) while a change of air and fuel charge can reduce these emissions.

Furthermore, CO emissions can be decreased by changing the depth of the burner [108, European Commission, 2006]. CO emissions are measured in order to optimise the process (process optimisation) and to check the combustion (100 % combustion) of the fuels.

In some cases and under certain circumstances, the CO trip management measure/technique that has been developed for cement kilns which are equipped with ESPs may also be applicable to the magnesia industry. Information and a guideline regarding the control of CO trips can be found in the cement chapter of this document, Section 1.4.5.3 and in Section 6.2.6.

**Cross-media effects**

No issues.

**Operational data**

CO emissions of between 33 and 1000 mg/Nm<sup>3</sup> were reported.

Total CO<sub>2</sub> per tonne MgO product is the sum of process CO<sub>2</sub> and fuel related CO<sub>2</sub>. The CO<sub>2</sub> proportion which originates from the fuel is, depending on the product, in a range of 0.35 – 0.59 t<sub>CO2</sub>/t<sub>MgO</sub> for gas and about 0.813 t<sub>CO2</sub>/t<sub>MgO</sub> for ‘OECD mix’. The CO<sub>2</sub> proportion which originates from the process is 1 t<sub>CO2</sub>/t<sub>MgO</sub> (calcination of magnesite to magnesium oxide).

**Applicability**

This measure/technique is, in principle, applicable to the magnesia industry.

**Economics**

No data submitted.

**Driving force for implementation**

Legal requirements.

**Example plants and reference literature**

Magnesia plants in the EU-27.

[46, Germany, 2006], [54, EuLA, 2006] [85, CEMBUREAU, 2006], [108, European Commission, 2006], [109, RHI AG, 2006], [110, Spanish MgO producers, 2006/2008], [165, EUROMINES, 2006], [168, TWG CLM, 2007], [182, TWG CLM, 2008].

**3.4.7.3 Reduction of SO<sub>2</sub> emissions****Description**

SO<sub>2</sub> emissions mainly depend on the content of sulphur in the fuel. Emissions of sulphur from the raw material (magnesite) depend on the content of sulphur in the raw material. They are, in principle, low because of the low content of sulphur in most of the raw materials. However, in some cases the SO<sub>2</sub> emissions from raw materials can be 50 and up to 100 % of the total SO<sub>2</sub> emissions.

In the magnesia industry, different flue-gas desulphurisation techniques are used for SO<sub>2</sub> reduction, such as:

- wet dust separator (wet scrubber)
- spray dry scrubber
- sorbent injection process (injection of solid or liquid adsorbents in the flue-gas stream)
- regenerating process.

Technical information and explanations about the operation of wet scrubbers can be found in the cement chapter, Section 1.4.5.2.2.

By using the sorbent injection process, a sufficient gas residence time between the injection point and the dust collector is very important to obtain highly efficient absorption. Reactive MgO grades are already being used as efficient sorbents for SO<sub>2</sub> in other sectors, e.g. thermal power generation plants. Despite its lower efficiency compared to other techniques, the use of this measure/technique in the magnesia industry has a double advantage: lower investment costs and the filter dust is not contaminated by other substances. The collected filter dust can then be re-used and added to the products in order to minimise waste generation.

Furthermore, technical information and explanations about the sorbent injection process (adsorbent addition) in other sectors can be found in the cement chapter in Section 1.4.5.2.1 and in the lime chapter in Section 2.4.6.2 of this document.

### **Achieved environmental benefits**

Reduction of SO<sub>2</sub> emissions. Volatile substances and dust emissions along with HCl and SO<sub>2</sub> emissions can be reduced by using wet dust separators using a venturi scrubber.

### **Cross-media effects**

Minimisation of waste generation (re-use of the filter dust).

By using wet dust separators (wet scrubbers), emissions to water may occur.

### **Operational data**

By using sulphur rich fuels, such as petcoke, and a wet scrubber for SO<sub>2</sub> abatement, SO<sub>2</sub> emissions in a range of between 17.1 – 50 mg/Nm<sup>3</sup> are observed from spot measurements. By using natural gas, SO<sub>2</sub> emission levels of 10 mg/Nm<sup>3</sup> has been achieved [109, RHI AG, 2006].

By producing caustic magnesia in a rotary kiln, about 40 % of the sulphur dioxide resulting from the fuel is recovered mainly from the filter dust.

### **Applicability**

These techniques can, in principle, be carried out in the magnesia industry. As described in Section 3.4.6.2.3, wet dust separators using a venturi scrubber, along with HCl and SO<sub>2</sub>, also remove volatile substances and dust. This measure/technique is considered to be efficient in other sectors.

In order to obtain highly efficient absorption by using the sorbent injection process, a sufficient gas residence time between the injection point and the dust collector is very important.

### **Economics**

In the MgO industry, the installation of a wet scrubber may involve investment costs of about EUR 2 million – 3 million. Furthermore, example cost data for SO<sub>x</sub> abatement measure/techniques in the cement industry can be found in Sections 1.4.5.2 and 1.4.8.3 of this document.

Depending on the measure/technique used, flue-gas desulphurisation processes may involve high investments costs.

### **Driving force for implementation**

Legal requirements.

### **Example plants and reference literature**

Plants in Austria, Spain and EU-27.

[109, RHI AG, 2006] [110, Spanish MgO producers, 2006/2008], [165, EUROMINES, 2006], [168, TWG CLM, 2007], [182, TWG CLM, 2008].

## **3.4.8 General considerations concerning process losses/waste**

Process losses, such as various types of magnesium carbonate dusts which are collected should be recycled back into the production processes whenever practicable or should be re-used in marketable products. Furthermore, sludge resulting from the wet process of flue-gas desulphurisation (settling and/or filtration methods) should be re-used in the process or in other sectors if possible due to specification.

Alternative uses may be found for material that cannot be recycled, e.g. packaging waste materials or wastes resulting from the maintenance of certain installation devices.



### 3.4.9 Noise

#### Description and achieved environmental benefits

The extraction and processing of raw material as well as DBM production inevitably includes noisy operations. Noise emissions occur throughout the whole process and can arise at different stages of the process, such as from crushing and milling units, grinding and preparation units, from the kilns and the feeding systems of the kilns, belt conveyors, filter units, the cooling systems of the kilns, etc. The operation of large and heavy machinery and large fans can give rise to noise and/or vibration emissions. By directly applying techniques at the source of the noise, a reduction of these emissions can often be achieved, such as:

- enclosure of the noisy unit
- minimising noise by using soundproofed buildings
- lagging of ducts and finally blowers which are situated in soundproofed buildings
- noise protection walls
- outlet silencers for exhaust stacks
- silencers for fans of filters
- use of soundproofed modules for technical devices (e.g. compressors)
- using rubber shields for mills (avoiding the contact of metal against metal).

If the above-mentioned noise protection techniques cannot be applied and if a transfer of noisy units inside a building is not possible, e.g. because of the sizes of kilns and their facilities, secondary noise protection techniques, e.g. constructing buildings or growing trees and bushes between the protected area and the noisy activity (the kiln or the storage area) have to be carried out. Doors and windows of covered areas have to be kept closed during noisy operations. Natural noise barriers, such as office buildings, walls, trees or bushes may be used in order to reduce noise emissions. Plants are required to comply with reduction of noise standards in compliance with national legislation.

More information about noise abatement and a noise abatement scheme can be found in the lime Chapter in Section 2.4.10 of this document.

#### Cross-media effects

Additional investment and maintenance costs can occur due to the noise protection techniques.

#### Operational data

No data available.

#### Applicability

Techniques for noise reduction can, in principle, be applicable to the magnesia industry (see Section 3.3.3.4).

#### Economics

Additional investment costs can occur due to the noise protection techniques.

#### Driving force for implementation

Legal requirements.

#### Example plants and reference literature

Magnesium oxide (magnesia) plants in Austria, Spain and the EU-27.

More information about noise abatement and a noise abatement scheme can be found in the lime Chapter, Section 2.4.10.

[45, Schorcht, 2006] [109, RHI AG, 2006], [110, Spanish MgO producers, 2006/2008], [165, EUROMINES, 2006].

### 3.4.10 Environmental management tools

Environmental management tools are described in the cement chapter in Section 1.4.12 of this document.

**\*\*NOTE to Article 13 Forum members: Section 1.5 that included the BAT conclusions have been deleted and replaced by Chapter 4\*\***

WORKING DRAFT IN PROGRESS

### 3.5 Emerging techniques

No emerging techniques for the magnesium oxide industry using the dry process route have been provided yet.

**\*\*NOTE to Article 13 Forum members: Section 3.7 of the CLM BREF has been moved to Chapter 5 – Concluding remarks and recommendations for future work\*\***

WORKING DRAFT IN PROGRESS

---

WORKING DRAFT IN PROGRESS

---

## 4 BAT CONCLUSIONS

### SCOPE

These BAT conclusions concern the following industrial activities specified in Section 3.1 of Annex I to Directive 2010/75/EU, namely:

'3.1. Production of cement, lime and magnesium oxide', which involve:

- (a) production of cement clinker in rotary kilns with a production capacity exceeding 500 tonnes per day or in other kilns with a production capacity exceeding 50 tonnes per day;
- (b) production of lime in kilns with a production capacity exceeding 50 tonnes per day;
- (c) production of magnesium oxide in kilns with a production capacity exceeding 50 tonnes per day.

Regarding point 3.1(c) above, these BAT conclusions only address the production of MgO using the dry process route based on mined natural magnesite (magnesium carbonate  $MgCO_3$ ).

In particular, concerning the activities reported above, these BAT conclusions cover the following:

- production of cement, lime and magnesium oxide (dry process route)
- raw materials – storage and preparation
- fuels – storage and preparation
- use of waste as raw materials and/or fuels, quality requirements, control and preparation
- products – storage and preparation
- packaging and dispatch.

These BAT conclusions do not address the following activities:

- the production of magnesium oxide using the wet process route using magnesium chloride as the starting material, covered by the Reference Document on Best Available Techniques for Large Volume Inorganic Chemicals – Solids and Others Industry (LVIC-S)
- the production of ultra low-carbon dolime
- shaft kilns for cement clinker production
- activities which are not directly associated with the primary activity such as quarrying (covered in the Reference Document on Best Available Techniques for the Management of Tailings and Waste-rock in Mining Activities).

Other reference documents which are of relevance for the activities covered by these BAT conclusions are the following:

Reference documents	Activity
Emissions from Storage (EFS)	Storage and handling of raw materials and products
General Principles of Monitoring (MON)	Emissions monitoring
Waste Treatments Industries (WT)	Waste treatment
Energy Efficiency (ENE)	General energy efficiency
Economic and Cross-media Effects (ECM)	Economics and cross-media effects of techniques

The techniques listed and described in these BAT conclusions are neither prescriptive nor exhaustive. Other techniques may be used that ensure at least an equivalent level of environmental protection.

Where these BAT conclusions address waste co-incineration plants, this is without prejudice to the provisions of Chapter IV of and Annex VI to Directive 2010/75/EU.

## DEFINITIONS

For the purposes of these BAT conclusions, the following definitions are given:

Term used	Definition
New plant	A plant introduced on the site of the installation following the publication of these BAT conclusions or a complete replacement of a plant on the existing foundations of the installation following the publication of these BAT conclusions
Existing plant	A plant which is not a new plant
Major upgrade	An upgrade of the plant/kiln involving a major change in the kiln requirements or technology, or replacement of the kiln
'Use of waste as fuel and/or raw material'	The term covers the use of : <ul style="list-style-type: none"> <li>• waste fuels with significant calorific value; and</li> <li>• waste materials without significant calorific value but with mineral components used as raw materials that contribute to the intermediate product clinker; and</li> <li>• waste materials that have both a significant calorific value and mineral components</li> </ul>

### Definition for certain products

Term used	Definition
White cement	Cement falling under the following PRODCOM code: 26.51.12.10 – White Portland cement
Special cement	Cement falling under the following PRODCOM codes: <ul style="list-style-type: none"> <li>• 26.51.12.50 – Alumina cement</li> <li>• 26.51.12.90 – Other hydraulic cements</li> </ul>
Sintered dolime	A mixture of calcium and magnesium oxides (CaO >58 % and MgO > 41%) used solely for the production of refractory materials, with a minimum bulk density of 3.05 g/cm <sup>3</sup>
Ultra low-carbon dolime (ULCD)	A mixture of calcium and magnesium oxides produced by the nearly full decarbonation of dolomite (CaCO <sub>3</sub> .MgCO <sub>3</sub> ). The residual CO <sub>2</sub> content of the product is below 0.25 % and the bulk density well below 3.05 g/cm <sup>3</sup>

### Definition for certain air pollutants

Term used	Definition
NO <sub>x</sub> expressed as NO <sub>2</sub>	The sum of nitrogen oxide (NO) and nitrogen dioxide (NO <sub>2</sub> ) expressed as NO <sub>2</sub>
SO <sub>x</sub> expressed as SO <sub>2</sub>	The sum of sulphur dioxide (SO <sub>2</sub> ) and sulphur trioxide (SO <sub>3</sub> ) expressed as SO <sub>2</sub>
Hydrogen chloride expressed as HCl	All gaseous chlorides expressed as HCl
Hydrogen fluoride expressed as HF	All gaseous fluorides expressed as HF

## Abbreviations

ASK	Annular shaft kiln
DBM	Dead burned magnesite
I-TEQ	International toxicity equivalent
LRK	Long rotary kiln
MFSK	Mixed feed shaft kiln
OK	Other kilns Other kilns in the lime industry are: <ul style="list-style-type: none"> <li>• double-inclined shaft kilns</li> <li>• multi-chamber shaft kilns</li> <li>• central burner shaft kilns</li> <li>• external chamber shaft kilns</li> <li>• beam burner shaft kilns</li> <li>• internal arch shaft kilns</li> <li>• travelling grate kilns</li> <li>• 'top-shaped' kilns</li> <li>• flash calciner kilns</li> <li>• rotating hearth kilns</li> </ul>
OSK	Other shaft kiln (shaft kilns other than ASK and MFSK)
PCDD	Polychlorinated dibenzo-p-dioxin
PCDF	Polychlorinated dibenzofuran
PFRK	Parallel flow regenerative kiln
PRK	Rotary kiln with preheater

## GENERAL CONSIDERATIONS

### Averaging periods and reference conditions for air emissions

Emission levels associated with the best available techniques (BAT-AELs) given in these BAT conclusions refer to standard conditions: dry gas at a temperature of 273 K, and a pressure of 1013 hPa. Values given in concentrations apply under the following reference conditions:

Activities		Reference conditions
Kiln activities	Cement industry	10 % oxygen by volume
	Lime industry <sup>(1)</sup>	11 % oxygen by volume
	Magnesium oxide industry (dry process route) <sup>(2)</sup>	10 % oxygen by volume
Non-kiln activities	All processes	No correction for oxygen
	Lime hydrating plants	As emitted (no correction for oxygen and for dry gas)

<sup>(1)</sup> For sintered dolime produced by the 'double pass process', the correction for oxygen does not apply.  
<sup>(2)</sup> For dead burned magnesia (DBM) produced by 'double pass process', the correction for oxygen does not apply.

The following definitions are given for averaging periods:

Daily average value	Average value over a period of 24 hours measured by the continuous monitoring of emissions
Average over the sampling period	Average value of spot measurements (periodic) of at least 30 minutes each, unless otherwise stated

### Monitoring of emissions

BAT-AELs given in these BAT conclusions refer to the monitoring of emissions carried out in accordance with EN or ISO standards or other national/international standards that ensure the provision of data of an equivalent scientific quality.

### Conversion to reference oxygen concentration

The formula for calculating the emissions concentration at a reference oxygen level is shown below:

$$E_R = \frac{21 - O_R}{21 - O_M} * E_M$$

Where:

$E_R$  (mg/Nm<sup>3</sup>): emissions concentration related to the reference oxygen level  $O_R$

$O_R$  (vol %): reference oxygen level

$E_M$  (mg/Nm<sup>3</sup>): emissions concentration related to the measured oxygen level  $O_M$

$O_M$  (vol %): measured oxygen level



## 4.1 General BAT conclusions

The BAT mentioned in this section applies to all installations covered by these BAT conclusions (cement, lime and magnesium oxide industry).

The process-specific BAT included in Sections 4.2 - 4.4 apply in addition to the general BAT mentioned in this section.

### 4.1.1 Environmental management systems (EMS)

**1. In order to improve the overall environmental performance of the plants/installations producing cement, lime and magnesium oxide, production BAT is to implement and adhere to an environmental management system (EMS) that incorporates all of the following features:**

- i. commitment of the management, including senior management;
- ii. definition of an environmental policy that includes the continuous improvement of the installation by the management;
- iii. planning and establishing the necessary procedures, objectives and targets, in conjunction with financial planning and investment;
- iv. implementation of procedures paying particular attention to:
  - (a) structure and responsibility
  - (b) training, awareness and competence
  - (c) communication
  - (d) employee involvement
  - (e) documentation
  - (f) efficient process control
  - (g) maintenance programmes
  - (h) emergency preparedness and response
  - (i) safeguarding compliance with environmental legislation;
- v. checking performance and taking corrective action, paying particular attention to:
  - (a) monitoring and measurement (see also the Reference Document on the General Principles of Monitoring)
  - (b) corrective and preventive action
  - (c) maintenance of records
  - (d) independent (where practicable) internal and external auditing in order to determine whether or not the EMS conforms to planned arrangements and has been properly implemented and maintained;
- vi. review of the EMS and its continuing suitability, adequacy and effectiveness by senior management;
- vii. following the development of cleaner technologies;
- viii. consideration for the environmental impacts from the eventual decommissioning of the installation at the stage of designing a new plant, and throughout its operating life;
- ix. application of sectoral benchmarking on a regular basis.

#### Applicability

The scope (e.g. level of details) and nature of the EMS (e.g. standardised or non-standardised) will generally be related to the nature, scale and complexity of the installation, and the range of environmental impacts it may have.

### 4.1.2 Noise

2. In order to reduce/minimise noise emissions during the manufacturing processes for cement, lime and magnesium oxide, BAT is to use a combination of the following techniques:

	Technique
a	Select an appropriate location for noisy operations
b	Enclose noisy operations/units
c	Use vibration insulation of operations/units
d	Use internal and external lining made of impact-absorbent material
e	Use soundproofed buildings to shelter any noisy operations involving material transformation equipment
f	Use noise protection walls and/or natural noise barriers
g	Use outlet silencers to exhaust stacks
h	Lag ducts and final blowers which are situated in soundproofed buildings
i	Close doors and windows of covered areas
j	Use sound insulation of machine buildings
k	Use sound insulation of wall breaks, e.g. by installation of a sluice at the entrance point of a belt conveyor
l	Install sound absorbers at air outlets, e.g. the clean gas outlet of dedusting units
m	Reduce flow rates in ducts
n	Use sound insulation of ducts
o	Apply the decoupled arrangement of noise sources and potentially resonant components, e.g. of compressors and ducts
p	Use silencers for filter fans
q	Use soundproofed modules for technical devices (e.g. compressors)
r	Use rubber shields for mills (avoiding the contact of metal against metal)
s	Construct buildings or growing trees and bushes between the protected area and the noisy activity

## 4.2 BAT conclusions for the cement industry

Unless otherwise stated, the BAT conclusions presented in this section can be applied to all installations in the cement industry.

### 4.2.1 General primary techniques

3. In order to reduce emissions from the kiln and use energy efficiently, BAT is to achieve a smooth and stable kiln process, operating close to the process parameter set points by using the following techniques:

	Technique
a	Process control optimisation, including computer-based automatic control
b	Using modern, gravimetric solid fuel feed systems

4. In order to prevent and/or reduce emissions, BAT is to carry out a careful selection and control of all substances entering the kiln.

#### Description

Careful selection and control of substances entering the kiln can reduce emissions. The chemical composition of the substances and the way they are fed in the kiln are factors that should be taken into account during the selection. Substances of concern may include the substances mentioned in BAT 11 and in BAT 24 to 28.

### 4.2.2 Monitoring

5. BAT is to carry out the monitoring and measurements of process parameters and emissions on a regular basis including the following:

	Technique	Applicability
a	Continuous measurements of process parameters demonstrating the process stability, such as temperature, O <sub>2</sub> content, pressure and flow rate	Generally applicable
b	Monitoring and stabilising critical process parameters, i.e. homogenous raw material mix and fuel feed, regular dosage and excess oxygen	Generally applicable
c	Continuous measurements of NH <sub>3</sub> emissions when SNCR is applied	Generally applicable
d	Continuous measurements of dust, NO <sub>x</sub> , SO <sub>x</sub> , and CO emissions	Applicable to kiln processes
e	Periodic measurements of PCDD/F and metal emissions	
f	Continuous or periodic measurements of HCl, HF and TOC emissions.	
g	Continuous or periodic measurements of dust	Applicable to non-kiln activities.  For small sources (<10 000 Nm <sup>3</sup> /h) from dusty operations other than cooling and the main milling processes, the frequency of measurements or performance check should be based on a maintenance management system.

**Description**

The selection between continuous or periodic measurements mentioned in BAT 5 (f) is based on the emission source and the type of pollutant expected.

**4.2.3 Energy consumption and process selection****4.2.3.1 Process selection**

6. In order to reduce energy consumption, BAT is to use a dry process kiln with multistage preheating and precalcination.

**Description**

In this type of kiln system, exhaust gases and recovered waste heat from the cooler can be used to preheat and pre-calcine the raw material feed before entering the kiln providing significant savings in energy consumption.

**Applicability**

Applicable to new plants and major upgrades, subject to raw materials moisture content.

**BAT-associated energy consumption levels**

See Table 4.1.

**Table 4.1: BAT-associated energy consumption levels for new plants and major upgrades using dry process kiln with multistage preheating and precalcination**

Process	Unit	BAT-associated energy consumption levels <sup>(1)</sup>
Dry process with multistage preheating and precalcination	MJ/tonne clinker	2900 – 3300 <sup>(2)</sup> <sup>(3)</sup>
<p><sup>(1)</sup> Levels do not apply to plants producing special cement or white cement clinker that require significantly higher process temperatures due to product specifications.</p> <p><sup>(2)</sup> Under normal (excluding, e.g. start-ups and shutdowns) and optimised operational conditions.</p> <p><sup>(3)</sup> The production capacity has an influence on the energy demand, with higher capacities providing energy savings and smaller capacities requiring more energy. Energy consumption also depends on the number of cyclone preheater stages, with more cyclone preheater stages leading to lower energy consumption of the kiln process. The appropriate number of cyclone preheater stages is mainly determined by the moisture content of raw materials.</p>		

### 4.2.3.2 Energy consumption

#### 7. In order to reduce/minimise thermal energy consumption, BAT is to use a combination of the following techniques:

	Technique	Applicability
a	Applying improved and optimised kiln systems and a smooth and stable kiln process, operating close to the process parameter set points by applying: <ol style="list-style-type: none"> <li>I. process control optimisation, including computer-based automatic control systems</li> <li>II. modern, gravimetric solid fuel feed systems</li> <li>III. preheating and precalcination to the extent possible, considering the existing kiln system configuration</li> </ol>	Generally applicable. For existing kilns, the applicability of preheating and precalcination is subject to the kiln system configuration
b	Recovering excess heat from kilns, especially from their cooling zone. In particular, the kiln excess heat from the cooling zone (hot air) or from the preheater can be used for drying raw materials	Generally applicable in the cement industry. Recovery of excess heat from the cooling zone is applicable when grate coolers are used. Limited recovery efficiency can be achieved on rotary coolers
c	Applying the appropriate number of cyclone stages related to the characteristics and properties of raw material and fuels used	Cyclone preheater stages are applicable to new plants and major upgrades.
d	Using fuels with characteristics which have a positive influence on the thermal energy consumption	The technique is generally applicable to the cement kilns subject to fuel availability and for existing kilns subject to the technical possibilities of injecting the fuel into the kiln
e	When replacing conventional fuels by waste fuels, using optimised and suitable cement kiln systems for burning wastes	Generally applicable to all cement kiln types
f	Minimising bypass flows	Generally applicable to the cement industry

#### Description

Several factors affect the energy consumption of modern kiln systems such as raw materials properties (e.g. moisture content, burnability), the use of fuels with different properties as well as the use of a gas bypass system. Furthermore, the production capacity of the kiln has an influence on the energy demand.

Technique 7c: the appropriate number of cyclone stages for preheating is determined by the throughput and the moisture content of raw materials and fuels which have to be dried by the remaining flue-gas heat because local raw materials vary widely regarding moisture content or burnability

Technique 7d: conventional and waste fuels can be used in the cement industry. The characteristics of the fuels used such as adequate calorific value and low moisture content have a positive influence on the specific energy consumption of the kiln.

Technique 7f: the removal of hot raw material and hot gas leads to a higher specific energy consumption of about 6 – 12 MJ/tonne clinker per percentage point of removed kiln inlet gas. Hence, minimising the use of gas bypass has a positive effect on energy consumption.

- 8. In order to reduce primary energy consumption, BAT is to consider the reduction of the clinker content of cement and cement products.**

**Description**

The reduction of the clinker content of cement and cement products can be achieved by adding fillers and/or additions, such as blast furnace slag, limestone, fly ash and pozzolana in the grinding step in accordance with the relevant cement standards.

**Applicability**

Generally applicable to the cement industry, subject to (local) availability of fillers and/or additions and local market specificities.

- 9. In order to reduce primary energy consumption, BAT is to consider cogeneration/combined heat and power plants.**

**Description**

The employment of cogeneration plants for the production of steam and electricity or of combined heat and power plants can be applied in the cement industry by recovering waste heat from the clinker cooler or kiln flue-gases using the conventional steam cycle processes or other techniques. Furthermore, excess heat can be recovered from the clinker cooler or kiln flue-gases for district heating or industrial applications.

**Applicability**

The technique is applicable in all cement kilns if sufficient excess heat is available, if appropriate process parameters can be met, and if economic viability is ensured.

- 10. In order to reduce/minimise electrical energy consumption, BAT is to use one or a combination of the following techniques:**

	<b>Technique</b>
a	Using power management systems
b	Using grinding equipment and other electricity based equipment with high energy efficiency
c	Using improved monitoring systems
d	Reducing air leaks into the system
e	Process control optimisation

**4.2.4 Use of waste**

**4.2.4.1 Waste quality control**

- 11. In order to guarantee the characteristics of the wastes to be used as fuels and/or raw materials in a cement kiln and reduce emissions, BAT is to apply the following techniques:**

	<b>Technique</b>
a	Apply quality assurance systems to guarantee the characteristics of wastes and to analyse any waste that is to be used as raw material and/or fuel in a cement kiln for: <ul style="list-style-type: none"> <li>I. constant quality</li> <li>II. physical criteria, e.g. emissions formation, coarseness, reactivity, burnability, calorific value</li> <li>III. chemical criteria, e.g. chlorine, sulphur, alkali and phosphate content and relevant metals content</li> </ul>
b	Control the amount of relevant parameters for any waste that is to be used as raw material and/or fuel in a cement kiln, such as chlorine, relevant metals (e.g. cadmium, mercury, thallium), sulphur, total halogen content
c	Apply quality assurance systems for each waste load

**Description**

Different types of waste materials can replace primary raw materials and/or fossil fuels in cement manufacturing and will contribute to saving natural resources.

**4.2.4.2 Waste feeding into the kiln**

- 12. In order to ensure appropriate treatment of the wastes used as fuel and/or raw materials in the kiln, BAT is to use the following techniques:**

	<b>Technique</b>
a	Use appropriate points to feed the waste into the kiln in terms of temperature and residence time depending on kiln design and kiln operation
b	To feed waste materials containing organic components that can be volatilised before the calcining zone into the adequately high temperature zones of the kiln system
c	To operate in such a way that the gas resulting from the co-incineration of waste is raised in a controlled and homogeneous fashion, even under the most unfavourable conditions, to a temperature of 850 °C for 2 seconds
d	To raise the temperature to 1100 °C, if hazardous waste with a content of more than 1 % of halogenated organic substances, expressed as chlorine, are co-incinerated
e	To feed wastes continuously and constantly
f	Delay or stop co-incinerating waste for operations such as start-ups and/or shutdowns when appropriate temperatures and residence times cannot be reached, as noted in a) to d) above

**4.2.4.3 Safety management for the use of hazardous waste materials**

- 13. BAT is to apply safety management for the storage, handling and feeding of hazardous waste materials, such as using a risk-based approach according to the source and type of waste, for the labelling, checking, sampling and testing of waste to be handled.**

## 4.2.5 Dust emissions

### 4.2.5.1 Diffuse dust emissions

14. In order to minimise/prevent diffuse dust emissions from dusty operations, BAT is to use one or a combination of the following techniques:

	Technique	Applicability
a	Use a simple and linear site layout of the installation	Applicable to new plants only
b	Enclose/encapsulate dusty operations, such as grinding, screening and mixing	Generally applicable
c	Cover conveyors and elevators, which are constructed as closed systems, if diffuse dust emissions are likely to be released from dusty material	
d	Reduce air leakages and spillage points	
e	Use automatic devices and control systems	
f	Ensure trouble-free operations	
g	<p>Ensure proper and complete maintenance of the installation using mobile and stationary vacuum cleaning.</p> <p>a) During maintenance operations or in cases of trouble with conveying systems, spillage of materials can take place. To prevent the formation of diffuse dust during removal operations, vacuum systems should be used. New buildings can easily be equipped with stationary vacuum cleaning piping, while existing buildings are normally better fitted with mobile systems and flexible connections</p> <ul style="list-style-type: none"> <li>In specific cases, a circulation process could be favoured for pneumatic conveying systems</li> </ul>	
h	<p>Ventilate and collect dust in fabric filters:</p> <ul style="list-style-type: none"> <li>As far as possible, all material handling should be conducted in closed systems maintained under negative pressure. The suction air for this purpose is then dedusted by a fabric filter before being emitted into the air</li> </ul>	
i	<p>Use closed storage with an automatic handling system:</p> <ul style="list-style-type: none"> <li>Clinker silos and closed fully automated raw material storage areas are considered the most efficient solution to the problem of diffuse dust generated by high volume stocks. These types of storage are equipped with one or more fabric filters to prevent diffuse dust formation in loading and unloading operations</li> <li>Use storage silos with adequate capacities, level indicators with cut out switches and with filters to deal with dust-bearing air displaced during filling operations</li> </ul>	
j	Use flexible filling pipes for dispatch and loading processes, equipped with a dust extraction system for loading cement, which are positioned towards the loading floor of the lorry	



**15. In order to minimise/prevent diffuse dust emissions from bulk storage areas, BAT is to use one or a combination of the following techniques:**

	<b>Technique</b>
a	Cover bulk storage areas or stockpiles or enclose them with screening, walling or an enclosure consisting of vertical greenery (artificial or natural wind barriers for open pile wind protection)
b	Use open pile wind protection: <ul style="list-style-type: none"> <li>• Outdoor storage piles of dusty materials should be avoided, but when they do exist it is possible to reduce diffuse dust by using properly designed wind barriers</li> </ul>
c	Use water spray and chemical dust suppressors: <ul style="list-style-type: none"> <li>• When the point source of diffuse dust is well localised, a water spray injection system can be installed. The humidification of dust particles aids agglomeration and so helps dust settle. A wide variety of agents is also available to improve the overall efficiency of the water spray</li> </ul>
d	Ensure paving, road wetting and housekeeping: <ul style="list-style-type: none"> <li>• Areas used by lorries should be paved when possible and the surface should be kept as clean as possible. Wetting the roads can reduce diffuse dust emissions, especially during dry weather. They also can be cleaned with road sweepers. Good housekeeping practices should be used in order to keep diffuse dust emissions to a minimum</li> </ul>
e	Ensure humidification of stockpiles: <ul style="list-style-type: none"> <li>• Diffuse dust emissions at stockpiles can be reduced by using sufficient humidification of the charging and discharging points, and by using conveyor belts with adjustable heights</li> </ul>
f	Match the discharge height to the varying height of the heap, automatically if possible or by reduction of the unloading velocity, when diffuse dust emissions at the charging or discharging points of storage sites cannot be avoided

**4.2.5.2 Channelled dust emissions from dusty operations**

This section refers to dust emissions arising from dusty operations other than those from kiln firing, cooling and the main milling processes. This covers processes such as the crushing of raw materials; raw material conveyors and elevators; the storage of raw materials, clinker and cement; the storage of fuels and the dispatch of cement.

**16. In order to reduce channelled dust emissions, BAT is to apply a maintenance management system which especially addresses the performance of filters applied to dusty operations, other than those from kiln firing, cooling and main milling processes. Taking this management system into account, BAT is to use dry flue-gas cleaning with a filter.**

**Description**

For dusty operations, dry flue-gas cleaning with a filter usually consists of a fabric filter. A description of fabric filters is provided in Section 4.5.1.

**BAT-associated emission levels**

The BAT-AEL for channelled dust emissions from dusty operations (other than those from kiln firing, cooling and the main milling processes) is  $<10 \text{ mg/Nm}^3$ , as the average over the sampling period (spot measurement, for at least half an hour).

It should be noted that for small sources ( $<10\,000 \text{ Nm}^3/\text{h}$ ) a priority approach, based on the maintenance management system, regarding the frequency for checking the performance of the filter has to be taken into account (see also BAT 5).

#### 4.2.5.3 Dust emissions from kiln firing processes

17. In order to reduce dust emissions from flue-gases of kiln firing processes, BAT is to use dry flue-gas cleaning with a filter.

Technique <sup>(1)</sup>	Applicability
a. Electrostatic precipitators (ESPs)	Applicable to all kiln systems
b. Fabric filters	
c. Hybrid filters	
<sup>(1)</sup> A description of the techniques is given in Section 4.5.1.	

#### BAT-associated emission levels

The BAT-AEL for dust emissions from flue-gases of kiln firing processes is <10 – 20 mg/Nm<sup>3</sup>, as the daily average value. When applying fabric filters or new or upgraded ESPs, the lower level is achieved.

#### 4.2.5.4 Dust emissions from cooling and milling processes

18. In order to reduce dust emissions from the flue-gases of cooling and milling processes, BAT is to use dry flue-gas cleaning with a filter.

Technique <sup>(1)</sup>	Applicability
a. Electrostatic precipitators (ESPs)	Generally applicable to clinker coolers and cement mills.
b. Fabric filters	Generally applicable to clinker coolers and mills
c. Hybrid filters	Applicable to clinker coolers and cement mills.
<sup>(1)</sup> A description of the techniques is given in Section 4.5.1.	

#### BAT-associated emission levels

The BAT-AEL for dust emissions from the flue-gases of cooling and milling processes is <10 – 20 mg/Nm<sup>3</sup>, as the daily average value or average over the sampling period (spot measurements for at least half an hour). When applying fabric filters or new or upgraded ESPs, the lower level is achieved.

## 4.2.6 Gaseous compounds

### 4.2.6.1 NO<sub>x</sub> emissions

19. In order to reduce the emissions of NO<sub>x</sub> from the flue-gases of kiln firing and/or preheating/precalcining processes, BAT is to use one or a combination of the following techniques:

	Technique <sup>(1)</sup>	Applicability
a	Primary techniques	
	I. Flame cooling	Applicable to all types of kilns used for cement manufacturing. The degree of applicability can be limited by product quality requirements and potential impacts on process stability
	II. Low NO <sub>x</sub> burners	Applicable to all rotary kilns, in the main kiln as well as in the precalciner
	III. Mid-kiln firing	Generally applicable to long rotary kilns
	IV. Addition of mineralisers to improve the burnability of the raw meal (mineralised clinker)	Generally applicable to rotary kilns subject to final product quality requirements
	V. Process optimisation	Generally applicable to all kilns
b	Staged combustion (conventional or waste fuels), also in combination with a precalciner and the use of optimised fuel mix	In general, can only be applied in kilns equipped with a precalciner. Substantial plant modifications are necessary in cyclone preheater systems without a precalciner.
		In kilns without precalciner, lump fuels firing might have a positive effect on NO <sub>x</sub> reduction depending on the ability to produce a controlled reduction atmosphere and to control the related CO emissions
c	Selective non-catalytic reduction (SNCR)	In principle, applicable to rotary cement kilns. The injection zones vary with the type of kiln process. In long wet and long dry process kilns it may be difficult to obtain the right temperature and retention time needed. See also BAT 20
d	Selective catalytic reduction (SCR)	Applicability is subject to appropriate catalyst and process development in the cement industry
<sup>(1)</sup> A description of the techniques is provided in Section 4.5.2		

### BAT-associated emission levels

See Table 4.2.

**Table 4.2: BAT-associated emission levels for NO<sub>x</sub> from the flue-gases of kiln firing and/or preheating/precalcining processes in the cement industry**

Kiln type	Unit	BAT-AEL (daily average value)
Preheater kilns	mg/Nm <sup>3</sup>	<200 – 450 <sup>(1)</sup> <sup>(2)</sup>
Lepol and long rotary kilns	mg/Nm <sup>3</sup>	400 – 800 <sup>(3)</sup>
<sup>(1)</sup> The upper level of the BAT-AEL range is 500 mg/Nm <sup>3</sup> , if the initial NO <sub>x</sub> level after primary techniques is >1000 mg/Nm <sup>3</sup> . <sup>(2)</sup> Existing kiln system design, fuel mix properties including waste and raw material burnability (e.g. special cement or white cement clinker) can influence the ability to be within the range. Levels below 350 mg/Nm <sup>3</sup> are achieved at kilns with favourable conditions when using SNCR. In 2008, the lower value of 200 mg/Nm <sup>3</sup> has been reported as a monthly average for three plants (easy burning mix used) using SNCR. <sup>(3)</sup> Depending on initial levels and NH <sub>3</sub> slip.		

20. When SNCR is used, BAT is to achieve efficient NO<sub>x</sub> reduction, while keeping the ammonia slip as low as possible, by using the following technique:

	Technique
a	To apply an appropriate and sufficient NO <sub>x</sub> reduction efficiency along with a stable operating process
b	To apply a good stoichiometric distribution of ammonia in order to achieve the highest efficiency of NO <sub>x</sub> reduction and to reduce the NH <sub>3</sub> slip
c	To keep the emissions of NH <sub>3</sub> slip (due to unreacted ammonia) from the flue-gases as low as possible taking into account the correlation between the NO <sub>x</sub> abatement efficiency and the NH <sub>3</sub> slip

#### Applicability

SNCR is generally applicable to rotary cement kilns. The injection zones vary with the type of kiln process. In long wet and long dry process kilns it may be difficult to obtain the right temperature and retention time needed. See also BAT 19.

#### BAT-associated emission levels

See Table 4.3.

Table 4.3: BAT-associated emission levels for NH<sub>3</sub> slip from the flue-gases

Parameter	Unit	BAT-AEL (daily average value)
NH <sub>3</sub> slip	mg/Nm <sup>3</sup>	<30 – 50 <sup>(1)</sup>
<sup>(1)</sup> The ammonia slip depends on the initial NO <sub>x</sub> level and on the NO <sub>x</sub> abatement efficiency. For Lepol and long rotary kilns, the level may be even higher.		

#### 4.2.6.2 SO<sub>x</sub> emissions

21. In order to reduce/minimise the emissions of SO<sub>x</sub> from the flue-gases of kiln firing and/or preheating/precalcining processes, BAT is to use one of the following techniques:

	Technique <sup>(1)</sup>	Applicability
a	Absorbent addition	Absorbent addition is, in principle, applicable to all kiln systems, although it is mostly used in suspension preheaters. Lime addition to the kiln feed reduces the quality of the granules/nodules and causes flow problems in Lepol kilns. For preheater kilns it has been found that direct injection of slaked lime into the flue-gas is less efficient than adding slaked lime to the kiln feed
b	Wet scrubber	Applicable to all cement kiln types with appropriate (sufficient) SO <sub>2</sub> levels for manufacturing the gypsum
<sup>(1)</sup> A description of the techniques is provided in Section 4.5.3		

#### Description

Depending on the raw materials and the fuel quality, levels of SO<sub>x</sub> emissions can be kept low not requiring the use of an abatement technique.

If necessary, primary techniques and/or abatement techniques such as absorbent addition or wet scrubber can be used to reduce SO<sub>x</sub> emissions.

Wet scrubbers have already been operated in plants with initial unabated SO<sub>x</sub> levels higher than 800 – 1000 mg/Nm<sup>3</sup>.

#### BAT-associated emission levels

See Table 4.4.

**Table 4.4: BAT-associated emission levels for SO<sub>x</sub> from the flue-gases of kiln firing and/or preheating/precalcining processes in the cement industry**

Parameter	Unit	BAT-AEL <sup>(1)</sup> <sup>(2)</sup> (daily average value)
SO <sub>x</sub> expressed as SO <sub>2</sub>	mg/Nm <sup>3</sup>	<50 – 400
<sup>(1)</sup> The range takes into account the sulphur content in the raw materials.		
<sup>(2)</sup> For white cement and special cement clinker production, the ability of clinker to retain fuel sulphur might be significantly lower leading to higher SO <sub>x</sub> emissions.		

#### 22. In order to reduce SO<sub>2</sub> emissions from the kiln, BAT is to optimise the raw milling processes.

##### Description

The technique consists of optimising the raw milling process so that the raw mill can be operated to act as SO<sub>2</sub> abatement for the kiln. This can be achieved by adjusting factors such as:

- b) raw material moisture
- c) mill temperature
- d) retention time in the mill
- e) fineness of the ground material.

##### Applicability

Applicable if the dry milling process is used in compound mode.

#### 4.2.6.3 CO emissions and CO trips

##### 4.2.6.3.1 Reduction of CO trips

#### 23. In order to minimise the frequency of CO trips and keep their total duration to below 30 minutes annually, when using electrostatic precipitators (ESPs) or hybrid filters, BAT is to use the following techniques in combination:

	Technique
a	Manage CO trips in order to reduce the ESP downtime
b	Continuous automatic CO measurements by means of monitoring equipment with a short response time and situated close to the CO source

##### Description

For safety reasons, due to the risk of explosions, ESPs will have to shut down during elevated CO levels in the flue-gases. The following techniques prevent CO trips and, therefore, reduce ESP shutdown times:

- control of the combustion process
- control of the organic load of raw materials
- control of the quality of the fuels and fuel feeding system

Disruptions predominantly happen during the start-up operation phase. For safe operation, the gas analysers for ESP protection have to be on-line during all operational phases and the ESP downtime can be reduced by using a backup monitoring system maintained in operation.

The continuous CO monitoring system needs to be optimised for reaction time and should be located close to the CO source, e.g. at a preheater tower outlet, or at a kiln inlet in the case of a wet kiln application.

When hybrid filters are used, the grounding of the bag support cage with the cell plate is recommended.

#### **4.2.6.4 Total organic carbon emissions (TOC)**

**24. In order to keep the emissions of TOC from the flue-gases of the kiln firing processes low, BAT is to avoid feeding raw materials with a high content of volatile organic compounds (VOC) into the kiln system via the raw material feeding route.**

#### **4.2.6.5 Hydrogen chloride (HCl) and hydrogen fluoride (HF) emissions**

**25. In order prevent/reduce the emissions of HCl from flue-gases of the kiln firing processes, BAT is to use one or a combination of the following primary techniques:**

	<b>Technique</b>
a	Using raw materials and fuels with a low chlorine content
b	Limiting the amount of chlorine content for any waste that is to be used as raw material and/or fuel in a cement kiln

#### **BAT-associated emission levels**

The BAT-AEL for the emissions of HCl is  $<10 \text{ mg/Nm}^3$ , as the daily average value or average over the sampling period (spot measurements, for at least half an hour).

**26. In order to prevent/reduce the emissions of HF from the flue-gases of the kiln firing processes, BAT is to use one or a combination of the following primary techniques:**

	<b>Technique</b>
a	Using raw materials and fuels with a low fluorine content
b	Limiting the amount of fluorine content for any waste that is to be used as raw material and/or fuel in a cement kiln

#### **BAT-associated emission levels**

The BAT-AEL for the emissions of HF is  $<1 \text{ mg/Nm}^3$ , as the daily average value or average over the sampling period (spot measurements, for at least half an hour).

#### 4.2.7 PCDD/F emissions

27. In order to prevent emissions of PCDD/F or to keep the emissions of PCDD/F from the flue-gases of the kiln firing processes low, BAT is to use one or a combination of the following techniques:

	Technique	Applicability
a	Carefully selecting and controlling of kiln inputs (raw materials), i.e. chlorine, copper and volatile organic compounds	Generally applicable
b	Carefully selecting and controlling kiln inputs (fuels), i.e. chlorine and copper	Generally applicable
c	Limiting/avoiding the use of wastes which contain chlorinated organic materials	Generally applicable
d	Avoid feeding fuels with a high content of halogens (e.g. chlorine) in secondary firing	Generally applicable
e	Quick cooling of kiln flue-gases to lower than 200 °C and minimising residence time of flue-gases and oxygen content in zones where the temperatures range between 300 and 450 °C	Applicable to long wet kilns and long dry kilns without preheating. In modern preheater and precalciner kilns, this feature is already inherent
f	Stop co-incinerating waste for operations such as start-ups and/or shutdowns	Generally applicable

##### BAT-associated emission levels

The BAT-AEL for the emissions of PCDD/F from the flue-gases of the kiln firing processes is <0.05 – 0.1 ng PCDD/F I-TEQ/Nm<sup>3</sup>, as the average over the sampling period (6 – 8 hours).

#### 4.2.7.1 Metal emissions

28. In order to minimise the emissions of metals from the flue-gases of the kiln firing processes, BAT is to use one or a combination of the following techniques:

	Technique
a	Selecting materials with a low content of relevant metals and limiting the content of relevant metals in materials, especially mercury
b	Using a quality assurance system to guarantee the characteristics of the waste materials used
c	Using effective dust removal techniques as set out in BAT 17

##### BAT-associated emission levels

See Table 4.5

**Table 4.5: BAT-associated emission levels for metals from the flue-gases of kiln firing processes**

Metals	Unit	BAT-AEL (average over the sampling period (spot measurements, for at least half an hour))
Hg	mg/Nm <sup>3</sup>	<0.05 <sup>(2)</sup>
∑ (Cd, Tl)	mg/Nm <sup>3</sup>	<0.05 <sup>(1)</sup>
∑ (As, Sb, Pb, Cr, Co, Cu, Mn, Ni, V)	mg/Nm <sup>3</sup>	<0.5 <sup>(1)</sup>

<sup>(1)</sup> Low levels have been reported based on the quality of the raw materials and the fuels.  
<sup>(2)</sup> Low levels have been reported based on the quality of the raw materials and the fuels. Values higher than 0.03 mg/Nm<sup>3</sup> have to be further investigated. Values close to 0.05 mg/Nm<sup>3</sup> require consideration of additional techniques (e.g. lowering of the flue-gas temperature, activated carbon).

#### 4.2.8 Process losses/waste

29. In order to reduce solid waste from the cement manufacturing process along with raw material savings, BAT is to:

	Technique	Applicability
a	Reuse collected dusts in the process, wherever practicable	Generally applicable but subject to dust chemical composition
b	Utilise these dusts in other commercial products, when possible	The utilisation of the dusts in other commercial products may not be within the control of the operator

#### Description

Collected dust can be recycled back into the production processes whenever practicable. This recycling may take place directly into the kiln or kiln feed (the alkali metal content being the limiting factor) or by blending with finished cement products. A quality assurance procedure might be required when the collected dusts are recycled back into the production processes. Alternative uses may be found for material that cannot be recycled (e.g. additive for flue-gas desulphurisation in combustion plants)



### 4.3 BAT conclusions for the lime industry

Unless otherwise stated, the BAT conclusions presented in this section can be applied to all installations in the lime industry.

#### 4.3.1 General primary techniques

- 30. In order to reduce all kiln emissions and use energy efficiently, BAT is to achieve a smooth and stable kiln process, operating close to the process parameter set points by using the following techniques:**

	Technique
a	Process control optimisation, including computer-based automatic control
b	Using modern, gravimetric solid fuel feed systems and/or gas flow meters

#### Applicability

Process control optimisation is applicable to all lime plants to varying degrees. Complete process automation is generally not achievable due to the uncontrollable variables, i.e. quality of the limestone.

- 31. In order to prevent and/or reduce emissions, BAT is to carry out a careful selection and control of the raw materials entering the kiln.**

#### Description

Raw materials entering the kiln have a significant effect on air emissions due to their impurities content; hence, a careful selection of raw materials may reduce these emissions at source. For example, the variations of sulphur and chlorine contents in the limestone/dolomite have an effect on the range of the SO<sub>2</sub> and HCl emissions in the flue-gas, while the presence of organic matter has an influence on TOC and CO emissions.

#### Applicability

The applicability depends on the (local) availability of raw materials with low impurities content. The type of final product and the type of kiln used may represent an additional constraint.

### 4.3.2 Monitoring

32. BAT is to carry out monitoring and measurements of process parameters and emissions on a regular basis including the following:

	Technique	Applicability
a	Continuous measurements of process parameters demonstrating the process stability, such as temperature, O <sub>2</sub> content, pressure, flow rate and CO emissions	Applicable to kiln processes
b	Monitoring and stabilising of critical process parameters, e.g. fuel feed, regular dosage and excess oxygen	
c	Continuous or periodic measurements of dust, NO <sub>x</sub> , SO <sub>x</sub> , CO emissions and NH <sub>3</sub> emissions when SNCR is applied	Applicable to kiln processes
d	Continuous or periodic measurements of HCl and HF emissions in case wastes are co-incinerated	Applicable to kiln processes
e	Continuous or periodic measurements of TOC emissions or continuous measurements in case wastes are co-incinerated	Applicable to kiln processes
f	Periodic measurements of PCDD/F and metal emissions	Applicable to kiln processes
g	Continuous or periodic measurements of dust emissions	Applicable to non-kiln processes  For small sources (<10 000 Nm <sup>3</sup> /h) the frequency of the measurements should be based on a maintenance management system

#### Description

Continuous or periodic measurements mentioned in BAT 32(c) to 32(f) are performed on the basis of the emission source and the type of pollutant expected.

For discontinuous (periodic) measurements of dust, NO<sub>x</sub>, SO<sub>x</sub> and CO emissions, a frequency of once a month and up to once a year at the time of normal operating conditions is given as an indication.

For discontinuous (periodic) measurements of PCDD/F, TOC, HCl, HF, metal emissions, a frequency appropriate to the raw materials and fuels that are used in the process should be applied.

### 4.3.3 Energy consumption

33. In order to reduce/minimise thermal energy consumption, BAT is to use a combination of the following techniques:

	Technique	Description	Applicability
a	<p>Applying improved and optimised kiln systems and a smooth and stable kiln process, operating close to the process parameter set points, through:</p> <ul style="list-style-type: none"> <li>I. process control optimisation</li> <li>II. heat recovery from flue-gases (e.g. use of surplus heat from rotary kilns to dry limestone for other processes such as limestone milling)</li> <li>III. modern, gravimetric solid fuel feed systems</li> <li>IV. maintenance of the equipment (e.g. air tightness, erosion of refractory)</li> <li>V. the use of optimised grain size of stone</li> </ul>	<p>Maintaining kiln control parameters close to their optimum values has the effect of reducing all consumption parameters due to, among other things, reduced numbers of shutdowns and upset conditions.</p> <p>The use of optimised grain size of stone is subject to raw material availability</p>	Technique (a) II is applicable only to long rotary kilns (LRK)
b	Using fuels with characteristics which have a positive influence on thermal energy consumption.	The characteristics of fuels, e.g. high calorific value and low moisture content can have a positive effect on the thermal energy consumption	The applicability depends on the technical possibility to feed the selected fuel into the kiln and on the availability of suitable fuels (e.g. high calorific value and low humidity) which may be impacted by the energy policy of the Member State
c	Limiting excess air	<p>A decrease of excess air used for combustion has a direct effect on fuel consumption since high percentages of air require more thermal energy to heat up the excess volume.</p> <p>Only in LRK and PRK the limitation of excess air has an impact on thermal energy consumption.</p> <p>The technique has a potential of increasing TOC and CO emission</p>	Applicable to LRK and PRK within the limits of a potential overheating of some areas in the kiln with consequent deterioration of the refractory lifetime

#### BAT-associated consumption levels

See Table 4.6.

**Table 4.6: BAT-associated levels for thermal energy consumption in the lime and dolime industry**

Kiln type	Thermal energy consumption <sup>(1)</sup> GJ/tonne of product
Long rotary kilns (LRK)	6.0 – 9.2
Rotary kilns with preheater (PRK)	5.1 – 7.8
Parallel flow regenerative kilns (PFRK)	3.2 – 4.2
Annular shaft kilns (ASK)	3.3 – 4.9
Mixed feed shaft kilns (MFSK)	3.4 – 4.7
Other kilns (OK)	3.5 – 7.0
<sup>(1)</sup> Energy consumption depends on the type of product, the product quality, the process conditions and the raw materials	

**34. In order to minimise electrical energy consumption, BAT is to use one or a combination of the following techniques:**

	Technique
a	Using power management systems
b	Using optimised grain size of limestone
c	Using grinding equipment and other electricity based equipment with high energy efficiency

#### Description – Technique (b)

Vertical kilns can usually burn only coarse limestone pebbles. However, rotary kilns with higher energy consumption can also valorise small fractions and new vertical kilns can burn small granules from 10 mm. The larger granules of kiln feed stone are used more in vertical kilns than in rotary kilns.

#### 4.3.4 Consumption of limestone

**35. In order to minimise limestone consumption, BAT is to use one or a combination of the following techniques:**

	Technique	Applicability
a	Specific quarrying, crushing and well directed use of limestone (quality, grain size)	Generally applicable in the lime industry; however, stone processing is dependent on the limestone quality
b	Selecting kilns applying optimised techniques which allow for operating with a wider range of limestone grain sizes to make optimum use of quarried limestone	Applicable to new plants and major upgrades of kiln.  Vertical kilns can in principle only burn coarse limestone pebbles. Fine lime PFRK and/or rotary kilns can operate with smaller limestone grain sizes

#### 4.3.5 Selection of fuels

**36. In order to prevent/reduce emissions, BAT is to carry out a careful selection and control of fuels entering the kiln.**

#### Description

Fuels entering the kiln may have a significant effect on air emissions due to their impurities content. The content of sulphur (for long rotary kilns in particular), nitrogen and chlorine have an effect on the range of the SO<sub>x</sub>, NO<sub>x</sub> and HCl emissions in the flue-gas. Depending on the

chemical composition of the fuel and the type of kiln used, the choice of appropriate fuels or a fuel mix can lead to emissions reductions.

### Applicability

Except for mixed feed shaft kilns, all types of kilns can operate with all types of fuels and fuel mixtures subject to fuels availability which may be impacted by the energy policy of the Member State. The selection of fuel also depends on the desired quality of the final product, the technical possibility to feed the fuel into the selected kiln, and economic considerations.

#### 4.3.5.1 Use of waste fuels

##### 4.3.5.1.1 Waste quality control

**37. In order to guarantee the characteristics of waste to be used as fuel in a lime kiln, BAT is to apply the following techniques:**

	Technique
a	Apply a quality assurance system to guarantee and control the characteristics of wastes and to analyse any waste that is to be used as fuel in the kiln for: <ul style="list-style-type: none"> <li>I. constant quality</li> <li>II. physical criteria, e.g. emissions formation, coarseness, reactivity, burnability, calorific value</li> <li>III. chemical criteria, e.g. total chlorine content, sulphur, alkali, and phosphate content and relevant metals content (e.g. total chromium, lead, cadmium, mercury, thallium)</li> </ul>
b	Control the amount of relevant components for any waste that is to be used as fuel, such as total halogen content, metals (e.g. total chromium, lead, cadmium, mercury, thallium) and sulphur

##### 4.3.5.1.2 Waste feeding into the kiln

**38. In order to prevent/reduce emissions occurring from the use of waste fuels into the kiln, BAT is to use the following techniques:**

	Technique
a	To use appropriate burners for feeding suitable wastes depending on kiln design and kiln operation
b	To operate in such a way that the gas resulting from the co-incineration of waste is raised in a controlled and homogeneous fashion and even under the most unfavourable conditions, to a temperature of 850 °C for 2 seconds
c	To raise the temperature to 1100 °C if hazardous wastes with a content of more than 1 % of halogenated organic substances, expressed as chlorine, are co-incinerated
d	To feed wastes continuously and constantly
e	To stop feeding waste for operations such as start-ups and/or shutdowns when appropriate temperatures and residence times cannot be reached, as mentioned in (b) and (c) above

### Safety management for the use of hazardous waste materials

**39. In order to prevent accidental emissions, BAT is to use safety management for the storage, handling and feeding into the kiln of hazardous waste materials.**

#### Description

The use of a safety management for the storage, handling and feeding of hazardous waste materials consists of a risk-based approach according to the source and type of waste, for the labelling, checking, sampling and testing of waste to be handled.

### 4.3.6 Dust emissions

#### 4.3.6.1 Diffuse dust emissions

40. In order to minimise/prevent diffuse dust emissions from dusty operations, BAT is to use one or a combination of the following techniques:

	Technique
a	Enclosure/encapsulation of dusty operations, such as grinding, screening and mixing
b	Use of covered conveyors and elevators, which are constructed as closed systems, if dust emissions are likely to be released from dusty material
c	Use of storage silos with adequate capacity, level indicators with cut out switches and with filters to deal with dust-bearing air displaced during filling operations
d	Use of a circulation process which is favoured for pneumatic conveying systems
e	Material handling in closed systems maintained under negative pressure and dedusting of the suction air by a fabric filter before being emitted into the air
f	Reduction of air leakage and spillage points, completion of installation
g	Proper and complete maintenance of the installation
h	Use of automatic devices and control systems
i	Use of continuous trouble-free operations
j	Use of flexible filling pipes equipped with a dust extraction system for loading line which are positioned at the loading floor of the lorry

#### Applicability

In raw material preparation operations, like crushing and sieving, dust separation is not normally needed, because of the moisture content of the raw material.

41. In order to minimise/prevent diffuse dust emissions from bulk storage areas, BAT is to use one or a combination of the following techniques:

	Technique
a	Enclose storage locations using screening, walling or vertical greenery (artificial or natural wind barriers for open pile wind protection)
b	Use product silos and closed, fully-automated raw material storages. These types of storage are equipped with one or more fabric filters to prevent diffuse dust formation in loading and unloading operations
c	Reduce diffuse dust emissions at stockpiles by using sufficient humidification of stockpile charging and discharging points and the use of conveyor belts with adjustable height. When using humidification or spraying measures/techniques, the ground can be sealed and the surplus water can be gathered, and if necessary this can be treated and used in closed cycles
d	Reduce diffuse dust emissions at charging or discharging points of storage sites if they cannot be avoided, by matching the discharge height to the varying height of the heap, if possible automatically, or by reduction of the unloading velocity
e	Keep the locations wet, especially dry areas, using spraying devices and clean them by cleaning lorries
f	Use vacuum systems during removal operations. New buildings can easily be equipped with stationary vacuum cleaning systems, while existing buildings are normally better fitted with mobile systems and flexible connections
g	Reduce diffuse dust emissions arising in areas used by lorries, by paving these areas when possible and keeping the surface as clean as possible. Wetting the roads can reduce diffuse dust emissions, especially during dry weather. Good housekeeping practices can be used in order to keep diffuse dust emissions to a minimum

#### 4.3.6.2 Channelled dust emissions from dusty operations other than those from kiln firing processes

42. In order to reduce channelled dust emissions from dusty operations other than those from kiln firing processes, BAT is to use one of the following techniques and to use a maintenance management system which specifically addresses the performance of filters:

Technique <sup>(1)</sup> <sup>(2)</sup>	Applicability
Fabric filter	Generally applicable to milling and grinding plants and subsidiary processes in the lime industry; hydration plants; material transport; and storage and loading facilities
Wet scrubbers	Mainly applicable to hydrating lime plants
<sup>(1)</sup> A description of the techniques is provided in Section 4.6.1	
<sup>(2)</sup> If necessary, centrifugal separators/cyclones can be used as pretreatment of the flue-gases.	

#### BAT-associated emission levels

See Table 4.7.

Table 4.7: BAT-associated emission levels for channelled dust emissions from dusty operations other than those from kiln firing processes

Technique	Unit	BAT-AEL (daily average or average over the sampling period (spot measurements for at least half an hour))
Fabric filter	mg/Nm <sup>3</sup>	<10
Wet scrubber	mg/Nm <sup>3</sup>	<10 – 20

It should be noted that for small sources (<10 000 Nm<sup>3</sup>/h) a priority approach regarding the frequency for checking the performance of the filter has to be taken into account (see BAT 32).

#### 4.3.6.3 Dust emissions from kiln firing processes

43. In order to reduce dust emissions from the flue-gases of kiln firing processes, BAT is to use flue-gas cleaning with a filter. One or a combination of the following techniques can be used:

Technique <sup>(1)</sup>	Applicability
ESP	Applicable to all kiln systems
Fabric filter	Applicable to all kiln systems
Wet dust separator	Applicable to all kiln systems
Centrifugal separator/cyclone	Centrifugal separators are only suitable as pre-separators and can be used to pre-clean the flue-gases from all kiln systems
<sup>(1)</sup> A description of the techniques is provided in Section 4.6.1	

#### BAT-associated emission levels

See Table 4.8.

**Table 4.8: BAT-associated emission levels for dust emissions from the flue-gases of kiln firing processes**

Technique	Unit	BAT-AEL (daily average value or average over the sampling period (spot measurements for at least half an hour))
Fabric filter	mg/Nm <sup>3</sup>	<10
ESP or other filters	mg/Nm <sup>3</sup>	<20*
(*) In exceptional cases where the resistivity of dust is high, the BAT-AEL could be higher, up to 30 mg/Nm <sup>3</sup> , as the daily average value.		

### 4.3.7 Gaseous compounds

#### 4.3.7.1 Primary techniques for reducing emissions of gaseous compounds

44. In order to reduce the emissions of gaseous compounds (i.e. NO<sub>x</sub>, SO<sub>x</sub>, HCl, CO, TOC/VOC, volatile metals) from the flue-gases of kiln firing processes, BAT is to use one or a combination of the following techniques:

	Technique	Applicability
a	Careful selection and control of substances entering the kiln	Generally applicable
b	Reducing the pollutant precursors in fuels and, if possible, in raw materials, i.e. <ol style="list-style-type: none"> <li>I. selecting fuels, where available, with low contents of sulphur (for long rotary kilns in particular), nitrogen and chlorine</li> <li>II. selecting raw materials, if possible, with low contents of organic matter</li> <li>III. selecting suitable waste fuels for the process and the burner</li> </ol>	Generally applicable in the lime industry subject to local availability of raw materials and fuels, the type of kiln used, the desired product qualities and the technical possibility of feeding the fuels into the selected kiln
c	Using process optimisation techniques to ensure an efficient absorption of sulphur dioxide (e.g. efficient contact between the kiln gases and the quicklime)	Applicable to all lime plants.  In general, complete process automation is not achievable due to uncontrollable variables, i.e. quality of the limestone



4.3.7.2 NO<sub>x</sub> emissions

45. In order to reduce the emissions of NO<sub>x</sub> from the flue-gases of kiln firing processes, BAT is to use one or a combination of the following techniques:

	Technique	Applicability
a	Primary techniques	
	I. Appropriate fuel selection along with limitation of nitrogen content in the fuel	Generally applicable in the lime industry subject to fuel availability which may be impacted by the energy policy of the Member State and to the technical possibility to feed a certain type of fuel into the selected kiln
	II. Process optimisation including flame shaping and temperature profile	Optimisation of process and process control can be applied in lime manufacturing but is subject to the final product quality
	III. Burner design (low NO <sub>x</sub> burner) <sup>(1)</sup>	Low NO <sub>x</sub> burners are applicable to rotary kilns and to annular shaft kilns presenting conditions of high primary air. PFRKs and other shaft kilns have flameless combustion, thus rendering low NO <sub>x</sub> burners not applicable to this kiln type
	IV. Air staging <sup>(1)</sup>	Not applicable to shaft kilns. Applicable only to PRK but not when hard burned lime is produced. The applicability may be limited by constraints imposed by the type of final product, due to possible overheating in some areas of the kiln and consequent deterioration of the refractory lining
b	SNCR <sup>(1)</sup>	Applicable to Lepol rotary kilns. See also BAT 46

<sup>(1)</sup> A description of the techniques is provided in Section 4.6.2

#### BAT-associated emission levels

See Table 4.9.

**Table 4.9: BAT-associated emission levels for NO<sub>x</sub> from flue-gases of kiln firing processes in the lime industry**

Kiln type	Unit	BAT-AEL (daily average value or average over the sampling period (spot measurements for at least half an hour), stated as NO <sub>2</sub> )
PFRK, ASK, MFSK, OSK	mg/Nm <sup>3</sup>	100 – 350 <sup>(1)</sup> <sup>(3)</sup>
LRK, PRK	mg/Nm <sup>3</sup>	<200 – 500 <sup>(1)</sup> <sup>(2)</sup>

<sup>(1)</sup> The higher ends of the ranges are related to the production of dolime and hard burned lime. Higher levels than the upper end of the range may be associated with the production of sintered dolime.  
<sup>(2)</sup> For LRK and PRK with shaft producing hard burned lime, the upper level is up to 800 mg/Nm<sup>3</sup>  
<sup>(3)</sup> Where primary techniques as indicated in BAT 45 (a)I are not sufficient to reach this level and where secondary techniques are not applicable to reduce the NO<sub>x</sub> emissions to 350 mg/Nm<sup>3</sup>, the upper level is 500 mg/Nm<sup>3</sup>, especially for hard burned lime and for the use of biomass as fuel.

46. When SNCR is used, BAT is to achieve efficient NO<sub>x</sub> reduction, while keeping the ammonia slip as low as possible, by using the following technique:

	Technique
a	To apply an appropriate and sufficient reduction efficiency along with a stable operating process
b	To apply a good stoichiometric ratio and distribution of ammonia in order to achieve the highest efficiency of NO <sub>x</sub> reduction and to reduce the ammonia slip
c	To keep the emissions of NH <sub>3</sub> slip (due to unreacted ammonia) from the flue-gases as low as possible, taking into account the correlation between the NO <sub>x</sub> abatement efficiency and the NH <sub>3</sub> slip.

#### Applicability

Applicable only to Lepol rotary kilns, where the ideal temperature range of 850 to 1020 °C is accessible. See also BAT 45, technique (b).

#### BAT-associated emission levels

The BAT-AEL for the emissions of NH<sub>3</sub> slip from the flue-gases is <30 mg/Nm<sup>3</sup>, as the daily average value or average over the sampling period (spot measurements for at least half an hour).

#### 4.3.7.3 SO<sub>x</sub> emissions

47. In order to reduce the emissions of SO<sub>x</sub> from the flue-gases of kiln firing processes, BAT is to use one or a combination of the following techniques:

	Technique	Applicability
a	Process optimisation to ensure an efficient absorption of sulphur dioxide (e.g. efficient contact between the kiln gases and the quicklime)	Process control optimisation is applicable to all lime plants
b	Selecting fuels with a low sulphur content	Generally applicable, subject to fuel availability in particular for use in long rotary kilns (LRK), due to high SO <sub>x</sub> emissions
c	Using absorbent addition techniques (e.g. absorbent addition, dry flue-gas cleaning with a filter, wet scrubber, or activated carbon injection) <sup>(1)</sup>	Absorbent addition techniques are, in principle, applicable in the lime industry; however, this technique had not yet been applied in the lime sector in 2007. Particularly for rotary lime kilns further investigation is required in order to assess its applicability

<sup>(1)</sup> A description of the techniques is provided in Section 4.6.3

#### BAT-associated emission levels

See Table 4.10.

**Table 4.10: BAT-associated emission levels for SO<sub>x</sub> from flue-gases of kiln firing processes in the lime industry**

Kiln type	Unit	BAT-AEL <sup>(1)</sup> <sup>(2)</sup> (daily average value or average over the sampling period (spot measurements for at least half an hour), SO <sub>x</sub> expressed as SO <sub>2</sub> )
PFRK, ASK, MFSK, OSK, PRK	mg/Nm <sup>3</sup>	<50 – 200
LRK	mg/Nm <sup>3</sup>	<50 – 400

<sup>(1)</sup> The level depends on the initial SO<sub>x</sub> level in the flue-gas and on the reduction technique used.  
<sup>(2)</sup> For the production of sintered dolime using the 'double pass process', SO<sub>x</sub> emissions might be higher than the upper end of the range.

#### 4.3.7.4 CO emissions and CO trips

##### 4.3.7.4.1 CO emissions

48. In order to reduce the emissions of CO from the flue-gases of kiln firing processes, BAT is to use one or a combination of the following techniques:

	Technique	Applicability
a	Selecting, raw materials with a low content of organic matter	Generally applicable to the lime industry within the constraints of the local availability and composition of raw materials, the type of kiln used and the quality of the final product
b	Using process optimisation techniques to achieve a stable and complete combustion	Applicable to all lime plants. In general, complete process automation is not achievable due to uncontrollable variables, i.e. quality of the limestone

In this context, see also BAT 30 and 31 in Section 4.3.1 and BAT 32 in Section 4.3.2.

#### BAT-associated emission levels

See Table 4.11.

**Table 4.11: BAT-associated emission levels for CO from the flue-gas of kiln firing processes**

Kiln type	Unit	BAT-AEL <sup>(1)</sup> <sup>(2)</sup> (daily average value or average over the sampling period (spot measurements for at least half an hour))
PFRK, OSK, LRK, PRK	mg/Nm <sup>3</sup>	<500

<sup>(1)</sup> Emissions can be higher depending on raw materials used and/or type of lime produced, e.g. hydraulic lime.  
<sup>(2)</sup> BAT-AEL does not apply to MFSK and ASK.

##### 4.3.7.4.2 Reduction of CO trips

49. In order to minimise the frequency of CO trips when using electrostatic precipitators, BAT is to use the following techniques:

	Technique
a	Manage CO trips in order to reduce the ESP downtime
b	Continuous automatic CO measurements by means of monitoring equipment with a short response time and situated close to the CO source

**Description**

For safety reasons, due to the risk of explosions, ESPs will have to shut down during elevated CO levels in the flue-gases. The following techniques prevent CO trips and, therefore, reduce ESP shutdown times:

- control of the combustion process
- control of the organic load of raw materials
- control of the quality of the fuels and fuel feeding system

Disruptions predominantly happen during the start-up operation phase. For safe operation, the gas analysers for ESP protection have to be on-line during all operational phases and the ESP downtime can be reduced by using a backup monitoring system maintained in operation.

The continuous CO monitoring system needs to be optimised for reaction time and should be located close to the CO source, e.g. at a preheater tower outlet, or at a kiln inlet in the case of a wet kiln application.

**Applicability**

Generally applicable to rotary kilns fitted with electrostatic precipitators (ESPs).

**4.3.7.5 Total organic carbon emissions (TOC)**

**50. In order to reduce the emissions of TOC from the flue-gases of kiln firing processes, BAT is to use one or a combination of the following techniques:**

	<b>Technique</b>
a	Applying general primary techniques and monitoring (see also BAT 30 and 31 in Section 4.3.1, and BAT 32 in Section 4.3.2)
b	Avoid feeding raw materials with a high content of volatile organic compounds into the kiln system (except for hydraulic lime production)

**Applicability**

For applicability of general primary techniques and monitoring see BAT 30 and 31 in Section 4.3.1, and BAT 32 in Section 4.3.2.

Technique (b) is generally applicable to the lime industry, subject to local raw materials availability and/or the type of lime produced.

**BAT-associated emission levels**

See Table 4.12.

**Table 4.12: BAT-associated emission levels for TOC from the flue-gas of kiln firing processes**

<b>Kiln type</b>	<b>Unit</b>	<b>BAT-AEL (daily average value or average over the sampling period (spot measurements for at least half an hour))</b>
LRK <sup>(1)</sup> , PRK <sup>(1)</sup>	mg/Nm <sup>3</sup>	<10
ASK <sup>(1)</sup> , MFSK <sup>(1)</sup> <sup>(2)</sup> , PFRK <sup>(2)</sup>	mg/Nm <sup>3</sup>	<30
<sup>(1)</sup> Level can be higher depending on the content of organic matter of raw materials used and/or the type of lime produced, in particular for the production of natural hydraulic lime. <sup>(2)</sup> In exceptional cases, the level can be higher.		

#### 4.3.7.6 Hydrogen chloride (HCl) and hydrogen fluoride (HF) emissions

51. In order to reduce the emissions of HCl and the emissions of HF from the flue-gas of kiln firing processes, when using waste, BAT is to use the following primary techniques:

	Technique
a	Using conventional fuels with a low chlorine and fluorine content
b	Limiting the amount of chlorine and fluorine content for any waste that is to be used as fuel in a lime kiln

#### Applicability

The techniques are generally applicable in the lime industry but subject to local availability of suitable fuel.

#### BAT-associated emission levels

See Table 4.13.

Table 4.13: BAT-associated emission levels for HCl and HF emissions from the flue-gas of kiln firing processes, when using wastes

Emission	Unit	BAT-AEL (daily average value or the average value over the sampling period (spot measurements, for at least half an hour))
HCl	mg/Nm <sup>3</sup>	<10
HF	mg/Nm <sup>3</sup>	<1

#### 4.3.8 PCDD/F emissions

52. In order to prevent or reduce the emissions of PCDD/F from the flue-gas of kiln firing processes, BAT is to use one or a combination of the following primary techniques:

	Technique
a	Selecting fuels with a low chlorine content
b	Limiting the copper input through the fuel
c	Minimising the residence time of the flue-gases and the oxygen content in zones where the temperatures range between 300 and 450 °C

#### BAT-associated emission levels

The BAT-AELs are <0.05 – 0.1 ng PCDD/F I-TEQ/Nm<sup>3</sup>, as the average over the sampling period (6 – 8 hours).

### 4.3.9 Metal emissions

53. In order to minimise the emissions of metals from the flue-gases of kiln firing processes, BAT is to use one or a combination of the following techniques:

	Technique
a	Selecting fuels with a low content of metals
b	Using a quality assurance system to guarantee the characteristics of the waste fuels used
c	Limiting the content of relevant metals in materials, especially mercury
d	Using one or a combination of dust removal techniques as set out in BAT 43

#### BAT-associated emission levels

See Table 4.14.

Table 4.14: BAT associated emission levels for metals from the flue-gases of kiln firing processes, when using wastes

Metals	Unit	BAT-AEL (average over the sampling period (spot measurements for at least half an hour))
Hg	mg/Nm <sup>3</sup>	<0.05
∑ (Cd, Tl)	mg/Nm <sup>3</sup>	<0.05
∑ (As, Sb, Pb, Cr, Co, Cu, Mn, Ni, V)	mg/Nm <sup>3</sup>	<0.5

NB: Low levels were reported when applying techniques as mentioned in BAT 53 (a) – (d).

Furthermore in this context, see also BAT 37 (Section 4.3.5.1.1) and BAT 38 (Section 4.3.5.1.2).

### 4.3.10 Process losses/waste

54. In order to reduce the solid wastes from the lime manufacturing processes and to save raw materials, BAT is to use the following techniques:

	Technique	Applicability
a	Reuse the collected dust or other particulate matter (e.g. sand, gravel) in the process	Generally applicable whenever practicable
b	Utilise dust, off-specification quicklime and off-specification hydrated lime in selected commercial products	Generally utilised in different kinds of selected commercial products, whenever practicable

## 4.4 BAT conclusions for the magnesium oxide industry

Unless otherwise stated, the BAT conclusions presented in this section can be applied to all installations in the magnesium oxide industry (dry process route).

### 4.4.1 Monitoring

**55. BAT is to carry out monitoring and measurements of process parameters and emissions on a regular basis including the following:**

	Technique	Applicability
a	Continuous measurements of process parameters demonstrating the process stability, such as temperature, O <sub>2</sub> content, pressure, flow rate	Generally applicable to kiln processes
b	Monitoring and stabilising critical process parameters, i.e. raw material and fuel feed, regular dosage and excess oxygen	
c	Continuous or periodic measurements of dust, NO <sub>x</sub> , SO <sub>x</sub> and CO emissions	Generally applicable to kiln processes
d	Continuous or periodic measurements of dust emissions	Applicable to non-kiln processes. For small source (<10 000 Nm <sup>3</sup> /h) the frequency of the measurements or performance check should be based on a maintenance management system

#### Description

Continuous or periodic measurements mentioned in BAT 55 (c) are performed on the basis of the emission source and the type of pollutant expected.

For discontinuous (periodic) measurements for dust, NO<sub>x</sub>, SO<sub>x</sub> and CO emissions from kiln processes, a frequency of once a month and up to once a year and at the time of normal operating conditions is given as an indication.

## 4.4.2 Energy consumption

56. In order to reduce thermal energy consumption, BAT is to use a combination of the following techniques:

	Technique	Description	Applicability
a	Applying improved and optimised kiln systems and a smooth and stable kiln process by applying: I. process control optimisation II. heat recovery from flue-gases from kiln and coolers	Heat recovery from flue-gases by the preliminary heating of the magnesite can be used in order to reduce fuel energy use. Heat recovered from the kiln can be used for drying fuels, raw materials and some packaging materials	Process control optimisation is applicable to all kiln types used in the magnesia industry.
b	Using fuels with characteristics which have a positive influence on thermal energy consumption	The characteristics of fuels, e.g. high calorific value and low moisture content have a positive effect on the thermal energy consumption	Generally applicable subject to availability of the fuels, the type of kilns used, the desired product qualities and the technical possibilities of injecting the fuels into the kiln.
c	Limiting excess air	The excess oxygen level to obtain the required quality of the products and for optimal combustion is usually in practice about 1 – 3 %	Generally applicable

### BAT-associated consumption levels

The BAT-associated thermal energy consumption is 6 – 12 GJ/t, depending on the process and the products <sup>(1)</sup>.

<sup>(1)</sup> This range only reflects information provided for the magnesium oxide chapter of the BREF. More specific information about best performing techniques along with the products produced was not provided.

57. In order to minimise electrical energy consumption, BAT is to use one or a combination of the following techniques:

	Technique
a	Using power management systems
b	Using grinding equipment and other electricity based equipment with high energy efficiency



### 4.4.3 Dust emissions

#### 4.4.3.1 Diffuse dust emissions

58. In order to minimise/prevent diffuse dust emissions from dusty operations, BAT is to use one or a combination of the following techniques:

	Technique
a	Simple and linear site layout
b	Good housekeeping of buildings and roads, along with proper and complete maintenance of the installation
c	Watering of raw material piles
d	Enclosure/encapsulation of dusty operations, such as grinding and screening
e	Use of covered conveyors and elevators, which are constructed as closed systems, if dust emissions are likely to be released from dusty material
f	Use of storage silos with adequate capacities and equipping them with filters to deal with dust-bearing air displaced during filling operations
g	A circulation process is favoured for pneumatic conveying systems
h	Reduction of air leakage and spillage points
i	Use of automatic devices and control systems
k	Use of continuous trouble-free operations

#### 4.4.3.2 Channelled dust emissions from dusty operations other than kiln firing processes

59. In order to reduce channelled dust emissions from dusty operations other than those from kiln firing processes, BAT is to use flue-gas cleaning with a filter by applying one or a combination of the following techniques, and to use a maintenance management system which specifically addresses the performance of techniques:

	Technique <sup>(1)</sup>	Applicability
a	Fabric filters	Generally applicable to all units in the magnesium oxide manufacturing process, especially for dusty operations, screening, grinding and milling
b	Centrifugal separators/ cyclones	Because of the system-dependent limited degree of separation, cyclones are mainly applicable as preliminary separators for coarse dust and flue-gases
c	Wet dust separators	Generally applicable
<sup>(1)</sup> A description of the techniques is provided in Section 4.7.1		

#### BAT-associated emission levels

The BAT-AEL for channelled dust emissions from dusty operations other than those from kiln firing processes is <10 mg/Nm<sup>3</sup>, as daily average or average over the sampling period (spot measurements, for at least half an hour).

It should be noted that for small sources (<10 000 Nm<sup>3</sup>/h) a priority approach, based on a maintenance management system regarding the frequency for checking the performance of the filter has to be taken into account (see BAT 55).

#### 4.4.3.3 Dust emissions from the kiln firing process

60. In order to reduce dust emissions from the flue-gases of kiln firing processes, BAT is to use flue-gas cleaning with a filter by applying one or a combination of the following techniques:

	Technique <sup>(1)</sup>	Applicability
a	Electrostatic precipitators (ESPs)	ESPs are mainly applicable in rotary kilns. They are applicable for flue-gas temperatures above the dew point and up to 370 – 400 °C
b	Fabric filters	<p>Fabric filters for dust removal from flue-gases can, in principle, be applied for all units in the magnesium oxide manufacturing process. They can be used for flue-gas temperatures above the dew point and up to 280 °C.</p> <p>For the production of caustic calcined magnesia (CCM) and sintered/dead burned magnesia (DBM), due to the high temperatures, the corrosive nature and the high volume of the flue-gases occurring from the kiln firing process, special fabric filters with high temperature-resistant filter material have to be used. However, experience from the magnesia industry producing DBM shows that no suitable equipment is available for flue-gas temperatures of approximately 400 °C for magnesia production</p>
c	Centrifugal separators/ cyclones	Because of the system-dependent limited degree of separation, cyclones are mainly applicable as preliminary separators for coarse dust and flue-gases
d	Wet dust separators	Generally applicable

<sup>(1)</sup> A description of the techniques is provided in Section 4.7.1

#### BAT-associated emission levels

The BAT-AEL for dust emissions from the flue-gases of kiln firing processes is <20 – 35 mg/Nm<sup>3</sup> as the daily average value or average over the sampling period (spot measurements, for at least half an hour).

#### 4.4.4 Gaseous compounds

##### 4.4.4.1 General primary techniques for reducing emissions of gaseous compounds

61. In order to reduce the emissions of gaseous compounds (i.e. NO<sub>x</sub>, HCl, SO<sub>x</sub>, CO) from flue-gases of kiln firing processes, BAT is to use one or a combination of the following primary techniques:

	Technique	Applicability
a	Careful selection and control of the substances entering the kiln in order to reduce the pollutant precursors, i.e.: I. selecting fuels with low contents of sulphur, if available, chlorine and nitrogen II. selecting raw materials with low contents of organic matter III. selecting suitable waste fuels for the process and the burner	Generally applicable subject to availability of raw materials and fuels, the type of kiln used, the desired product qualities and the technical possibility of injecting the fuels into the selected kiln.  Waste materials can be considered as fuels in the magnesia industry but had not yet been applied in the magnesia industry in 2007
b	Using process optimisation measures/techniques to ensure a smooth and stable kiln process, operating close to the stoichiometric required air	Process control optimisation is applicable to all kiln types used in the magnesia industry. However, a highly sophisticated process control system may be necessary

##### 4.4.4.2 NO<sub>x</sub> emissions

62. In order to reduce the emissions of NO<sub>x</sub> from the flue-gases of kiln firing processes, BAT is to use a combination of the following techniques:

	Technique	Applicability
a	Appropriate fuel selection along with a limited nitrogen content in the fuel	Generally applicable subject to fuels availability
b	Process optimisation and improved firing technique	Generally applicable in the magnesia industry

##### BAT-associated emission levels

The BAT-AEL for the emissions of NO<sub>x</sub> from the flue-gases of kiln firing processes is <500 – 1500 mg/Nm<sup>3</sup>, as the daily average value or average over the sampling period (spot measurements for at least half an hour) stated as NO<sub>2</sub>. The higher values are related to the high temperature DBM process.

**4.4.4.3 CO emissions and CO trips****4.4.4.3.1 CO emissions**

**63. In order to reduce the emissions of CO from the flue-gases of kiln firing processes, BAT is to use a combination of the following techniques:**

	<b>Technique</b>	<b>Description</b>
a	Selecting raw materials with a low content of organic matter	A part of CO emissions results from the organic matter of raw materials thus selection of raw materials with low organic content can reduce CO emissions
b	Process control optimisation	A complete and correct combustion is essential to reduce CO emissions. Air supply from cooler and primary air as well as the draught of the stack fan can be controlled in order to keep an oxygen level of between 1 (sinter) and 1.5 % (caustic) during the combustion. A change of air and fuel charge can reduce CO emissions. Furthermore, CO emissions can be decreased by changing the depth of the burner
c	Feeding fuels controlled, constantly and continuously	Controlled fuel addition includes, e.g.: <ul style="list-style-type: none"> <li>• using weight feeders and precision rotary valves for petcoke feeding and/or</li> <li>• using flowmeters and precision valves for heavy oil or gas feeding regulation to the kiln burner</li> </ul>

**Applicability**

The techniques for the reduction of CO emissions are generally applicable to the magnesia industry. The selection of raw materials with a low content of organic matter is subject to raw materials availability.

**BAT-associated emission levels**

The BAT-AEL for the emissions of CO from the flue-gases of kiln firing processes is <50 – 1000 mg/Nm<sup>3</sup>, as the daily average value.

**4.4.4.3.2 Reduction of CO trips**

**64. In order to minimise the number of CO trips when applying ESPs, BAT is to use the following techniques:**

	<b>Technique</b>
a	Manage CO trips in order to reduce the ESP downtime
b	Continuous automatic CO measurements by means of monitoring equipment with a short response time and situated close to the CO source

**Description**

For safety reasons, due to the risk of explosions, ESPs will have to shut down during elevated CO levels in the flue-gases. The following techniques prevent CO trips and, therefore, reduce ESP shutdown times:

- control of the combustion process
- control of the organic load of raw materials
- control of the quality of the fuels and fuel feeding system

Disruptions predominantly happen during the start-up operation phase. For safe operation, the gas analysers for ESP protection have to be on-line during all operational phases and the ESP downtime can be reduced by using a backup monitoring system maintained in operation.

The continuous CO monitoring system needs to be optimised for reaction time and should be located close to the CO source, e.g. at a preheater tower outlet, or at a kiln inlet in the case of a wet kiln application.

#### Applicability

Generally applicable to kilns fitted with electrostatic precipitators (ESPs).

#### 4.4.4.4 SO<sub>x</sub> emissions

65. In order to reduce the emissions of SO<sub>x</sub> from the flue-gases of kiln firing processes, BAT is to use a combination of the following primary and secondary techniques:

	Technique	Applicability
a	Process optimisation techniques	Generally applicable
b	Selecting fuels with a low sulphur content	Generally applicable subject to availability of low sulphur fuels which may be impacted by the energy policy of the Member State. The selection of fuel also depends on the quality of the final product, technical possibilities and economic considerations
c	A dry absorbent addition technique (sorbet addition into the flue gas stream such as reactive MgO grades, hydrated lime, activated carbon, etc.), in combination with a filter <sup>(1)</sup>	Generally applicable
d	Wet scrubber	The applicability may be limited in arid areas by the large volume of water necessary and the need for waste water treatment and the related cross-media effects

<sup>(1)</sup> A description of the measure/technique is provided in Section 4.7.2

#### BAT-associated emission levels

See Table 4.15.

Table 4.15: BAT-associated emission levels for SO<sub>x</sub> from flue-gases of kiln firing processes in the magnesia industry

Parameter	Unit	BAT-AEL <sup>(1)</sup> <sup>(2)</sup> (daily average value or average over the sampling period (spot measurements for at least half an hour))
SO <sub>x</sub> expressed as SO <sub>2</sub>	mg/Nm <sup>3</sup>	<50 – 400 <sup>(3)</sup>

<sup>(1)</sup> The BAT-AELs depend on the content of sulphur in the raw materials and fuels. The lower end of the range is associated with the use of raw materials with low sulphur content and the use of natural gas; the upper end of the range is associated with the use of raw materials with higher sulphur content and/or the use of sulphur-containing fuels.

<sup>(2)</sup> Cross-media effects should be taken into account to assess the best combination of BAT to reduce SO<sub>x</sub> emissions.

<sup>(3)</sup> When a wet scrubber is not applicable, BAT-AELs depend on the sulphur content of raw materials and fuels. In this case, the BAT-AEL is <1500 mg/Nm<sup>3</sup> while ensuring a SO<sub>x</sub> emissions removal efficiency of at least 60 %.

#### 4.4.5 Process losses/waste

66. In order to reduce/minimise process losses/waste, BAT is to reuse various types of collected magnesium carbonate dusts in the process wherever practicable.

##### Applicability

Generally applicable, subject to dust chemical composition.

67. In order to reduce/minimise process losses/waste, BAT is to utilise, when possible, the various types of collected magnesium carbonate dusts in other marketable products when these are not recyclable.

##### Applicability

The utilisation of magnesium carbonate dusts in other marketable products may not be within the control of the operator.

68. In order to reduce/minimise process losses/waste, BAT is to reuse sludge resulting from the wet process of the flue-gas desulphurisation in the process or in other sectors.

##### Applicability

The utilisation of sludge resulting from the wet process of the flue-gas desulphurisation in other sectors may not be within the control of the operator.

#### 4.4.6 Use of wastes as fuels and/or raw materials

69. In order to guarantee the characteristics of waste to be used as fuels and/or raw materials in magnesium oxide kilns, BAT is to use the following techniques:

	Technique
a	To select suitable wastes for the process and the burner
b	To apply quality assurance systems to guarantee and control the characteristics of wastes and to analyse any waste that is to be used for: <ol style="list-style-type: none"> <li>I. availability</li> <li>II. constant quality</li> <li>III. physical criteria, e.g. emissions formation, coarseness, reactivity, burnability, calorific value</li> <li>IV. chemical criteria, e.g. chlorine, sulphur, alkali and phosphate content and relevant metals (e.g. total chromium, lead, cadmium, mercury, thallium) content</li> </ol>
c	To control the amount of relevant parameters for any waste that is to be used, such as total halogen content, metals (e.g. total chromium, lead, cadmium, mercury, thallium) and sulphur

##### Applicability

Wastes may be used as fuels and/or raw materials in the magnesia industry (although they had not yet been applied in the magnesia industry in 2007) subject to availability, the type of kiln used, the desired product qualities and the technical possibility of feeding the fuels into the kiln.

## DESCRIPTION OF TECHNIQUES

### 4.5 Description of techniques for the cement industry

#### 4.5.1 Dust emissions

	Technique	Description
a	Electrostatic precipitators	<p>Electrostatic precipitators (ESPs) generate an electrostatic field across the path of particulate matter in the air stream. The particles become negatively charged and migrate towards positively charged collection plates. The collection plates are rapped or vibrated periodically, dislodging the material so that it falls into collection hoppers below. It is important that ESP rapping cycles be optimised to minimise particulate re-entrainment and thereby minimise the potential to affect plume visibility.</p> <p>ESPs are characterised by their ability to operate under conditions of high temperatures (up to approximately 400 °C) and high humidity. The major disadvantages of this technique are their decreased efficiency with an insulating layer and a build-up of material that may be generated with high chlorine and sulphur inputs. For the overall performance of ESPs, it is important to avoid CO trips</p> <p>Even though there are no technical restrictions on the applicability of ESPs in the various processes in the cement industry, they are not often chosen for cement mill dedusting because of the investment costs and the efficiency (relatively high emissions) during start-ups and shutdowns</p>
b	Fabric filters	<p>Fabric filters are efficient dust collectors. The basic principle of fabric filtration is to use a fabric membrane which is permeable to gas but which will retain the dust. Basically, the filter medium is arranged geometrically. Initially, dust is deposited both on the surface fibres and within the depth of the fabric, but as the surface layer builds up, the dust itself becomes the dominating filter medium. Off-gas can flow either from the inside of the bag outwards or vice versa. As the dust cake thickens, the resistance to gas flow increases. Periodic cleaning of the filter medium is therefore necessary to control the gas pressure drop across the filter. The fabric filter should have multiple compartments which can be individually isolated in case of bag failure and there should be sufficient of these to allow adequate performance to be maintained if a compartment is taken off line. There should be 'burst bag detectors' in each compartment to indicate the need for maintenance when this happens. Filter bags are available in a range of woven and non-woven fabrics. Modern synthetic fabrics can operate at quite high temperatures of up to 280 °C.</p> <p>The performance of fabric filters is mainly influenced by different parameters, such as compatibility of the filter medium with the characteristics of the flue-gas and the dust, suitable properties for thermal, physical and chemical resistance, such as hydrolysis, acid, alkali, and oxidation and process temperature. Moisture and temperature of the flue-gases have to be taken into consideration during the selection of the technique.</p>
c	Hybrid filters	<p>Hybrid filters are the combination of ESPs and fabric filters in the same device. They generally result from the conversion of existing ESPs. They allow the partial reuse of the old equipment</p>

4.5.2 NO<sub>x</sub> emissions

	Technique	Description
a	Primary measures/techniques	
	I Flame cooling	The addition of water to the fuel or directly to the flame by using different injection methods, such as injection of one fluid (liquid) or two fluids (liquid and compressed air or solids) or the use of liquid/solid wastes with a high water content reduces the temperature and increases the concentration of hydroxyl radicals. This can have a positive effect on NO <sub>x</sub> reduction in the burning zone
	II Low NO <sub>x</sub> burners	<p>Designs of low NO<sub>x</sub> burners (indirect firing) vary in detail but essentially the fuel and air are injected into the kiln through concentric tubes. The primary air proportion is reduced to some 6 – 10 % of that required for stoichiometric combustion (typically 10 – 15 % in traditional burners). Axial air is injected at high momentum in the outer channel. The coal may be blown through the centre pipe or the middle channel. A third channel is used for swirl air, its swirl being induced by vanes at, or behind, the outlet of the firing pipe. The net effect of this burner design is to produce very early ignition, especially of the volatile compounds in the fuel, in an oxygen-deficient atmosphere, and this will tend to reduce the formation of NO<sub>x</sub>.</p> <p>The application of low NO<sub>x</sub> burners is not always followed by a reduction of NO<sub>x</sub> emissions. The set-up of the burner has to be optimised</p>
	III Mid kiln firing	<p>In long wet and long dry kilns, the creation of a reducing zone by firing lump fuel can reduce NO<sub>x</sub> emissions. As long kilns usually have no access to a temperature zone of about 900 – 1000 °C, mid-kiln firing systems can be installed in order to be able to use waste fuels that cannot pass the main burner (for example tyres).</p> <p>The rate of the burning of fuels can be critical. If it is too slow, reducing conditions can occur in the burning zone, which may severely affect product quality. If it is too high, the kiln chain section can be overheated – resulting in the chains being burned out. A temperature range of less than 1100 °C excludes the use of hazardous waste with a chlorine content of greater than 1 %</p>
	IV Addition of mineralisers to improve the burnability of the raw meal (mineralised clinker)	The addition of mineralisers, such as fluorine, to the raw material is a technique to adjust the clinker quality and allow the sintering zone temperature to be reduced. By reducing/lowering the burning temperature, NO <sub>x</sub> formation is also reduced
	V Process optimisation	Optimisation of the process, such as smoothing and optimising the kiln operation and firing conditions, optimising the kiln operation control and/or homogenisation of the fuel feedings, can be applied for reducing NO <sub>x</sub> emissions. General primary optimisation measures/techniques, such as process control measures/techniques, an improved indirect firing technique, optimised cooler connections and fuel selection, and optimised oxygen levels have been applied



	Technique	Description
b	Staged combustion (conventional or waste fuels), also in combination with a precalciner and the use of optimised fuel mix	Staged combustion is applied at cement kilns with an especially designed precalciner. The first combustion stage takes place in the rotary kiln under optimum conditions for the clinker burning process. The second combustion stage is a burner at the kiln inlet, which produces a reducing atmosphere that decomposes a portion of the nitrogen oxides generated in the sintering zone. The high temperature in this zone is particularly favourable for the reaction which reconverts the NO <sub>x</sub> to elementary nitrogen. In the third combustion stage, the calcining fuel is fed into the calciner with an amount of tertiary air, producing a reducing atmosphere there, too. This system reduces the generation of NO <sub>x</sub> from the fuel, and also decreases the NO <sub>x</sub> coming out of the kiln. In the fourth and final combustion stage, the remaining tertiary air is fed into the system as 'top air' for residual combustion
c	SNCR	Selective non-catalytic reduction (SNCR) involves injecting ammonia water (up to 25 % NH <sub>3</sub> ), ammonia precursor compounds or urea solution into the combustion gas to reduce NO to N <sub>2</sub> . The reaction has an optimum effect in a temperature window of about 830 to 1050 °C, and sufficient retention time must be provided for the injected agents to react with NO
d	SCR	SCR reduces NO and NO <sub>2</sub> to N <sub>2</sub> with the help of NH <sub>3</sub> and a catalyst at a temperature range of about 300 – 400 °C. This technique is widely used for NO <sub>x</sub> abatement in other industries (coal fired power stations, waste incinerators). In the cement industry, basically two systems are considered: low dust configuration between a dedusting unit and stack, and a high dust configuration between a preheater and a dedusting unit. Low dust flue-gas systems require the reheating of the flue-gases after dedusting, which may cause additional energy costs and pressure losses. High dust systems are considered preferable for technical and economical reasons. These systems do not require reheating, because the waste gas temperature at the outlet of the preheater system is usually in the right temperature range for SCR operation

4.5.3 SO<sub>x</sub> emissions

	Technique	Description
a	Absorbent addition	<p>Absorbent is either added to the raw materials (e.g. hydrated lime addition) or injected into the gas stream (e.g. hydrated or slaked lime (Ca(OH)<sub>2</sub>), quicklime (CaO), activated fly ash with a high CaO content or sodium bicarbonate (NaHCO<sub>3</sub>)).</p> <p>Hydrated lime can be charged into the raw mill together with the raw material constituents or directly added to the kiln feed. The addition of hydrated lime offers the advantage that the calcium-bearing additive forms reaction products that can be directly incorporated into the clinker-burning process.</p> <p>Absorbent injection into the gas stream can be applied in a dry or wet form (semi-dry scrubbing). The absorbent is injected into the flue-gas path at temperatures close to the water dew point, which results in more favourable conditions for SO<sub>2</sub> capture. In cement kiln systems, this temperature range is usually reached in the area between the raw mill and the dust collector</p>
b	Wet scrubber	<p>The wet scrubber is the most commonly used technique for flue-gas desulphurisation in coal-fired power plants. For cement manufacturing processes, the wet process for reducing SO<sub>2</sub> emissions is an established technique. Wet scrubbing is based on the following chemical reaction:</p> $\text{SO}_2 + \frac{1}{2} \text{O}_2 + 2 \text{H}_2\text{O} + \text{CaCO}_3 \longleftrightarrow \text{CaSO}_4 \cdot 2 \text{H}_2\text{O} + \text{CO}_2$ <p>SO<sub>x</sub> are absorbed by a liquid/slurry which is sprayed in a spray tower. The absorbent is generally calcium carbonate. Wet scrubbing systems provide the highest removal efficiencies for soluble acid gases of all flue-gas desulphurisation (FGD) methods with the lowest excess stoichiometric factors and the lowest solid waste production rate. The technique requires certain amounts of water with a consequent need for waste water treatment</p>

## 4.6 Description of techniques for lime industry

### 4.6.1 Dust emissions

	Technique	Description
a	ESP	<p>A general description of ESPs is provided in Section 1.5.1.</p> <p>ESPs are suitable for use at temperatures above the dew point and up to 400 °C. Furthermore, it is also possible to use ESPs close to, or below, the dew point. Because of high volume flows and relatively high dust loads, mainly rotary kilns without preheaters but also rotary kilns with preheaters are equipped with ESPs. In the case of combination with a quenching tower, excellent performance can be achieved</p>
b	Fabric filter	<p>A general description of fabric filters is provided in Section 1.5.1.</p> <p>Fabric filters are well suited for kilns, milling and grinding plants for quicklime as well as for limestone; hydration plants; material transport; and storage and loading facilities. Often a combination with cyclone prefilters is useful. The operation of fabric filters is limited by the flue-gas conditions such as temperature, moisture, dust load and chemical composition. There are various fabric materials available to resist mechanical, thermal and chemical wear to meet those conditions</p>
c	Wet dust separator	<p>With wet dust separators, dust is eliminated from off-gas streams by bringing the gas flow into close contact with a scrubbing liquid (usually water), so that the dust particles are retained in the liquid and can be rinsed away. There are a number of different types of wet scrubbers available for dust removal. The main types that have been used in lime kilns are multi-cascade/multistage wet scrubbers, dynamic wet scrubbers and venturi wet scrubbers. The majority of wet scrubbers used on lime kilns are multi-cascade/multistage wet scrubbers.</p> <p>Wet scrubbers are chosen when the flue-gas temperatures are close to, or below the dew point. They may also be chosen when space is limited. Wet scrubbers are sometimes used with higher temperature gases, in which case, the water cools the gases and reduces their volume</p>
d	Centrifugal Separator/cyclone	<p>In a centrifugal separator/cyclone, the dust particles to be eliminated from an off-gas stream are forced out against the outer wall of the unit by centrifugal action and then eliminated through an aperture at the bottom of the unit. Centrifugal forces can be developed by directing the gas flow in a downward spiral motion through a cylindrical vessel (cyclonic separators) or by a rotating impeller fitted in the unit (mechanical centrifugal separators). However, they are only suitable as pre-separators because of their limited particle removal efficiency and they relieve ESPs and fabric filters from high dust loading, and reduce abrasion problems</p>

### 4.6.2 NO<sub>x</sub> emissions

	Technique	Description
a	Burner design (low NO <sub>x</sub> burner)	The low NO <sub>x</sub> burners are useful for reducing the flame temperature and thus reducing thermal and (to some extent) fuel derived NO <sub>x</sub> . The NO <sub>x</sub> reduction is achieved by supplying rinsing air for lowering the flame temperature or pulsed operation of the burners. Low NO <sub>x</sub> burners are designed to reduce the primary air portion which leads to lower NO <sub>x</sub> formation whereas common multi-channel burners are operated with a primary air portion of 10 to 18 % of the total combustion air. The higher portion of the primary air leads to a short and intensive flame by the early mixing of hot secondary air and fuel. This results in high flame temperatures along with a creation of a high amount of NO <sub>x</sub> formation which can be avoided by using low NO <sub>x</sub> burners
b	Air staging	A reducing zone is created by reducing the oxygen supply in the primary reaction zones. High temperatures in this zone are particularly favourable for the reaction which reconverts the NO <sub>x</sub> to elementary nitrogen. At later combustion zones, the air and oxygen supply is increased to oxidise the gases formed. Effective air/gas mixing in the firing zone is required to ensure that CO and NO <sub>x</sub> are both maintained at low levels.  In 2007, air staging had never been applied in the lime sector
c	SNCR	Nitrogen oxides (NO and NO <sub>2</sub> ) from the flue-gases are removed by selective non-catalytic reduction and converted into nitrogen and water by injecting a reducing agent into the kiln which reacts with the nitrogen oxides. Ammonia or urea is typically used as the reducing agent. The reactions occur at temperatures of between 850 and 1020 °C, with the optimal range typically between 900 to 920 °C

### 4.6.3 SO<sub>x</sub> emissions

	Technique	Description
a	Absorbent addition techniques	The technique involves the addition of an absorbent in dry form directly into the kiln (fed or injected) or in dry or wet form (e.g. hydrated lime or sodium bicarbonate) into the flue-gases in order to remove SO <sub>x</sub> emissions. When absorbent is injected into the flue-gases, a sufficient residence time between the injection point and the dust collector (fabric filter or ESP) must be provided in order to obtain an efficient absorption.  For rotary kilns, absorption techniques may include: <ul style="list-style-type: none"> <li>• Use of fine limestone: At a straight rotary kiln fed with dolomite, significant reductions in SO<sub>2</sub> emissions can occur with feedstones which either contain high levels of finely divided limestone or are prone to break up on heating. The finely divided limestone calcines are entrained in the kiln gases and remove SO<sub>2</sub> en route to, and in, the dust collector.</li> <li>• Lime injection into the combustion air: A patented technique (EP 0 734 755 A1) which removes SO<sub>2</sub> emissions from rotary kilns by injecting finely divided quick or hydrated lime into the air fed into the firing hood of the kiln</li> </ul>

## 4.7 Description of techniques for the magnesia industry (dry process route)

### 4.7.1 Dust emissions

	Measure/Technique	Description
a	Electrostatic precipitators (ESPs)	A general description of ESPs is provided in Section 1.5.1
b	Fabric filters	<p>A general description of fabric filters is provided in Section 1.5.1</p> <p>Fabric filters receive high particle retention, typically over 98 % and up to 99 % depending on the particle size. This technique offers the best efficiency on particle collection in comparison to other dust abatement measures/techniques used in the magnesia industry. However, because of the high temperatures of the kiln flue-gases, special filter materials which can tolerate high temperatures have to be used.</p> <p>In DBM manufacturing, filter materials operating with temperatures of up to 250 °C are used, such as PTFE (Teflon) filter material. This filter material shows good resistance to acids or alkalis and a lot of corrosion problems have been solved</p>
c	Cyclones (centrifugal separator)	A general description of cyclones is provided in Section 1.6.1. They are robust equipment and they have a wide operational temperature range with a low energy requirement. Because of the system-dependent limited degree of separation, cyclones are mainly used as preliminary separators for coarse dust and flue-gases
d	Wet dust separators	<p>General description of wet dust separators (also called wet scrubbers) is provided in Section 1.6.1</p> <p>Wet dust separators can be divided into various types according to their design and working principles, such as the venturi type. This type of wet dust separator has a number of applications in the magnesia industry, including when gas is directed through the narrowest section of the venturi tube, the 'venturi neck', and gas velocities of between 60 and 120 m/s can be achieved. The washing fluids which are fed into the venturi tube neck are diffused into a mist of very fine droplets and are intensively mixed with the gas. The particles separated onto the water droplets become heavier and can be readily drawn off using a drop separator installed in this venturi wet dust separator</p>

**4.7.2 SO<sub>x</sub> emissions**

	<b>Technique</b>	<b>Description</b>
a	Absorbent addition technique	The technique involves the injection of an absorbent in dry or wet form (semi-dry scrubbing) into the flue-gases in order to remove SO <sub>x</sub> emissions. A sufficient gas residence time between the injection point and the dust collector is very important to obtain highly efficient absorption. Reactive MgO grades can be used as efficient absorbents for SO <sub>2</sub> in the magnesia industry. Despite the lower efficiency compared to other absorbents, the use of reactive MgO grades has a double advantage as it lowers the investment costs and also the filter dust is not contaminated by other substances and can be reused in place of raw materials for the production of magnesia or employed as a fertiliser (magnesium sulphate) minimising waste generation
b	Wet scrubber	In the wet scrubbing technique, SO <sub>x</sub> are absorbed by a liquid/slurry which is sprayed countercurrently to the flue-gases in a spray tower. The technique requires an amount of water between 5 and 12 m <sup>3</sup> /tonne product, with a consequent need for a waste water treatment

## 5 CONCLUDING REMARKS AND RECOMMENDATIONS FOR FUTURE WORK

**\*\* NOTE to Article 13 Forum members: The concluding remarks and recommendations for future works have been combined in this new Chapter 5. The text has been slightly amended according to the new standard text for this chapter and the CLM specificities.\*\***

### **Timing of the review process of the CLM BREF and the transformation under IED**

The kick-off meeting for the review of the cement and lime BREF document was held in September 2005 **under the framework of the IPPC Directive**. The TWG agreed to extend the scope of this document and to add an additional industrial sector on magnesium oxide (MgO/magnesia) production using the dry process route to the cement and lime BREF. After the period for collecting information and data, a second TWG meeting was held in February 2007 in order to verify and agree on information and data that should be used for the revision of the BREF document. Furthermore, the TWG asked for a procedural exception for the review process of this document in order to split the discussions on Sections 1 – 4 and the BAT sections for the three chapters on cement, lime and magnesium oxide.

Based on the TWG request and taking into account the generic schedule for the review of BREFs (December 2005), the IEF agreed to split the discussions on Sections 1 – 4 and the BAT sections for the three chapters on cement, lime and magnesium oxide.

The first draft **of the revised CLM BREF** was issued for consultation in September 2007. The second part of the first draft covering the sections on techniques to consider in the determination of BAT and the BAT **conclusions was** issued for consultation in May 2008. The final TWG meeting was held in September 2008.

Based on the generic schedule for the review of BREFs (December 2005), the revision of the cement and lime BREF document did not entail a complete redraft of the first document adopted in December 2001 but updated the existing, and included additional information which was reviewed (for instance regarding techniques) as it could have had impact on BAT conclusions. The information exchange and data gathering was based on the wishes of the TWG and on the conclusions agreed at the second TWG meeting (January 2007).

**The CLM BREF was adopted and published in 2010 under the framework of the IPPC Directive (2008/1/EC). In February 2012, the European Commission decided to proceed with the transformation of the CLM BREF into a document, for which the BAT conclusions can be used for implementing the IED. Draft BAT conclusions were issued for consultation with the TWG in February 2012. A TWG meeting was held in May 2012 in order to discuss the draft BAT conclusions and verify that they accurately reflect the technical content of the conclusions agreed by the TWG at the final TWG meeting in September 2008 under the framework of the IPPC Directive. The current document contains the BAT conclusions transformed for the adoption under Directive 2010/75/EU. During the adaptation of the CLM BREF to the provisions of the IED, BAT conclusions for all three sectors were aggregated in a new Chapter 4 and the existing concluding remarks in a new Chapter 5.**

### **5.1 Cement sector**

#### **Sources of information and information gaps**

The revised cement chapter is based on a large number of documents and on over 50 sources of information from both industry and Member States. The reports were submitted by CEMBUREAU, the industry association representing the majority of European cement manufacturers and the Member States Germany, Austria, Sweden, France, the United Kingdom,

Ireland, the Netherlands, Italy, Hungary, Estonia, Spain, Portugal, Finland and the Czech Republic. Furthermore, information was provided by EURITS, the industry association representing the majority of the EU's hazardous waste incineration sector and by a supplier from Norway. These documents can be considered as the building blocks of the revised parts of this cement chapter.

Additional useful information was obtained by visiting cement manufacturing sites in the UK, Austria, Germany, Belgium, Spain, Finland and Hungary.

Despite much very useful information and many comments regarding several different issues, some data problems and their consequences for this cement chapter have to be pointed out:

- there is a lack of information regarding the frequency of measurements, i.e. in the case of periodic measurements
- there is a lack of information on the issue of mercury emissions and the link between mercury emissions and the technical options which are available for reducing mercury
- to a certain extent, there is a lack of consistent information regarding monitoring techniques and measurement systems for emissions, e.g. mercury emissions
- regarding the use of activated carbon, information and data were provided only for SO<sub>x</sub> emissions reduction rather than being considered as a multi pollutant reduction technique for several other emissions to air
- input data were provided regarding the use of waste which are different in the EU-27 in terms of, e.g. characteristics and parameters because of plant specific data. The data which were submitted in this context show many specific details, but lead to the conclusion that it is difficult to make general quantitative statements regarding this issue and the corresponding BAT conclusion is based on a qualitative approach
- as an emerging technique, fluidised bed technique for cement manufacturing is described (see Section 1.5.1); however, there was no information provided by the TWG as to how this technique should be/can be further developed.

During the final CLM TWG meeting, a detailed discussion regarding the source and possible reduction techniques of mercury emissions took place. The discussion showed the following:

- the level of mercury emissions is mainly influenced by the raw material composition. Regarding the emissions data provided it was shown that levels of below 0.05 mg/Nm<sup>3</sup> can be achieved; however, there was no evidence available as to where these lower levels came from. CEMBUREAU agreed to do research on this issue in order to get a better understanding of these mercury emissions and how this issue relates to all plants. CEMBUREAU will try to come up with a full set of data related to this issue for the next review of this CLM BREF document
- continuous monitoring of mercury emissions is carried out in Germany and Austria due to legally binding requirements to monitor mercury continuously (in Germany since 2000). In 2008 in the German cement industry, 34 mercury CEMs (Continuous Emissions Monitors) were in operation. The monitoring devices were under research and in general until 2008, the performance of CEMs were improved in order to work properly and to deliver reliable results. It was generally found that in some cases additional maintenance had to be carried out. In some other cases, it was necessary in accordance with the competent authority to modify the commercially available devices to make them suitable for individual application. There are only rare cases (10 %) where CEMs cannot be used properly. Final conclusions on the long term stability of these devices are not yet available. Intervals for a periodic maintenance of CEMs have to be adjusted based on future experiences. In October 2007, the German UBA asked suppliers and providers of these mercury measurement devices about their experiences. As a result, guidelines for quality assurance are now available which also set requirements for the maintenance procedure for most of the CEMs. Furthermore, proper calibration of CEMs according to the European standard EN 14181 is a challenge. In the case of mercury CEMs, this calibration procedure needs greater effort than for CEMs for other emissions, e.g. dust or



NO<sub>x</sub>. Periodic quality assurance procedures should be carried out by experienced personnel only. The ongoing development process should be followed. The outcome should be taken into consideration for the next review of this CLM BREF document and information and data regarding this issue should be collected in order to make general quantitative statements on the continuous measurement of mercury emissions.

The ongoing research process should be followed and investigations should be made in terms of improvements and further developments. The outcome should be taken into consideration for the next review of this CLM BREF document and information and data regarding this issue should be collected in order to make general quantitative statements on the continuous measurement of mercury emissions.

### **Degree of consensus reached during the information exchange**

The conclusions of the work regarding the cement chapter were agreed at the final TWG meeting in September 2008 and the TWG meeting in May 2012. A high level of consensus was achieved on BAT (best available techniques) conclusions for the cement industry and no split views were recorded.

### **Recommendations for future work**

The information exchange and its result for the cement industry, i.e. the cement chapter of this document, present an important step forward in achieving the integrated prevention and control of pollution for cement manufacturing. Further work on the following issues could continue the process:

- collect data by taking into account the guidance set out in the Commission Implementing Decision 2012/119/EU on the collection of data and on the drawing up of BAT reference documents, to allow an assessment of the performance of certain techniques at the plant level, especially potential BAT
- collect information regarding the relationship between process type, waste (type, amounts) used and emissions
- collect costs data (e.g. investment, operational costs) regarding all techniques to consider in the determination of BAT
- collect costs data along with the reduction efficiencies of abatement techniques
- collect information and data regarding options for minimising energy consumption or for increasing energy efficiency
- collect data on energy consumption along with best performance data related to kiln types used
- collect information and data regarding the reduction of NO<sub>x</sub> emissions especially regarding the SCR and SNCR technique
- collect information regarding NH<sub>3</sub> emissions
- collect more information regarding activated carbon considered as a multi pollutant reduction measure/technique, e.g. for SO<sub>x</sub> emissions reduction
- collect information regarding emissions monitoring and monitoring frequencies, e.g. for periodic measurements, so that authorities are able to check permit obligations/conditions
- investigate the revision of the Reference Document on the General Principles of Monitoring
- collect information and data regarding TOC emissions
- collect data and research techniques which could be used for the reduction of metals (mercury)
- collect information and data about all process input, specifically on mercury
- collect information and data regarding input criteria for waste
- collect information regarding continuous mercury emissions monitoring techniques used in the cement industry
- collect information regarding fluidised bed cement manufacturing technique

- collect information regarding the abatement technique of semi-dry scrubbers in the cement industry
- include standard methods (e.g. EN standards, ISO standards) that are used for monitoring specific pollutants in the cement industry.

### Suggested topics for future R&D work

For the use of SCR for NO<sub>x</sub> reduction in the cement industry, there is still some further work necessary regarding the development of appropriate catalysts and the further development of the process (see BAT 19 d in Section 4.2.6.1).

In particular regarding the techniques described in the Emerging Techniques section (Section 1.5), some future R&D work will still be necessary and useful, so that these techniques can be considered in future in the determination of BAT for the cement industry.

The Commission is launching and supporting, through its Research and Technological Development programmes, a series of projects dealing with clean technologies, emerging effluent treatment and recycling technologies and management strategies. Potentially, these projects could provide a useful contribution to future BREF reviews. Readers are therefore invited to inform the European IPPC Bureau of any research results which are relevant to the scope of this document (see also the fifth section of the Preface of this document).

## 5.2 Lime sector

### Sources of information and information gaps

The revised lime chapter is based on 35 documents providing information from both industry and Member States. The reports were submitted by EuLA, the industry association representing the majority of European lime manufacturers and the Member States Germany, Austria, France, Finland, Portugal, Italy, Spain, Hungary and the Czech Republic. These reports can be considered as the building blocks of this revised lime chapter of this document.

Additional useful information was obtained by visiting lime manufacturing sites in Austria, Germany and Finland.

Despite much very useful information and many comments regarding several different issues, some data problems and some of the corresponding consequences for this lime chapter have to be pointed out:

- there is a lack of information on energy consumption along with best performance data related to kiln types and different types of products; however energy consumption was brought on board for the BAT conclusions
- there is a lack of information regarding emissions monitoring and monitoring frequencies used, e.g. regarding periodic measurements
- for NO<sub>x</sub> emissions reduction and abatement, primary techniques are used. Furthermore in 2008, SNCR was only applied to Lepol kilns (one installation with four kilns). This SNCR has been in a test phase and in operation for a total of 2 years. For the use of SNCR in the lime industry, there is a lack of information and data from long term experiences, e.g. reduction efficiency along with best performance NO<sub>x</sub> emission data, NH<sub>3</sub> slip. In 2008, there was no information available as to whether, except for Lepol kilns, SNCR for NO<sub>x</sub> abatement could be applicable to other types of rotary kilns used for lime production
- for CO emissions, there is a lack of information regarding the types of other shaft kilns (OSK) which currently have emissions exceeding the BAT-AEL. For some of these shaft kiln types, their specific technical characteristics might prevent achieving the agreed

BAT-AEL for CO. Such technical characteristics could be taken into consideration by competent authorities when setting permit conditions.

- there is a lack of information regarding frequency and duration of CO trips when ESPs are applied so the corresponding BAT conclusion is based on a qualitative approach
- to a certain extent, there is a lack of information on the issue of metal emissions and the link between metal emissions (mercury) and the valuable technical options which are available and could be used to reduce them
- regarding mixed feed shaft kilns (MFSKs), there is a lack of information regarding TOC emissions and abatement. Furthermore, high CO emissions of around 2500 mg/Nm<sup>3</sup> arising from MFSKs have been reported which are influenced and determined by several factors (e.g. Boudouard reaction, see Figure 2.40). Prevention may be difficult and, to some extent, impossible. As an emerging technique, post-combustion of flue-gases could be used, however, this technique has to be further developed and researched
- as an emerging technique, fluidised bed calcination for lime manufacturing is described (see Section 2.5.1); however, there was no information provided by the TWG as to how this technique could be/can be further developed.

### Level of consensus at the final TWG meeting

The conclusions of the work regarding the lime chapter were agreed at the final TWG meeting in September 2008 and the TWG meeting in May 2012. A high level of consensus was achieved on BAT (best available techniques) conclusions for the lime industry, and no split views were recorded.

### Recommendations for future work

The information exchange and its result for the lime industry, i.e. the lime chapter of this document, present an important step forward in achieving the integrated prevention and control of pollution for lime manufacturing. Further work on the following issues could continue the process:

- collect data by taking into account the guidance set out in the Commission Implementing Decision 2012/119/EU on the collection of data and on the drawing up of BAT reference documents, to allow an assessment of the performance of certain techniques at the plant level, especially potential BAT
- collect information regarding the relationship between process type, waste (type, amounts) used and emissions
- collect costs data (e.g. investment, operational costs) regarding all techniques to consider in the determination of BAT
- collect costs data along with the reduction efficiencies of abatement techniques
- collect information and data regarding options for minimising energy consumption or for increasing energy efficiency
- collect information on energy consumption along with best performance data related to kiln types used and different types of products produced
- collect information regarding emissions monitoring and monitoring frequencies, e.g. investigate periodic emissions monitoring, so that authorities are able to check permit obligations/conditions
- investigate the revision of the Reference Document on the General Principles of Monitoring
- collect information and data regarding the use of waste (e.g. composition, input criteria)
- collect information and data regarding the use of SNCR in the lime industry for NO<sub>x</sub> emissions reduction, e.g. reduction efficiency, NH<sub>3</sub> slip
- collect more and detailed data on metal emissions and research techniques which could be used for the reduction of metals (especially mercury)
- investigate and collect data regarding frequency and duration of CO trips when applying ESPs

- for PFRKs, more investigation needs to be carried out to find a solution for dealing with the issue of TOC emissions
- for MFSKs, further information regarding CO and TOC emissions have to be collected (especially related to the development of post-combustion as described in Section 2.5.4)
- collect information regarding the fluidised bed lime manufacturing technique
- include standard methods (e.g. EN standards, ISO standards) that are used for monitoring specific pollutants in the lime industry.

### Suggested topics for future R&D work

In particular regarding the techniques described in the Emerging Techniques section (Section 2.5), some future R&D work will still be necessary and useful, so that these techniques can be considered in future in the determination of BAT for the cement industry.

The Commission is launching and supporting, through its Research and Technological Development programmes, a series of projects dealing with clean technologies, emerging effluent treatment and recycling technologies and management strategies. Potentially, these projects could provide a useful contribution to future BREF reviews. Readers are therefore invited to inform the European IPPC Bureau of any research results which are relevant to the scope of this document (see also the fifth section of the Preface of this document).

## 5.3 Magnesium oxide sector

### Sources of information and information gaps

The MgO chapter was developed from scratch and is based on six documents and on five sources of information from both industry and one Member State. The reports were submitted by EUROMINES, the industry association representing the European MgO manufacturers and the Member State Austria. These documents can be considered as the building blocks of the MgO chapter of this document.

Additional useful information was obtained by visiting one MgO manufacturing site in Austria.

It has to be noted that in 2008 in the EU-27, on the basis of the information available, there were only nine known magnesium oxide producers using 14 plants so there is a correspondingly low number of plants producing sintered magnesium oxide.

Despite much very useful information and many comments regarding several issues, some information and data problems and some of the corresponding consequences for this MgO chapter have to be pointed out:

- there is a lack of information on energy consumption for different kiln types along with specific products and best performance data. Regarding the BAT conclusion on energy consumption (BAT 56, Section 4.4.2), the range only reflects information provided for this BREF document. More specific information about best performing techniques along with the products produced was not provided
- there is a lack of information regarding monitoring and monitoring frequencies, e.g. for periodic measurements
- for NO<sub>x</sub> emissions abatement and reduction, in 2008, only primary techniques were used. Secondary techniques, e.g. SCR, SNCR are not yet applicable in the MgO industry for different technical reasons; however, this issue has to be investigated.
- there is a lack of information regarding SO<sub>x</sub> emissions coming from the raw material on the one hand, and from the fuels on the other hand, along with information on abatement techniques

- there is a lack of information regarding frequency and duration of CO trips when ESPs are applied so that the corresponding BAT conclusion is based on a qualitative approach
- there is no information regarding emerging techniques.

### Level of consensus at the final TWG meeting

The conclusions of the work regarding the MgO chapter were agreed at the final TWG meeting in September 2008 and the TWG meeting in May 2012.

Another discussion point was to explicitly mention in the conclusions and recommendations section the difficulties in handling the information which was received very late during the final TWG meeting and after the final meeting. This is particularly relevant for information and data regarding the use of sulphur rich petroleum coke (petcoke), the corresponding initial SO<sub>x</sub> emissions and the availability and applicability of SO<sub>x</sub> reduction techniques. It was pointed out and concluded by the TWG that, in general, for reducing gaseous compounds, it is BAT to apply general primary techniques individually or in combination (see Section 4.4.4.1, BAT 61). Furthermore, it was concluded by the TWG that for reduction of SO<sub>x</sub> emissions, it is BAT to apply a combination of primary and secondary techniques (see Section 4.4.4.4, BAT 65).

At the final meeting, there was also a detailed discussion regarding the BAT-AELs for SO<sub>x</sub> emissions, especially in the case of a sulphur content of >0.25 % in the raw material (see BAT 65 in Section 4.4.4.4). Several TWG members representing the magnesium oxide industry were of the opinion that this BAT-AEL cannot be achieved because of very high initial SO<sub>x</sub> levels, mainly resulting from the use of sulphur rich fuels. However, detailed convincing technical arguments specified that by using a combination of primary and secondary techniques (see BAT 61 and BAT 65), SO<sub>x</sub> emissions of 400 mg/Nm<sup>3</sup> (as a daily average value) can be achieved, in particular with the use of wet scrubber. No rationale for supporting a SO<sub>x</sub> BAT-AEL higher than 400 mg/Nm<sup>3</sup> could be provided by TWG members. However, the TWG agreed that in exceptional cases, due to raw material compositions, SO<sub>2</sub> emission levels could be higher than 400 mg/Nm<sup>3</sup>. TWG members representing the magnesium oxide industry referred to very high initial SO<sub>x</sub> levels before abatement by using sulphur rich petcoke as the only fuel.

It was pointed out that several types of petcoke are available on the market. Information regarding fuel selection along with fuel comparison with regard to specific costs and sulphur content are available in the BREF document (see Section 3.4.5, Figure 3.13). However, information regarding different types of petcoke containing various amounts of sulphur was not provided. Furthermore, by applying a fuel switch to a fuel other than petcoke, or even to a type of petcoke containing less sulphur, if possible, the initial SO<sub>x</sub> level could be reduced (see Section 4.4.4.1, BAT 61). Additionally, a combination of primary and secondary techniques has to be applied as concluded in BAT 65 (see Section 4.4.4.4). Furthermore, cross-media effects should be taken into account to assess the best combination of BAT to reduce SO<sub>x</sub> emissions. Article 15(4) of the Industrial Emissions Directive (2010/75/EU) can be used in relation to the local considerations which could justify the permit conditions.

At the final TWG meeting in September 2008, a general level of consensus was achieved on BAT (best available techniques) for the MgO industry and no split views were recorded.

However, after the final CLM TWG meeting Euromines and MgO industry expressed their concerns about the BAT-AELs for SO<sub>x</sub> emissions, the applicability of the available abatement techniques and the associated cross-media effects (overall environmental protection). The issue was discussed in details during the CLM TWG meeting in May 2012. A final conclusion was reached concerning the BAT for SO<sub>x</sub> emissions in the MgO industry, with a high level of consensus.

### Recommendations for future work

The information exchange and its result for the magnesium oxide industry, i.e. the magnesium oxide chapter of this document, present an important step forward in achieving the integrated prevention and control of pollution for magnesium oxide manufacturing. Further work on the following issues could continue the process:

- collect data by taking into account the **guidance set out in the Commission Implementing Decision 2012/119/EU on the collection of data and on the drawing up of BAT reference documents**, to allow an assessment of the performance of certain techniques at the plant level, especially potential BAT
- collect costs data (e.g. investment, operational costs) regarding all techniques to consider in the determination of BAT
- collect costs data along with the reduction efficiencies of abatement techniques
- collect information and data regarding options for minimising energy consumption or for increasing energy efficiency
- collect information regarding monitoring and monitoring frequencies and investigate them further, e.g. for periodic measurements, so that authorities are able to check permit obligations/conditions
- investigate the revision of the Reference Document on the General Principles of Monitoring
- collect information on energy consumption for different kiln types along with specific products
- carry out research and further development on primary techniques for NO<sub>x</sub> reduction
- carry out research and development in order to apply SNCR or SCR for the reduction of NO<sub>x</sub> emissions to the magnesium oxide industry and collect information and data regarding this issue
- collect information regarding the sulphur content in raw materials and fuels along with economic data
- investigate further and collect further information regarding the applicability of SO<sub>x</sub> abatement techniques (primary and secondary techniques), their potential cross-media effects, the availability of fuels with a low content of sulphur, the applicability of fuel switch to a fuel with a low content of sulphur and collect information on SO<sub>x</sub> emissions resulting from raw materials and/or fuels
- investigate and collect data regarding the frequency and duration of CO trips when applying ESPs
- investigate whether emerging techniques are available
- **include standard methods (e.g. EN standards, ISO standards) that are used for monitoring specific pollutants in the magnesium oxide industry**

### Suggested topics for future R&D work

**Some R&D work might be useful for the magnesium oxide industry in order to investigate emerging techniques which currently do not exist for the sector.**

**The Commission is launching and supporting, through its Research and Technological Development programmes, a series of projects dealing with clean technologies, emerging effluent treatment and recycling technologies and management strategies. Potentially, these projects could provide a useful contribution to future BREF reviews. Readers are therefore invited to inform the European IPPC Bureau of any research results which are relevant to the scope of this document (see also the fifth section of the Preface of this document).**

## 5.4 Consultation of the Forum and subsequent formal adoption procedure of the BAT Conclusions

**\*\* NOTE to Article 13 Forum members:** In this short section (no more than 10 lines) the outcome of adoption procedure will be inserted, indicating any issues that had to be resolved at that stage; e.g.:

- the dates of
  - Forum meeting during which opinion on draft BREF was delivered
  - IED Article 75 Committee meeting during which vote on draft Commission Implementing Decision was held
  - formal adoption by the Commission of the BAT conclusions

the main outcome of the Forum and Committee in terms of resolved issues, with neither specifications nor positions of individual members.

WORKING DRAFT IN PRC

---

WORKING DRAFT IN PROGRESS

---



## 6 ANNEXES

### 6.1 EC environmental legislation applicable to the production of cement and lime in the EU-27

- European Waste Catalogue (EWC), which was developed pursuant to Article 1(a) of Council Directive 75/442/EEC on waste:
  - Commission Decision 2000/532/EC of 3 May 2000 replacing Decision 94/3/EC establishing a list of wastes pursuant to Article 1(a) of Council Directive 75/442/EEC on waste and Council Decision 94/904/EC establishing a list of hazardous waste pursuant to Article 1(4) of Council Directive 91/689/EEC on hazardous waste (notified under document number C(2000) 1147) (Text with EEA relevance)
- Council Directive 2004/8/EC on the promotion of cogeneration based on a useful heat demand in the integral energy market and amending Directive 92/42/EEC (11 February 2004).

WORKING DRAFT IN PROGRESS

## 6.2 Annex cement manufacturing

### 6.2.1 CEMBUREAU's waste fuel groupings versus those of the EWC

**\*\* NOTE to Article 13 Forum members: Table has been updated as it included codes that did not correspond to valid EWC codes or the waste description was given according to an old version of the EWC\*\***

<b>Group 1: Wood, paper, cardboard</b>		
<b>Waste category</b>	<b>Waste description</b>	<b>Hazardous</b>
Category 02	Wastes from agriculture, horticulture, aquaculture, forestry, hunting and fishing, food preparation and processing	
02 01 07	Waste from forestry	
Category 03	Wastes from wood processing and the production of panels and furniture, pulp, paper and cardboard	
03 01 04	Sawdust, shavings, cuttings, wood, particle board and veneer* containing dangerous substances	
03 01 05	Sawdust, shavings, cuttings, wood, particle board and veneer other than those mentioned in 03 01 04	
03 03 07	Mechanically separated rejects from pulping of waste paper and cardboard	
Category 15	Waste packaging; absorbents, wiping cloths, filter materials and protective clothing not otherwise specified	
15 01 01	Paper and cardboard packaging	
15 01 03	Wooden packaging	
Category 17	Construction and demolition wastes (including excavated soil from contaminated sites)	
17 02 01	Wood	
Category 20	Municipal wastes (household waste and similar commercial, industrial and institutional wastes) including separately collected fractions	
20 01 01	Paper and cardboard	
20 01 37	Wood containing dangerous substances	*
<b>Group 2: Textiles</b>		
<b>Waste category</b>	<b>Waste description</b>	<b>Hazardous</b>
Category 04	Wastes from the leather, fur and textile industries	
04 02	Waste from the textile industry	
Category 15	Waste packaging; absorbents, wiping cloths, filter materials and protective clothing not otherwise specified	
15 01 09	Textile packaging	
Category 19	Wastes from waste management facilities, off-site waste water treatment plants and the preparation of water intended for human consumption and water for industrial use	
19 12 08	Textiles	
Category 20	Municipal wastes (household waste and similar commercial, industrial and institutional wastes) including separately collected fractions	
20 01 10	Clothes	
<b>Group 3: Plastics</b>		
<b>Waste category</b>	<b>Waste description</b>	<b>Hazardous</b>
Category 02	Wastes from agriculture, horticulture, aquaculture, forestry, hunting and fishing, food preparation and processing	
02 01 04	Waste plastics (except packaging)	
Category 12	Wastes from shaping and physical and mechanical surface treatment of metals and plastics	
12 01 05	Plastics shavings and turnings	

Category 15	Waste packaging; absorbents, wiping cloths, filter materials and protective clothing not otherwise specified	
15 01 02	Plastic packaging	
Category 20	Municipal wastes (household waste and similar commercial, industrial and institutional wastes) including separately collected fractions	
<b>Group 4: RDF</b>		
<b>Waste category</b>	<b>Waste description</b>	<b>Hazardous</b>
Category 15	Waste packaging; absorbents, wiping cloths, filter materials and protective clothing not otherwise specified	
15 01 06	Mixed packaging	
Category 19	Wastes from waste management facilities, off-site waste water treatment plants and the preparation of water intended for human consumption and water for industrial use	
19 02 10	Combustible wastes other than those mentioned in 19 02 08 and 19 02 09	
19 12 10	Combustible waste (refuse derived fuel)	
19.12.04	Plastic and rubber	
Category 20	Municipal wastes (household waste and similar commercial, industrial and institutional wastes) including separately collected fractions	
20 03 01	Mixed up waste	
<b>Group 5: Rubber/tyres</b>		
<b>Waste category</b>	<b>Waste description</b>	<b>Hazardous</b>
Category 16	Wastes not otherwise specified in the list	
16 01 03	End-of-life tyres	
16 02 16	Components removed from discarded equipment other than those mentioned in 16 02 15	
<b>Group 6: Industrial sludges (filter cakes, centrifuged, dried, etc.)</b>		
<b>Waste category</b>	<b>Waste description</b>	<b>Hazardous</b>
Category 03	Wastes from wood processing and the production of panels and furniture, pulp, paper and cardboard	
03 03 02	Green liquor sludges (from recovery of cooking liquor)	
Category 04	Wastes from the leather, fur and textile industries	
04 02 19	Sludges from on-site effluent treatment containing dangerous substances	*
04 02 20	Sludges from on-site effluent treatment other than those mentioned in 04 02 19	
Category 05	Wastes from petroleum refining, natural gas purification and pyrolytic treatment of coal	
05 01 09	Sludges from on-site effluent treatment containing dangerous substances	*
05 01 10	Sludges from on-site effluent treatment other than those mentioned in 05 01 09	
Category 06	Wastes from inorganic chemical processes	
06 05	Sludges from on-site effluent treatment	
Category 07	Wastes from organic chemical processes	
07 01 11	Sludges from on-site effluent treatment containing dangerous substances	*
07 01 12	Sludges from on-site effluent treatment other than those mentioned in 07 01 11	
Category 08	Wastes from the manufacture, formulation, supply and use (MFSU) of coatings (paints, varnishes and vitreous enamels), adhesives, sealants and printing inks	
Category 10	Wastes from thermal processes	
Category 11	Wastes from chemical surface treatment and coating of metals and other materials; non-ferrous hydrometallurgy	
Category 12	Wastes from shaping and physical and mechanical surface treatment of metals and plastics	
Category 13	Oil wastes and wastes of liquid fuels (except edible oils, and those in chapters 05, 12 and 19)	

## Annexes

Category 14	Waste <b>organic solvents, refrigerants and propellants</b> (except 07 and 08)	
<b>Group 7: Municipal sewage sludges</b>		
<b>Waste category</b>	<b>Waste description</b>	<b>Hazardous</b>
Category 19	Wastes from waste <b>management facilities, off-site waste water treatment plants and the preparation of water intended for human consumption and water for industrial use</b>	
19 03 07	Solidified wastes other than those mentioned in 19 03 06	
19 02 05	Sludges from physico-chemical treatment containing dangerous substances	*
19 02 06	Sludges from physico-chemical treatment other than those mentioned in 19 02 05	
19 08 05	Sludges from treatment of urban waste water	
<b>Group 8: Animal meal, fats</b>		
<b>Waste category</b>	<b>Waste description</b>	<b>Hazardous</b>
Category 02	<b>Wastes from agriculture, horticulture, aquaculture, forestry, hunting and fishing, food preparation and processing</b>	
02 01 02	<b>Animal-tissue waste</b>	
02 02 02	<b>Animal-tissue waste</b>	
<b>Group 9: Coal/carbon waste</b>		
<b>Waste category</b>	<b>Waste description</b>	<b>Hazardous</b>
Category 05	Wastes from petroleum refining, natural gas purification and pyrolytic treatment of coal	
05 01 09	Sludges from on-site effluent treatment containing dangerous substances	*
05 01 10	Sludges from on-site effluent treatment other than those mentioned in 05 01 09	
05 01 17	Bitumen	
05 06 01	Acid tars	*
05 06 03	Other tars	*
Category 19	Wastes from waste <b>management facilities, off-site waste water treatment plants and the preparation of water intended for human consumption and water for industrial use</b>	
19 01 10	Spent activated carbon from flue-gas treatment	
19 01 17	Pyrolysis wastes containing dangerous substances	*
19 09 04	Spent activated carbon	
<b>Group 10: Agricultural waste</b>		
<b>Waste category</b>	<b>Waste description</b>	<b>Hazardous</b>
Category 02	Wastes from agriculture, horticulture, aquaculture, forestry, hunting and fishing, food preparation and processing	
02 01 03	Plant tissue waste	
02 01 08	Agrochemical waste containing dangerous substances	*
02 01 09	Agrochemical waste <b>other than those mentioned in 02 01 08</b>	
02 01 07	Waste from forestry	
Category 03	Wastes from wood processing and the production of panels and furniture, <b>pulp, paper and cardboard</b>	
03 01 01	Waste bark and cork	
03 03 01	<b>Waste bark and wood</b>	
<b>Group 11: Solid waste fuels (impregnated sawdust)</b>		
<b>Waste category</b>	<b>Waste description</b>	<b>Hazardous</b>
Category 03	Wastes from wood processing and the production of panels and furniture, <b>pulp, paper and cardboard</b>	
03 01 04	<b>Sawdust, shavings, cuttings, wood, particle board and veneer containing dangerous substances</b>	*
Category 19	Wastes from waste <b>management facilities, off-site waste water treatment plants and the preparation of water intended for human consumption and water for industrial use</b>	
19 12 11	Other waste (including mixtures of materials) from mechanical treatment of waste containing dangerous substances	*

<b>Group 12: Solvents and related waste</b>		
<b>Waste category</b>	<b>Waste description</b>	<b>Hazardous</b>
Category 02	Wastes from agriculture, horticulture, aquaculture, forestry, hunting and fishing, food preparation and processing	
02 03 03	Waste from solvent extraction	
Category 07	Wastes from organic chemical processes	
07 01 04	Other organic solvents, washing liquids and mother liquors	*
07 01 08	Other still bottoms and reaction residues	*
07 03 04	Other organic solvents, washing liquids and mother liquors	*
07 03 07	Halogenated still bottoms and reaction residues	*
07 03 08	Other still bottoms and reaction residues	*
07 04 03	Organic halogenated solvents, washing liquids and mother liquors	*
07 04 04	Other organic solvents, washing liquids and mother liquors	*
07 04 07	Halogenated still bottoms and reaction residues	*
07 04 08	Other still bottoms and reaction residues	*
07 05 03	Organic halogenated solvents, washing liquids and mother liquors	*
07 05 04	Other organic solvents, washing liquids and mother liquors	*
07 05 07	Halogenated still bottoms and reaction residues	*
07 05 08	Other still bottoms and reaction residues	*
07 06 03	Organic halogenated solvents, washing liquids and mother liquors	*
07 06 04	Other organic solvents, washing liquids and mother liquors	*
07 06 07	Halogenated still bottoms and reaction residues	*
07 06 08	Other still bottoms and reaction residues	*
07 07 03	Organic halogenated solvents, washing liquids and mother liquors	*
07 07 04	Other organic solvents, washing liquids and mother liquors	*
07 07 07	Halogenated still bottoms and reaction residues	*
07 07 08	Other still bottoms and reaction residues	*
Category 08	Wastes from the manufacture, formulation, supply and use (MFSU) of coatings (paints, varnishes and vitreous enamels), adhesives, sealants and printing inks	
08 01 11	Waste paint and varnish containing organic solvents or other dangerous substances	*
08 01 12	Waste paint and varnish other than those mentioned in 08 01 11	
08 01 21	Waste paint or varnish remover	*
08 03 12	Waste ink containing dangerous substances	*
08 03 13	Waste ink other than those mentioned in 08 03 12	
08 04 09	Waste adhesives and sealants containing organic solvents or other dangerous substances	*
08 05 01	Waste isocyanides	*
Category 09	Wastes from the photographic industry	
09 01 03	Solvent-based developer solutions	*
Category 14	Waste organic solvents, refrigerants and propellants (except 07 and 08)	
14 06 02	Other halogenated solvents and solvent mixtures	*
14 06 03	Other solvents and solvent mixtures	*
Category 19	Wastes from waste management facilities, off-site waste water treatment plants and the preparation of water intended for human consumption and water for industrial use	
19 02 08	Liquid combustible waste containing dangerous substances	*
Category 20	Municipal wastes (household waste and similar commercial, industrial and institutional wastes) including separately collected fractions	
20 01 13	Solvents	*
20 01 27	Paint, inks, adhesives and resins containing dangerous substances	*
20 01 28	Paint, inks, adhesives and resins other than those mentioned in 20 01 27	
<b>Group 13: Oil and oily waste</b>		
<b>Waste category</b>	<b>Waste description</b>	<b>Hazardous</b>
Category 01	Wastes resulting from exploration, mining, quarrying and physical and chemical treatment of minerals	
Category 04	Wastes from the leather, fur and textile industries	

**Annexes**

Category 05	Wastes from petroleum refining, natural gas purification and pyrolytic treatment of coal	
Category 12	Wastes from shaping and <b>physical and mechanical</b> surface treatment of metals and plastics	
Category 13	Oil wastes ( <b>and wastes of liquid fuels</b> except edible oils <b>and those in chapters, 05, 12 and 19)</b>	
13 01 01	<b>Hydraulic oils, containing PCBs</b>	*
13 01 04	Chlorinated emulsions	*
13 01 05	Non-chlorinated emulsions	*
13 02 04	<b>Mineral-based</b> chlorinated engine, gear and lubricating oils	*
13 02 05	<b>Mineral-based</b> non-chlorinated engine, gear and lubricating oils	*
13 02 08	Other engine, gear and lubricating oils	*
13 03 01	Insulating or heat transmission oils containing PCBs	*
13 03 06	<b>Mineral-based</b> chlorinated insulating and heat transmission oils <b>other than those mentioned in 13 03 01</b>	*
13 03 07	<b>Mineral-based</b> non-chlorinated insulating and heat transmission oils	*
13 03 08	Synthetic insulating and heat transmission oils	*
13 04 01	Bilge oils from inland navigation	*
13 04 02	Bilge oils from jetty sewers	*
13 04 03	Bilge oils from other navigation	*
13 05 01	<b>Solids from grit chambers and oil/water separators</b>	*
13 08	Oil waste not otherwise specified	*
<b>Category 16</b>	<b>Wastes not otherwise specified in the list</b>	
<b>16 01 13</b>	<b>Brake fluids</b>	*
<b>Group 14: Others</b>		
<i>Source: [192, CEMBUREAU, 2012].</i>		

**Table 6.1: CEMBUREAU's waste fuel groupings versus those of the EWC**

## 6.2.2 Cement manufacturing – plant specific data

### 6.2.2.1 Examples of types of wastes used, the influence on emissions behaviour and concentration ranges for substances in waste materials (input criteria)

Examples of the types and amounts of wastes used in German cement kilns are shown in Table 6.2. Often these types of wastes include hazardous components.

Type of waste fuel	Quantity used in 2004 (kt/yr)
Tyres/rubber	290
Waste oil	100
Processed fractions of industrial/commercial waste	863
Processed fractions of domestic waste	157
Animal meal and fat	439
Scrap wood	42
Solvents	72
Podsol <sup>(1)</sup>	11
Sewage sludge	48
Others	20
Total	2042
<sup>(1)</sup> bleaching clay	
Source: [76, Germany, 2006]	

**Table 6.2: Types and quantities of waste and waste fuels used in German cement kilns in 2004**

These different types of solid and liquid waste fuels which are used, often also include hazardous components as shown in Table 6.3.

Types of fuel		Quantity (kt/yr)	
		2003	2004
Liquid waste fuel			
Waste oil	Blended waste (hazardous)	116	100
Used solvents	Blended waste, the mono waste which is included has to be declared with a waste code (hazardous)	48	72
Solid waste fuel			
End-of-life tyres	Mono waste	247	290
Wood	Mixed waste, mono waste which is included has to be declared with a waste code (can be hazardous)	48	42
Animal meal	Mono waste	452	439
Sewage sludge	Mono waste	4	48
Bleaching earth	Mono waste (hazardous)	20	11
Production-specific Waste	Mixed waste, the mono waste which is included has to be declared with a waste code	626	862
Separated fractions of Mixed municipal waste	Fuel quality depending on the processing steps used	155	157
Source: [76, Germany, 2006]			

**Table 6.3: Quantities of different types of waste fuels used in the German cement industry**

In 2006, example cement plants in Germany already achieved waste substitution rates of more than 80 %; and up to 100 % of the energy consumption can be utilised by waste fuels. At a dry process kiln system, which consists of a rotary kiln with a four stage, two string preheater and planetary cooler, waste fuels have been used for many years. Mainly tyres, waste oil, wood, treated fractions of industrial waste such as plastics, paper or textiles and solvents are used as fuels. Table 6.4 lists as an example the values accepted for the use of industrial waste and solvents in this plant.

Parameter	Unit	Accepted values in industrial waste	Accepted values in solvents
S	%	2	3 <sup>(1)</sup>
Cl	%	1	1
Cd	mg/kg	10	10 <sup>(2)</sup>
Tl	mg/kg	1	0.5
Hg	mg/kg	0.5	1
Sb	mg/kg	75	5
As	mg/kg	10	20
Pb	mg/kg	100	700 <sup>(3)</sup>
Cr	mg/kg	100	100
Co	mg/kg	20	300
Cu	mg/kg	300	5
Mn	mg/kg	100	1000
Ni	mg/kg	100	10
V	mg/kg	25	0.5
Sn	mg/kg	75	1
<sup>(1)</sup> Yearly average 1 mg/kg <sup>(2)</sup> Yearly average 5 mg/kg <sup>(3)</sup> Yearly average 300 mg/kg Source: [76, Germany, 2006]			

**Table 6.4:** Examples of accepted values of different parameters for the use of industrial waste and solvents

Conditions and the results of the yearly emissions monitoring are shown in Table 6.5 and Table 6.6. During the measurements, waste fuels made up more than 80 % of the energy. Strict emission levels can be achieved.



Parameter	Unit	Number and period of measurements		
		1	2	3
		08:00 – 18:00	08:00 – 18:00	08:00 – 18:00
<b>Fossil fuels</b>				
Main firing (coal dust)	T/h	2.9	3.3	2.4
<b>Waste fuels</b>				
Tyres	T/h	3.4	3.4	3.4
Solvents – line 1	T/h	3.0	3.0	3.0
Solvents – line 2	T/h	3.0	3.0	3.0
Plastics/wood	T/h	6.3	6.3	6.3
<b>Kiln input</b>				
Raw meal	T/h	200	200	200
<b>Calorific values</b>				
Coal	Mj/kg	26.8	26.8	26.8
Tyres	Mj/kg	26.0	26.0	26.0
Solvents – line 1 <sup>(1)</sup>	Mj/kg	27.7	27.7	27.7
Solvents – line 2 <sup>(2)</sup>	Mj/kg	26.6	26.6	26.6
Plastics/wood	Mj/kg	19.0	19.0	19.0
<b>% of energy consumption</b>				
Coal	%	17	19	15
Tyres	%	20	19	20
Solvents – line 1 <sup>(1)</sup>	%	19	18	19
Solvents – line 2 <sup>(2)</sup>	%	18	17	18
Plastics/wood	%	27	28	27
Total of waste fuels	%	83	81	85
Total	%	100	100	100
<b>Product</b>				
Clinker	T/h	121	121	121
Capacity	%	97	97	97

Source: [76, Germany, 2006]

**Table 6.5: Operational data of a German cement kiln using waste fuels (average of the data for a period of three days)**

Component	Unit	Results <sup>(1)</sup>	
		Mill on average	Mill off average
Temperature	°C	106	151
Humidity	Vol-%	17	17
Volume flow	m <sup>3</sup> /h	275 900	2 391 000
Dust	mg/Nm <sup>3</sup>	3 <sup>(2)</sup>	
NO <sub>x</sub>	mg/Nm <sup>3</sup>	385 <sup>(2)</sup>	
SO <sub>x</sub>	mg/Nm <sup>3</sup>	18 <sup>(2)</sup>	
HCl	mg/Nm <sup>3</sup>	n.d. <sup>(3)</sup>	n.d. <sup>(3)</sup>
HF	mg/Nm <sup>3</sup>	0.09 <sup>(4)</sup>	0.06 <sup>(4)</sup>
Hg	mg/Nm <sup>3</sup>	0.009 <sup>(4)</sup> <0.01 <sup>(2)</sup>	0.033 <sup>(3)</sup> <0.002 <sup>(2)</sup>
∑ (Cd, Ti)	mg/Nm <sup>3</sup>	n.d. <sup>(3)</sup>	n.d. <sup>(3)</sup>
∑ (Sb, As, Pb, Cr, Co, Cu, Mn, Ni, V, Sn)	mg/Nm <sup>3</sup>	0.055 <sup>(4)</sup>	0.071 <sup>(4)</sup>
∑ (As, Benzo-a-pyren, Cd, Co, Cr)	mg/Nm <sup>3</sup>	n.d. <sup>(3)</sup>	n.d. <sup>(3)</sup>
TOC	mg/Nm <sup>3</sup>	8	9
PCDD/F	ng I-TEQ/Nm <sup>3</sup>	n.d. <sup>(3)</sup>	n.d. <sup>(3)</sup>
Benzene	mg/Nm <sup>3</sup>	<1 <sup>(4)</sup>	

(<sup>1</sup>) Standard conditions at 1013 hpa and 273 k; after subtraction of water content, and an oxygen content in the flue-gas of 10 vol-%  
(<sup>2</sup>) Yearly average value resulting from continuous measurements  
(<sup>3</sup>) Not detected  
(<sup>4</sup>) Average value for sampling period of 0.5 h  
Source: [76, Germany, 2006]

**Table 6.6: Results from emissions monitoring by using waste fuels in a German cement kiln**

As an example from an Estonian cement plant, the waste fuel used is a homogenous mixture of liquid burnable hazardous wastes and is based on waste oils. If such a mixture meets the technical requirements shown in Table 6.7, the mixture is called waste fuel with a special name and is foreseen only for usage as a supplementary fuel in cement kilns. The waste fuel batch is a fixed volume of liquid waste fuel, processed as one load before delivery to the end user in certain conditions and supplied with a quality specification. Examples of an analysis of characteristics is shown in Table 6.8. Examples of quality requirements of wastes are shown in Table 6.9 below.

Quality data sheet for a waste fuel VA <sup>(1)</sup>				
Nr.	Element	Unit	Limit value; remarks	Measured value
<b>Supplier analyses each batch</b>				
1	Calorific value as received	MJ/kg	>17	
2	Water content as received	mass %	<35; free water in waste is missing at reception	
3	Ash content	mass %	<15	
4	Flashpoint	°C	>60	
5	Solid particles <5mm in VA <sup>(1)</sup> fuel	mm	Missing	
6	Density at 15 °C	kg/Nm <sup>3</sup>	No norms	
7	VA <sup>(1)</sup> viscosity at 40 °C	cSt	Unloading of cargo at reception site is guaranteed without using external means	
8	Reaction test at mixing with oil shale fuses (coagulation, gases, exothermic reaction)		Negative	
<b>Supplier analyses for each 500 Nm<sup>3</sup> VA<sup>(1)</sup> or at least once per year</b>				
8	Sulphur (S)	mass %	<2	
9	Total halogen content Cl+Br+Fl+I	mass %	<1	
10	Metals: Cd+Tl Hg Sb+As+Pb+Cr+Co+Cu+Mn+Ni+V	ppm	<15 <5 <2500	
<b>Supplier analyses for each 2000 Nm<sup>3</sup> waste or at least once per year</b>				
11	PCB <sup>(2)</sup>	ppm	<50	
<sup>(1)</sup> Specially prepared waste fuel VA is a homogeneous mixture of liquid burnable hazardous wastes and is based on waste oils <sup>(2)</sup> Polychlorinated biphenyls Source: [75, Estonia, 2006]				

Table 6.7: Quality data sheet for a waste fuel from Estonia

Analyses of fuses		
Parameter	Unit	Analyses
Higher calorific value	kJ/kg	15072
Lower calorific value	kJ/kg	9211
Solids <sup>(1)</sup>	%	24.3 (100)
Coal <sup>(2)</sup> (C)	%	24.7
Sulphur (S)	%	5.3
Other combustible solids	%	20.6
Ash (non-combustible)	%	49.4
Liquids <sup>(3)</sup>	%	36.6 (100)
Petrol	%	30.3
Oil	%	69.4
Phenols	%	0.3
PCB <sup>(4)</sup>	%	0.5 <sup>(3)</sup>
Water content	%	39.1
Density	kg/l	1.15
Flashpoint	°C	70
<b>Ash (non-combustible), oxidised:</b>		
Chlorine (Cl)	%	traces
Sodium (Na+K)	%	2
Potassium (K)	%	
Calcium (Ca)	%	38.5
Silicon (Si)	%	28.8
Copper (Cu)	%	traces
Magnesia (Mg)	%	6.5
Iron (Fe)	%	6.1
Phosphorus (P)	%	0.2
Aluminium (Al)	%	7.7
Cadmium (Cd)	%	traces
Vanadium (V)	%	traces
Lead (Pb)	%	traces
Zinc (Zn)	%	traces
Chromium (Cr)	%	traces
Nickel (Ni)	%	traces
Sulphur (S)	%	8.7
Titanium (Ti)	%	0.4
Others	%	1.1
<sup>(1)</sup> Dry substances, w = 0 %		<sup>(3)</sup> Organic
<sup>(2)</sup> Carbon		<sup>(4)</sup> Polychlorinated biphenyls
<i>Source: [75, Estonia, 2006]</i>		

**Table 6.8:** Analysis of characteristics from an Estonian cement plant

Quality requirements for the waste		
Parameter	Unit	Requirement
Delivery temperature	°C	90
Viscosity at a temperature of 80 °C	cST <sup>(1)</sup>	5.5 – 6.0
Viscosity at a temperature of 100 °C	cST <sup>(1)</sup>	3.6 – 4.2
Calorific value, lower	MJ/kg	not below 26
Bulk weight	kg/m <sup>3</sup>	1130 – 1140
Flashpoint in an open crucible	°C	not below 130
Melting temperature	°C	up to 50
Ash content	%	up to 0.5
Mechanical additives <sup>(2)</sup>	%	up to 2.0
Water content	%	up to 4.0
Acid value/factor	mg KOH <sup>(3)</sup> /g	up to 260
<b>Chemical composition:</b>		
Sulphur (S)	%	up to 0.2
Chlorine (Cl)	%	up to 0.1
Heavy metals: Na, K, Mn, V, Co, Ni, Cu, Pb, Zn	%	up to 0.005
<sup>(1)</sup> cST = centistokes		<sup>(3)</sup> KOH = potassium hydroxide
<sup>(2)</sup> Grain size not above 3 mm		
Source: [75, Estonia, 2006]		

Table 6.9: Quality requirements for the waste from an Estonian cement plant

Table 6.10 shows the increase of the use of waste and waste fuels in an Estonian cement plant from 2000 to 2005.

Year	Consumption of waste fuels (t/yr)				
	Liquid				Solid
	Oil shale	Waste oil	Benzoic acid material	Total	Oil shale semi-coke
2000	-	365	-	365	-
2001	4415	1223	-	5638	9366
2002	16809	3322	-	20131	10013
2003	16304	4020	-	20324	27503
2004	19921	5643	1500	27064	15300
2005	19242	4552	3312	27106	-
Source: [75, Estonia, 2006]					

Table 6.10: Consumption of waste fuels used in an Estonian cement plant

#### 6.2.2.1.1 Examples of concentration ranges for substances in waste materials/waste input criteria

Table 6.11 to Table 6.13 show examples of typical metal concentration ranges and typical input criteria for different substances of suitable wastes used as fuels and/or raw materials in different cement plants in several countries.

Parameter	Austria <sup>(1,10)</sup>			Switzerland <sup>(2)</sup>		Germany <sup>(3)</sup>	
	Combustible waste <sup>(4,9)</sup> in general	Plastic, paper, textile waste, wood, etc. high calorific fractions from common waste	Solvents, spent oil, waste lacquers	Combustible waste <sup>(5,9)</sup> in general	Other wastes for disposal	Plastic, paper, textile waste, wood, etc. high calorific fractions from common waste <sup>(6)</sup>	Solvents, spent oil
<b>Maximum values (mg/kg)</b>							
As	15	15	20	15	-	13	15
Sb	5	20 (200) <sup>(7)</sup>	100	5	800 <sup>(4)</sup>	120	20
Be	5	-	-	5	-	2	2
Pb	200	500	800	200	500	400	150
Cd	2	27	20	2	5	9	4
Cr	100	300	300	100	500	250	50
Cu	100	500	500	100	600	700	180
Co	20	100	25	20	60	12	25
Ni	100	200	-	100	80	160	30
Hg	0.5	2	2	0.5	5 <sup>(8)</sup>	1.2	1
Tl	3	10	5	3	-	2	2
V	100	-	-	100	-	25	10
Zn	400	-	-	400	-	-	-
Sn	10	70	100	10	-	70	30
Cl (total)	1 %	2 %	-	-	-	1.5 %	-
PCBs	50	-	100	-	-	-	-

(<sup>1</sup>) Voluntary self-commitment from the cement industry with authorities and relevant ministry  
(<sup>2</sup>) BUWAL, co-processing guidelines from Switzerland  
(<sup>3</sup>) Voluntary self-commitment from the waste industry and regulations from the Government North Rhine Westphalia (NRW) Germany  
(<sup>4</sup>) Net calorific value of 25 MJ/kg  
(<sup>5</sup>) Net calorific average value of 18 MJ/kg  
(<sup>6</sup>) Polyethylene terephthalate (PET)  
(<sup>7</sup>) Polyethylene terephthalate (PET), polyester  
(<sup>8</sup>) Special case, flue-gas cleaning for Hg  
(<sup>9</sup>) Other combustible waste in general (not applicable to selected authorised waste streams)  
(<sup>10</sup>) More up-to-date values can be found in the 'Guideline for Waste Fuels' of the Federal Ministry of Austria, notified by the European Commission  
Source: [104, HOLCIM/GTZ, 2006], [168, TWG CLM, 2007]

**Table 6.11: Limit values in different permits and regulations in Austria, Switzerland and Germany for used wastes**

Parameter	Unit	Spain <sup>(1)</sup>	Belgium <sup>(1)</sup>	France <sup>(1)</sup>
Calorific values	MJ/kg	-	-	-
Halogens (expressed as Cl)	%	2	2	2
Cl	%	-	-	-
F	%	0.20		
S	%	3	3	3
Ba	mg/kg	-	-	-
Ag	mg/kg	-	-	-
Hg	mg/kg	10	5	10
Cd	mg/kg	50/100 <sup>(2)</sup>	70	-
Tl	mg/kg	50/100 <sup>(2)</sup>	30	-
∑ Hg+Cd+Tl	mg/kg	100	-	100
Sb	mg/kg	-	200	-
∑ Sb+As+Co+Ni+Pb+Sn+V+Cr	mg/kg	0.50 %	2500	2500
As	mg/kg	-	200	-
Co	mg/kg	-	200	-
Ni	mg/kg	-	1000	-
Cu	mg/kg	-	1000	-
Cr	mg/kg	-	1000	-
V	mg/kg	-	1000	-
Pb	mg/kg	-	1000	-
Sn	mg/kg	-	-	-
Mn	mg/kg	-	2000	-
Be	mg/kg	-	50	-
Se	mg/kg	-	50	-
Te	mg/kg	-	50	-
Zn	mg/kg	-	5000	-
PCBs	mg/kg	30	30	25
PCDD/PCDF	mg/kg	-	-	-
Br+I	mg/kg	-	2000	-
Cyanide	mg/kg	-	100	-
<sup>(1)</sup> Limit values set by authorities for individual permits for cement plants in Spain, Belgium and France				
<sup>(2)</sup> Update Spain 2007				
Source: [104, HOLCIM/GTZ, 2006], [182, TWG CLM, 2008]				

**Table 6.12: Examples of limit values for waste fuels for different countries/regions based on individual permits**

Parameter	Unit	Spain <sup>1</sup>	Belgium <sup>(1)</sup>	France <sup>(1)</sup>	Switzerland <sup>(2)</sup>
TOC	mg/kg	2 %	5000	5000	-
Total halogens (expressed as Cl)	%	0.25	0.5	0.5	-
F	%	0.1	-	-	-
S	%	3	1	1	-
Hg	mg/kg	10	-	-	0.5
Cd	mg/kg	100	-	-	0.8
Tl	mg/kg	100	-	-	1
∑ Hg+Cd+Tl	mg/kg	100	-	-	-
Sb	mg/kg	-	-	-	1
∑ Sb+As+Co+Ni+Pb+Sn+V+Cr	mg/kg	0.50 %	-	-	-
As	mg/kg	-	-	-	20
Co	mg/kg	-	-	-	30
Ni	mg/kg	-	-	-	100
Cu	mg/kg	-	-	-	100
Cr	mg/kg	-	-	-	100
V	mg/kg	-	-	-	200
Pb	mg/kg	-	-	-	50
Sn	mg/kg	-	-	-	50
Mn	mg/kg	-	-	-	-
Be	mg/kg	-	-	-	3
Se	mg/kg	-	-	-	1
Te	mg/kg	-	-	-	-
Zn	mg/kg	-	-	-	400
PCBs	mg/kg	30	-	-	1
pH	mg/kg	-	-	-	-
Br+I	mg/kg	-	-	-	-
Cyanide	mg/kg	-	-	-	-

<sup>(1)</sup> Limit values set by authorities for individual permits for cement plants in Spain, Belgium and France  
<sup>(2)</sup> Limit values for wastes used as raw materials, BUWAL 1998 (Switzerland), Guidelines Disposal of Wastes in Cement Plants  
Source: [104, HOLCIM/GTZ, 2006]

**Table 6.13: Examples of limit values for wastes to be used as raw materials in different countries/regions**

Table 6.14 and Table 6.15 show examples of typical input criteria for substances in wastes used in German cement plants.

Element	Concentration (mg/MJ)
Lead	0.09 – 25
Cadmium	0.01 – 0.7
Chromium	0.09 – 21
Nickel	0.1 – 25
Mercury	0.01 – 0.1
Thallium	<0.01 – 0.1
Zinc	0.5 – 625

Source: [60, VDI 2094 Germany, 2003]

**Table 6.14: Examples of typical concentration ranges of metals from waste fuels**

Parameter	Concentration (mg/kg)
Arsenic	13
Cadmium	9
Cobalt	12
Chromium	250
Copper	700 <sup>(1)</sup>
Mercury	0.5 – 1
Manganese	500
Nickel	100
Lead	400
Antimony	120
Thallium	1 – 2
Vanadium	25
Tin	70

<sup>(1)</sup> Higher values may occur in individual samples  
Source: [76, Germany, 2006]

**Table 6.15: Examples of input criteria for the use of suitable waste applied in German cement kilns**

Table 6.16 and Table 6.17 show permit criteria for different substances for the types of wastes used in Austrian cement plants. In some cases, the selection of types of waste fuels and their input criteria are based on the so-called ‘positive list’, which is a self commitment of the cement industry. Furthermore, in some cases, the local authorities set more stringent input criteria. All permits contain maximum values, some in relation to the calorific value, others in relation to waste fuel types. In addition to the maximum values, one permit also contains median and 80 percentile values, depending on the type of waste fuel. One permit was issued in 2005.

Parameter	Waste fuels except sewage sludge <sup>(3)</sup> (calorific value = 25 MJ/kg)	Paper and sewage sludge	Waste oil, solvents, varnish waste	Plastics, fractions with a high calorific value	Waste wood	Used tyres	Paper	Rubber	Animal meal
<b>Maximum values (mg/kg<sub>dry substance</sub>)</b>									
As	15	5 – 10	10 – 20	15	15	-	0.5	36	0.3
Sb	200	20	10 – 100	20 – 30 (800 <sup>(1)</sup> )	20	-	0.5	8.4	1
Pb	150	100 – 500	250 – 800	500	300 – 800	-	500	33.8	2
Cd	5	3 – 5	1 – 20	25 – 27	10 – 15	-	5	8	0.1
Cr	150	100 – 500	50 – 300	300	70	-	300	97	5
Co	50	50 – 60	3 – 25	20 – 100	14	-	60	128	1
Cu	700	350 – 600	500	500	100 – 400	-	600	748	15
Mn	500	700	70 – 100	-	150	-	300	4250	30
Ni	100	60	40 – 100	200	100	-	80	200	1.5
Hg	0.5	2 – 3	1 – 2	0.86 – 2	1	-	0.6	0.4	0.2
Tl	3	3	1 – 5	3 – 10	2	-	5	1	0.6
V	100	100	10 – 100	70	60	-	15	40	1
Zn	-	1000 – 2000	300 – 3000	-	1000	20000	2000	11400	150
Sn	50	10 – 50	-	70	-	-	10	20	1.5
Cl	1 wt-% <sup>(2)</sup>	0.8 wt-%	1 wt-%	2 wt-%	0.5 wt-%	-	-	-	-
S	3 wt-%	-	-	-	-	-	-	-	-

<sup>(1)</sup> Only for polyethylene terephthalate (PET)  
<sup>(2)</sup> Cl, F  
<sup>(3)</sup> From one permit  
Source: [161, Austria, 2006], [168, TWG CLM, 2007], [170, Austria, 2007]

**Table 6.16: Examples of permit criteria (maximum values) for substances in wastes used in Austrian cement plants**



Parameter	Paper and sewage sludge	Waste oil	Solvents	Plastics	Waste wood	Paper	Rubber	Animal meal
	Median and 80 percentile values (mg/kg <sub>dry substance</sub> )							
	Median	Median	Median	80 perc.	80 perc.	Median	Median	80 perc.
As	3.78	12	6	10	10	0.46	16.4	0.2
Sb	4.97	67	6	20	20	0.37	5.72	0.6
Pb	25.5	59	180	150	150	31.85	28	1.5
Cd	1.02	0.5	0.6	15	5	0.63	3.9	0.05
Cr	28	8	30	150	50	12.2	26	3
Co	6.6	1	1.8	15	10	3.6	80	0.4
Cu	160.5	52	300	300	50	10.75	300	12
Mn	350	0.1	42	200	150	287	28.6	25
Ni	22	1	24	100	100	11.1	77	1
Hg	1.2	0.47	0.6	0.6	0.5	0.26	0.02	0.1
Tl	6.69	0.05	0.6	1.5	1	1.11	0.4	0.3
V	16.05	1	6	30	60	6.11	12	0.5
Zn	40.6	390	30	30	20	1.76	10	1
Sn	877	1000	180	-	-	34.9	8597	120
Cl	-	0.4 wt-%	-	-	-	-	-	-
S	-	2 wt-%	-	-	-	-	-	-
PCB/PCT	-	50	-	-	-	-	-	-
Median value: 50 percentile value				Maximum value: 100 percentile value				
80 perc.: 80 percentile value								
<i>Source:</i> [161, Austria, 2006], [168, TWG CLM, 2007], [170, Austria, 2007]								

**Table 6.17: Examples of permit criteria (median and 80 percentile values) for substances in waste used in Austrian cement plants**

Examples of input criteria for substances in suitable waste used in cement plants in France (minimum and maximum limit values), Spain and Poland are shown in Table 6.18 and Table 6.19.

Parameter	Unit	Maximum value	Minimum value	Comment	
Hg	ppm	<10	<10	( <sup>1</sup> )	
Hg+Cd+Tl	ppm	<1000	<100	( <sup>2</sup> )	
Cr	ppm	<10000	<250	( <sup>3</sup> )	
Cu	%	<2	<1		
Zn	%	<15	<1		
Co	%	<1	-		
Ni	%	<1	-		
Mn	%	<1	-		
Pb	%	<0.6	<0.1		
∑ As+Ni+Co+Se+Te+Cr+Pb+Sb+Sn+V	ppm	<10000	<2500		
∑ As+Ni+Co+Se+Te+Cr+Pb+Sb+Sn+V+Cu	ppm	-	<3500		
∑ Sb+As+Pb+Cr+Co+Cu+Mn+Ni+V+Cd+Tl+Hg	%	-	<1		
∑ As+Ni+Co+Se+Te+Cr+Pb+Sb+Sn+V+Cu+Zn+Mn	%	-	<2		
∑ Cd+Hg+Cr+Pb+Sn+V+Co+As+Cu+Mn+Mo+Tl+Ni	%	-	<1		
Sulphur	%	<12	<0.5		( <sup>4</sup> )
PCB/PCB+PCT( <sup>8</sup> )	ppm	<50	<50		( <sup>5</sup> )
PCP( <sup>9</sup> )	ppm	<50	-		( <sup>6</sup> )
Total chlorine	%	<4	<1	( <sup>7</sup> )	
Other halogens (bromide+iodide+fluoride)	%	-	<0.5	-	
Alkalis (Na <sub>2</sub> O+K <sub>2</sub> O)	%	<15	0.8	( <sup>4</sup> )	
Phosphates (P <sub>2</sub> O <sub>5</sub> )	%	<15	<0.75	( <sup>4</sup> )	

(<sup>1</sup>) A value of 10 ppm is relevant for mercury for all cement plant permits  
(<sup>2</sup>) A large number of cement plant permits have a limit of 100 ppm for volatiles  
(<sup>3</sup>) A case by case situation depending on the local authorities. Three cement plants have no limitations on metals, 10 permits are related to previous EU legislation, some plants received permits with specific lists for metals or specific limitations on specific metals  
(<sup>4</sup>) Large range of acceptance of this parameter  
(<sup>5</sup>) Only one limit on PCB/PCT  
(<sup>6</sup>) Only one limit on PCP  
(<sup>7</sup>) Large range of acceptance on this parameter; more stringent constraints may exist on the waste deliveries depending on each kiln  
(<sup>8</sup>) PCB: polychlorinated biphenyl; PCT: polychlorinated terphenyl  
(<sup>9</sup>) PCP: pentachlorophenol  
Source: [168, TWG CLM, 2007], [174, EUCOPRO, 2007]

**Table 6.18: Examples of input criteria for substances for suitable waste fuels used in cement plants with French permits**

Parameter	Unit	Spain			Poland		
		National law	Plant 1	Plant 2	National law	Plant 1	Plant 2
Hg	ppm	nc	10	-	nc	nc	nc
∑ Hg+Cd+Tl	ppm	nc	100	100	nc	nc	nc
∑ Sb+As+Pb+Cr+Co+Cu+Ni+Mn+V	ppm	nc	5000	10000	nc	nc	nc

nc: no input criteria  
Source: [168, TWG CLM, 2007], [174, EUCOPRO, 2007]

**Table 6.19: Examples of input criteria for substances for suitable waste fuels used in cement plants in Spain and Poland**

Parameter	Unit	Maximum value
Sulphur	% w/w	1.5
Chlorine	% w/w	2.0
Fluorine	% w/w	0.5
Bromine	% w/w	0.5
Iodine	% w/w	0.2
Mercury	ppm	10
∑Cadmium+Thallium (total)	ppm	30
Antimony	ppm	300
Arsenic	ppm	60
Chromium	ppm	200
Cobalt	ppm	100
Copper	ppm	300
Lead	ppm	500
Manganese	ppm	250
Nickel	ppm	500
Tin	ppm	200
Vanadium	ppm	50
Polychlorinated biphenyls (PCBs)	ppm	10
Pentachlorophenol (PCP)	ppm	20
Solids	% w/w	15
Ash	% w/w	10
Water	% w/w	20

Source: [168, TWG CLM, 2007], [174, EUCOPRO, 2007]

**Table 6.20: Input criteria specifications of a waste example**

### 6.2.2.2 Examples of energy consumption

In Austrian cement plants, the consumption of conventional fuels as well as waste fuels used to cover the thermal energy demand, have permanently increased over the years from 1997 to 2004, as shown in Table 6.21.

Fuel	1997 (t/yr)	1998 (t/yr)	1999 (t/yr)	2000 (t/yr)	2001 (t/yr)	2002 (t/yr)	2003 (t/yr)	2004 (t/yr)
Coal	200241	159331	131580	166965	149354	76504	70523	72218
Lignite	7434	4335	11774	35023	38855	62908	69786	62551
Fuel oil	53423	46762	45081	17574	11004	11714	12363	14909
Gas <sup>(1)</sup>	12618	11595	12394	13438	11343	10735	8727	8528
Petcoke	3275	11692	24021	10367	8648	51882	50089	57147
Other fossil fuels	0	0	0	0	0	0	82	1028
Total fossil fuels	273347	233171	221271	239486	215928	210643	209050	213916
Secondary fuels	101063	121719	135065	169888	218048	238959	267822	274032
Total fuels	374411	354890	356336	409374	433976	449602	476872	487948

<sup>(1)</sup> 1000 m<sup>3</sup> (Vn/yr)  
Source: [92, Austria, 2006]

**Table 6.21: Fuel consumption in the Austrian cement industry**

### 6.2.2.3 Examples of emissions data

Emissions data from 2006 from an Estonian cement plant are shown in Table 6.22.

Name and source of pollutant		Permitted data (t/yr)	Actual emissions data 2006 (t/yr)
Total dust		542.98	245.5
Total dust resulting from	Rotary kilns in special regime	420.0	89.84
	Rotary kilns in ordinary regime	149.60	71.11
	Oil shale mills	21.60	8.66
	Clinker coolers	178.60	63.23
	Clinker conveyors	5.76	1.85
	Limestone crushers	5.04	0.86
	Cement mills	7.56	2.25
	Cement mills with a separator	2.52	0.80
	Cement packing machines	1.08	0.44
	Limestone quarry	50.96	2.5
	Landfill for industrial wastes	4.32	1.02
	Oil shale quarry	1.44	0.35
	Port (different materials)	114.50	2.85
SO <sub>2</sub>		5762.70	1696.63
SO <sub>2</sub> resulting from	Rotary kilns	5760.00	1696.63
	Oil shale mills	2.70	-
NO <sub>x</sub> (calculated as NO <sub>2</sub> )		3072.6	576.57
NO <sub>x</sub> resulting from	Rotary kilns	2880.00	534.37
	Oil shale mills	43.2	15.76
	Power station	149.4	26.44
CO		3072.60	510.43
CO resulting from	Rotary kilns	4608.00	460.00
	Oil shale mills	10.8	7.72
	Power station	149.40	42.71
CO <sub>2</sub>		787333	745620
Hydrogen chloride		247.60	5.03
Hydrogen fluoride		12.68	-
VOC		307.44	26.17
Heavy metals		20.32	0.08

Source: [75, Estonia, 2006]

**Table 6.22: Examples of different emissions data from an Estonian cement plant in 2006 compared with permitted emissions data**

Fine dust  $PM_{10}$  and  $PM_{2.5}$ 

Examples of fine dust fractions  $PM_{10}$  and  $PM_{2.5}$  emitted from Irish cement plants are shown in Table 6.23.

Source	PM	Concentrations			Mass emissions rate (kg/h)
		As emitted (mg/Nm <sup>3</sup> )	Corrected to 10 % oxygen (mg/Nm <sup>3</sup> )	Standard conditions (mg/Nm <sup>3</sup> )	
Plant 1 <sup>(6)</sup>	Raw mill (ESP)	$PM_{10}$	2.67 <sup>(1)</sup>	2	0.7684
		$PM_{10}$	2.65 <sup>(1)</sup>	2	0.7237
	Grate cooler (ESP)	$PM_{10}$	7 <sup>(2)</sup>		1.4782
		$PM_{10}$	7 <sup>(2)</sup>		1.6866
	Coal mill (fabric filter)	$PM_{10}$	9.33 <sup>(3)</sup>	9	0.2979
		$PM_{10}$	10.1 <sup>(3)</sup>	10	0.3085
	Cement mill (fabric filter)	$PM_{10}$	107 <sup>(4)</sup>		4.38
		$PM_{10}$	73 <sup>(4)</sup>		3.00
	Separator for cement mill (fabric filter)	$PM_{10}$	3 <sup>(2)</sup>		0.4095
$PM_{10}$		0 <sup>(5)</sup>		0	
Fabric filter exhaust vents	$PM_{10}$		0.007 – 0.302		
Plant 2 <sup>(7)</sup>	Cement mill (fabric filter)	$PM_{10}$		3.33	
		$PM_{2.5}$		<1.1	
	Coal mill (fabric filter)	$PM_{10}$		3.33	
		$PM_{2.5}$		3.33	
	Raw mill and cement mill (ESP)	$PM_{10}$		2.22	
		$PM_{2.5}$		5.56	
	Kiln feed (fabric filter)	$PM_{10}$		1.11	
		$PM_{2.5}$		2.22	
	Clinker conveyor (fabric filter)	$PM_{10}$		1.11	
		$PM_{2.5}$		1.11	
	Fabric filter	$PM_{10}$		1.11 – 7.78	
		$PM_{2.5}$		1.11 – 2.22	
	Cement mill	$PM_{10}$		5.56 – 3.33	
		$PM_{2.5}$		1.11 – 2.22	
	Silos	$PM_{10}$		1.11	
		$PM_{2.5}$		<1.1 – 3.33	
	Coal mill feed conveyor	$PM_{10}$		4.44	
		$PM_{2.5}$		3.33	
Secondary crusher	$PM_{10}$		1.11		
	$PM_{2.5}$		<1.1		
<sup>(1)</sup> 7 % oxygen, temperature 139 °C, average gas flow 280397 Nm <sup>3</sup> /h, 3925 558 Nm <sup>3</sup> /day <sup>(2)</sup> 20.9 % oxygen, temperature 216 °C, average gas flow 225272 Nm <sup>3</sup> /h, 2703269 Nm <sup>3</sup> /day <sup>(3)</sup> 10 % oxygen, temperature 86 °C, average gas flow 31241 Nm <sup>3</sup> /h, 656063 Nm <sup>3</sup> /day <sup>(4)</sup> 20.9 % oxygen, temperature 110 °C, average gas flow 40901 Nm <sup>3</sup> /h, 940739 Nm <sup>3</sup> /day <sup>(5)</sup> 20.9 % oxygen, temperature 86 °C, average gas flow 136940 Nm <sup>3</sup> /h, 2191046 Nm <sup>3</sup> /day <sup>(6)</sup> Measurements from 2001 <sup>(7)</sup> Measurements from 2004 Source: [113, Ireland, 2007], [182, TWG CLM, 2008]					

**Table 6.23: Examples of fine dust emissions  $PM_{10}$  and  $PM_{2.5}$  measured from cement plants in Ireland**

*Emissions to water*

In an example plant in Estonia using the wet process, 602000 m<sup>3</sup> of water was used in 2005 for the mud and oil collector. Emissions to water arise in the technical process for slurry production and from the oil collector. Emissions to water and the amounts of pollutants in waste water from the Estonian cement plant are shown in Table 6.24.

Amount of pollutants in waste water			
Pollutant	Unit	Slurry and oil collector	
		2004	2005
Biological oxygen demand	mg/l	5	7
Suspended solids	mg/l	8.3	11
Nitrogen total	mg/l	1.8	1.4
Phosphorus total	mg/l	0.08	0.057
Sulphates	mg/l	-	
Phenols I basic	µg/l	0.019	<0.5
Phenols II basic	µg/l	0.0053	<0.5
Oil	mg/l	0.03	0.01
Chemical oxygen demand	mg/l	54	-

*Source:* [75, Estonia, 2006]

**Table 6.24:** Amounts of pollutants in waste water in from an Estonian cement plant

## 6.2.3 Cement manufacturing – cogeneration/recovery of excess heat

### 6.2.3.1 Cogeneration of electric power via the conventional steam cycle process – Slite cement plant in Sweden

The cement plant (two kilns) at Slite (Island of Gotland/Sweden), which was initially designed for 6000 t/d clinker production, has continuously increased its production which now totals 7000 t/d. The suspended cyclone preheater tower has an off-gas temperature of approx. 440 °C. Furthermore, the plant has favourably low raw material moisture of between 2 – 3 %. Only a part of the heat from the kiln is needed for dry grinding.

The recoverable heat is sent to an existing electricity plant situated adjacent to the cement works, operated by a third party who re-utilises a steam turbine to generate electricity. The steam is generated in a two step heat recovery boiler system, one at the clinker cooler and one in the down duct of the kiln. With the installation as shown in Figure 6.1, the plant is able to supply water steam of a sufficient quality:

- clinker cooler with exhaust gas as a waste heat source (approx. 330 °C)
- electric precipitator on the clinker cooler of gas stream
- waste heat boilers – on the clinker cooler – with the water steam circuit
- second waste heat boiler in the off-gas of the preheater tower as a high dust application
- turbine and generator, in which the power is generated
- seawater operated condenser for re-cooling of the water steam.

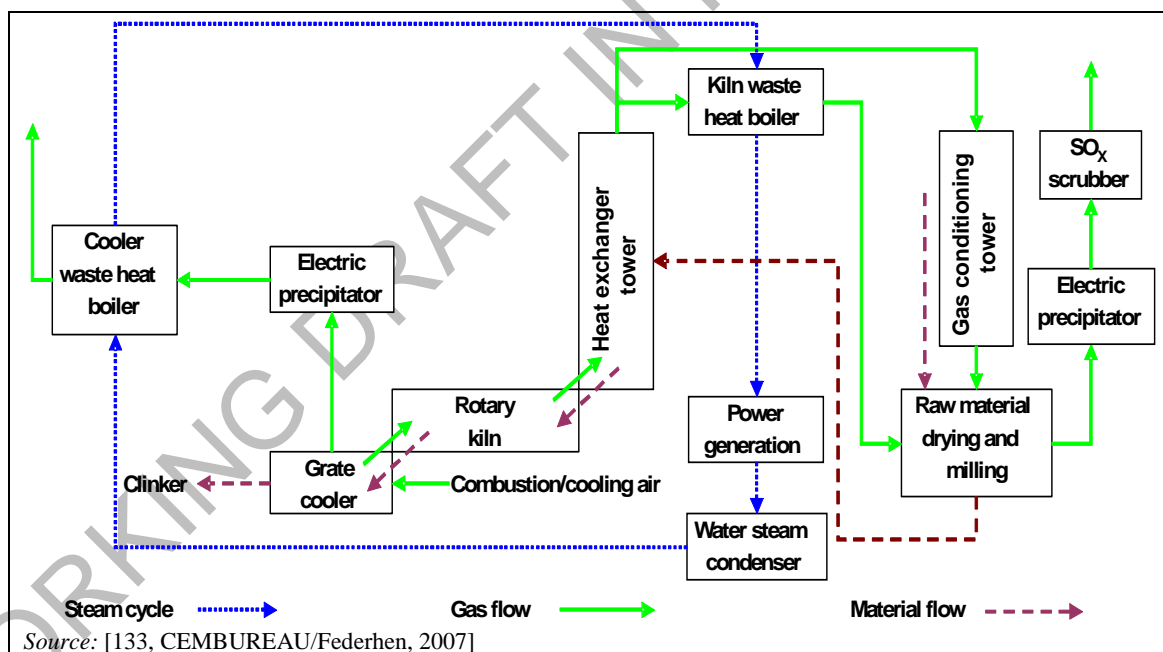


Figure 6.1: Flow diagram of a two step water-based heat recovery system for power cogeneration at the Slite cement plant in Sweden

As the first step, clinker cooler waste heat boilers operate to expectations. However, the preheater off-gas boiler does not generate the steam it was originally designed for – even after modifications. This failure can be seen as a result of the insulating fine dust layer on the heat exchanger tubes. In order to overcome the boiler inefficiency, a more effective dust blower system is needed. An internal survey showed that conventional tube cleaning technique with steam is not economic. Instead, a waste heat boiler with extensive heat exchanger surfaces is needed. This option, however, would generate a much higher pressure drop and increase internal power demand.

In 2007, the plant took approx. 30 MW of heat out of the system; it was initially designed for 9 MW and now supplies, after optimisation, about 6 MW. The investment costs, calculated in 1999, were 8 x EUR 106 for the boiler and steam distribution system, of which 25 % was subsidised. However, no costs were stated for the re-used existing steam turbine which contributed significantly to the economics of the installation. The annual electricity production is now approx. 50 GWh equalling  $\frac{1}{4}$  of the plants total power need.

### **6.2.3.2 Cogeneration with the Organic Rankine Cycle (ORC) process – cement plant in Lengfurt in Germany**

The Lengfurt plant uses the so-called low temperature Organic Rankine Cycle (ORC) process. This process is essentially based on the use of an organic motive medium (pentane) which evaporates at significantly lower temperatures than water instead of using steam as the motive medium. The basic principles of this technique have been used successfully for a long time in refrigeration techniques. The ORC technique is used mainly for generating power from geothermal heat sources; however, the use of this process in a cement plant is a world first. Figure 6.2 shows the flow diagram of this process.

The ORC process for generating power from low temperature waste heat in the cement plant of Lengfurt could in 2007, after seven years of experience, be regarded as a technically feasible alternative to power generating plants using water steam and, due to regional government funding, economic for the owner.

Its particular advantage lies in the stable and robust operation, the compact structure and the relatively high level of efficiency which can be achieved with heat sources of below 275 °C. However, the process is not typical for cement plants and the operation and maintenance personnel need special training.

The ORC waste heat power generating plant itself consists essentially of several sub-systems:

- a clinker cooler with exhaust gas as a waste heat source
- an ESP to reduce the dust emissions:
  - note: fabric filters are not suitable for the temperature level in such an arrangement
- a waste heat boiler with the pentane circuit
- a turbine and a generator, in which the power is generated
- an air condenser plant for re-cooling the pentane circuit.



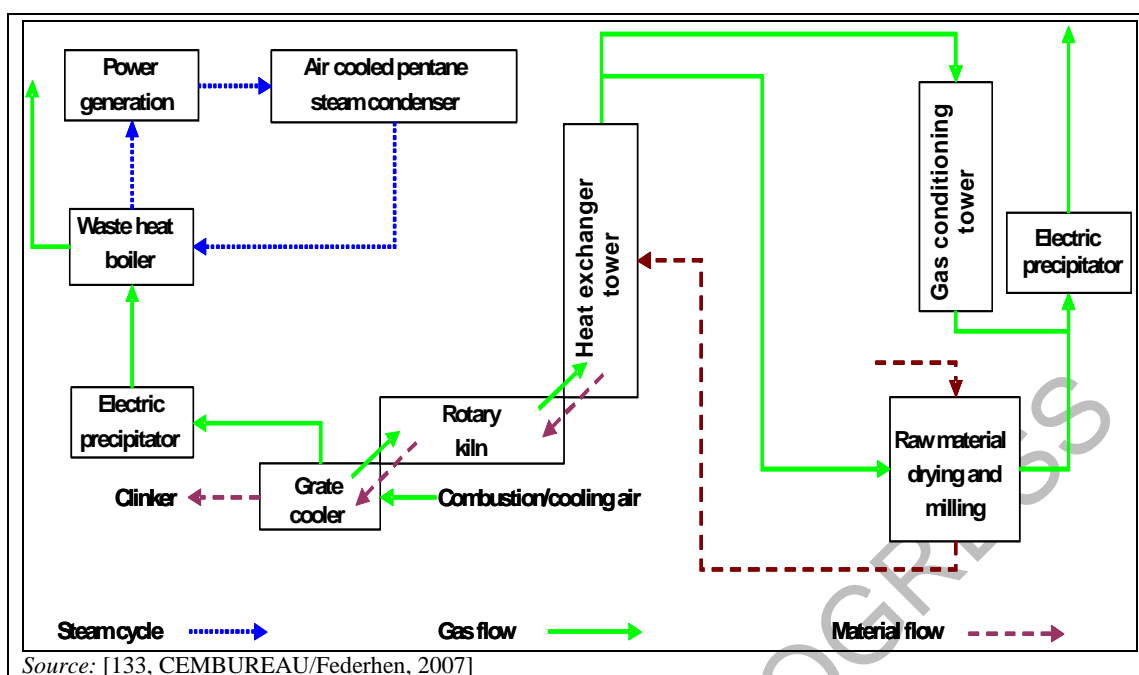


Figure 6.2: Flow diagram of a pentane based waste heat recovery system for power cogeneration at the Lengfurt plant in Germany

The results have shown that 1.0 MW (net.) electrical power can be generated with the given mode of operation. The achieved availability was 97 % of the operation time of the cement kiln. The clinker cooler has a waste heat output via the clinker cooler exhaust air of 14 MW and an exhaust gas temperature of between 300 – 350 °C of which approx. 9 MW on average is extracted.

At times, due to certain operating conditions of the kiln and kiln grate clinker cooler, the output of the turbine is lower than initially designed for. In 2007, the waste heat power generating plant covered up to 9 %; however, in future this plant will make it possible to cover up to 12 % of the electrical power requirement necessary for a cement plant. In this way, CO<sub>2</sub> emissions from the combustion associated with the generation of power can be reduced by between approx. 3000 to 7620 t/yr.

The total capital costs were EUR 4 million. From these total costs, EUR 2 million were accounted for by the ORC plant with a pentane cooling circuit including installation costs. The rest was used by the waste heat boiler, heat transfer plant, solid construction, electrics, design engineering, commissioning, remaining devices and fees. This resulted in specific capital costs of approx. EUR 4000/kW (net.), or EUR 1300/t CO<sub>2</sub> per year. The electric power generated was about 6000 MWh/yr, as the operation costs were EUR 50000 per year. However, no reserves for major repairs were included in the operation costs, which will be a requirement once the plant gets older [78, E. Baatz + G. Heidt, 2000], [79, Germany, 2001], [133, CEMBUREAU/Federhen, 2007].

#### 6.2.4 Cement manufacturing – examples of NO<sub>x</sub> reduction by using a high efficiency SNCR technique

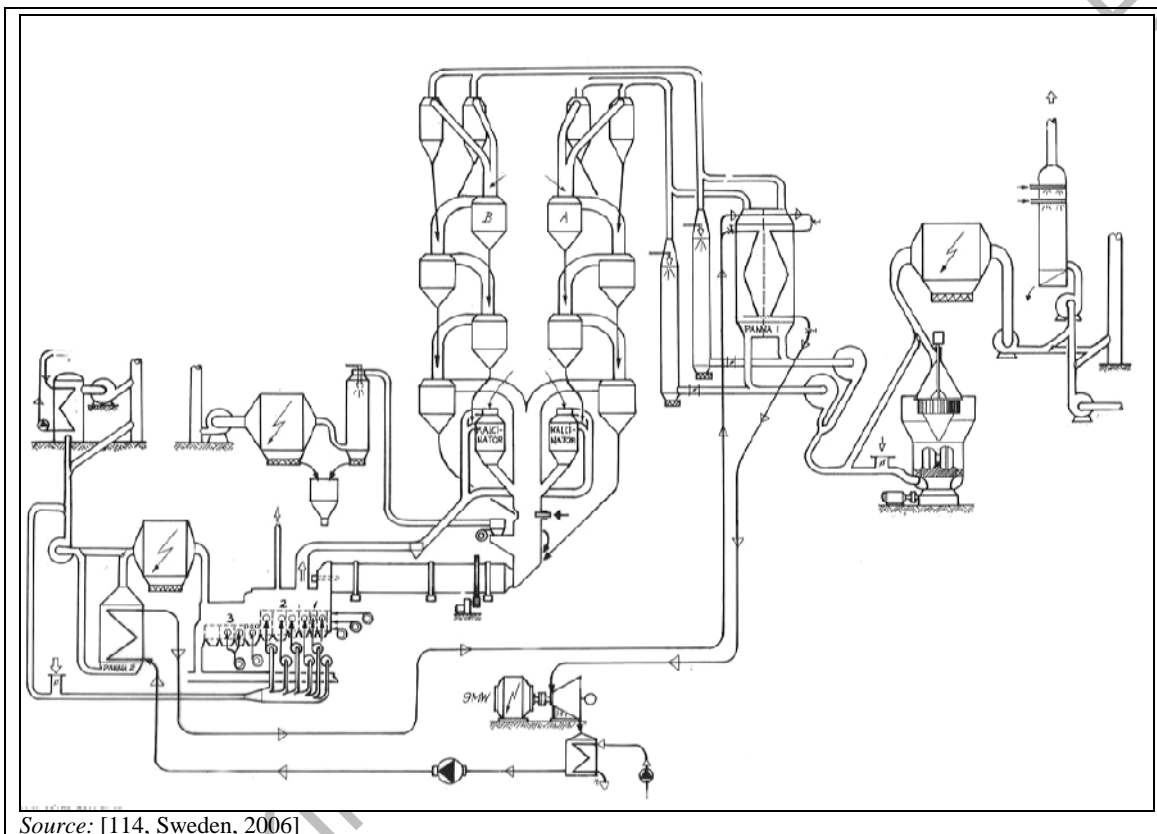
The application of the SNCR technique at cement kilns has a history of more than 25 years. The first operational trials showed the principal applicability of SNCR at rotary cement kilns, provided that a temperature window of between 900 and 1000 °C was given. In the 1990s, the tests were extended to numerous cement kilns in different countries (Germany, US, Austria, Sweden, Switzerland, etc.). In most cases, NO<sub>x</sub> reduction rates of more than 50 % could be

achieved. Now, SNCR is used in the cement industry for reducing  $\text{NO}_x$  and is successfully applied at numerous cement kilns in Europe and the US.

#### 6.2.4.1 Example SNCR technique used in Sweden

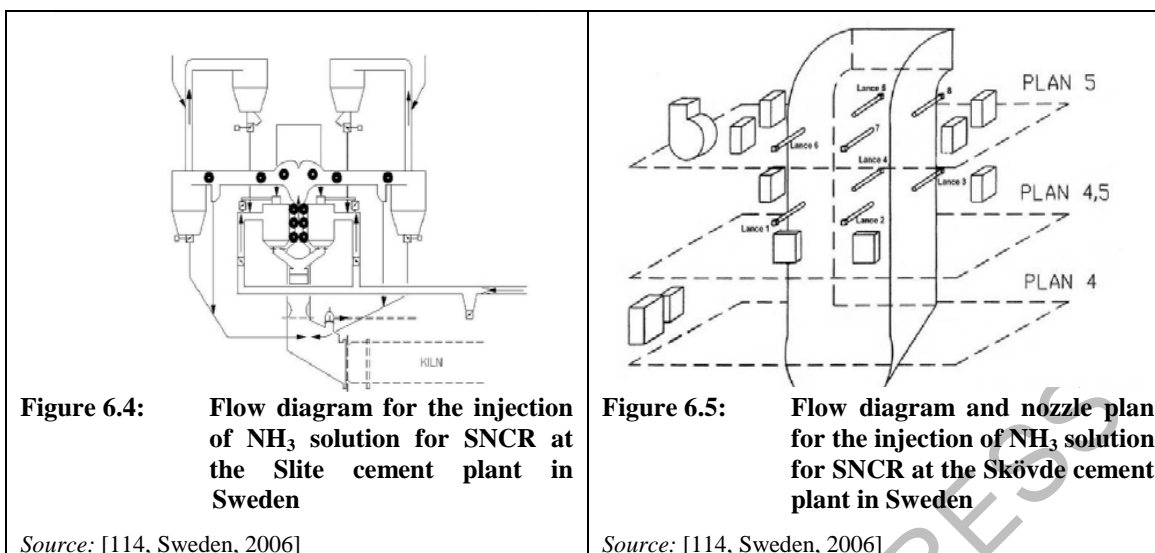
##### Process

In Sweden, Cemeta AB has been operating high efficiency SNCR for  $\text{NO}_x$  reduction since 1997 on three cement kilns with a kiln capacity of 1900 t/d (five stage preheater kilns with satellite cooler) at their Skövde cement plant and kiln capacities of 1200 and 5800 t/d at their Slite cement plant. Figure 6.3 shows the flow diagram from a preheater kiln with satellite cooler in Slite.

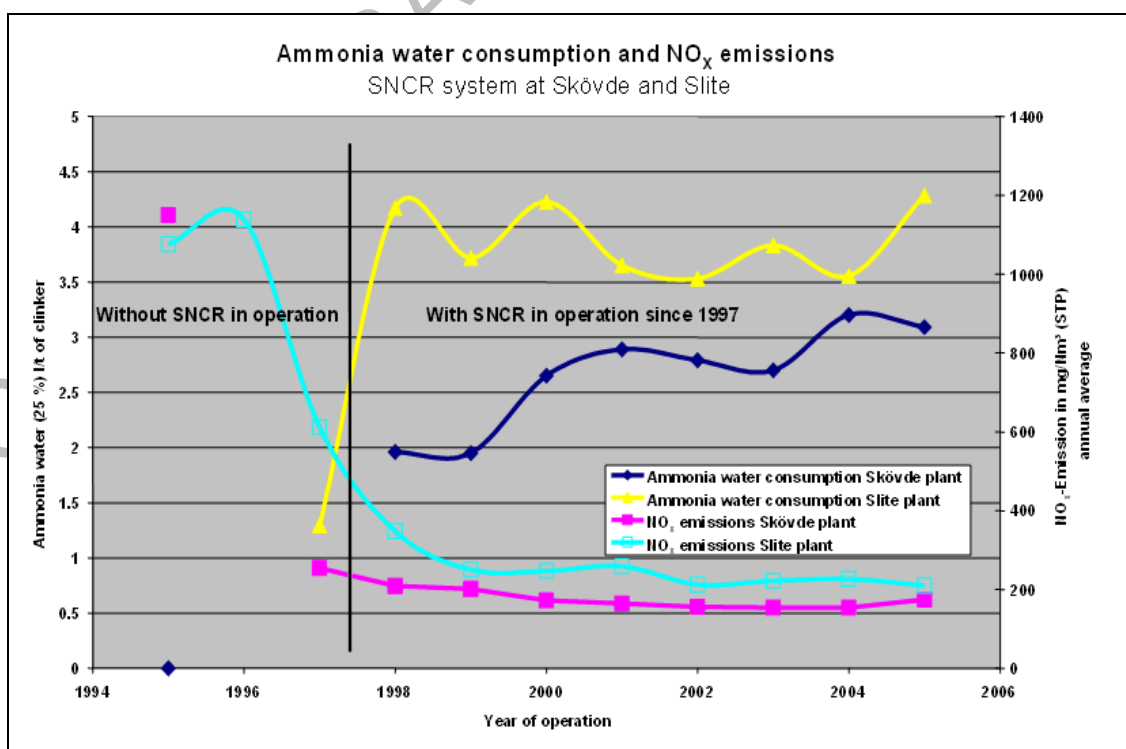


**Figure 6.3:** Flow diagram of the cement manufacturing process in Slite (Sweden)

For the injection of ammonia to the gas stream, a different number of pairs of nozzles are used. Slite cement plant normally uses three to four pairs of nozzles as shown in Figure 6.4, while the schematic view of the distribution of nozzles for the injection of ammonia solution at Skövde is shown in Figure 6.5.



At both plants the initial  $\text{NO}_x$  level was between 800 to 1100  $\text{mg}/\text{Nm}^3$  thus the reduction rate remained around 80 % as initially found. Since 1998, the long term  $\text{NO}_x$  emissions that have been achieved have been around 200  $\text{mg}/\text{Nm}^3$ , but at the Skövde plant less than 200  $\text{mg}/\text{Nm}^3$ , measured as yearly averages. Since 1997, about 63500 t ammonia have been consumed in order to abate approximately 45000 t  $\text{NO}_x$ . At the Slite cement plant, the ammonia water consumption (25 %) stabilised at around 3.5 to 4.5 l/t clinker produced. At Skövde cement plant, it swayed between 2.5 and 3.5 l/t. Figure 6.6 shows the ammonia water consumption and the  $\text{NO}_x$  emissions that were achieved at these plants from 1995 until 2005. The effect of the fluctuating ammonia consumption is most likely due to a change in the clinker sintering conditions and, to a lesser extent, also to the wear of the nozzles in the system. Remarkably, it was not necessary to change the nozzles between 1997 and 2005, and the downtime for the three kilns was less than 200 h.



**Figure 6.6:**  $\text{NO}_x$  emissions and the consumption of ammonia water at the cement plants in Slite and Skövde in Sweden from 1995 until 2005

### *Molar ratio*

In 2001, the initial molar ratio was found to be 1 – 1.2 (mol NH<sub>3</sub> to present mol of NO<sub>x</sub>) at the Skövde plant. With an average removal efficiency of 80 %, these are computed to be 1.2 to 1.4 for the removed NO<sub>x</sub>. At the Slite plant, the ammonia ratio was as initially found to be once again in the region of 1.2 – 1.4 mol/mol (present NO<sub>x</sub> to injected NH<sub>3</sub>) or 1.5 – 1.8 (reduced NO<sub>x</sub> to injected NH<sub>3</sub>).

### *Ammonia slip*

From 1994 to 1996, tests of ammonia slip and emissions showed that both plants had natural ammonia emissions arising from the raw material of 10 to 30 mg/Nm<sup>3</sup> at the Skövde plant and 15 to 20 mg/Nm<sup>3</sup> at the Slite plant.

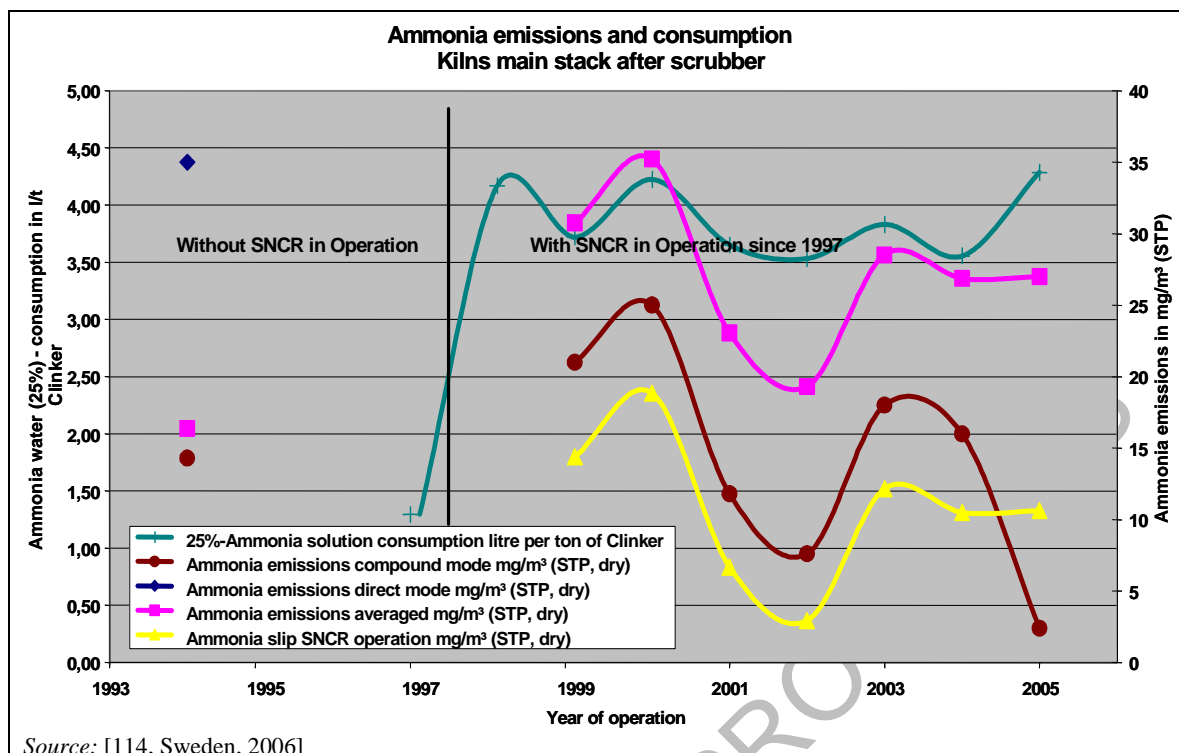
In Skövde, the ammonia slip, once the SNCR was set in operation, was 5 – 10 mg/Nm<sup>3</sup>. In Slite, the ammonia slip on top of the natural emissions was approx. 5 to 20 mg/Nm<sup>3</sup>.

In 2003 at the Skövde plant, repeated measurements showed less than 5 mg/Nm<sup>3</sup> ammonia emissions without using SNCR and 20 mg/Nm<sup>3</sup> by using SNCR.

Significant for both plants is that raw mills were being used. Ammonia was collected within these milling systems. In Skövde, during almost 98 % of the period of operation, the milling systems (raw and coal mills) were in operation. Therefore, the ammonia emissions found there in compound mode (mill operation/mill off) represented the average data.

In contrast, at the Slite cement plant there is a SO<sub>x</sub> scrubber where the ammonia in the scrubber liquor is buffered, hence this equalises peaks and troughs. Together with the gypsum product, only a small fraction of ammonia is taken to the cement milling facilities (3 kg/h). The cement mill operates at low temperatures in a closed circuit and only very occasionally was an ammonia smell detected in the cement silo. Furthermore since 1998, continuous measurements of ammonia emissions were located at the stack of the scrubber. Measured data of ammonia emissions and the consumption of ammonia water at the Slite plant are shown in Figure 6.7. During the operation period without the SO<sub>2</sub> scrubber, the ammonia emissions were between 15 and 35 mg/Nm<sup>3</sup>.

Since the scrubber has been in operation, short time peaks are higher, even up to 125 mg/Nm<sup>3</sup>. This is because the scrubber liquor now increases its temperature from 53 to 59 °C, the equilibrium is shifted and some accumulated ammonia is released again. By using the scrubber at the Slite plant, the averaged ammonia level of 20 – 35 mg/Nm<sup>3</sup> mostly follows the ammonia water consumption trend. This effect shows that the emphasis should remain – despite the high efficiency of the SNCR systems – also on primary NO<sub>x</sub> control through to optimised process combustion conditions.



**Figure 6.7:**  $\text{NH}_3$  emissions and ammonia water consumption at two cement kilns at the Slite cement plant in Sweden from 1994 until 2005

At the Swedish cement plants, special equipment was applied. By using this equipment and an operation of low  $\text{NO}_x$  emissions design, additional ammonia emissions were at a level of 5 – 20  $\text{mg}/\text{Nm}^3$ . However, the ammonia slip does fluctuate to the nature of the cement manufacturing process.

#### *Costs of operation*

The cost of operating an SNCR system is predominantly dependent on the consumption of ammonia water. Only little pumping energy is needed and the combustion of ammonia in the reduction zone of 900 – 1100 °C compensates for the heat needed to evaporate the water (ammonia carrier).

With costs of approx. EUR 100 per tonne of 25 % ammonia water in 1996 and EUR 130 per tonne in 2006, the reduction costs per tonne clinker produced, rose in Skövde modestly from initially EUR 0.30 to 0.35. Accumulated costs were here then EUR 0.40 to 0.45 per tonne clinker.

In Slite, since the transport costs to the Island of Gotland are higher than on the mainland (in 2007 the cost was EUR 140 per tonne), the cost fluctuated around EUR 0.40 to 0.50 per tonne clinker. In the production cost, electricity, maintenance and depreciation are accumulated to an additional EUR 0.10 per tonne clinker. As initially calculated, the total costs per tonne clinker remained at around EUR 0.50 to 0.60 per tonne clinker.

In the period of 1997 to 2005, the reduction costs added up to approx. EUR 11 million. At the same time, about 45000 t  $\text{NO}_x$  was abated. The total costs with depreciation, capital costs, energy costs and costs for ammonia related to the  $\text{NO}_x$  abated were EUR 250 per tonne  $\text{NO}_x$ .

### 6.2.4.2 Example SNCR technique used in Germany

In an example cement plant in Germany, using a modern dry process kiln system, the SNCR process has been used for many years. This plant uses a rotary kiln of 5.5 m diameter and 89 m length, with a four stage two-string preheater and a planetary cooler. The capacity is about 3000 t/d clinker. The kiln can be fired 100 % of the time with waste fuels. A suitable temperature window is given in the riser duct region to apply the SNCR process. The initial  $\text{NO}_x$  emission level is quite low at approximately 400 – 600  $\text{mg}/\text{Nm}^3$ , on a daily basis. However, it can also be up to 1200  $\text{mg}/\text{Nm}^3$  or more.

The ammonia water (25 % ammonia solution) is stored in a tank with a volume of 100  $\text{m}^3$ . From there, the ammonia water is pumped to a smaller container and the injection of ammonia water, controlled by a suitable device, takes place over eight lances as shown in Figure 6.8. The arrangement of the lances is determined by the temperature profile in the riser duct.



Source: [76, Germany, 2006]

**Figure 6.8:** High efficiency SNCR and place for injection of ammonia water via lances at places Nr. 21 to 26

By using a high efficiency SNCR process, an emission level of 500  $\text{mg NO}_2/\text{Nm}^3$  could constantly be achieved without any significant ammonia slip. Trials were performed to investigate the optimisation of the SNCR plant in order to achieve  $\text{NO}_x$  emissions of below 500  $\text{mg}/\text{Nm}^3$ . In 2007, the latest results from a six months performance test showed that  $\text{NO}_x$  emission values of 350  $\text{mg}/\text{Nm}^3$  (daily average values) were achieved by applying a  $\text{NH}_3:\text{NO}$  molar ratio of 0.7 (interconnected operation/mill on) – 0.8 (direct operation/mill off). Furthermore,  $\text{NO}_x$  emission values of 200  $\text{mg}/\text{Nm}^3$  (daily average values) were achieved by applying a  $\text{NH}_3:\text{NO}$  molar ratio of 1.4 (interconnected operation/mill on) – 1.5 (direct operation/mill off). However, by applying high  $\text{NH}_3:\text{NO}$  molar ratios, ammonia emissions have to be carefully considered. During the performance tests, the  $\text{NH}_3$  emissions were measured continuously. The  $\text{NH}_3$  measurements however resulted in significant ammonia slip by keeping 200  $\text{NO}_x$   $\text{mg}/\text{Nm}^3$  particularly during mill-off operation (max. 50 – 200  $\text{mg}/\text{Nm}^3$ ). Altogether, the ammonia slip was twice as high to achieve the emission level of 200  $\text{mg}/\text{Nm}^3$  ( $\text{NH}_3$ : three months average value of 11  $\text{mg}/\text{Nm}^3$ ) compared to a level of 350  $\text{mg}/\text{Nm}^3$  ( $\text{NH}_3$ : three months average value of 21  $\text{mg}/\text{Nm}^3$ ). The mill off operation ratio in this case was about 10 – 20 %. A relevant enrichment of ammonia in the raw meal and the ESP dust could not be observed during

the performance test. The tests showed that ammonia emissions should carefully be considered. The ammonia slip, which occurs because of the above process, sets the limits to the over-stoichiometric addition of reducing agents [76, Germany, 2006], [168, TWG CLM, 2007], [173, Germany, 2007], [182, TWG CLM, 2008].

### 6.2.5 Cement manufacturing – example of NO<sub>x</sub> reduction by using the SCR technique

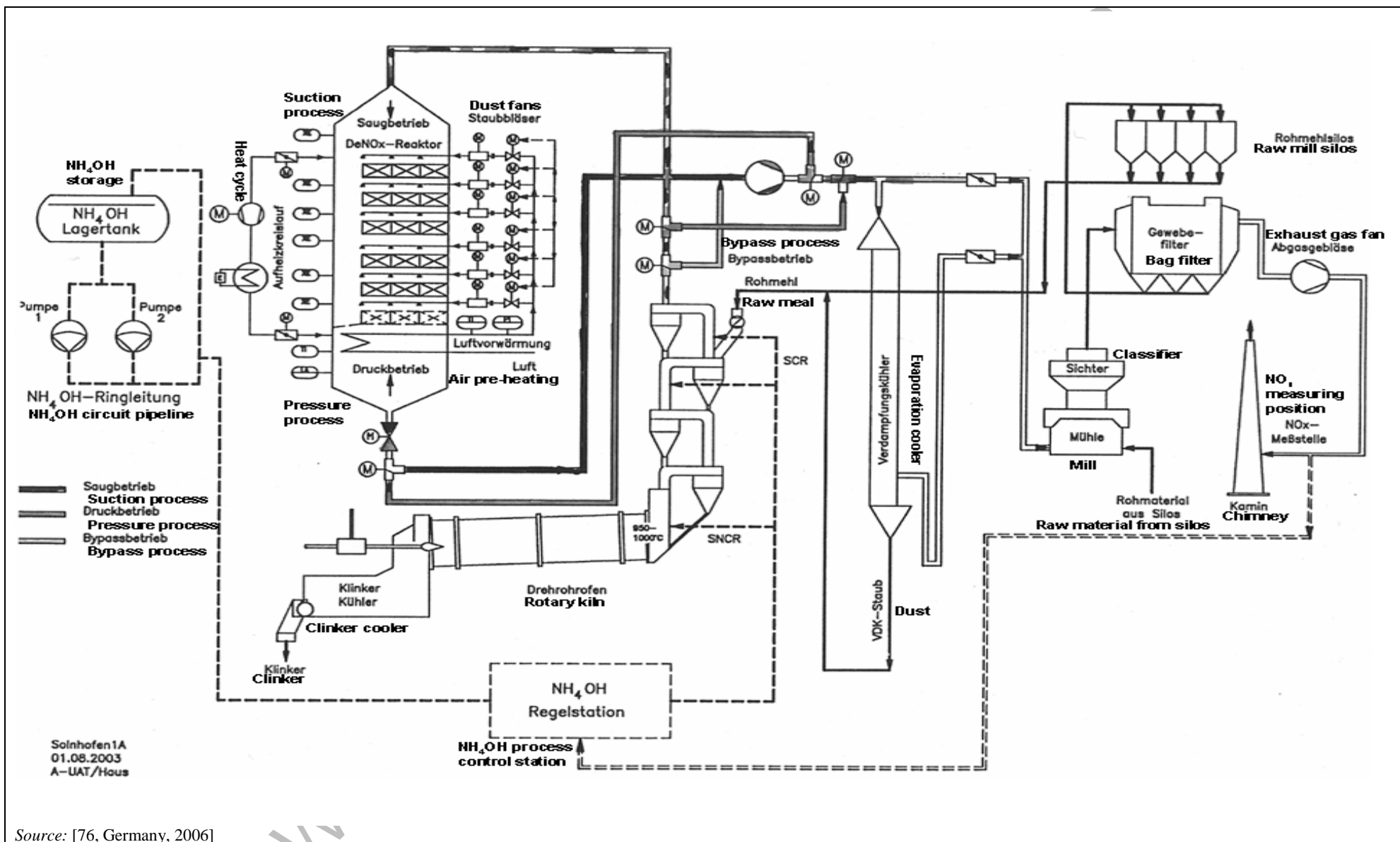
#### Description

The first full scale SCR demonstration plant was built in Germany with government funding. This plant (Solnhofer Portland-Zementwerke) has been in operation since 2001. Solnhofer Portland-Zementwerke decided to implement a high dust SCR system for the following reasons:

- lower consumption of NH<sub>3</sub> compared to SNCR, resulting in lower operational costs
- at the top of the four stage preheater, the waste gas has a temperature of 320 – 350 °C which is suitable for SCR and does not require reheating (as in the case of configuration between the fabric filter and the stack), thus reducing energy costs and pressure loss.

The SCR reactor in Solnhofen allows the installation of six layers of catalytic elements, but only three of these layers have been in use. Each layer consists of six modules, each with 72 catalytic elements. The catalytic elements have a size of 15 x 15 x 90 cm each, a comblike structure and a special composition based on TiO<sub>2</sub> and V<sub>2</sub>O<sub>5</sub>. A pitch of 13 mm (but 10 mm in the middle layer) was chosen in order to avoid plugging. The integrated dedusting system uses preheated, high pressurised air to remove dust accumulations from the catalyst surface. The air nozzles are moved continuously over each catalyst layer, thus no service interruption is necessary to remove dust from the catalyst. By optimisation of the dedusting system, the consumption of high pressurised air was reduced from initially 100 to 18 m<sup>3</sup> per tonne of cement clinker, resulting in energy costs for the operation of the catalyst of about EUR 0.098 per tonne cement clinker [76, Germany, 2006].

The SCR process from the Solnhofen SCR example plant is shown in Figure 6.9.



Source: [76, Germany, 2006]

Figure 6.9: Flow diagram of the SCR example plant in Germany (Solnhofen Portland-Zementwerke)



In order to ensure a maximum lifetime of the SCR reactor, it was designed to facilitate either upstream or downstream operation, as shown in Figure 6.9. Accordingly, the integrated dedusting system is able to blow away dust accumulations either from the upper or the lower surface of each catalyst layer. As long-term experience in Solnhofen did not prove expected advantages for upstream operation, there was no need to switch the gas flow direction. Accordingly, future implementations of high dust SCR could be designed for downstream operation only, thus reducing investment costs.

The reduction agent, a water solution with 25 %  $\text{NH}_3$ , is added to the off-gas at the upper stages of the preheater in a molar ratio of 0.8 to 0.9 to the stoichiometric demand, according to the waste gas flow, the initial  $\text{NO}_x$  concentration and the target value.

The first set of catalysts was in operation for 40000 h without excessive use or loss of activity. Later trials with plate-type catalysts showed higher mechanical use and unexpected losses of activity. In order to ensure full-time emission limit value (ELV) compliance, the Solnhofen plant was equipped with an SNCR system for backup operation in 2006.

#### **Achieved environmental benefits and operational data**

The  $\text{NO}_x$  abatement efficiency of the SCR plant in Solnhofen is usually in the range of 59 to 67 %. Under unusual operating conditions with raw gas concentrations of  $3000 \text{ mg/Nm}^3$  and higher,  $\text{NO}_x$  abatement efficiencies of more than 80 % were observed. In regular operation, the SCR reduces  $\text{NO}_x$  emissions from raw gas concentrations of  $1000$  to  $1600 \text{ mg/Nm}^3$  to about  $400$  to  $550 \text{ mg/Nm}^3$ . It has to be noted that the Solnhofen plant was designed to comply with a  $\text{NO}_x$  emission limit value of  $500 \text{ mg/Nm}^3$  and that it has been operated accordingly, but sometimes the emission limit value of  $500 \text{ mg/Nm}^3$  was exceeded.

With a molar ratio of 0.8 to 0.9, the consumption of  $\text{NH}_3$  is significantly lower than by the application of SNCR. It has to be noted that  $\text{NH}_3$  from the raw material also serves as the reduction agent in the reactor, thus the emission level of residual  $\text{NH}_3$  is very low. At the Solnhofen plant, the SCR usually led to  $\text{NH}_3$  emissions of below  $1 \text{ mg/Nm}^3$ .

In one campaign, the  $\text{NH}_3$  dosage was increased according to a target  $\text{NO}_x$  level of  $200 \text{ mg/Nm}^3$ . In this campaign, an emission level of around  $300 \text{ mg/Nm}^3$  was achieved. These results may indicate the potential of the technique, especially as they were also achieved with three catalytic layers only, and the emission level of residual  $\text{NH}_3$  was still around  $1 \text{ mg/Nm}^3$ .

#### **Cross-media effect**

The only negative cross-media effect is a minor increase of electrical energy demand due to the internal dedusting system of the SCR reactor and additional pressure losses.

#### **Applicability**

Up until 2008, SCR has only been tested on preheater and semi-dry (Lepol) kiln systems, but it might be applicable to other kiln systems as well.

#### **Economics**

The total investment costs of the SCR project in Solnhofen were about EUR 3.5 million, including extra expenditure for development reasons such as the capacity for the six catalyst layers and the ability to operate either in upstream or in downstream mode. The investment costs of a new plant based on the Solnhofen experience are estimated to be approximately EUR 2.2 million for the SCR reactor, including approximately EUR 250000 for the catalysts which have to be calculated with replacement costs each 5 – 6 years. This amount does not include costs for ammonia storage and ductwork, as they vary significantly from site to site. The costs for  $\text{NO}_x$  reduction by SCR or by SNCR are estimated by the German federal environmental agency (UBA) for a kiln capacity of 1500 t/d and a  $\text{NO}_x$  reduction from  $1000$  to  $500 \text{ mg/Nm}^3$  based on practical experience from the Solnhofen plant. As shown in the last two columns of Table 6.26, the cost estimations are extrapolated for a  $\text{NO}_x$  reduction to  $200 \text{ mg/Nm}^3$ .

As a result of the German UBA calculations, the operating costs for SNCR and SCR – including replacement costs for the catalyst – are roughly the same for a target NO<sub>x</sub> level of 500 mg/Nm<sup>3</sup>, while the total specific costs for SCR are approximately 50 % higher than for SNCR. At a target NO<sub>x</sub> level of 200 mg/Nm<sup>3</sup>, SCR seems to be more efficient regarding operating costs, but the total specific costs are still at the same level of magnitude as for SNCR. When comparing these figures, it has to be noted that long-term experience with a NO<sub>x</sub> level of 200 mg/Nm<sup>3</sup> is neither available for SCR nor for SNCR yet. In the case of SNCR, higher emissions of NH<sub>3</sub> also have to be taken into account [76, Germany, 2006]

Basic parameter	Unit	Factor
Clinker production rate	t/yr	480000
Clinker production rate	t/d	1500
Operation time	h/yr	7680
Waste gas flow	Nm <sup>3</sup> /t	2300
Initial NO <sub>x</sub> level	mg/Nm <sup>3</sup>	1000
Initial NO <sub>x</sub> level	kg/t	2.3
NH <sub>3</sub> costs (25 % solution)	EUR/t	90.00
Catalysts costs	EUR/Nm <sup>3</sup>	7500
Useful life of catalyst	h	40000
Useful life of investments	yr	20
Inflation rate	%	3.0

Source: [76, Germany, 2006]

Table 6.25: Basic assumptions from the SCR plant in Germany

Comparison of costs for SNCR versus SCR					
Parameter	Unit	SNCR	SCR	SNCR	SCR
NO <sub>x</sub> target value	mg/Nm <sup>3</sup>	500	500	200	200
NH <sub>3</sub> equivalent	kg/t	0.44	0.44	0.71	0.71
Stoichiometric factor		1.7	0.8	2.5	1.0
NH <sub>3</sub> (25 %) consumption	kg/t	3.02	1.42	7.11	2.84
NH <sub>3</sub> (25 %) consumption	kg/d	4.550	2.150	10.650	4.250
Number of catalytic layers			3		4
<b>Operating costs</b>					
NH <sub>3</sub> consumption	EUR/t	0.27	0.13	0.64	0.26
Electrical energy consumption	EUR/t	0.03	0.10	0.06	0.11
Catalyst replacement costs	EUR/t		0.10		0.13
TOTAL	EUR/t	0.30	0.33	0.70	0.50
<b>Investment costs</b>					
Ammonia system	EUR	600000	250000	1000000	350000
SCR reactor (except catalysts)	EUR		1950000		2350000
TOTAL	EUR	600000	2200000	1000000	2700000
Specific investment costs <sup>(1)</sup>	EUR/t	0.08	0.30	0.14	0.37
Total specific costs <sup>(2)</sup>	EUR/t	0.38	0.62	0.83	0.87
NO <sub>x</sub> abatement costs	EUR/t NO <sub>x</sub>	330.00	540.00	450.00	470.00
<sup>(1)</sup> Specific investments					
<sup>(2)</sup> Total operating costs and specific investment costs					

Source: [76, Germany, 2006]

Table 6.26: Comparison of costs for the NO<sub>x</sub> abatement techniques of SNCR versus SCR from German UBA for a German plant

A cost calculation of the German cement industry carried out by the Association of German Engineers (VDZ) comprises a detailed approach concerning the costs of the SCR technique. Besides the investment costs, this study also considers the entire operating costs including the costs for ammonia water, power consumption due to compressed air for the cleaning of the catalyst and the pressure drop due to the catalyst itself along with other typical economic assessment figures for a cement plant. Here it was shown that the costs for SNCR are always lower than those for SCR if European energy and NH<sub>3</sub> prices are used as a basis. Theoretically,

SCR could only become less costly than SNCR at very high reduction rates, if NH<sub>3</sub> prices would rise significantly and if energy prices would decrease. This situation, however, seems not be applicable for the EU region, since ammonia and energy costs are not opposing each other, as they tend to rise and fall concurrently. It could also be shown that efforts to reduce NO<sub>x</sub> by primary techniques (~800 mg/m<sup>3</sup> which was the average in Germany in 2007) brought about better economics for SNCR, as costs for these are largely influenced by the costs for ammonia.

The SCR results have shown cost levels in a range of EUR 1.25 to 2.00 per tonne, depending on plant size and NO<sub>x</sub> removal efficiency required. In contrast to SNCR, SCR is dominated by the investment costs, which are four to nine times higher than for an SNCR system. Furthermore, the energy consumption is essentially due to pressure drop and cleaning air for the catalyst. The latest specific figures for the SCR system reflect the development of the technique. As an earlier VDZ study stated, EUR 3 per tonne clinker was the specific cost for SCR, although this value figure has decreased to around EUR 1.75 per tonne in 2006 [76, Germany, 2006].

Costs calculated by VDZ for a full scale installation with a kiln capacity of 1500 t clinker/d, initial emissions of 1200 mg/Nm<sup>3</sup> and a final level of 200, 500 and 800 mg/Nm<sup>3</sup>, is shown in Table 6.27.

Technique	Kiln system Applicability	Reduction Efficiency	Reported costs	
			Investment costs (EUR million)	Operating costs (EUR)
SCR	Possibly all	85 – 95 %	3.2 – 4.2	0.54 – 0.94

*Source: [76, Germany, 2006]*

**Table 6.27:** Cost calculations for NO<sub>x</sub> abatement by using SCR for a German cement plant with a capacity of 1500 t/d

## 6.2.6 Cement manufacturing – guideline regarding the control of CO trips

In most cases in the dry process of cement manufacturing, the hot exhaust gas provides heat for the raw mill (compound operation). If the raw mill is not running (direct operation), the gases are normally cooled down by water spraying in a conditioning tower before being treated in the dust collector, both to reduce gas volume and to improve precipitation characteristics, where the latter is especially important for electrostatic precipitators.

The kiln/raw mill exhaust gas as such is composed of different constituents, such as CO<sub>2</sub>, N<sub>2</sub>, water vapour and oxygen. To a much lesser extent, it contains NO and SO<sub>x</sub> as well as CO. CO can be found in flue-gas at concentrations of up to 0.1 % with additional CO originating from carbon in the raw materials.

The term 'CO trips' applies to ESPs and, to some extent, to hybrid filters, as they will have to be shut down during elevated CO levels in the flue-gases for safety reasons. Such a shutdown will, in turn, inflict an increase in dust emissions, which will be in the order of a few seconds to some minutes. An automatic CO monitoring device needs to monitor the flue-gas continuously. When this device is optimised for reaction time as well as shutdown procedure, and is properly maintained, the ESP will perform in accordance with its specifications. Applied on kilns with secondary firing, further operational reliability of the filters can be secured through sequential shutdown of the firing system during a CO trip.

### 6.2.6.1 Objectives for reducing operational interruptions – CO trips

The carbon monoxide originating from any organic content in the raw materials will be emitted with the kiln gases. However, in addition to the CO background level, additional CO trips arise when fuel feed and/or combustion air ratio control is inadequate. CO trips can occur within a couple of minutes, or even seconds, rapidly reaching an operational interruption limit (see Section 1.3.4.1.1).

The main objective is, therefore, to proactively minimise operation disruptions – ultimately rule out ESP explosions – by managerial methods. Consequently, control of the CO level in a cement kiln is important, particularly where ESPs are used for particulate abatement. If the CO trip cannot be suppressed, any ignition sources, particularly the high tension equipment of the ESPs, require special attention. A trip of the high tension equipment as such is the last resort and is undesirable. Other potential ignition sources can be static loads caused by solid/solid frictions or also fans, possible for any dust collection system.

In general, the critical limit is >8 % CO or - CH<sub>4</sub> - in the presence of >6 % O<sub>2</sub>. In reality, the CO trip travels through the gas train swiftly and will reach the critical area for an ignition source before the analysing system is able to indicate an alarm. Therefore, the action level has to be significantly lower than the theoretical level, and is further dependent on the CH<sub>4</sub> and H<sub>2</sub> concentrations, especially when natural gas is used as fuel. In certain cases, the ESP is tripped well below the critical limit whilst in others, the ESP systems can be improperly protected.

The high tension equipment trip level depends on the dead time. This is, in turn, dependent on the location, type and arrangement of the analysis equipment. The slower the response time of the analysing equipment and the shorter the hold up time from the analysing point to the ignition source is, the lower the action level has to be.

Surveys show that disruptions predominantly happen during the start-up operation phase. Therefore, for safe operation, it is crucial that the gas analysers for ESP protection are on-line during all operational phases, not only during normal operation. In order to reduce plant downtime, it may also be useful to have a backup system in operation.

### 6.2.6.2 Strategy of CO minimisation development

In order to reduce ESP downtime, a systematic stepwise approach is needed as described below:

- set objectives and assess the situation in respect of main factors influencing CO trips, such as causes of CO trips due to fuel feed or poor combustion
- compare and evaluate current and optimum situations, identification of optimisation potential and setting priorities – gap analysis
- optimisation of the process, the analysis system, ensuring availability, reliability and speed, optimisation of reaction techniques.

In the assessment phase location, reliability, availability and dynamic behaviour of analysing equipment besides CO development statistics are all needed along with fuel and process information. These can be correlated to identify any cause and address counter techniques.

CO trips can be caused by unstable operation of the combustion system. This can occur with any fuel, but especially with solid fuel. Therefore the fuel feeding systems must be designed to prevent surges of fuel into the kiln system at any time. The conveying properties of solid fuels are particularly critical factors in this respect and must be carefully controlled to prevent hold ups or blockages in the fuel preparation and feeding systems. However, equally important is the need to keep the normal CO emissions as low as possible, thereby increasing the distance to the action level providing more reaction time. This is done by means of improvement in combustion such as optimisation and quality of the fuel feed, burner properties and configuration, kiln draft, combustion temperature and residence time.

### 6.2.6.3 CO monitoring system

The ideal CO monitoring system has a short response time and should be situated close to the source of the CO, such as at a preheater tower outlet, or at a kiln inlet in the case of a wet kiln application. Still, a dead time analysis of the entire system – including hold up time due to duct volume – needs to be carried out. Ideally the dead time for the CO gas sample to travel from the suction point to the analyser will be in the region of 20 – 30 seconds (analysing lag time). Adding an additional 10 – 30 seconds lag time, as the analysing reaction time, should give the total maximum dead time before approximately 85 % of the maximum value has been reached. The total dead time determines when action has to be taken – not too early and not too late. If a more detailed analysis of the slope of the CO signal is carried out, a more precise prediction can be made when the ESP high tension system has to be shutdown and when it can be put back into full operation again – hence accounting for when the CO trip has left the critical area.

The CO monitoring lag time can be reduced by an increased sample flow, shortening the distance from the sampling point to the analyser, reduced volume in the analysing system and a quick electronic reporting signal. Rapid in situ systems with response times of <3 seconds are available on the market, but these have limitations in high dust-laden gases. In general, a strict maintenance and calibration regime is essential. However, analyser ranges and components have to appropriately address critical limits of up to 5 % for CO and 3 % for CH<sub>4</sub> respectively.

#### 6.2.6.4 Actions to be taken in the event of a CO trip

An example of primary techniques which can be used to prevent CO trips in ESPs is described in Table 6.28. Standard staged actions may firstly include reducing fuel feed and the high tension level. Thereafter, cutting the fuel feed entirely and tripping the high tension transformers automatically. The system then needs to be purged by keeping the fans in operation. The necessary purge time can be determined in the same way as the lag time.

Primary techniques to prevent CO trips		
Measuring point	CO level (%)	Measure
In the preheater tower	0.5	Alarm, shutdown of precalciner/kiln inlet firing system
	1.2	Shutdown of main firing system
	2.5	Shutdown of high tension electrostatic precipitator
After the preheater tower	0.5	Alarm, shutdown of precalciner/kiln inlet firing system
	0.8	Shutdown of main firing system
	1.5	Shutdown of high tension electrostatic precipitator
	0.5	Restart of ESP high tension equipment
<i>Source:</i> [60, VDI 2094 Germany, 2003], [83, CEMBUREAU, 2006]		

**Table 6.28:** Example of primary techniques to prevent CO trips from ESPs

#### 6.2.6.5 CO and CH<sub>4</sub> in fabric filters

Fabric filters operated in overcritical atmospheres may also experience problems. Therefore, the operational CO level should also be kept as low as possible. As with ESPs, additional combustible gas components such as CH<sub>4</sub> and H<sub>2</sub> will lower the critical level, i.e. if hydrogen of approximately 2 % is present, the critical level is reduced to ~5 %.

Specific potential ignition sources for fabric filters can be static loads caused by the friction of man-made fibres or – in the event of hybrid filters (combination of an ESP with a fabric filter) – the accumulated static load on the bags. To prevent interruptions, especially for coal mills, bags are fitted with a stainless steel fibre mesh or a conducting surface and are grounded to the baghouse cell plate. Similarly for hybrid dust collectors, the grounding of the bag support cage with the cell plate is recommended.

As with the ESP system, the CO has to be purged out. Purging of coal mills is preferably done by means of inert gas, such as kiln gas, CO<sub>2</sub> or N<sub>2</sub> [83, CEMBUREAU, 2006].

## 6.3 Annex lime manufacturing

### 6.3.1 Lime manufacturing – distribution of metal concentrations in the flue-gas of lime kilns in the EU-27

The following figures (Figure 6.10 to Figure 6.25) show the corresponding distributions of different metal concentrations in the flue-gas of lime kilns in the EU-27 (see also Section 2.3.3.9) [56, EuLA, 2006].

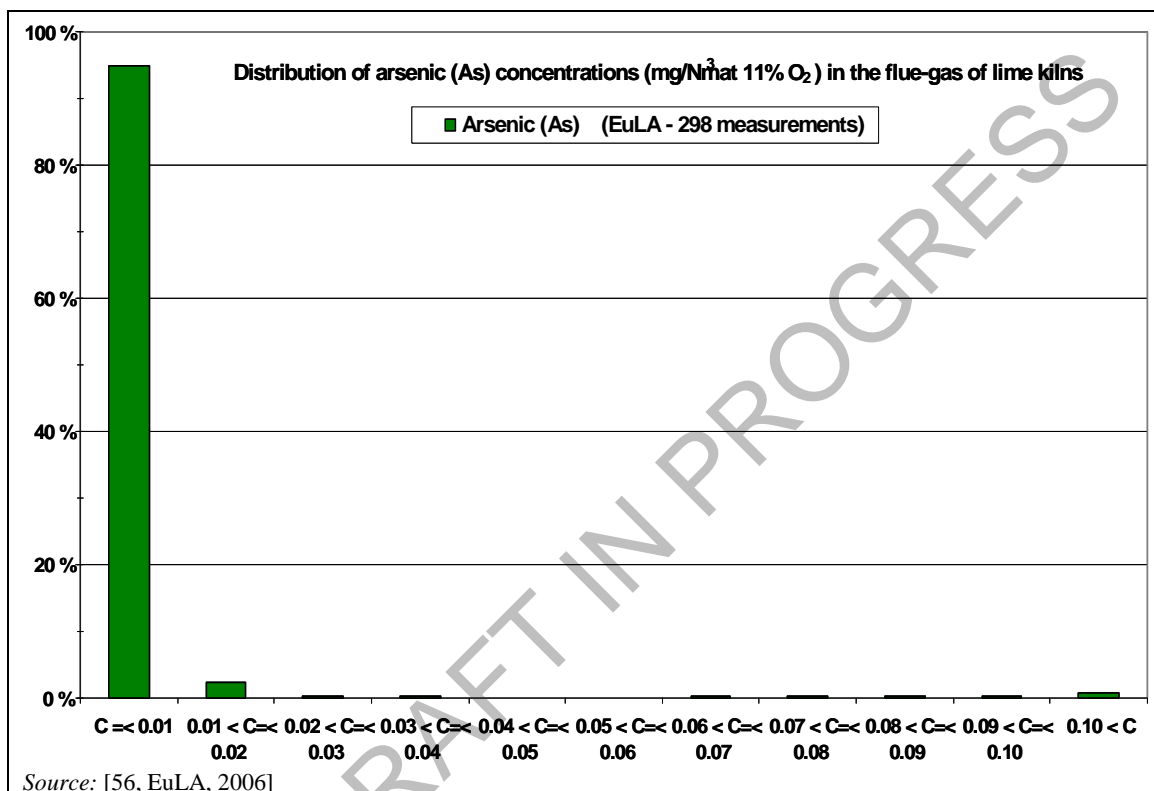


Figure 6.10: Distribution of arsenic concentrations in the flue-gas of lime kilns in the EU-27

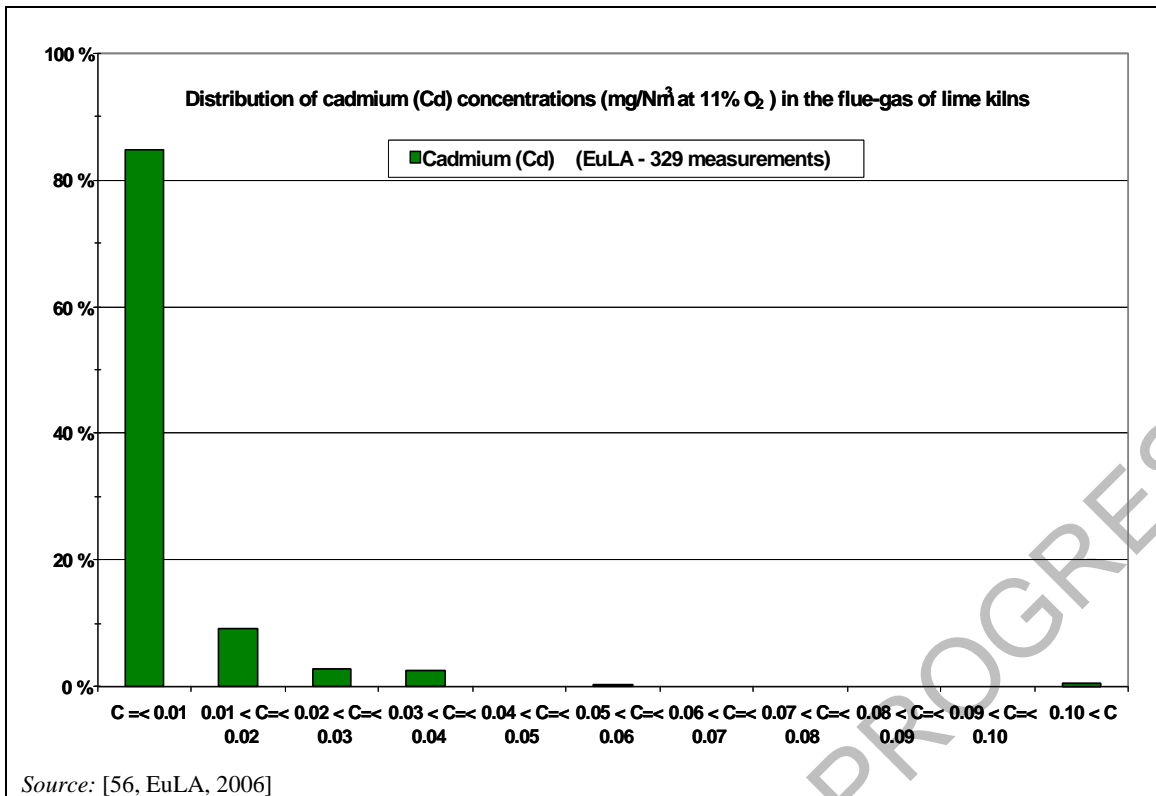


Figure 6.11: Distribution of cadmium concentrations in the flue-gas of lime kilns in the EU-27

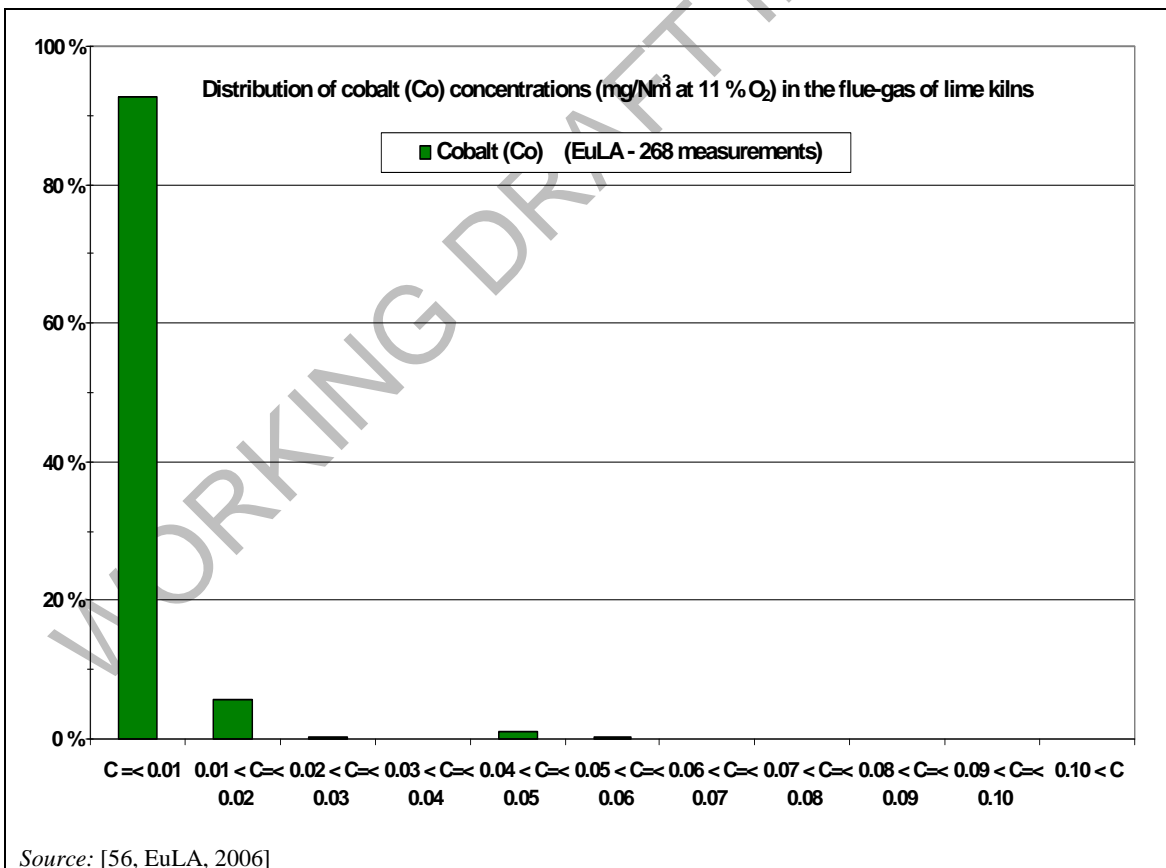


Figure 6.12: Distribution of cobalt concentrations in the flue-gas of lime kilns in the EU-27



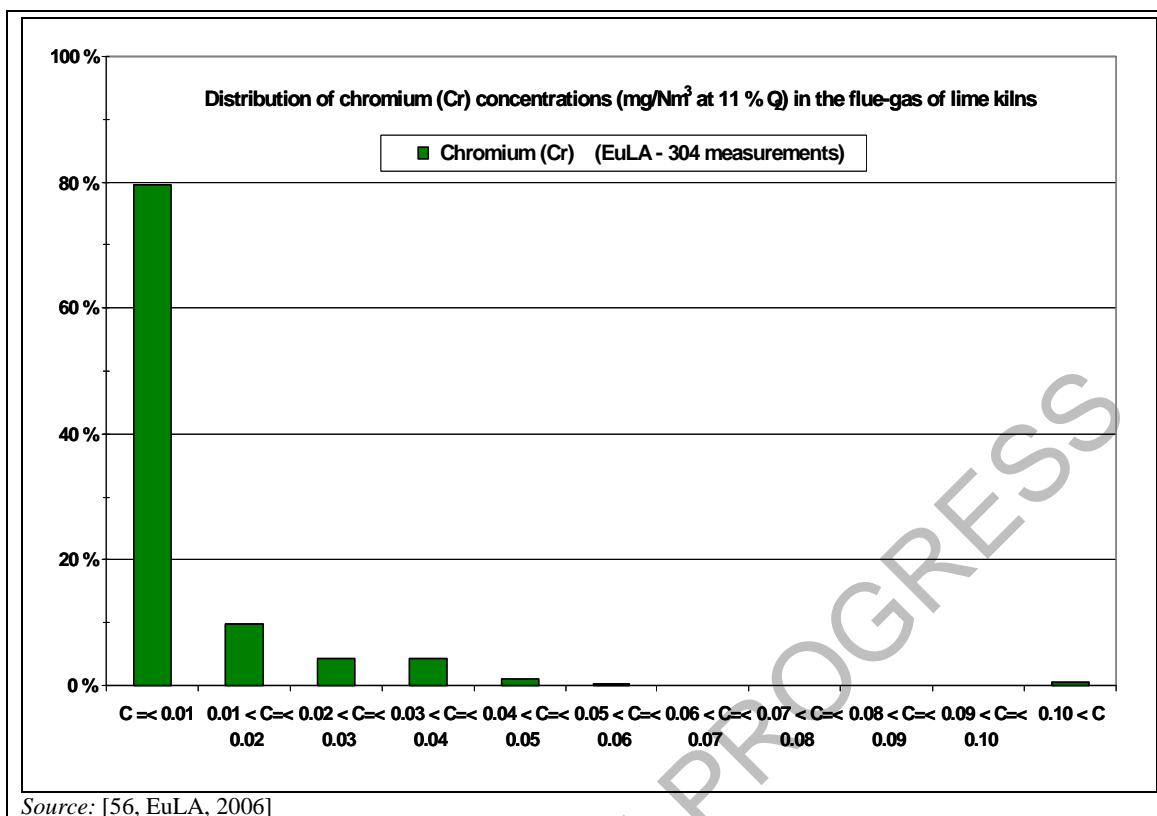


Figure 6.13: Distribution of chromium concentrations in the flue-gas of lime kilns in the EU-27

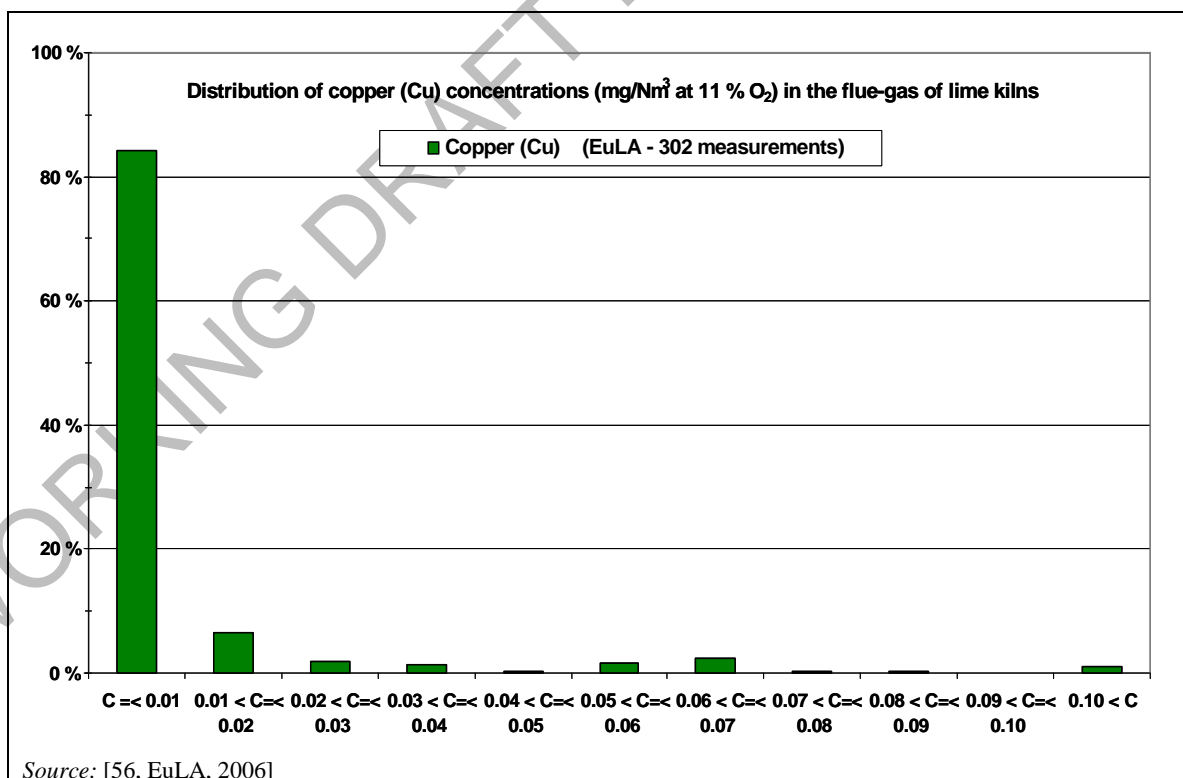


Figure 6.14: Distribution of copper concentrations in the flue-gas of lime kilns in the EU-27

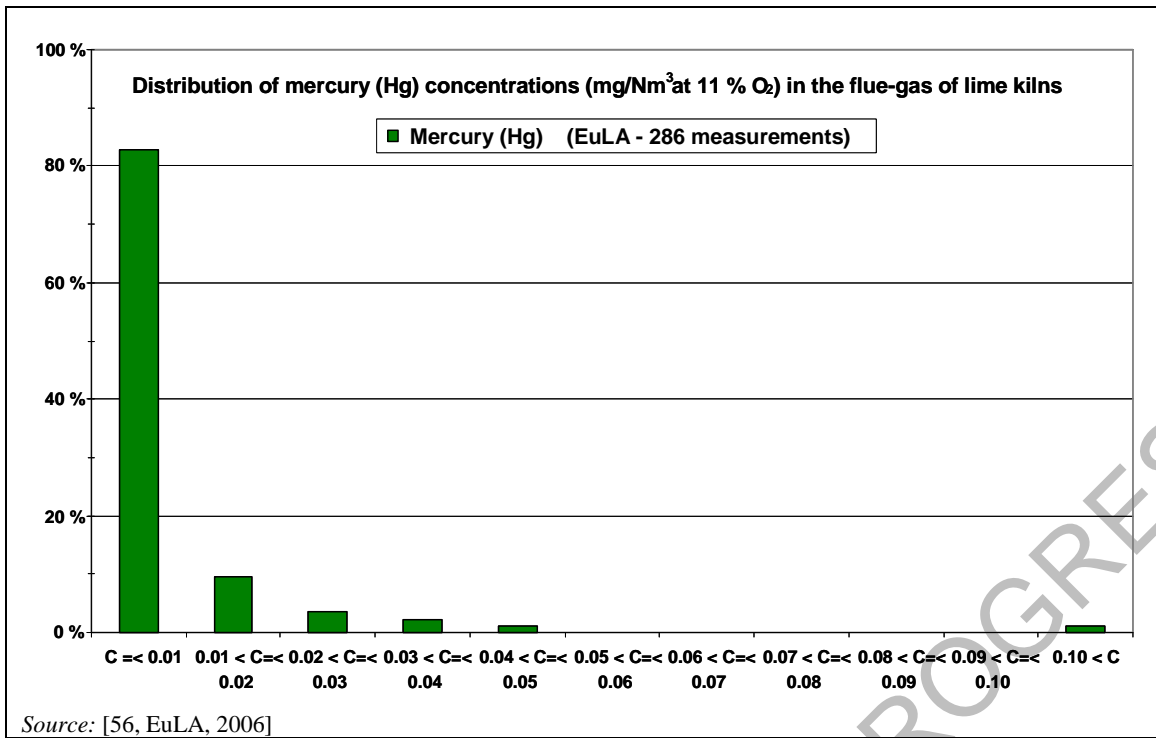


Figure 6.15: Distribution of mercury concentrations in the flue-gas of lime kilns in the EU-27

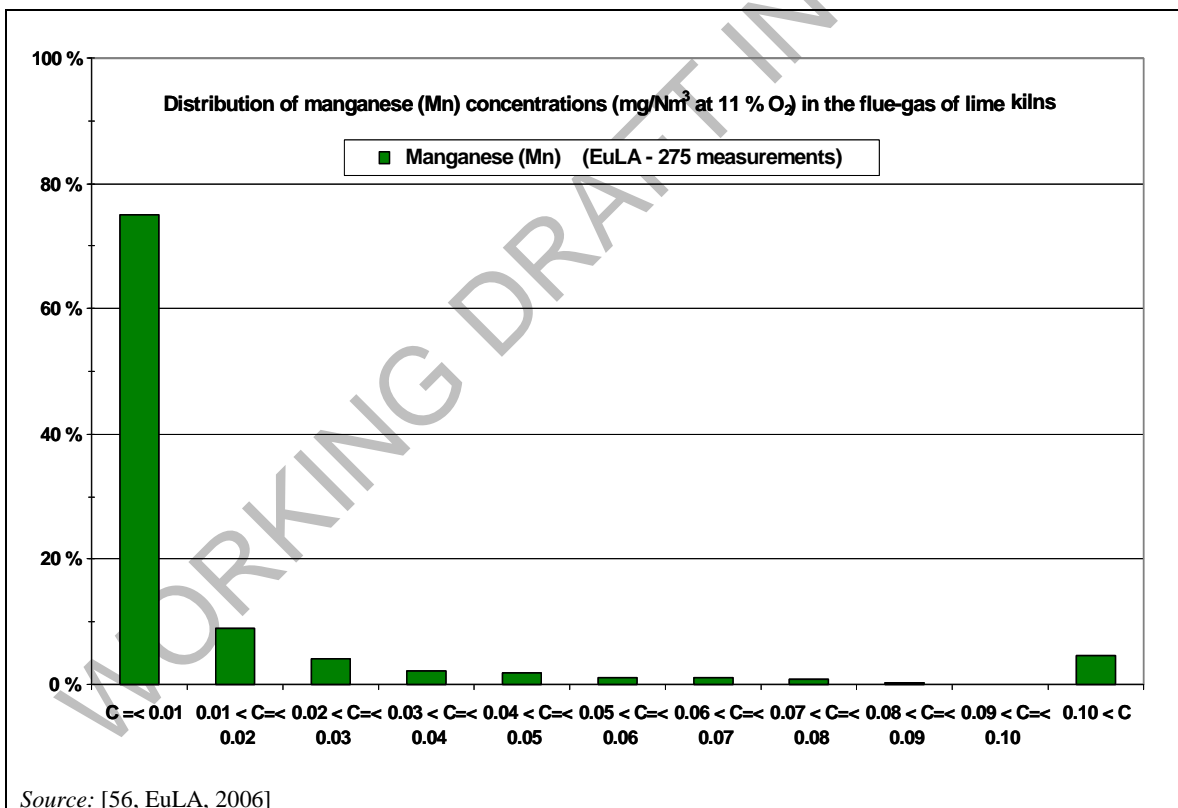
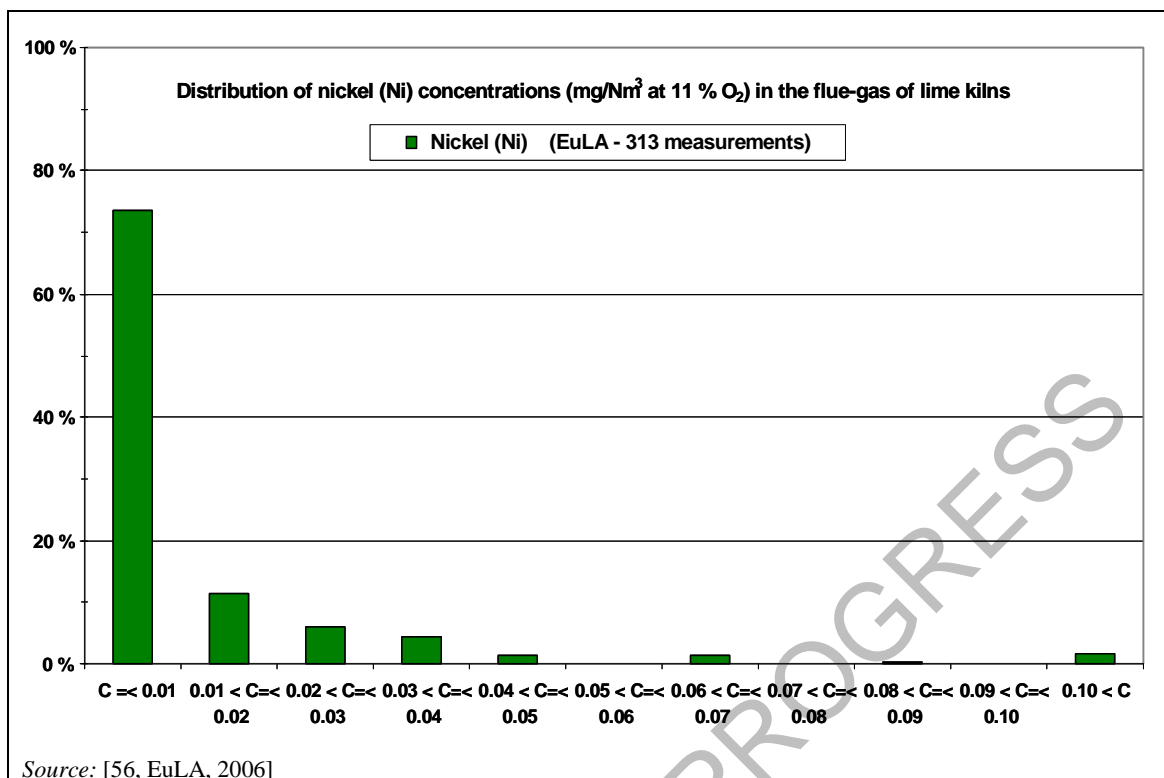
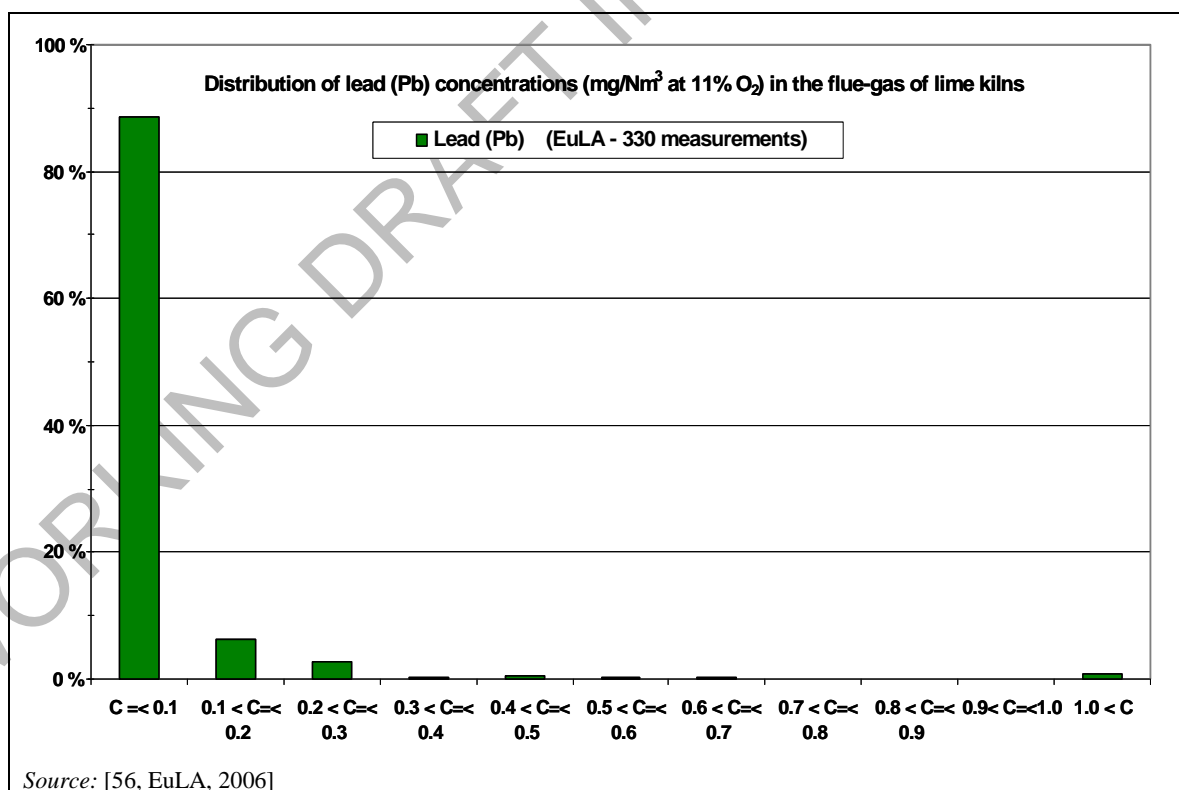


Figure 6.16: Distribution of manganese concentrations in the flue-gas of lime kilns in the EU-27



**Figure 6.17:** Distribution of nickel concentrations in the flue-gas of lime kilns in the EU-27



**Figure 6.18:** Distribution of lead concentrations in the flue-gas of lime kilns in the EU-27

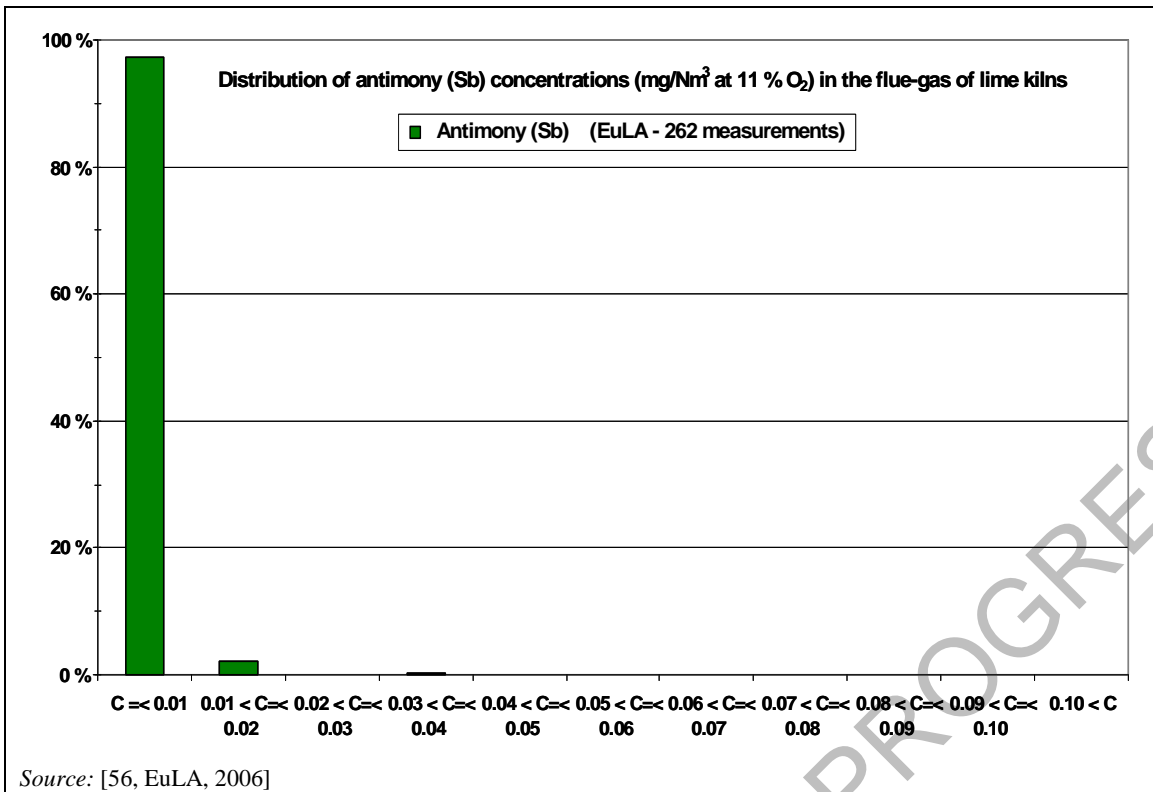


Figure 6.19: Distribution of antimony concentrations in the flue-gas of lime kilns in the EU-27

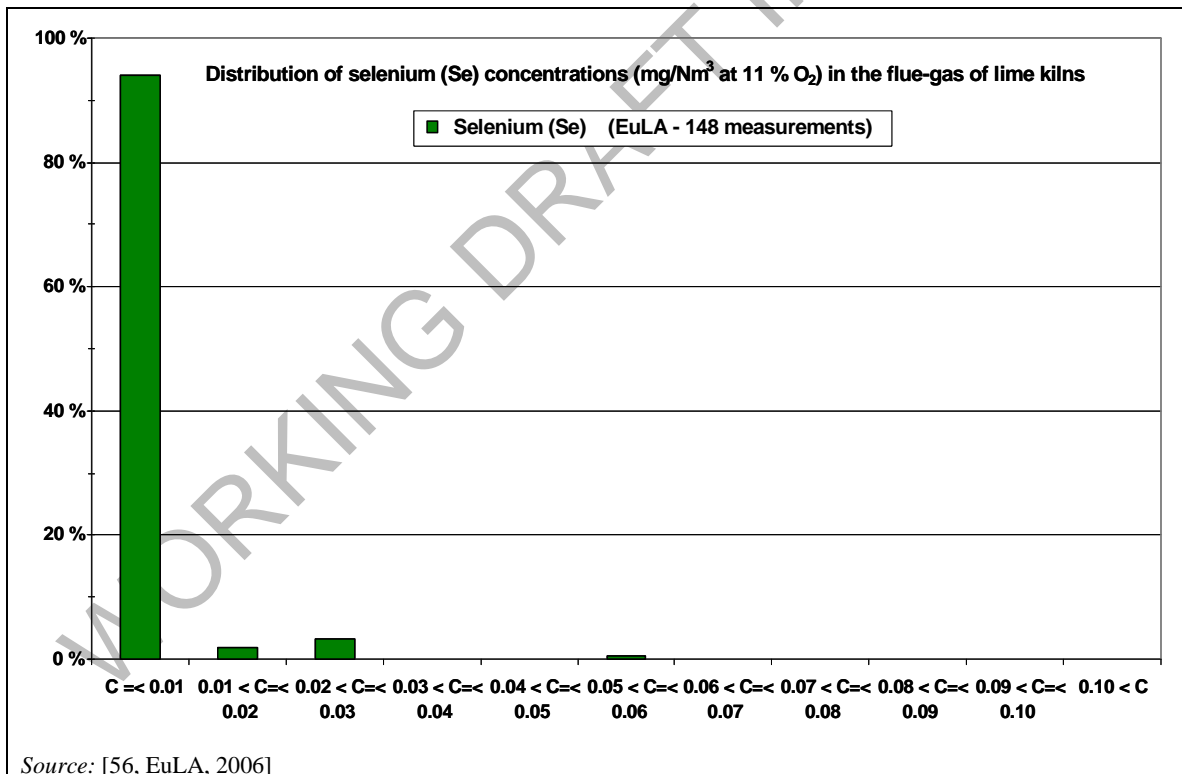


Figure 6.20: Distribution of selenium concentrations in the flue-gas of lime kilns in the EU-27

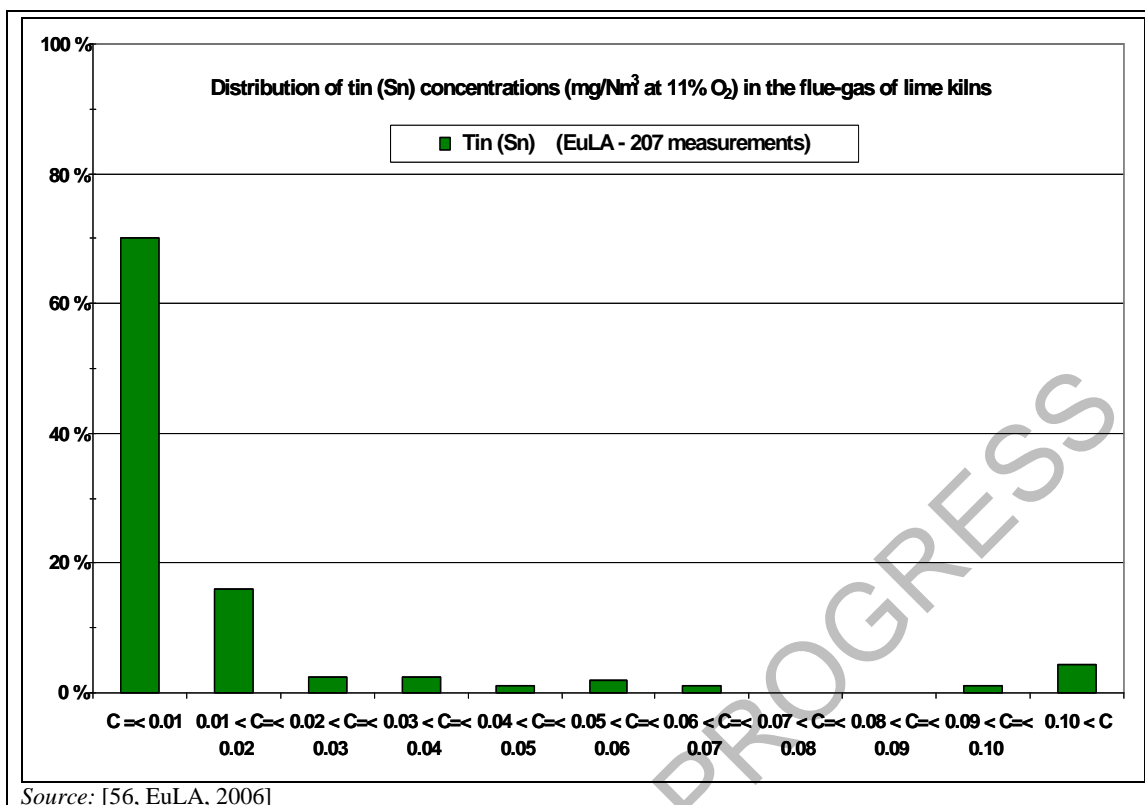


Figure 6.21: Distribution of tin concentrations in the flue-gas of lime kilns in the EU-27

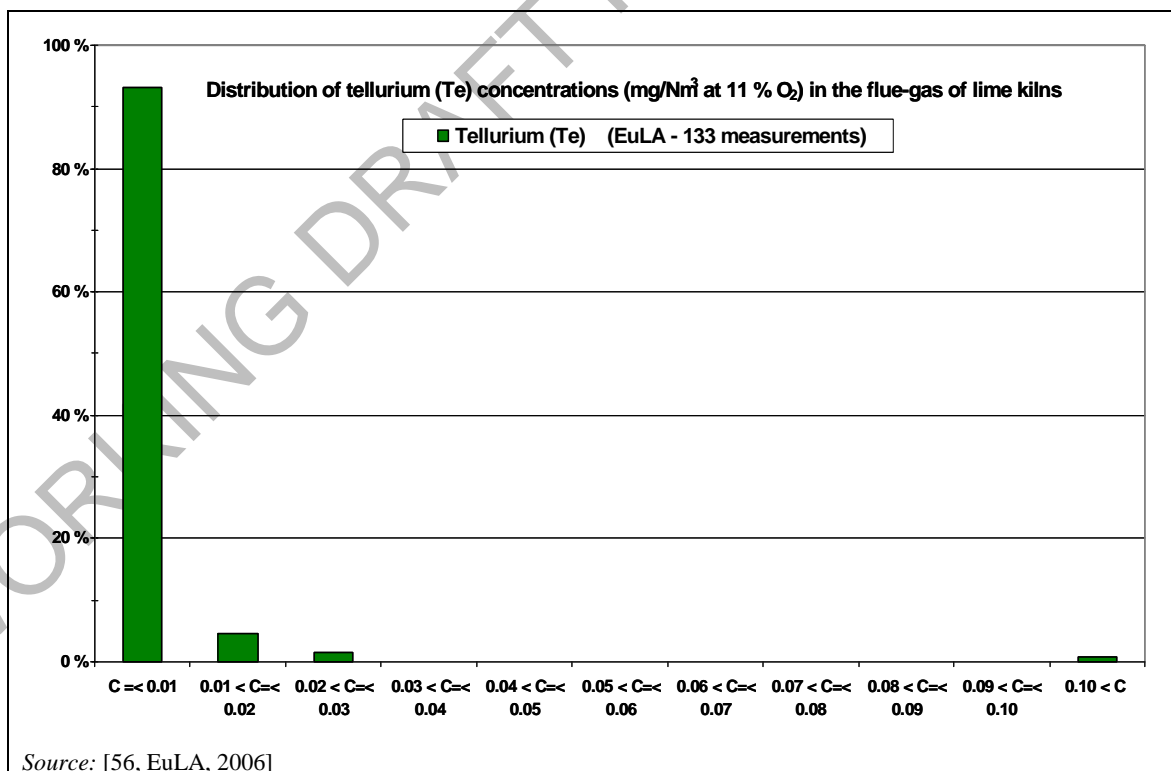


Figure 6.22: Distribution of tellurium concentrations in the flue-gas of lime kilns in the EU-27

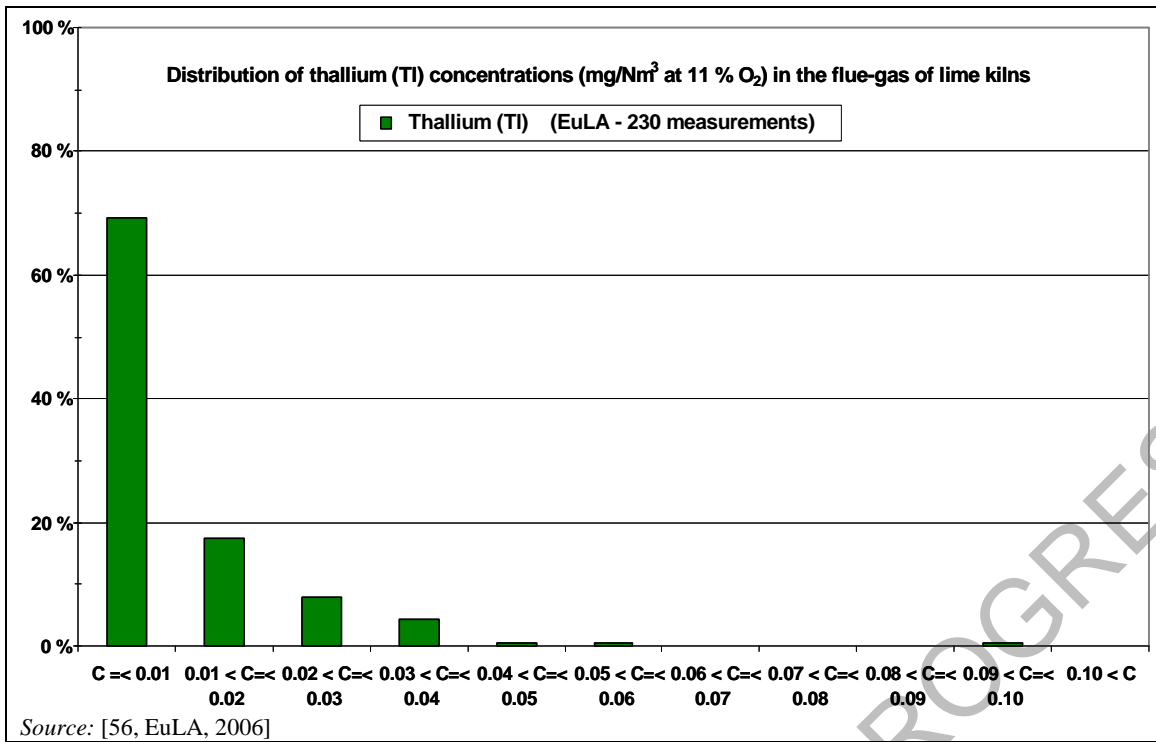


Figure 6.23: Distribution of thallium concentrations in the flue-gas of lime kilns in the EU-27

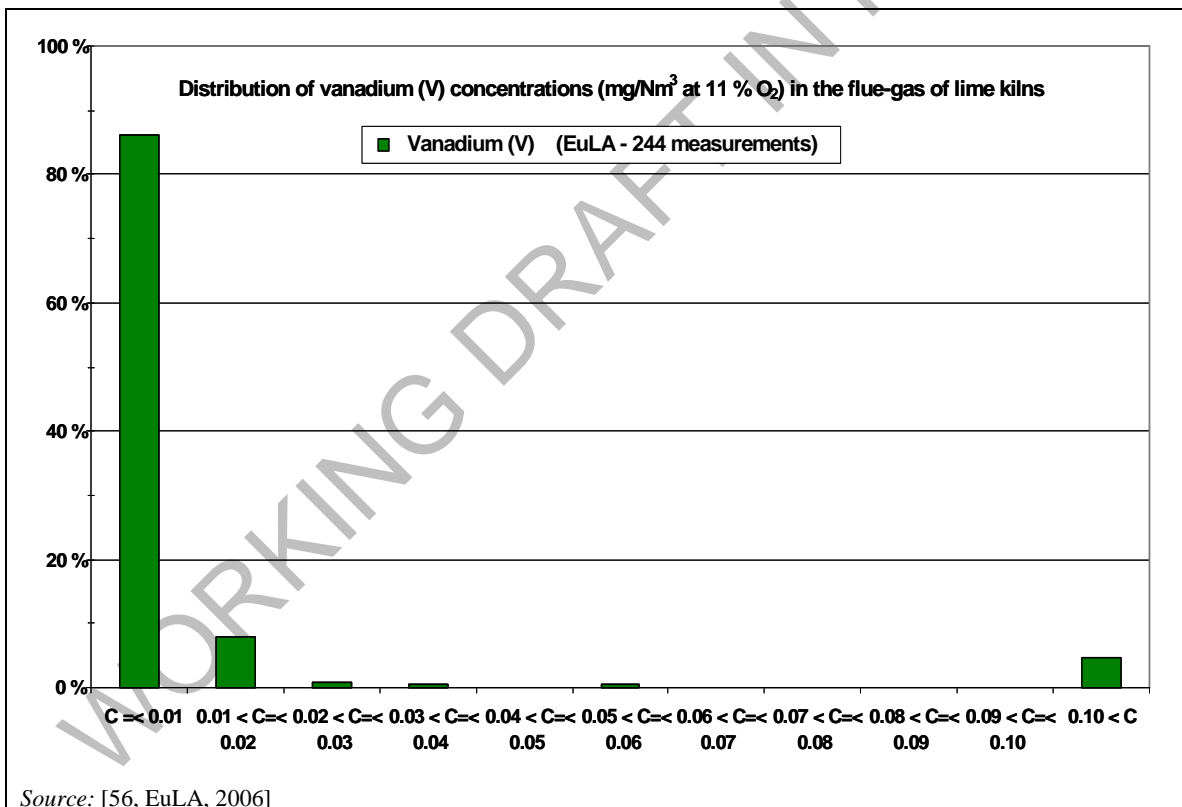


Figure 6.24: Distribution of vanadium concentrations in the flue-gas of lime kilns in the EU-27

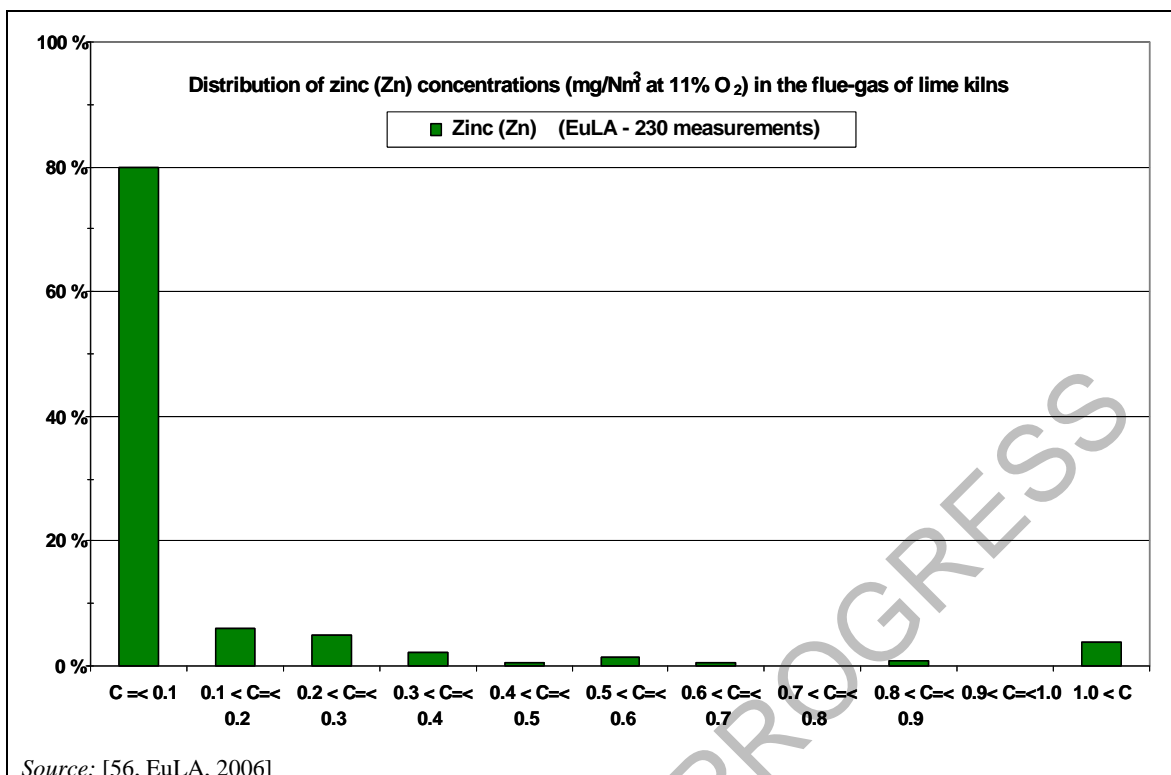


Figure 6.25: Distribution of zinc concentrations in the flue-gas of lime kilns in the EU-27

### 6.3.2 Lime manufacturing – plant specific data

#### 6.3.2.1 Examples of raw material characteristics

An example of raw material composition from used limestone in a Hungarian lime plant is shown in Table 6.29.

Parameter	Unit	Amount
SiO <sub>2</sub>	%	0.30
Fe <sub>2</sub> O <sub>3</sub>	%	0.09
Al <sub>2</sub> O <sub>3</sub>	%	0.27
TiO <sub>2</sub>	%	0.01
CaO	%	54.94
MgO	%	0.91
K <sub>2</sub> O	%	0.01
Na <sub>2</sub> O	%	0.01
SO <sub>3</sub>	%	0.10
CO <sub>2</sub>	%	43.05
Cl	%	<0.01
Loss on ignition	%	43.11

Source: [70, Hungary, 2006]

Table 6.29: Example of raw material composition used in a Hungarian lime plant

#### 6.3.2.2 Use of waste as fuels – examples of acceptable pollutant contents in wastes

Examples from Germany listing parameters and pollutant contents which are accepted for different types of waste, i.e. waste oil and solvents, animal fat and animal meal (carcase meal) are shown in Table 6.30. Furthermore, examples of permit criteria for substances along with calorific values for different waste fuels used in German lime plants are shown in Table 6.31.

Parameter	Unit	Waste oil and solvents		Animal fat	Animal meal (carcase meal) <sup>(2)</sup>
		Pollutant content		Pollutant content	Pollutant content
		Average	Minimum - maximum	Minimum - maximum	Minimum - maximum
Water content	mass %	5	3 – 9		3.0 – 5.7
Coke residue	mass %	1	0.6 – 1.4		
Carbon	mass %				1.0 – 59.0
Ash content	mass %	0.8	0.4 – 1.2		3.2 – 38.5
Sulphur	mass %	0.8	0.5 – 1.2	<0.01 – 0.03	
Chlorine	mass %	0.2	0.05 – 0.4	25 – 32	0.18 – 0.37
Fluorine	mass %				0.02 – 0.10
Nitrogen	mass %			460 – 590	
<b>Metals</b>					
Cadmium	mg/kg	0.1	<1	<0.001 – 0.05	
Thallium	mg/kg	<0.5	<1	<0.001 – 0.1	0.1 – 10.0
Mercury	mg/kg	<0.1	<0.5	<0.01 – 0.8	0.05 – 1.0
Antimony	mg/kg	<1	<5		0.4 – 10.0
Arsenic	mg/kg	<0.1	<1		
Lead	mg/kg	51	<100		0.7 – 10.0
Chromium	mg/kg	3	<10		3.0 – 63.0
Cobalt	mg/kg	1	<5		0.1 – 9.0
Copper	mg/kg	120	<250		5.2 – 50.0
Manganese	mg/kg	5	<10		5.6 – 45.0
Nickel	mg/kg	2	<10		1.0 – 39.0
Vanadium	mg/kg	<1	<1		1.1 – 20.0
Tin	mg/kg	<4	<4		0.3 – 7.2
Arsenic	mg/kg				0.6 – 11.0
Cadmium	mg/kg				0.1 – 1.0
∑ Sb, As, Pb, Cr, Co, Cu, Mn, Ni, V, Sn	mg/kg	<188	<400	<0.1 – 0.9	
∑ Ni, V	mg/kg			<0.2	
Total PCB <sup>(1)</sup>	mg/kg	10	25		
<sup>(1)</sup> According with DIN EN 12 766, part 2, process B <sup>(2)</sup> Waste fuel: SRM-meal (carcase meal), calorific value: <ul style="list-style-type: none"> <li>• min=14 MJ/kg</li> <li>• max=21.5 MJ/kg</li> </ul> Source: [155, Germany, 2007]					

**Table 6.30:** Typical pollutant contents accepted for waste oil solvents, animal fat and animal meal (carcase meal) used in German lime plants



Parameter	Waste fuel 1		Waste fuel 2		Waste fuel 3		Waste fuel 4	
	Median value	Maximum value	Median value	Maximum value	Median value	Maximum value	Median value	Maximum value
	(mg/kg)							
Hg	0.4	1.0	0.4	1.0	0.4	1.0	0.6	1.2
Cd	4.0	15.0	4.0	15.0	4.0	10.0	4.0	9.0
Tl	1.0	5.0	1.0	5.0	1.0	5.0	1.0	2.0
As	5.9	10.0	5.0	10.0	5.0	15.0	5.0	13.0
Co	5.0	10.0	5.0	10.0	5.0	10.0	6.0	12.0
Ni	20.0	100.0	20.0	100.0	20.0	100.0	25.0	50.0
Sb	40.0	100.0	40.0	100.0	25.0	60.0	25.0	60.0
Pb	40.0	100.0	40.0	100.0	40.0	100.0	70.0	200.0
Cr	40.0	100.0	40.0	100.0	40.0	100.0	40.0	120.0
Cu	100.0	250.0	90.0	250.0	90.0	500.0	120.0	300.0
Mn	50.0	100.0	50.0	100.0	50.0	100.0	50.0	100.0
V	10.0	20.0	10.0	20.0	10.0	20.0	10.0	25.0
Sn	15.0	50.0	15.0	50.0	15.0	75.0	30.0	70.0
Total Cl	7000.0	10000.0	7000.0	10000.0	7000.0	10000.0	7000.0	10000.0
Total F	250.0	500.0	250.0	500.0	250.0	1000.0	250.0	1000.0
Be	0.5	5.0	0.5	5.0	0.5	5.0	0.5	2.0
Zn	400.0	500.0	400.0	500.0	400.0	1000.0	400.0	1000.0
PCB		<3		<1		<1		<1
	(% w/w)							
Moisture	8.0	<10.0	11.0	<12.5	18.0	<20.0	18.0	<20.0
Ash content	6.0	<7.0	8.0	<9.0	11.0	<15.0	11.0	<15.0
Total S	0.3	<0.5	0.3	<0.5	0.2	<0.3	0.2	<0.3
	(MJ/kg)							
Calorific value <sup>(1)</sup>	25 – 31		23 – 29		20 – 24		18 – 22	
Median value: 50 percentile value, based on practical experience taking into consideration the possible variation of the waste fuel composition								
Maximum value: 100 percentile value								
<sup>(1)</sup> Min – max								
Source: [50, Germany, 2006]								

**Table 6.31: Examples of permit criteria (median and maximum values) for substances for different waste fuels used in German lime plants**

### 6.3.2.3 Examples of consumptions and emissions data

#### Energy consumption

Table 6.32 shows operating data and specific energy demands for Austrian lime kilns in 2004. These different types of lime kilns use natural gas, heavy fuel oil and/or coke as fuel.

Parameter		Unit	Parallel flow regenerative kilns	Annular shaft kilns	Other shaft kilns
Capacity of single kilns		t/day	150 – 390	140 – 220	100 – 200
Specific energy demand		MJ/t <sub>lime</sub>	3500 – 3800	4200 – 4700	3800 – 5100
Used fuels			Natural gas, heavy fuel oil	Natural gas, heavy fuel oil	Natural gas, coke
Annual amount of used fuels (all kilns)	Natural gas	million Nm <sup>3</sup>	46	12	13
	Heavy fuel oil	t	4000	4500	-
	Coke	t	-	-	1000
Source: [66, Austria, 2006]					

**Table 6.32: Operating data and specific energy demand of Austrian lime kilns in 2004**

On average the energy demand of burning lime in Austria is about 3760 MJ/t lime. The correlation between the size of the kiln and the energy demand is not as significant as when producing cement, because radiation losses are lower. One factor influencing the energy demand is the residual content of CO<sub>2</sub> in the products; it depends on the reactivity of the lime product. The energy demand is higher for hard burned lime than for soft burned lime. The energy demand also depends on the residual CO<sub>2</sub>. The lower energy demand of the parallel flow regenerative kiln, and partly of other kilns, depends on the high residual content of CO<sub>2</sub> (>5 %) in the products. For producing lime with a low residual CO<sub>2</sub> content, the energy demand increases [66, Austria, 2006], [168, TWG CLM, 2007].

The examples of energy consumption in the manufacture of lime in Spain shown in Table 6.33 are average values. The weighted average value calculated for the Spanish lime kilns is 3.984 GJ/tonne lime. A value of 3.681 GJ/tonne lime is expected for the period 2008 – 2012 [55, Spain, 2006].

Kiln type	Number	Percentage (%)	Updated energy consumption GJ/tonne lime		
			Minimum	Average	Maximum
Long rotary kilns (LRK)	4	7		6.6 <sup>(1)</sup>	
Rotary kilns with preheater (PRK)	1	2	5.4	-	-
Parallel flow regenerative kilns (PFRK)	35	61	3.534	3.752	3.889
Annular shaft kilns (ASK)	2	4	3.958	4.156	4.355
Mixed feed shaft kilns (MFSK)	-	-	-	-	-
Other kilns (OK) <sup>(2)</sup>	15	26	4.085	4.150	4.268

<sup>(1)</sup> companies from outside Spain. An energy consumption value of approximately 6.6 GJ/tonne lime is considered  
<sup>(2)</sup> other shaft kilns  
Source: [55, Spain, 2006]

**Table 6.33: Energy consumption by various types of lime kilns in Spain**

Compilation of emissions observed from individual EU Member States

Examples of typical examples of emissions from various types of lime kilns in Germany are shown in Table 6.34.

Kiln type	Emissions concentration <sup>(3)</sup>				
	NO <sub>x</sub> (mg/Nm <sup>3</sup> ) <sup>(1)</sup>	CO (mg/Nm <sup>3</sup> )	PCDD/F (ng I- TEQ/Nm <sup>3</sup> )	HCl <sup>(5)</sup> (mg/Nm <sup>3</sup> )	HF (mg/Nm <sup>3</sup> )
<b>Quicklime (soft to hard burned)</b>					
Long rotary kilns (LRK)	≤500	<1000	<0.1	<50	<1
Rotary kilns with preheater (PRK) <sup>(2)</sup>	≤1500	<1000	<0.1	<20	<1
Parallel flow regenerative kilns (PFRK)	<100 – <400	<1000	0.001 – <0.1	<10	<1
Annular shaft kilns (ASK)	<100 – <500	1000 – <3000	0.003 – <0.1	<40	<2
Mixed feed shaft kilns (MFSK)	<100 – <500	6000 – 42000	0.01 – <0.1 <sup>(4)</sup>	<20	<1
Other kilns (OK):					
• multi-chamber shaft kiln	<500	<2000	No data available	No data available	No data available
• double inclined shaft kiln	300 – <500	<2000	0.001 – <0.1	<10	<1
<b>Dolime (soft burned to sintered)</b>					
Long rotary kilns (LRK)	-	-	-	<150	<1
Rotary kilns with preheater (PRK)	-	-	-	<30	<1
Mixed feed shaft kilns (MFSK)	-	-	-	<20	<1
<b>Use of waste</b>				10 <sup>(6)</sup>	1 <sup>(6)</sup>
				60 <sup>(7)</sup>	4 <sup>(7)</sup>
<sup>(1)</sup> Nitrogen monoxide and nitrogen dioxide, to be indicated as nitrogen dioxide <sup>(2)</sup> Grate preheater rotary kiln <sup>(3)</sup> Emissions concentrations are measured as six hourly average values and related to 10 % O <sub>2</sub> to make values comparable <sup>(4)</sup> In one case, 0.26 ng I-TEQ/Nm <sup>3</sup> was measured at a mixed feed shaft kiln. This kiln was taken out of operation at the end of 2006 <sup>(5)</sup> Dependent upon the content of chlorine compounds in the limestone (50 – 100 ppm) <sup>(6)</sup> Daily average value <sup>(7)</sup> Half hourly average value Source: [46, Germany, 2006]					

**Table 6.34: Typical examples of emissions from lime kilns in Germany**

Examples of emissions were observed in lime plants in several EU Member States using different kilns and fuels as shown in Table 6.35.

EU member state	Dust emissions (mg/Nm <sup>3</sup> )	NO <sub>x</sub> emissions (mg/Nm <sup>3</sup> )	SO <sub>x</sub> emissions (mg/Nm <sup>3</sup> )	CO emissions (mg/Nm <sup>3</sup> )	TOC Emissions (mg/Nm <sup>3</sup> )	Kilns used	Fuels used
Germany	-	100 – 150 <sup>(1)</sup>	<100 <sup>(2)</sup>	-	-	Multi-chamber shaft kiln	-
	-	<500	-	-	-	RK	-
	-	-	-	-	<5 – >5 <sup>(7)</sup>	MFSK	-
	-	-	-	-	5 – <50 <sup>(8)</sup> <1 (benzene)	ASK	-
Special example from germany	-	-	-	-	995 14.6 <sup>(benzene)</sup>	ASK	-
Finland <sup>(6)</sup>	2 <sup>(3)</sup>	65	15	-	-	PFRK	Heavy fuel oil <sup>(4)</sup>
Hungary <sup>(6)</sup>	1.4	32.2	4.8	3.9	-	-	Natural gas
Czech republic <sup>(5)</sup>	-	400 t/yr	130 t/yr	-	-	-	-

(<sup>1</sup>) 10 % O<sub>2</sub>  
(<sup>2</sup>) If more than 60 % of the rated thermal capacity comes from waste (more than 40 % in the case of hazardous waste), 50 mg/Nm<sup>3</sup> is set as the daily average value, related to 10 % oxygen  
(<sup>3</sup>) Fabric filter  
(<sup>4</sup>) Low content of sulphur at 0.6 % and the raw material contains low sulphur as well  
(<sup>5</sup>) 2006  
(<sup>6</sup>) Spot measurements  
(<sup>7</sup>) Depends on the process conditions, MFSK not suitable for the use of wastes; for double inclined shaft kilns and multi-chamber shaft kilns no data are available  
(<sup>8</sup>) Kilns of this type that used waste like solvents or waste oil did not have higher emissions of TOC  
Source: [45, Schorcht, 2006] [46, Germany, 2006] [64, Czech Republic, 2006] [71, Hungary, 2006]

**Table 6.35: Examples of NO<sub>x</sub> emissions observed in EU Member States**

Emission values concerning different emissions from Austrian lime kilns are shown in Table 6.36. No techniques were being used in 2006 to reduce NO<sub>x</sub> emissions. Emissions of CO are reported from 0.007 to 0.22 g/Nm<sup>3</sup> related to a high residual CO<sub>2</sub> content and up to 5 g/Nm<sup>3</sup> related to a low residual CO<sub>2</sub> content. For annular shaft kilns, CO emissions range from 0.1 to 3 g/Nm<sup>3</sup>, and in other shaft kilns from 0.01 to 5 g/Nm<sup>3</sup>.

Parameter	Unit	Concentration <sup>(1)</sup> <sup>(2)</sup>		
		Parallel flow regenerative kilns <sup>(3)</sup>	Annular shaft kilns <sup>(3)</sup>	Other shaft kilns <sup>(3)</sup>
Flue-gas volume	Nm <sup>3</sup> /h	15 000 – 45 000	11 000 – 20 000	7 500 – 22 000
Oxygen content	vol-%	8 – 12	6 – 15	6 – 17.5
Dust	mg/Nm <sup>3</sup>	<20		
HCl	mg/Nm <sup>3</sup>	0.6 – 3.6		
HF	mg/Nm <sup>3</sup>	0.01 – 0.14		
NO <sub>x</sub> as NO <sub>2</sub>	mg/Nm <sup>3</sup>	<150	<250	<250
SO <sub>x</sub> as SO <sub>2</sub>	mg/Nm <sup>3</sup>	<100	<10	<20
CO	g/Nm <sup>3</sup>	0.007 – 0.22 (high residual CO <sub>2</sub> content) and up to 5 (low residual CO <sub>2</sub> )	0.1 – 3	0.01 – 5
Total C	mg/Nm <sup>3</sup>	<100	<10	<10
Σ (Cd, Tl) <sup>(4)</sup>	mg/Nm <sup>3</sup>	0.0001 – 0.002		
Hg	mg/Nm <sup>3</sup>	0.0001 – 0.003		
Σ (Sb, As, Pb, Cr, Co, Cu, Mn, Ni, Sn) <sup>(4)</sup>	mg/Nm <sup>3</sup>	0.0001 – 0.0052		
PCDD/F <sup>(4)</sup>	ng I-TEQ/Nm <sup>3</sup>	<0.05	<0.03	<0.03
Benzene	mg/Nm <sup>3</sup>	<0.04		
Benzo-a-pyrene <sup>(4)</sup>	mg/Nm <sup>3</sup>	<0.0003		

(<sup>1</sup>) Concentrations are single measures/techniques with measuring intervals of 30 minutes to one day  
(<sup>2</sup>) Refers to 10 % oxygen in the flue-gas  
(<sup>3</sup>) Fabric filters are used  
(<sup>4</sup>) The lower value gives the detection limit  
Source: [66, Austria, 2006]

**Table 6.36: Emissions from Austrian lime kilns**

Examples of emissions data achieved from several Finnish lime plants using different types of kilns are shown in Table 6.37. Emissions data in were collected from 1998 to 2006. Coal and coke, heavy or light fuel oil, coke gas or petcoke were used as fuels but no waste fuels were used. In 2005, dust emissions data of less than 5 mg/Nm<sup>3</sup> could be achieved by using an ESP in a rotary kiln and emissions ranges of between 1.7 and 2.2 mg/Nm<sup>3</sup> by using a fabric filter in an annular shaft kiln were achieved. Table 6.38 shows examples of metal emissions from a Finnish lime plant using regenerated fuel oil as fuel.

## Annexes

Emissions (mg/Nm <sup>3</sup> )	Plant Nr.	Kiln	Filter	Fuels	1998	O <sub>2</sub> <sup>(6)</sup> %	1999	O <sub>2</sub> <sup>(6)</sup> %	2000	O <sub>2</sub> <sup>(6)</sup> %	2001	O <sub>2</sub> <sup>(6)</sup> %	2002	O <sub>2</sub> <sup>(6)</sup> %	2003	O <sub>2</sub> <sup>(6)</sup> %	2004	O <sub>2</sub> <sup>(6)</sup> %	2005	O <sub>2</sub> <sup>(6)</sup> %	2006	O <sub>2</sub> <sup>(6)</sup> %	
Dust	Plant 1	LRK <sup>(1)</sup>	ESP <sup>(4)</sup>	Coal, coke 05	<10	6	32 – 18	7	<5 and 13	6.7	5	6.4	<5	6.1	<5	9.3	<5 <sup>(7)</sup>	12.5	<5	6			
		LRK <sup>(1)</sup>	ESP <sup>(4)</sup>	Coal, coke 05	156 – 113	10			192 and 9	10.7	14 <sup>(7)</sup>	11	<5 <sup>(7)</sup>	11	<5	10.9	34 – 41 <sup>(7)</sup>	11.6	<5 <sup>(7)</sup>	11			
	Plant 2	LRK <sup>(1)</sup>	ESP <sup>(4)</sup>	Coal							26 – 40	7			63 – 48	7.2 – 10					85 – 114	6.6	
	Plant 3	LRK <sup>(1)</sup>	ESP <sup>(4)</sup>	Coal					1 – 243 <sup>(8)</sup>	4.5								38 – 54	5.2				
		ASK <sup>(2)</sup>	Bag <sup>(5)</sup>	Heavy fuel oil, light fuel oil					12 <sup>(7)</sup>	11.9								0.7 – 1.1	4.3	2.2	1.7	5	
	Plant 4	LRK <sup>(1)</sup>	ESP <sup>(4)</sup>	Coal, coke 05			2468	6.5						130 – 149	7.2			255 – 335 <sup>(7)</sup>	12.6	154 – 229	8		
	Plant 5	PFRK <sup>(3)</sup>	Bag <sup>(5)</sup>	Coke gas	62									5				6	9.6				
Plant 6	PFRK <sup>(3)</sup>	Bag <sup>(5)</sup>	Regenerated fuel oil	38									5				79	9.6					
NO <sub>x</sub>	Plant 1	LRK <sup>(1)</sup>	ESP <sup>(4)</sup>	Coal, coke 05	868	6	620	7	771 ± 120, 910	6.7		6.4	898 ± 135	6.1	645 ± 100	9.3	685 ± 100 <sup>(7)</sup>	12.5	800 ± 160	6			
		LRK <sup>(1)</sup>	ESP <sup>(4)</sup>	Coal, coke 05	722	10	-	-	810	10.7	610 <sup>(7)</sup>	11	563 ± 110 <sup>(7)</sup>	11	730 ± 140	10.9	890 ± 110 <sup>(7)</sup>	11.6	970 ± 200 <sup>(7)</sup>	11			
	Plant 2	LRK <sup>(1)</sup>	ESP <sup>(4)</sup>	Coal							280	7			522 – 399	7.2 – 10					393 <sup>(9)</sup>	6.6	
	Plant 3	LRK <sup>(1)</sup>	ESP <sup>(4)</sup>	Coal					507	4.5								157 – 160	5.2				
		ASK <sup>(2)</sup>	Bag <sup>(5)</sup>	Heavy fuel oil, light fuel oil					167 – 101 <sup>(7)</sup>	11.9								243	4.3				
	Plant 4	LRK <sup>(1)</sup>	ESP <sup>(4)</sup>	Coal, coke 05			338 <sup>(10)</sup>	6.5						590 – 440	7.2			616 <sup>(7)</sup>	12.6	411 – 479 <sup>(11)</sup>	8		
	Plant 5	PFRK <sup>(3)</sup>	Bag <sup>(5)</sup>	Coke gas																			
Plant 6	PFRK <sup>(3)</sup>	Bag <sup>(5)</sup>	Regenerated fuel oil																	67 <sup>(9,10)</sup>			
SO <sub>2</sub>	Plant 1	LRK <sup>(1)</sup>	ESP <sup>(4)</sup>	Coal, coke 05	475	6	110	7	258 ± 40	6.7		6.4	173 ± 34	6.1	240 ± 35	9.3	950 ± 90 <sup>(7)</sup> , 214	12.5	241 ± 50	6			
		LRK <sup>(1)</sup>	ESP <sup>(4)</sup>	Coal, coke 05	390	10	-	-	350	10.7	330 <sup>(7)</sup>	11	210 ± 40 <sup>(7)</sup>	11	340 ± 50	10.9	410 ± 60 <sup>(7)</sup>	11.6	138 ± 28 <sup>(7)</sup>	11			
	Plant 2	LRK <sup>(1)</sup>	ESP <sup>(4)</sup>	Coal							<10	7			165 – 126	7.2 – 10					332 – 350	6.6	
	Plant 3	LRK <sup>(1)</sup>	ESP <sup>(4)</sup>	Coal						4.5									5.2				
ASK <sup>(2)</sup>		Bag <sup>(5)</sup>	Heavy fuel oil, light fuel oil						11.9								11	4.3					

	Plant 4	LRK <sup>(1)</sup>	ESP <sup>(4)</sup>	Coal, coke 05			143	6.5				66 – 142	7.2			851 <sup>(7)</sup>	12.6		8				
	Plant 5	PFRK <sup>(2)</sup>	Bag <sup>(5)</sup>	Coke gas																			
		PFRK <sup>(2)</sup>	Bag <sup>(5)</sup>	Coke gas																			
	Plant 6	PFRK <sup>(2)</sup>	Bag <sup>(5)</sup>	Regenerated fuel oil																15 <sup>(9)</sup>			
CO <sub>2</sub>	Plant 1	LRK <sup>(1)</sup>	ESP <sup>(4)</sup>	Coal, coke 05	476	6	430	7	467 ± 72, 453	6.7		6.4	432 ± 70	6.1	360 ± 55	9.3	260 ± 60 <sup>(7)</sup>	12.5	475 ± 70	6			
		LRK <sup>(1)</sup>	ESP <sup>(4)</sup>	Coal, coke 05	320	10	-	-	310	10.7	300 <sup>(7)</sup>	11	303 ± 16	11	340 ± 45	10.9	280 ± 60 <sup>(7)</sup>	11.6	285 ± 43 <sup>(7)</sup>	11			
	Plant 2	LRK <sup>(1)</sup>	ESP <sup>(4)</sup>	Coal								7			424 – 324	7.2 – 10				)	6.6		
	Plant 3	LRK <sup>(1)</sup>	ESP <sup>(4)</sup>	Coal					290	4.5												5.2	
		ASK <sup>(2)</sup>	Bag <sup>(5)</sup>	Heavy fuel oil, light fuel oil					292 <sup>(7)</sup>	11.9													4.3
	Plant 4	LRK <sup>(1)</sup>	ESP <sup>(4)</sup>	Coal, coke 05			490	6.5						7.2								8	
	Plant 5	PFRK <sup>(2)</sup>	Bag <sup>(5)</sup>	Coke gas																			
		PFRK <sup>(2)</sup>	Bag <sup>(5)</sup>	Coke gas																			
Plant 6	PFRK <sup>(2)</sup>	Bag <sup>(5)</sup>	Regenerated fuel oil																				
CO	Plant 1	LRK <sup>(1)</sup>	ESP <sup>(4)</sup>	Coal, coke 05	67	6	4	7	31	6.7		6.4	1	6.1	4	9.3	11 <sup>(7)</sup>	12.5		6			
		LRK <sup>(1)</sup>	ESP <sup>(4)</sup>	Coal, coke 05	68	10	-	-	65	10.7	42 <sup>(7)</sup>	11	80 <sup>(7)</sup>	11	160	10.9	80 ± 60 <sup>(7)</sup>	11.6	22 <sup>7</sup>	11			
	Plant 2	LRK <sup>(1)</sup>	ESP <sup>(4)</sup>	Coal								120	7		14	7.2 – 10					25.7 – 27	6.6	
	Plant 3	LRK <sup>(1)</sup>	ESP <sup>(4)</sup>	Coal						4.5													5.2
		ASK <sup>(2)</sup>	Bag <sup>(5)</sup>	Heavy fuel oil, light fuel oil						11.9													
	Plant 4	LRK <sup>(1)</sup>	ESP <sup>(4)</sup>	Coal, coke 05			56	6.5					94	7.2			3.8 <sup>(7)</sup>	12.6	336	8			
	Plant 5	PFRK <sup>(2)</sup>	Bag <sup>(5)</sup>	Coke gas																			
PFRK <sup>(2)</sup>		Bag <sup>(5)</sup>	Coke gas																				
Plant 6	PFRK <sup>(2)</sup>	Bag <sup>(5)</sup>	Regenerated fuel oil																			65 <sup>(8)</sup>	
<sup>(1)</sup> Long rotary kiln <sup>(2)</sup> Annular shaft kiln <sup>(3)</sup> Parallel flow regenerative kiln <sup>(4)</sup> Electrostatic precipitator <sup>(5)</sup> Fabric filter, textile <sup>(6)</sup> O <sub>2</sub> standard state										<sup>(7)</sup> O <sub>2</sub> ≥ 11 % <sup>(8)</sup> Excluded filter <sup>(9)</sup> Burned product: 310 t/d <sup>(10)</sup> NO <sub>2</sub> <sup>(11)</sup> NO Source: [63, Finland, 2006, 65, Finland, 2006]													

Table 6.37: Emissions of dust, NO<sub>x</sub>, SO<sub>x</sub>, CO and CO<sub>2</sub> from several Finnish lime plants using different types of lime kilns from 1998 to 2006

Emissions of metals		
Metal	Unit	Emissions (particles/gas formation)
Cd	$\mu\text{g}/\text{Nm}^3$	0.05/0.08
Ti	$\mu\text{g}/\text{Nm}^3$	0.30/<1.6
Hg	$\mu\text{g}/\text{Nm}^3$	0.001/0.026
Sb	$\mu\text{g}/\text{Nm}^3$	0.5/<1.6
As	$\mu\text{g}/\text{Nm}^3$	<0.2/1.9
Pb	$\mu\text{g}/\text{Nm}^3$	5.2/6.0
Cr	$\mu\text{g}/\text{Nm}^3$	0.7/15
Co	$\mu\text{g}/\text{Nm}^3$	0.14/1.3
Cu	$\mu\text{g}/\text{Nm}^3$	0.32/7.2
Mn	$\mu\text{g}/\text{Nm}^3$	3.6/6.0
Ni	$\mu\text{g}/\text{Nm}^3$	3.0/6.0
V	$\mu\text{g}/\text{Nm}^3$	<0.1/37

*Source: [65, Finland, 2006]*

**Table 6.38: Metal emissions from a Finnish lime plant**

### 6.3.3 Lime manufacturing – example for handling waste oil in a shaft kiln (OK)

In order to convert/change a gas-fired shaft kiln (OK) into a waste oil fired shaft kiln, it was necessary to modify the burners and to build a dedicated infrastructure for the unloading and storage of the waste oil.

As shown in Figure 6.26, in this specific case the waste oil is delivered to the lime plant either by rail or by road, e.g. in tank lorries. Two double walled storage tanks with a capacity of 100 m<sup>3</sup> each were erected. The waste oil is transferred from the wagons or from the lorries into the storage tanks which are located in a specially designed area to contain any spillage. Surface water (rainwater) is discharged to an oil separator. Since the filling area meets all relevant legal requirements, it is also used to clean and refuel all kinds of road and rail vehicles.

During the unloading of the wagons or tank lorries, the waste oil flows through a hosepipe connection and then through a steel pipe into a first pumping and filtering station. From there, it is pumped through underground double walled pipes into the two 100 m<sup>3</sup> tanks. At a kiln output of 250 to 300 t/lime/d, this storage capacity is roughly equivalent to one week's consumption.

From the tanks, the oil flows into a second pumping station as shown in Figure 6.27, which is located in the immediate neighbourhood of the kiln. A feeding pump conveys the oil to another filter and to an electric heating system, which heats the oil up to 60 – 80 °C. These temperatures are necessary to decrease the viscosity of the oil thus improving its atomisation in the burner and its optimal combustion. Ascending pipes lead the heated oil to a dosing and measuring station as shown in Figure 6.28, from where it is distributed to the individual burners. Within the burners, the fuel is mixed to air and both are directly injected into the kiln.

No waste is produced during the combustion of the filtered oil. Waste is only produced during the filtering process of the oil. The filters are cleaned, and any waste is collected in designated containers and safely disposed of [50, Germany, 2006], [51, EuLA, 2006].



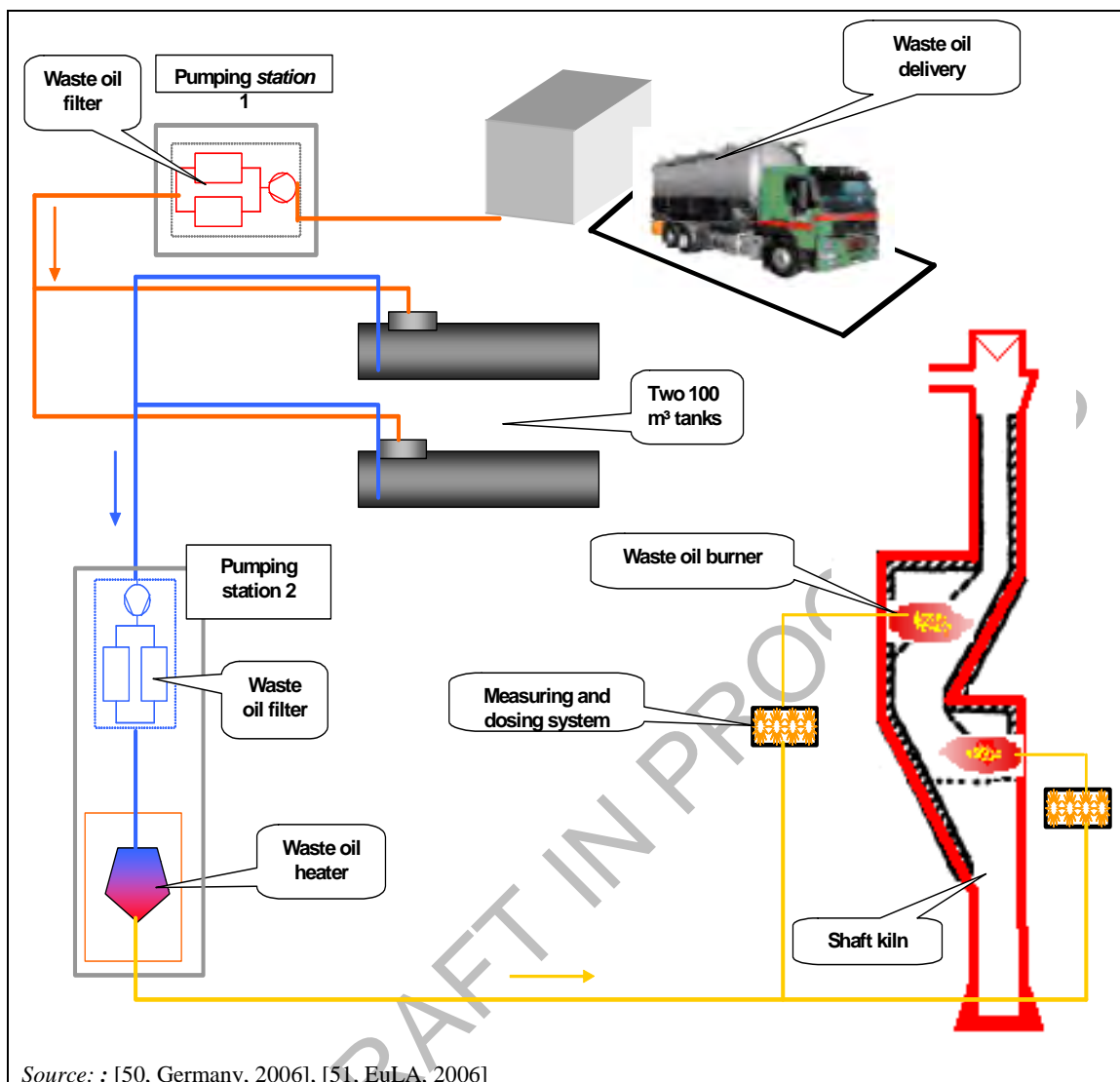


Figure 6.26: Flow diagram of waste oil circulation – going from delivery to the shaft kiln (OK)



Figure 6.27: Pumping station number 2 with a filter and a waste container for cleaning the filter

Source: [50, Germany, 2006], [51, EuLA, 2006]



Figure 6.28: Measuring and dosing station with pneumatic valves

Source: [50, Germany, 2006], [51, EuLA, 2006]

### 6.3.4 Lime manufacturing – example for quality control of solid waste fuels burned in rotary kilns

An example from a German lime plant shows typical requirements for solid wastes used in four preheater rotary kilns. These rotary kilns are equipped with cyclones and an ESP for reducing the dust emissions. Furthermore, the SNCR technique is used for NO<sub>x</sub> emissions reduction (see Section 6.3.5). In a rotary kiln, typical temperatures are in a range of between 1000 and 1400 °C.

The fuels used are pulverised lignite, natural gas and solid waste materials. Solid wastes are delivered by specialised waste collecting and blending companies. The permit allows a maximum of 60 % of the thermal capacity to be replaced by wastes. In 2006, the substitution rate by solid wastes was 10 %. Before feeding these solid waste fuels to the burner, the metallic parts are discharged by a magnetic separator.

The selection of waste types for using as fuels in a lime kiln depend on the technical requirements of the burning process and the product quality. In this example, waste fuels consist of solid refuse derived fuel (RDF) from selected wastes with low pollutant contents (mainly plastics) and well defined heating values. Their origin and waste classification according to the European Waste Catalogue (2000/532/EC) are exactly specified [98, European Commission, 2000]. Table 6.39 shows the type of waste that can be used in these rotary kilns [50, Germany, 2006], [51, EuLA, 2006]:

Waste code	General description
02 01 04	Waste plastics (except packaging)
02 01 07	Waste from forestry
03 01 01	Waste bark and wood
03 01 05	Sawdust, shavings, cuttings, wood, particle board and veneer other than those mentioned in 03 01 04
03 03 02	Green liquor sludge (from recovery of cooking liquors)
03 03 07	Mechanically separated rejects from pulping of waste paper and cardboard
03 03 08	Wastes from sorting of paper and cardboard destined for recycling
04 02 09	Wastes from composite materials (impregnated textile, elastomer, plastomer)
04 02 21	Wastes from unprocessed textile fibres
04 02 22	Wastes from processed textile fibres
07 02 13	Waste plastic
08 01 12	Waste paint and varnish except those mentioned in 08 01 11
08 02 01	Waste coating powders
09 01 07	Photographic film and paper containing silver or silver compounds
12 01 05	Plastic shavings and turnings
15 01 01 ÷ 03	Paper and cardboard, plastic, wooden packaging
15 01 05 ÷ 06	Composite and mixed packaging
15 02 03	Absorbents, filter materials, wiping cloths and protective clothing except those mentioned in 15 02 02
16 01 03	End-of-life tyres
17 02 01	Wood
17 02 03	Plastic
19 05 01	Non-composted fraction of municipal and similar wastes
19 12 01	Paper and cardboard
19 12 04	Plastic and rubber
19 12 07	Wood other than that mentioned in 19 02 06
19 12 08	Textiles
19 12 10	Combustible waste (refuse derived fuel)
<i>Source:</i> [50, Germany, 2006], [51, EuLA, 2006], [98, European Commission, 2000]	

**Table 6.39: List of wastes that can be used in these German lime kilns**

The quality requirements for solid wastes are determined by the permitting authority. For each delivery, the fuel suppliers have to confirm that the ready for use fuels only include the wastes mentioned in Table 6.39.

For the quality control of these fuels, waste fuels are divided into four categories, which define the range of net calorific values and the chemical composition.

Two statistical parameters shown in Table 6.40 are used for regulating the input of metals into the kiln:

- median value (= percentile 50 %) also called 'practical' value. It is based on the practical experience and takes into consideration the possible variations of the fuel composition
- maximal values (= percentile 100 %).

Pollutant	Waste fuel 1		Waste fuel 2		Waste fuel 3		Waste fuel 4	
	Median value (mg/kg)	Maximal value (mg/kg)	Median value (mg/kg)	Maximal value (mg/kg)	Median value (mg/kg)	Maximal value (mg/kg)	Median value (mg/kg)	Maximal value (mg/kg)
Mercury Hg	0.4	1.0	0.4	1.0	0.4	1.0	0.6	1.2
Cadmium Cd	4.0	15.0	4.0	15.0	4.0	10.0	4.0	9.0
Thallium Tl	1.0	5.0	1.0	5.0	1.0	5.0	1.0	2.0
Arsenic As	5.0	10.0	5.0	10.0	5.0	15.0	5.0	13.0
Cobalt Co	5.0	10.0	5.0	10.0	5.0	10.0	6.0	12.0
Nickel Ni	20.0	100.0	20.0	100.0	20.0	100.0	25.0	50.0
Antimony Sb	40.0	100.0	40.0	100.0	25.0	60.0	25.0	60.0
Lead Pb	40.0	100.0	40.0	100.0	40.0	100.0	70.0	200.0
Chrome Cr	40.0	100.0	40.0	100.0	40.0	100.0	40.0	120.0
Copper Cu	100.0	250.0	90.0	250.0	90.0	500.0	120.0	300.0
Manganese Mn	50.0	100.0	50.0	100.0	50.0	100.0	50.0	100.0
Vanadium V	10.0	20.0	10.0	20.0	10.0	20.0	10.0	25.0
Tin Sn	15.0	50.0	15.0	50.0	15.0	75.0	30.0	70.0
Total chlorine	7000.0	10000.0	7000.0	10000.0	7000.0	10000.0	7000.0	10000.0
Total fluorine	250.0	500.0	250.0	500.0	250.0	1000.0	250.0	1000.0
Beryllium Be	0.5	5.0	0.5	5.0	0.5	5.0	0.5	2.0
Zinc Zn	400.0	500.0	400.0	500.0	400.0	1000.0	400.0	1000.0
	% w/w <sup>(1)</sup>	% w/w <sup>(1)</sup>	% w/w <sup>(1)</sup>	% w/w <sup>(1)</sup>	% w/w <sup>(1)</sup>	% w/w <sup>(1)</sup>	% w/w <sup>(1)</sup>	w/w <sup>(1)</sup> %
Moisture	8.0	<10.0	11.0	<12.5	18.0	<20.0	18.0	<20.0
Ash content	6.0	<7.0	8.0	<9.0	11.0	<15.0	11.0	<15.0
Total sulphur	0.3	<0.5	0.3	<0.5	0.2	<0.3	0.2	<0.3
PCB		<3		<1		<1		<1

(<sup>1</sup>) Percentage by weight  
Source: [50, Germany, 2006] [51, EuLA, 2006]

**Table 6.40: Median and maximal concentrations of metals for each type of waste fuel**

For this example, ranges were defined for the net calorific values of each fuel category as shown in Table 6.41:

Net calorific value (MJ/kg)	Waste fuel 1		Waste fuel 2		Waste fuel 3		Waste fuel 4	
	Minimum	Maximum	Minimum	Maximum	Minimum	Maximum	Minimum	Maximum
	25	31	23	29	20	24	18	22

Source: [50, Germany, 2006], [51, EuLA, 2006]

**Table 6.41: Minimum and maximum net calorific values for each type of waste fuel**

Regular sampling of waste fuels is carried out. The individual samples are divided into sub samples, which are combined again later to a mixed sample. After predetermined time intervals, the mixed samples are checked to see if the quality requirements meet those that are indicated in Table 6.40.

By using waste as fuels, quality assurance and warranty is one of the most important issues. Table 6.42 illustrates examples of quality assurance techniques.

Process step	Techniques	Additional techniques
Source of waste (waste producer, sorting facility, mechanical-biological waste treatment)	<ul style="list-style-type: none"> <li>listing wastes</li> <li>avoiding impurities</li> <li>stipulations about acceptable qualities of individual waste types</li> <li>declaration analysis</li> <li>documentation of disposed quantity of individual waste types</li> </ul>	<ul style="list-style-type: none"> <li>instruction of the waste producer by the waste manager</li> <li>regular control of the plant producing waste by the waste manager</li> </ul>
Waste treatment plant	<ul style="list-style-type: none"> <li>(regular) sampling and analysis</li> <li>retain samples</li> <li>documentation of incoming and treated waste quantities</li> </ul>	<ul style="list-style-type: none"> <li>(regular) sampling and analysis of quantities of incoming treated waste by an external expert</li> </ul>
Waste treatment plant	<ul style="list-style-type: none"> <li>regular sampling and analysis</li> <li>retain samples</li> <li>documentation of outgoing waste quantities</li> </ul>	
Lime plant	<ul style="list-style-type: none"> <li>regular sampling and analysis</li> <li>retain samples</li> <li>documentation of incoming and waste quantities</li> </ul>	
<i>Source:</i> [156, Germany, 2007]		

**Table 6.42: Examples of techniques for the quality assurance of wastes**

### 6.3.5 Lime manufacturing – example of DeNO<sub>x</sub> treatment by using the SNCR technique in preheater rotary kilns (PRK)

At the Flandersbach plant (Germany), primary and secondary techniques were successively implemented for four preheater rotary kilns. A new burner was installed in one of the kilns, but its impact on the NO<sub>x</sub> emissions was quite limited. Practical experience has shown that the overall oxygen concentration in the burning zone had a much bigger influence on these emissions. Thus, the kiln atmosphere has been adjusted to lower the oxygen concentration. However, it appeared that this measure was not sufficient to ensure that the NO<sub>x</sub> emissions were always below 500 mg/Nm<sup>3</sup>. Especially when producing hard burned lime, the NO<sub>x</sub> emissions usually exceeded 1000 mg/Nm<sup>3</sup> (in stable kiln conditions) and sometimes 2000 mg/Nm<sup>3</sup>, e.g. when more cooling air was needed to avoid an overheating of the lime cooler.

Due to the temperature conditions below the Lepol grate, it is possible to reduce the NO<sub>x</sub> emissions by injecting reducing agents in this area. Therefore, preliminary tests with different liquids, injection locations and injection rates were carried out to optimise the design of the industrial SNCR installation, described as follows:

#### *General concept*

Liquid reducing agents are delivered by lorries and stored in two tanks. The liquid agent is then pumped to the Lepol grates, where it is sprayed in the hot chambers using pressurised air for the atomisation and mixing with the flue-gases. The facility is designed to handle ammonia water with concentrations of up to 25 %, and has to deal with the regulation of hazardous materials.

#### *Filling of the tanks*

The tank lorry is unloaded with a pump through a double walled, leakage-supervised hose pipe and a double filter to hold back contraries. The driver gets the clearance to unload after registration at the control room. The filling procedure is not started until the lorry tank is earthed. Refilling is automatically stopped when the tank is full or the differential pressure monitoring of the filters sends a maximum signal. New clearance must be requested by the tank lorry driver after switching to the other tank or to the second filter.

#### *Storage*

Two tanks, each with a volume of 80 m<sup>3</sup>, are equipped with safety and control devices, as well as circulation pumps. To avoid overpressure or vacuum, a pressure sensitive valve is installed at the tanks and the pressure in the tanks is monitored.

#### *Dosing*

For each Lepol grate, one pump controlled by a frequency converter is installed. Each dosing pump can operate alternatively from each of the two tanks. The pumps are equipped with a pressure relief valve to prevent an increase in pressure by a blocked system. One standby pump is installed in case of failure of one of the dosing pumps, to be switched to the respective injection point.

Additional supply ports allow the flushing of the piping and the filters with industrial water to empty the components, e.g. before maintenance.

The atomising nozzles have to be operated at their designated flowrates. To keep the optimal spraying conditions at the atomising nozzles, the flowrate in the dosing lines has to be controlled. If the flowrate drops below a preset value, e.g. when the need of the reducing agent is low, industrial water is added to the system to increase this value. This option also provides the possibility to store highly concentrated agents and dilute the agents to obtain good distribution in the flue-gas stream and therefore optimise efficiency. When the necessary flow of reducing agent increases, e.g. when the nitrogen concentration of the liquids is low and the needed reduction rate is high, a second lance is activated at the injection port. In the control system, the distinguishing of low and high concentration in the tanks is possible and different operation modes for the dosing are implemented.

All piping is isolated and equipped with trace heating to avoid freezing during winter time and crystallisation in the case of the use of liquid urea.

### *Injection location*

The location of the injection points was determined during tests in the Flandersbach plant. The chosen ports allow good penetration and mixing of the agent with the flue-gas at a location with little tendency to form coating which might disturb the injection. The connecting points are shown in Figure 6.29.

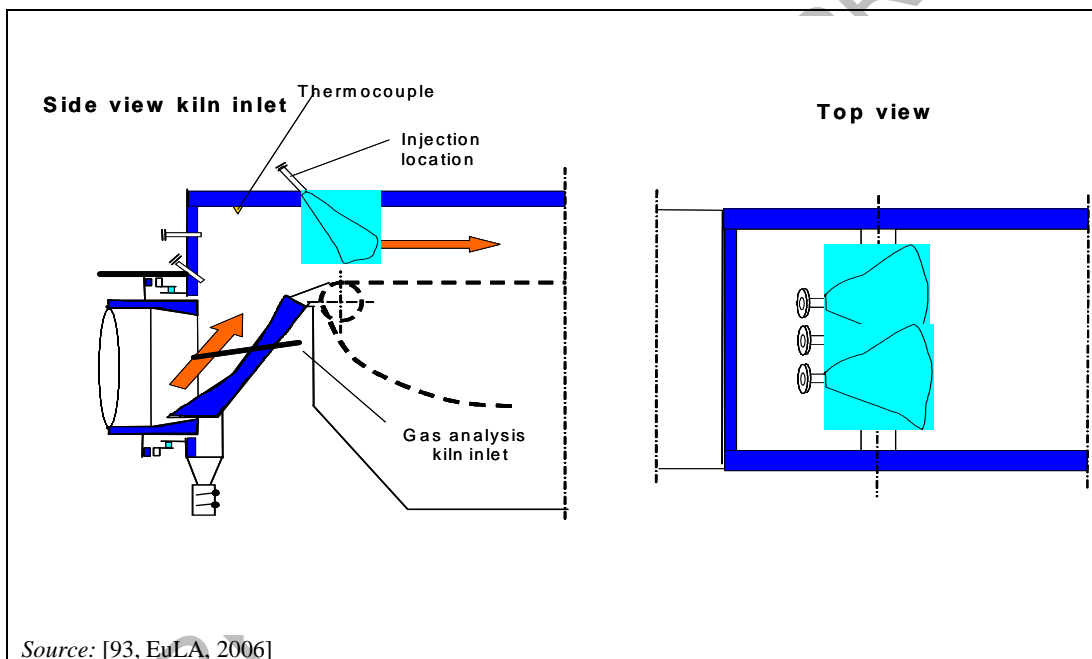


Figure 6.29: Location of injection and connecting points for SNCR in the Flandersbach lime plant in Germany

### *Operation*

The installation of the facility was completed in July 2006 and the start-up phase finished at the end of August 2006. Since then, the installation has been running without major trouble. Necessary improvements resulting from the experience made during start-up and operation since have been implemented.

*Abatement efficiencies*

Reduction efficiencies of 50 to 60 % appear to be possible, thus enabling the level of NO<sub>x</sub> emissions to remain below 500 mg NO<sub>x</sub>/Nm<sup>3</sup> as a daily average. Higher abatement ratios are, in principle, possible but they immediately lead to massive ammonia slips. Measurements carried out under different process and injection conditions have shown that the emissions of nitrous oxide (N<sub>2</sub>O) always remained below 10 mg/Nm<sup>3</sup>.

*Costs*

Investment costs are similar to those mentioned by the cement industry, i.e. between EUR 0.5 million and 1.2 million. Because the equipment has only been operational for a short time (few weeks), it is difficult to assess precisely the operating costs. Financial estimations based on the preliminary tests show that the operating costs could be similar to those reported by the cement industry, i.e. EUR 0.1 to 1.7 per tonne lime referring to a kiln capacity of 1000 t/day and initial emissions of up to 1500 mg NO<sub>x</sub>/Nm<sup>3</sup>.

WORKING DRAFT IN PROGRESS

---

WORKING DRAFT IN PROGRESS

---



## GLOSSARY

This glossary is meant to facilitate the understanding of the information contained in this document. The definitions of terms in this glossary are not legal definitions (even if some of them may coincide with definitions given in European legislations), they are meant to help the reader understand some key terms in the context of their use in the specific sector covered by this document.

This glossary is divided into the following sections:

- I. ISO country codes
- II. Monetary units
- III. Unit prefixes, number separators and notations
- IV. Units and measures
- V. Chemical elements
- VI. Chemical formulae commonly used in this document
- VII. Acronyms
- VIII. Technical terms

### I. ISO country codes

ISO code	Country / Organisation
EU	European Union
<i>Member States (°)</i>	
AT	Austria
BE	Belgium
BG	Bulgaria
CZ	Czech Republic
CY	Cyprus
DE	Germany
DK	Denmark
EE	Estonia
EL	Greece
ES	Spain
FI	Finland
FR	France
HU	Hungary
IE	Ireland
IT	Italy
LT	Lithuania
LU	Luxembourg
LV	Latvia
MT	Malta
NL	Netherlands
PL	Poland
PT	Portugal
RO	Romania
SE	Sweden
SI	Slovenia
SK	Slovakia
UK	United Kingdom
<i>Non-member countries</i>	
CA	Canada
CH	Switzerland
CN	China
JP	Japan
NO	Norway
US	United States

(°) The protocol order of the Member States is based on the alphabetical order of their geographical names in the original language(s).

## II. Monetary units

Code <sup>(1)</sup>	Country/territory	Currency
<i>Member State currencies</i>		
EUR	Euro area <sup>(2)</sup>	euro (pl. euros)
SEK	Sweden	krona (pl. kronor)
<sup>(1)</sup> ISO 4217 codes.		
<sup>(2)</sup> Includes Austria, Belgium, Cyprus, Estonia, Finland, France, Germany, Greece, Ireland, Italy, Luxembourg, Malta, the Netherlands, Portugal, Slovakia, Slovenia and Spain.		

## III. Unit prefixes, number separators and notations

Numbers in this document are written using the '.' character as the decimal separator and the space as the separator for thousands.

The symbol ~ (around; more or less) is the notation used to indicate approximation.

The symbol Δ (delta) is the notation used to indicate a difference.

The following table contains the frequently used prefixes:

Symbol	Prefix	10 <sup>n</sup>	Word	Decimal Number
T	tera	10 <sup>12</sup>	Trillion	1 000 000 000 000
G	giga	10 <sup>9</sup>	Billion	1 000 000 000
M	mega	10 <sup>6</sup>	Million	1 000 000
k	kilo	10 <sup>3</sup>	Thousand	1000
h	hecto	10 <sup>2</sup>	Hundred	100
da	deca	10 <sup>1</sup>	Ten	10
-----	-----	1	One	1
d	deci	10 <sup>-1</sup>	Tenth	0.1
c	centi	10 <sup>-2</sup>	Hundredth	0.01
m	milli	10 <sup>-3</sup>	Thousandth	0.001
μ	micro	10 <sup>-6</sup>	Millionth	0.000 001
n	nano	10 <sup>-9</sup>	Billionth	0.000 000 001
p	pico	10 <sup>-12</sup>	Trillionth	0.000 000 000 001

#### IV. Units and measures

Unit Symbol	Unit Name (comment)	Measure name (Measure symbol)	Conversion and comment
atm	normal atmosphere	Pressure (P)	1 atm = 101 325 N/m <sup>2</sup>
bar	bar	Pressure (P)	1.013 bar = 100 kPa = 1 atm
°C	degree Celsius	Temperature (T) temperature difference (ΔT)	
cSt	centistokes	Viscosity	
dB(A)	decibel	Sound (noise) levels	Sounds levels using a sound level filter with A scale (corresponding to the inverse of the 40 dB (at 1 kHz) equal-loudness curve)
d	day	Time	
g	gram	Weight	
h	hour	Time	
I-TEQ	international toxicity equivalent	Toxicity	
K	kelvin	Temperature (T) Temperature difference (ΔT)	0 °C = 273.15 K
kcal	kilocalorie	Energy	1 kcal = 4.1868 kJ
kg	kilogram	Weight	
kJ	kilojoule	Energy	
kWh	kilowatt-hour	Energy	1 kWh = 3600 kJ
m	metre	Length	
m <sup>2</sup>	square metre	Area	
m <sup>3</sup>	cubic metre	Volume	
mg	milligram	Weight	1 mg = 10 <sup>-3</sup> g
min	minute		
m/min	metre/minute	Speed	
m <sup>3</sup> /h	cubic metre per hour	Volume flow	if not otherwise mentioned in this document, the volume flows refer to 10 vol-% oxygen and standard state
mg/m <sup>3</sup>	milligram per cubic metre	Concentration	if not otherwise mentioned in this document, the concentrations of gaseous substances or mixtures of substances refer to dry flue-gas at 10 vol-% oxygen and standard state
mm	millimetre	Length	1 mm = 10 <sup>-3</sup> m
mmWG	millimetre water gauge	Pressure (P)	
Mt	megatonne	Weight	1 Mt = 10 <sup>6</sup> tonne
MJ	megajoule	Energy	1 MJ = 1000 kJ = 10 <sup>6</sup> joule
µm	micrometre	Length	1 µm = 10 <sup>-6</sup> m
MW	megawatts	Energy	
ng	nanogram	Weight	1 ng = 10 <sup>-9</sup> gram
Nm <sup>3</sup>	normal cubic metre	Volume	at 101.325 kPa, 273.15 K
ppm	parts per million	Composition of mixtures	1 ppm = 10 <sup>-6</sup>
t	metric tonne	Weight	1 t = 1000 kg or 10 <sup>6</sup> g
vol-% % v/v	percentage by volume	Composition of mixtures	
wt-% % w/w	percentage by weight	Composition of mixtures	
W	watt	Power	1 W = 1 J/s
yr	year	Time	
Ω cm	Ohm centimetre	Specific resistance	

## V. Chemical elements

Symbol	Name	Symbol	Name
Ag	Silver	N <sub>2</sub>	Nitrogen
Al	Aluminium	Na	Sodium
As	Arsenic	Ni	Nickel
Ba	Barium	Pb	Lead
Be	Beryllium	Pd	Palladium
Ca	Calcium	Pt	Platinum
Cd	Cadmium	Rh	Rhodium
Co	Cobalt	Sb	Antimony
Cr	Chromium	Se	Selenium
Cu	Copper	Sn	Tin
F	Fluorine	Te	Tellurium
Fe	Iron	Ti	Titanium
Hg	Mercury	Tl	Thallium
Mn	Manganese	V	Vanadium
Mo	Molybdenum	Zn	Zinc

## VI. Chemical formulae commonly used in this document

Chemical formula	Name (explanation)
Al <sub>2</sub> O <sub>3</sub>	Aluminium oxide
CaCO <sub>3</sub>	Calcium carbonate
CaO	Calcium oxide
Ca(OH) <sub>2</sub>	Calcium hydroxide
CaMg(OH) <sub>4</sub>	Calcium magnesium hydroxide
CH <sub>4</sub>	Methane
CN	Cyanide
CO	Carbon monoxide
CO <sub>2</sub>	Carbon dioxide
Fe <sub>2</sub> O <sub>3</sub>	Iron oxide
HCl	Hydrochloric acid
HF	Hydrofluoric acid
H <sub>2</sub> O	Water
H <sub>2</sub> S	Hydrogen sulphide
KOH	potassium hydroxide
MgCO <sub>3</sub>	Magnesium carbonate
MgO	Magnesium oxide/magnesia
N <sub>2</sub>	Nitrogen
NH <sub>3</sub>	Ammonia
NH <sub>4</sub>	Ammonium
NO	Nitrogen monoxide
NO <sub>2</sub>	Nitrogen dioxide
NO <sub>x</sub>	Nitrogen oxides
O <sub>2</sub>	Oxygen
SiO <sub>2</sub>	Silicon oxide
SO <sub>2</sub>	Sulphur dioxide
SO <sub>3</sub>	Sulphur trioxide
SO <sub>x</sub>	Sulphur oxides

## VII. Acronyms

<b>ADEME</b>	Agence de l'Environnement et de la Maitrise de l'Energie
<b>AFR</b>	Alternative fuels and raw materials
<b>ASK</b>	Annular shaft kiln
<b>ATILH</b>	Association Technique de l'Industrie des Liant Hydrauliques
<b>AWDF</b>	Agricultural waste derived fuels
<b>BUWAL</b>	Bundesamt für Umwelt, Wald und Landschaft, Switzerland
<b>CAS #</b>	Chemical Abstract Service registry number; division of the American Chemical Society; link to a wealth of information about a specific chemical substance; unique numerical identifier for chemical compounds, polymers, biological sequences, mixtures and alloys which designates only one substance
<b>CCM</b>	Caustic calcined magnesia/causter
<b>CEMS</b>	Continuous Emissions Monitors
<b>CEN/TC 343</b>	European Committee for Standardisation Working group CEN/TC 343 'Solid Recovered Fuels' with mandate of the European Commission to develop and produce all necessary standards on solid recovered fuels (SRF), such as technical specification which will be transformed into standards (European Norms (EN) after validation
<b>CKD</b>	Cement kiln dust
<b>DBM</b>	Dead burned magnesia
<b>EC#</b>	refers to the seven-digit code (sometimes called the EC number) that has been allocated by the Commission of the European Communities for commercially available chemical substances within the European Union. EC# designation replaced EINECS and ELINCS designations, and this code includes those on the so-called 'no longer polymers list', a list of substances that were on the European market between 18 September 1981 and 31 October 1993 and at the time were regarded as polymers, but are no longer regarded as such
<b>EEA</b>	European Environment Agency
<b>EFTA</b>	European Free Trade Association (established on 3 May 1960)
<b>EGTEI</b>	Expert Group on Techno-Economic Issues
<b>EINICS</b>	European inventory of existing commercial chemical substances; registry number given to each chemical substance commercially available in the European Union between 1 January 1971 and 18 September 1981. The inventory has been replaced by ELINCS
<b>ELINCS</b>	As from 19 September 1981, the European inventory list of notified chemical substances was replaced by ELINCS. All 'new' substances brought to the European market are allocated an ELINCS number after their notification to the European Commission
<b>eqC</b>	equivalent carbon
<b>EPA</b>	Environmental Protection Agency
<b>ESP</b>	Electrostatic precipitator
<b>EU</b>	European Union
<b>EU-15</b>	Member states of the European Union before 1 may 2004
<b>EU-25</b>	Member states of the European Union from 1 may 2004 until 31 december 2006
<b>EU-27</b>	Member states of the European Union from 1 january 2007
<b>EU-23+</b>	Refers to Cembureau's member countries: Austria, Belgium, Croatia, the Czech Republic, Denmark, Estonia, Finland, France, Germany, Greece, Hungary, Ireland, Italy, Latvia, Luxembourg, the Netherlands, Norway, Poland, Portugal, Romania, Slovenia, Spain, Sweden, Switzerland, Turkey and the United Kingdom
<b>EURITS</b>	European Union for Responsible Incineration and Treatment of Special Waste

<b>EWC</b>	European Waste Catalogue – hierarchical list of waste descriptions. This catalogue classifies waste materials and categorises them according to how they were produced and what their characteristics are. The EWC is referred to in a number of EU Directives and Commission Decisions regarding waste management
<b>FGD</b>	Flue-gas desulphurisation
<b>FGT</b>	Flue-gas treatment
<b>FM</b>	Fused magnesia
<b>GAINS</b>	Greenhouse Gas and Air Pollution Interactions and Synergies model
<b>GSC</b>	Gas suspension calcination
<b>IPCC</b>	Intergovernmental Panel on Climate Change
<b>IUPAC</b>	International Union of Pure and Applied Chemistry nomenclature
<b>L.O.I./LOI</b>	Loss on ignition, technique for the determination of, e.g. organic matter, carbonate, CO <sub>2</sub>
<b>LRK</b>	Long rotary kiln
<b>MFSK</b>	Mixed feed shaft kiln
<b>MSW</b>	Municipal solid waste
<b>NVC</b>	(Net) calorific value
<b>OECD</b>	Organisation for Economic Co-operation and Development
<b>OECD MIX</b>	Primary energy mix from OECD countries
<b>OK</b>	Other kilns
<b>ORC</b>	Organic Rankine Cycle
<b>OSK</b>	Other shaft kiln
<b>PCB</b>	Polychlorinated biphenyls
<b>PCC</b>	Precipitated calcium carbonate
<b>PCDD</b>	Polychlorinated dibenzo-p-dioxin
<b>PCDF</b>	Polychlorinated dibenzofuran
<b>PCP</b>	Pentachlorophenol
<b>PCT</b>	Polychlorinated terphenyls
<b>PET</b>	Polyethylene terephthalate
<b>PF</b>	Pulverised fuel
<b>PFRK</b>	Parallel flow regenerative kiln
<b>PLC</b>	Programmable logic controller: digital computer used for automatisisation of industrial processes
<b>PM</b>	Particulate matter
<b>POPS</b>	Persistent organic pollutants
<b>PRK</b>	Rotary kiln with preheater
<b>PTFE</b>	Polytetrafluoroethylene
<b>PVC</b>	Polyvinyl chloride
<b>RAINS</b>	Regional Air Pollution Information and Simulation model
<b>RDF</b>	Refuse derived fuel; waste fuel derived from pretreated and sorted waste fractions
<b>RK</b>	Rotary kiln
<b>ROK</b>	Run-of-kiln
<b>SCR</b>	Selective catalytic reduction
<b>SEM</b>	Scanning electron micrograph
<b>SK</b>	Shaft kiln
<b>SNCR</b>	Selective non-catalytic reduction
<b>TCDD</b>	Tetrachlorodibenzodioxin
<b>TEQ</b>	International toxicity equivalents (dioxins and furans)
<b>TOC</b>	Total organic carbon
<b>UBA</b>	Technical working group
<b>UNFCCC</b>	Umweltbundesamt/Federal Environmental Agency
<b>VDZ</b>	United Nations Framework Convention on Climate Change
<b>VOC</b>	Verein Deutscher Zementwerke/German Cement Association
<b>WDF</b>	Volatile organic compounds

## VIII. Technical Terms

<b>alloy</b>	a metal that is a combination, either in solution or compound, of two or more elements, at least one of which is a metal, and where the resulting material has metallic properties
<b>calorific value</b>	expressed in this document as net calorific value
<b>causter</b>	caustic calcined magnesia/CCM
<b>chalk</b>	amorphous type of calcium carbonate
<b>channelled emissions</b>	emissions of pollutants into the environment through any kind of pipe, regardless of the shape of its cross-section [151, European Commission, 2003]
<b>CL 70 – 80</b>	classification standard: CL 70 = lime defined in EN 459 ‘Building lime’ with a content of CaO + MgO > 65 % CL 80 = lime defined in EN 459 ‘Building lime’ with a content of CaO + MgO > 75 %
<b>diagenesis</b>	the physical, chemical or biological processes that turn sediment into sedimentary rock by modifying the mineralogy and/or texture
<b>diffuse emissions</b>	emissions arising from direct contact of volatile or light dusty substances with the environment (atmosphere, under normal operating circumstances). These can result from: <ul style="list-style-type: none"> <li>• inherent design of the equipment (e.g. filters, dryers, etc.)</li> <li>• operating conditions (e.g. during transfer of material between containers)</li> <li>• type of operation (e.g. maintenance activities)</li> <li>• or from a gradual release to other media (e.g. to cooling water or waste water) [151, European Commission, 2003]</li> </ul> Fugitive emissions are a subset of diffuse emissions.
<b>diffuse emissions sources</b>	sources of similar diffuse or direct emissions which are multiple and distributed inside a defined area; they can be point, linear, surface or volume sources [151, European Commission, 2003]
<b>DL 80 – 85</b>	classification standard: DL 80 = dolime defined in EN 459 ‘Building lime’ with a content of CaO + MgO > 75 % DL 85 = dolime defined in EN 459 ‘Building lime’ with a content of CaO + MgO > 80 %
<b>dolomite</b>	type of limestone the carbonate fraction of which is dominated by the mineral dolomite, calcium magnesium carbonate (CaMg(CO <sub>3</sub> ))
<b>exhaust gas</b>	off-gas from firing/combustion processes
<b>existing plant</b>	<b>a plant which is not a new plant</b>
<b>flue-gas</b>	off-gas/exhaust gas from firing/combustion processes
<b>fuel oil EL</b>	fuel oil extra light
<b>fugitive emissions</b>	emissions caused by non-tight equipment/leak: emissions into the environment resulting from a gradual loss of tightness from a piece of equipment designed to contain an enclosed fluid (gaseous or liquid), basically caused by a difference of pressure and a resulting leak. Examples of fugitive emissions: leak from a flange, a pump, a sealed or tightened equipment, etc. [151, European Commission, 2003]
<b>hydrated lime</b>	calcium hydroxide, Ca(OH) <sub>2</sub>
<b>immission</b>	occurrence and level of polluting substance, odours or noise in the environment
<b>leak air</b>	air, which arrives by leakages into the kiln
<b>limestone</b>	mineral rock consisting merely of CaCO <sub>3</sub> used as CaCO <sub>3</sub> or as raw material to produce quicklime (calcium oxide) by decarbonisation and hydrated lime (calcium hydroxide) by the hydration of quicklime
<b>magnesia</b>	magnesium oxide (MgO)
<b>magnesite</b>	magnesium carbonate (MgCO <sub>3</sub> )
<b>magnesium oxide</b>	MgO/magnesia
<b>major upgrade</b>	<b>An upgrade of the plant/kiln involving a major change in the kiln requirements or technology, or replacement of the kiln</b>
<b>morphology</b>	study of the structure and shape of particles

Glossary

<b>new plant</b>	A plant introduced on the site of the installation following the publication of the CLM BAT conclusions or a complete replacement of a plant on the existing foundations of the installation following the publication of the CLM BAT conclusions
<b>podsol</b>	bleaching clay
<b>pozzolana</b>	pozzolanas are materials that, though not cementitious in themselves, contain silica (and alumina) in a reactive form able to combine with lime in the presence of water to form compounds with cementitious properties. Natural pozzolana is composed mainly of a fine, chocolate-red volcanic earth. An artificial pozzolana has been developed that combines a fly ash and water-quenched boiler slag
<b>pozzolanic cement</b>	pozzolanic cements are mixtures of Portland cement and a pozzolanic material that may be either natural or artificial. The natural pozzolanas are mainly materials of volcanic origin but include some diatomaceous earths. Artificial materials include fly ash, burned clays, and shale
<b>quicklime</b>	calcium oxide, CaO
<b>siliceous limestone</b>	limestone that contains silicon dioxide (SiO <sub>2</sub> )
<b>sintered dolime</b>	A mixture of calcium and magnesium oxides (CaO >58% and MgO >41%) used solely for the production of refractory materials, with a minimum bulk density of 3.05 g/cm <sup>3</sup>
<b>special cement</b>	Products that fall under the PRODCOM code: <ul style="list-style-type: none"> <li>• 26.51.12.50 – Alumina cement</li> <li>• 26.51.12.90 – Other hydraulic cements</li> </ul>
<b>spot measurement</b>	sampling of spots, not a continuous measurement
<b>standard conditions for the cement and magnesium oxide industries</b>	referring to a temperature of 273.15 K and a pressure of 1013 hPa and oxygen content of 10 %
<b>standard conditions for the lime industry</b>	referring to a temperature of 273.15 K and a pressure of 1013 hPa and oxygen content of 11 %
<b>standard state</b>	referring to a temperature of 273.15 K and a pressure of 1013 hPa
<b>StDev</b>	standard deviation
<b>t60</b>	reactivity of lime; indicates the time needed for quicklime to be heated from 20 to 60 °C when reacting with water
<b>ultra low carbon dolime</b>	A mixture of calcium and magnesium oxides produced by the nearly full decarbonation of dolomite (CaCO <sub>3</sub> .MgCO <sub>3</sub> ). The residual CO <sub>2</sub> content of the product is below 0.25% and the bulk density well below 3.05 g/cm <sup>3</sup>
<b>white cement</b>	Products that fall under the PRODCOM code: <ul style="list-style-type: none"> <li>• 26.51.12.10 – White Portland cement</li> </ul>



---

**REFERENCES**

- 3 Austria, U. (1997). "Basic criteria for BAT cement/Information for cement and lime BREF 2001", UBA-IB-560 September 1997.
- 4 Austria, U. (1998). "BAT bei Anlagen zur Zementherstellung M-105 (1998) / Information for cement and lime BREF 2001", M-105 (1998).
- 8 CEMBUREAU (2001). "Information for cement industry/Information for cement and lime BREF 2001".
- 9 CEMBUREAU (1997 November). "BAT for the cement industry, November 1997 / Information for cement and lime BREF 2001".
- 10 Cementa AB/Hagström, P. (1994). "Underlag för omprövning av utsläppsvillor / Information for reconsideration and updating of permit conditions 1994 obtained during a plant visit 1997 and information communicated at other occasions / Information for cement and lime BREF 2001".
- 11 Coulburn, D. (2001). "Information for cement and lime BREF 2001".
- 12 Netherlands (1997). "Dutch notes on BAT for the production of cement clinker/Information for cement and lime BREF 2001".
- 16 EuLA (2001). "Information for cement and lime BREF 2001".
- 18 Göller (2001). "Information for cement and lime BREF 2001".
- 19 Haugh (2001). "Information for cement and lime BREF 2001".
- 20 Rother, W. (1996 January,). "International Cement Review/Exhaust gas emissions/Available control technology for gaseous emissions in cement plants / Information for cement and lime BREF 2001".
- 21 BCA (1997 October). "International Cement Review/Information for cement and lime BREF 2001".
- 22 Japan, C. A. (1996). "Information for cement and lime BREF 2001".
- 23 de Jonge, L. (2001). "Information for cement and lime BREF 2001".
- 24 Junker, P. (2001). "Information for cement and lime BREF 2001".
- 27 University of Karlsruhe, G. (1996). "Emission Control at Stationary Sources in the Federal Republic of Germany - Volume II, Heavy Metal Emission Control (August 1996), (UBA Research report 104 02 360 (January 1997))", UBA Research report 104 02 360 (January 1997).
- 29 Lohse, J. (2001). "Information for cement and lime BREF 2001".
- 30 Marchal, F. (2001). "Information for cement and lime BREF 2001".
- 31 LUA NRW, G. (1997). "LUA-Materialien No. 43, Identification of Relevant Industrial Sources of Dioxins and Furans in Europe, The European Dioxin Inventory, (1997)".

## References

---

- 37 UK (1996). "UK IPC Note: Cement Manufacture, Lime Manufacture and Associated Processes, IPC Guidance Note S2 3.01 (1996) / Information for cement and lime BREF 2001".
- 38 UK (1996). "Technical and Economic Review of Cement and Lime Processes (1996), Contract Ref: HMIP/CPR2/41/197 / Information for cement and lime BREF 2001".
- 39 Ullmann's (1986). "Ullmann's Encyclopedia of Industrial Chemistry, 5th edition, Vol. A 5, 489-537 (1986), Cement and Concrete / Information for cement and lime BREF 2001".
- 40 Ullmann's (1990). "Ullmann's Encyclopedia of Industrial Chemistry, 5th edition, Vol. A 15, 317-345 (1990), Lime and Limestone / Information for cement and lime BREF 2001".
- 41 Kupper/Brentrup (1992). "SNCR technology for NO<sub>x</sub> reduction in the cement industry, World Cement, p. 4-8, March 1992 / Information for cement and lime BREF 2001".
- 42 Billhardt/Kuhlmann/Ruhland/Schneider/Xeller (1996 October). "Current state of NO<sub>x</sub> abatement in the cement industry/Information for cement and lime BREF 2001", ZKG International, Volume 49, No. 10, p. 545-560, (1996).
- 43 Wulf-Schnabel/Lohse (1998). "Economic evaluation of NO<sub>x</sub> abatement techniques in the European Cement Industry, Report compiled for DG XI, Contract N° B4-3040/98/000232/MAR/E1 / Information for cement and lime BREF 2001".
- 44 EuLA (2006). "Draft lime sector Chapter 2.1 and 2.2".
- 45 Schorcht, F. (2006). "Personal Communication by site visits".
- 46 Germany (2006). "German contribution part I: Lime manufacturing industries", Compilation by German National Working group and German lime industry.
- 47 European Commission (2004). "Reference Document on Best Available Technique for Management of Tailings and Waste-Rock in Mining Activities".
- 48 European Commission (2005). "Reference Document on Best Available Techniques for Management of the Waste Treatments Industries".
- 49 European Commission (2000). "European waste catalogue", 2000/532/EC2, (2001/573/EC).
- 50 Germany (2006). "German contribution: Use of alternative fuels in lime manufacturing", Compilation by German National Working group and German lime industry.
- 51 EuLA (2006). "Use of alternative fuels in lime manufacturing".
- 53 Norsk Hydro Norway (2001). "Performance figures for a gas suspension calcination lime plant (GSC plant)".
- 54 EuLA (2006). "Draft lime sector Chapter 2.3 and 2.4 and additional information on these chapters".
- 55 Spain (2006). "Energy consumption by various types of lime kilns".
- 56 EuLA (2006). "Metals database EuLA".

- 57 European Commission (2005). "Reference Document on Best Available Techniques for Waste Incineration Industries".
- 58 European Commission (2003). "Reference Document on Best Available Technique for Common Waste Water and Waste Gas Treatment/Management Systems in the Chemical Sector".
- 59 European Union (2000). "Directive 2000/76/EC of the European Parliament and of the Council of 4 December 2000 on the incineration of waste", 2000/76/EC.
- 60 VDI 2094 Germany (2003). "Emissionsminderung Zementwerke/Emission control cement industry, VDI 2094, March 2003".
- 61 France (2006). "Cost calculation regarding abatement techniques in lime industry (ESP, fabric filter, deduster)", contribution for review.
- 62 France/DFIU/IFARE Karlsruhe (2004). "EGTEI - Draft background document on lime sector".
- 63 Finland (2006). "Contributions: Information and emissions from Finnish cement and lime plants".
- 64 Czech Republic (2006). "The lime industry in the Czech Republic".
- 65 Finland (2006). "Template Emission components - Saxo Mineral Finland - lime".
- 66 Austria (2006). "The Austrian lime industry".
- 67 Austria (2006). "Plant visit report Austria May 2006".
- 68 EuLA (2006). "Database emissions lime manufacturing".
- 70 Hungary (2006). "Raw material characteristics from Labatlan lime plant in Hungary".
- 71 Hungary (2006). "Information regarding Hungarian lime industry and measurements".
- 72 CEMBUREAU (2006-2008.). "General information about cement industry, updates 2006, 2007 and 2008".
- 73 CEMBUREAU (2006). "Existing national and international legislation and emission limits".
- 74 CEMBUREAU (2006). "2004 and 2005 statistics on the use of alternative fuels and materials in the clinker production in the European cement industry".
- 75 Estonia (2006). "Review to BREF for Kunda, cement manufacturing and annexes".
- 76 Germany, V. (2006). "Cement manufacturing industries, German contribution".
- 78 E. Baatz + G. Heidt (2000). "First waste heat power generating plant using the Organic Rancine Cycle Process for utilizing residual clinker cooler exhaust air".
- 79 Germany (2001). "Niedertemperaturverstromung mittels einer ORC-Anlage im Werk Lengfurt der Heidelberger Zement AG, Messergebnisse".
- 80 Alvaro A. Linero (2006). "Trip report on SCR experiences at Solnhofer Portland Zementwerke, Cementeria de Monselice and ASM Brescia waste-to energy plant".

## References

---

- 81 Castle Cement UK (2006). "Presentations and contributions from British cement plants during site visits".
- 82 CEMEX Rugby UK (2006). "Presentations and contributions from British cement plants during site visits".
- 83 CEMBUREAU (2006). "Guideline on CO trips".
- 84 CEMBUREAU (2006). "Specific energy consumption".
- 85 CEMBUREAU (2006). "Contributions on NO<sub>x</sub> abatement".
- 86 EURITS (2006). "Contribution: Template for the review of the cement and lime BREF".
- 87 European Commission (2001). "Reference Document on Best Available Technique on the Production of Iron and Steel".
- 88 SINTEF (2006). "Formation and Release of POPs in the Cement Industry".
- 89 ERFO, T., Glorius, Scoribel, (2005). "Classification of solid recovered fuels".
- 90 Hungary (2006). "Hungarian cement industry".
- 91 CEMBUREAU (2006). "Air emissions and alternative fuels in the European cement industry".
- 92 Austria (2006). "Austrian cement industry", Contribution with Annexes 1,2 and 3.
- 93 EuLA (2006). "NO<sub>x</sub> abatement in the lime industry".
- 94 European Union (2004). "Directive 2004/8/EC of the European Parliament and the Council of 11 February 2004 on the promotion of cogeneration based on a useful heat demand in the integral energy market and amending Directive 92/42/EEC".
- 95 Sweden (2006). "SNCR principle of selective non-catalytic reduction of nitrogen oxides (NO, NO<sub>x</sub>)".
- 96 European Commission (2006). "Reference Document on Best Available Technique on emissions from storage of bulk or dangerous materials".
- 97 CEMBUREAU (2007). "Behaviour of SO<sub>2</sub> in the clinker burning process".
- 98 European Commission (2000). "Commission Decision 2000/532/EC of 3 May 2000 replacing Decision 94/3/EC establishing a list of wastes pursuant to Article 1(a) of Council Directive 75/442/EEC on waste and Council Decision 94/904/EC establishing a list of hazardous waste pursuant to Article 1(4) of Council Directive 91/689/EEC on hazardous waste (notified under document number C(2000) 1147) (Text with EEA relevance)".
- 99 European Union (2003). "Directive 2003/87/EC of the European Parliament and the Council of 13 October 2003 establishing a scheme for greenhouse gas emission allowance trading within the Community and amending Council Directive 96/61/EC".
- 100 France (2006). "Cost calculation regarding abatement techniques in cement industry (ESP, bag filter, deduster, SNCR, NO<sub>x</sub> primary technologies, absorbent injection, wet scrubber)", contribution for review.

- 101 France/ADEME/MEDD (2002). "The French Cement Industry Guide to NO<sub>x</sub> Emission reduction Measures", contribution for review.
- 102 France/DFIU/IFARE Karlsruhe (2003). "EGTEI - Draft background document on cement sector", contribution for review.
- 103 CEMBUREAU (2006). "Additional contributions, e.g. types of cement and composition, information on chromates, information on why the cement industry has started to use AFR, contributions to the pre-draft of the revised CL BREF, composition information for grey cement", contribution for BREF review.
- 104 HOLCIM/GTZ (2006). "Guidelines on Co-processing Waste Materials in Cement Production".
- 105 YARA, M. R. L. (2006). "Contribution on cement industry, NO<sub>x</sub> abatement".
- 107 Belgium (2006). "Presentations and contributions from Belgium cement plant in Lixhe during site visit".
- 108 European Commission (2006). "Reference Document on Best Available Technique for the Manufacture of Large Volume Inorganic Chemicals - Solids and Others Industry (LVIC-S): Chapter 7.7 Magnesium compounds".
- 109 RHI AG (2006). "Magnesia production from magnesite (natural process)".
- 110 Spanish MgO producers (2006/2008). "Magnesia production from magnesite (natural process) and information regarding CO, noise emissions and sulphur content in the raw materials as well as additional information regarding dust emission levels achieved in a Spanish MgO plant by using fabric filters".
- 111 European Union (2003). "Directive 2003/53/EC of the European Parliament and of the Council of 18 June 2003 amending the 26th time Council Directive 76/769/EEC relating to restrictions on the marketing and use of certain dangerous substances and preparations (nonylphenol, nonylphenol ethoxylate and cement)".
- 112 Czech Republic (2006). "The cement industry in the Czech Republic".
- 113 Ireland (2007). "Report of PM 10's and PM 2.5's from air emission point".
- 114 Sweden (2006). "SNCR technique and NO<sub>x</sub> emissions in Swedish cement plants".
- 116 France (2002). "The French Cement Industry Guide to NO<sub>x</sub> Emission Reduction Measures".
- 117 Germany (2000). "Grundsatzuntersuchung über die Ermittlung der Korngrößenverteilung im Abgas verschiedener Emittenten".
- 118 Germany (2007). "Additional contributions regarding cement production, e.g. white cement manufacture, dedusting cement kilns with fabric filters, surface filters, sintered lamella filters".
- 119 Sobolev, K. (2001). "White cement: Problems of production and quality", Cement and Concrete World, Turkey, pp. 34-42.
- 120 Spain (2007). "Information on white cement production".

## References

---

- 122 European Commission (2004). "Commission's Decision of 29 January 2004 establishing guidelines for the monitoring and reporting of greenhouse gas emissions pursuant to Directive 2003/87/EC of the European Parliament and of the Council".
- 123 Ireland (2005). "Contributions regarding summary statement following short term SNCR trials at Limerick Works of Irish Cement".
- 124 European Commission (2001). "Reference Document on the Best Available Technique in the Pulp and Paper Industry".
- 125 European Commission (2006). "Reference Document on the Best Available Technique in the Food, Drink and Milk Industry".
- 126 Oates, J. A. H. (1998). "Lime and Limestone: Chemistry and Technology, Production and Uses", ISBN-10: 3527295275/ ISBN-13: 978-3527295272.
- 127 Portugal (2007). "Portuguese Natural Hydraulic Lime Plants - volatile organic carbon emissions".
- 128 Portugal (2007). "Portuguese Natural Hydraulic Lime Plants - carbon monoxide emissions".
- 129 EuLA (2006). "Database emissions from lime kilns".
- 130 Drnek/Maier (2007). "The impact of environmental legislation on the economics of magnesia production".
- 131 YARA, M. R. L. (2007). "Contribution on cement and lime industries, SNCR in cement and lime production - reducing agents".
- 132 CEMBUREAU/Federhen (2007). "Contribution: Dry scrubber".
- 133 CEMBUREAU/Federhen (2007). "Co-generation of power from waste heat".
- 134 CEMBUREAU/Federhen (2007). "Technical application of fibres in cement manufacturing process and cement works".
- 135 CEMBUREAU/Federhen (2007). "Contribution: Hybrid dust collector".
- 136 European Commission, C., March Consulting Group, MAIN Management e Ingeneria Consultores (1993). "Energy Technology in the Cement Industrial Sector", Final Report, Contract No XVII/4.1000/E/91-16.
- 137 Klein/Hoenig (2006). "Model calculation of the fuel requirement for the clinker burning process", Cement International, reprint from 3/2006, FIZ 2006, pp. 44-63.
- 138 Italy (2007). "Raw materials for white clinker production in Italy".
- 139 Italy (2007). "Italian lime production".
- 140 Italy (2007). "Cement plant-Monselice Cement Works, SCR installation".
- 141 Leibacher/Bellin/Linero (2007). "High dust SCR succeeds at Cementeria di Monselice".
- 142 EnvNGO/Tebert (2007). "CO-Minderung bei Kalköfen".
- 143 Williams, P. T. (2005). "Waste Treatment Disposal", 0470849126.

- 144 Adlhoch, H.-J. (1996). "Sinterlamellenfilter in der Zementindustrie", ZKG International, Nr. 10/1996., pp. 594-601.
- 145 Leibinger/Köberl (2001). "Neuartiges Energie-Minimierungskonzept für Ofenfilter in der Zementindustrie", ZKG International, No. 11/2001, pp. 618-629.
- 146 Leibinger/Neumann (2003). "Kostenreduktion durch höheres Leistungspotential bei Prozessfiltern in der Zementindustrie", ZKG International, No. 2/2003, pp. 44-52.
- 147 Marmor/Petzold (2006). "Wirtschaftliche Entstaubung mit Oberflächenfiltern, Teil 3", ZKG International, No. 10/2006, pp. 82-87.
- 148 Reitemeier (2005). "Neue Hochleistungs-Entstaubungsanlagen im Holcim-Zementwerk Dudfield", ZKG International, No. 8/2005, pp. 75-79.
- 149 CEN/EN 197-1 (2000). "Cement-Part 1: European Norm on composition, specifications and conformity criteria for common cements".
- 150 Fabrellas/Larrazabal/Martinez/Sanz/Ruiz/Abad/Rivera (2004). "Global Assessment of PCDD/F emissions from the Spanish cement sector. Effect of conventional/alternative fuels".
- 151 European Commission (2003). "Reference Document on the General Principles of Monitoring".
- 152 Germany (2007). "Lime Manufacturing Industries - Reduction of NO<sub>x</sub> emissions at a rotary kiln with preheater by using the SNCR technique (practical experience)".
- 153 Castle Cement UK, P. W. (2007). "Application for variation to IPPC permit BL 1096, Solid Recovered Fuel (SRF) on kiln 4".
- 154 CEMEX UK (2006). "Application for a variation under PPC to allow use of a fuel known as Climafuel", Permit BL 7248.
- 155 Germany (2007). "Lime manufacturing industries - Co-incineration of waste".
- 156 Germany (2007). "Lime manufacturing industries - German example for the use of solid wastes as fuels in a rotary kiln (additions)".
- 157 Germany (2007). "Lime manufacturing industries - Minimisation of nitrogen oxide emissions by low NO<sub>x</sub> burners at annular shaft kilns".
- 158 Germany (2007). "Cement Manufacturing Industries - Duration and frequency of CO trips".
- 159 Ireland (2006). "Reports of CO emissions because of CO trips from cement plants in Ireland".
- 160 Germany (2007). "German experience with a 6 months SNCR performance test".
- 161 Austria (2006). "Operation and permit data from EIA from Austrian cement plants Wietersdorf (Wietersdorfer&Peggauer Zementwerke GMBH) and Retznei (Lafarge Perlmooser AG)".
- 162 A TEC (2006). "Modernisation of Wietersdorfer and Peggauer Zementwerke GmbH (CEMTECH Conference Rome 2006)".

## References

---

- 163 Castle Cement UK (2006). "Information on energy demand at Padeswood plant, Castle Cement UK".
- 164 Rheinkalk, W. F. (2007). "Beurteilung der Messungen von Emissionen und Verbrennungsbedingungen für den Zeitraum 01.01.2006 bis 31.12.2006, Kalk-Drehrohrofenanlage-Werk Flandersbach".
- 165 EUROMINES (2006). "Magnesia production from magnesite (natural process)".
- 166 European Union (1995). "Council Regulation (EC) no 384/96 of 22 December 1995 on protection against dumped imports from countries not members of the European Community", Official Journal L 056, 06/03/1996 P. 0001 - 0020.
- 167 European Union (2005). "Council Regulation (EC) No 778/2005 of 23 May 2005 imposing a definitive anti-dumping duty on imports of magnesia oxide originating on the People's Republic of China", Official Journal L 131 , 25/05/2005 P. 0001 - 0017.
- 168 TWG CLM (2007). "Merged and sorted comments master spread sheet on draft 1 and information".
- 169 Italy (2007). "Information on costs for PFRK (lime) provided with the comments for draft 1 of the revised BREF".
- 170 Austria (2007). "Contribution on waste input criteria 2007".
- 171 A TEC (2007). "Statement regarding energy use in the cement plant W&P in Austria".
- 172 France (2007). "Emissions of particles (PM 10 and PM 2.5) in the cement industry".
- 173 Germany (2007). "Abschlussbericht zum Forschungsprojekt: "Möglichkeit und Grenzen der SNCR Technik bei einer klassischen Drehofenanlage der Zementindustrie" im Zementwerk Harburg der Märker Zement GmbH".
- 174 EUCOPRO (2007). "Examples of waste input criteria from several EU Member States".
- 175 Lafarge (2007). "Information regarding SO<sub>x</sub> emissions at Retznei works in Austria".
- 176 France (2008). "Contributions regarding emerging techniques in the cement industry (reduction of SO<sub>x</sub>, dust emissions)".
- 177 EULA (2008). "Updated contributions regarding lime manufacturing, e.g. improvement on energy efficiency in lime kilns, figure on the lime manufacturing process, dust emissions data from UK (using wet scrubbers)".
- 178 CEMBUREAU (2008). "Use of waste fuels in cement kilns (Co-processing of waste in cement kilns) - Ökopol Waste Incineration Assessment".
- 179 European Commission (2006). "Reference Document on Economics and Cross-Media Effects".
- 180 Mauschwitz (2004). "Emissionen aus Anlagen der österreichischen Zementindustrie V".
- 181 European Commission (2008). "Reference Document on the Best Available Techniques in Energy Efficiency".
- 182 TWG CLM (2008). "Merged and sorted comments master spread sheet on second part of draft 1 and information".



- 183 Szednyj/Schindler (2005). "Minderungspotentiale der NEC-Gase und Staub bis 2010 der Österreichischen Zementindustrie", Berichte BE-261.
- 184 CEN standard EN-1948 (2007). "Stationary source emissions - Determination of the mass concentration of PCDD/PCDF and dioxin-like PCBs - Part 4: Sampling and analysis of dioxin-like PCBs".
- 185 Hackl und Mauschitz (2003). "Emissionen aus Anlagen der österreichischen Zementindustrie IV".
- 186 IAF (2010). International Accreditation Forum website <http://www.iaf.nu>.
- 187 ISO (2004). ISO 14001: 2004 [http://www.iso.org/iso/iso\\_14000\\_essentials.htm](http://www.iso.org/iso/iso_14000_essentials.htm).
- 188 DG Environment (2010). What is Emas? [http://ec.europa.eu/environment/emas/index\\_en.htm](http://ec.europa.eu/environment/emas/index_en.htm).
- 189 European Union (2009). "Regulation (EC) No 1221/2009 of the European Parliament and the Council of 25 November 2009 on the voluntary participation by organisations in a Community eco-management and audit scheme (EMAS), repealing Regulation (EC) No 761/2001 and Commission Decisions 2001/681/EC and 2006/193/EC".
- 190 ISO (2010). Technical committee 207 <http://www.tc207.org>.
- 191 European Union (2009). "Directive 2009/29/EC of the European Parliament and of the Council of 23 April 2009 amending Directive 2003/87/EC so as to improve and extend the greenhouse gas emission allowance trading scheme of the Community".
- 192 CEMBUREAU (2012): "Waste fuel groupings versus those of the EWC".
- 193 European Union (2007). "Commission Decision of 18 July 2007 establishing guidelines for the monitoring and reporting of greenhouse gas emissions pursuant to Directive 2003/87/EC of the European Parliament and of the Council".